

# SENCOR®

## SPT 280

USER'S MANUAL

UŽIVATELSKÁ PŘÍRUČKA

POUŽÍVATEĽSKÁ PRÍRUČKA

HASZNÁLATI ÚTMUTATÓ

INSTRUKCJA UŻYTKOWNIKA

РУКОВОДСТВО ПОЛЬЗОВАТЕЛЯ

NAUDOTOJO VADOVAS

PORTABLE PLL STEREO FM  
WITH CD/MP3/USB SYSTEM

PŘENOSNÉ RÁDIO  
S CD/MP3/USB PŘEHŘÁVAČEM

PRENOSNÉ RÁDIO  
S CD/MP3/USB PREHRÁVAČOM

HORDOZHATÓ RÁDÍÓ  
CD/MP3/USB LEJÁTSZÓVAL

PRZENOŚNE RADIO  
Z ODTWARZACZEM CD/MP3/USB

ПОРТАТИВНАЯ СТЕРЕОСИСТЕМА  
С FM-РАДИОПРИЕМНИКОМ С ФАЗОВОЙ  
АВТОПОДСТРОЙКОЙ ЧАСТОТЫ  
И ВОЗМОЖНОСТЬЮ ЧТЕНИЯ КОМПАКТ-  
ДИСКОВ/MP3/USB

NEŠIOJAMASIS PLL STEREOFONINIS FM  
RADIJAS SU CD/MP3/USB GROTVUV

EN CZ SK HU PL RU LT



**IMPORTANT:** Please read before using and keep for future reference.

## INTRODUCTION

- Thank you for buying this product.
- Please read through these operating instructions, so you will know how to operate your equipment properly. After you finished reading the instructions manual, put it in a safe place for future reference.

### CAUTION

Use of controls or adjustment or performance of procedures other than those specified herein may result in hazardous radiation exposure.

### DANGER

CLASS 1  
LASER PRODUCT

This Compact disc player is classified as a Class 1 LASER PRODUCT. THE CLASS 1 LASER PRODUCT label is located on the rear exterior.

**NOTE:** The manufacturer is not responsible for any radio or TV interference caused by unauthorized modifications.

- Avoid installing the unit in locations described below:
  1. Places exposed to direct sunlight or close to heat radiating appliances such as electric heaters, or other equipments that radiate too much heat.
  2. Places subjected to constant vibration.
  3. Unventilated or dusty places.
  4. Humid or moist places.
- Operate buttons and switches as instructed in the manual.
- Before turning on the power for the first time, make sure that the power cord is properly installed and the voltage switch is correctly set.
- Store your CD or other devices in a cool area to avoid damage from heat.

### CAUTION:

TO REDUCE THE RISK OF ELECTRIC SHOCK, DO NOT REMOVE COVER (OR BACK). DO NOT OPEN THE UNIT ANY SERVICING PLEASE REFER TO QUALIFIED SERVICE PERSONNEL.

### WARNING:

- Remove batteries if exhausted or if they will not be used for a long period.
- The incorrect use of batteries can cause electrolyte leakage and will corrode the compartment or cause the batteries to burst. Therefore:
- Do not mix battery types, e.g. alkaline with zinc carbonate.
- When inserting new batteries, replace all batteries at the same time.

# LOCATION OF CONTROLS

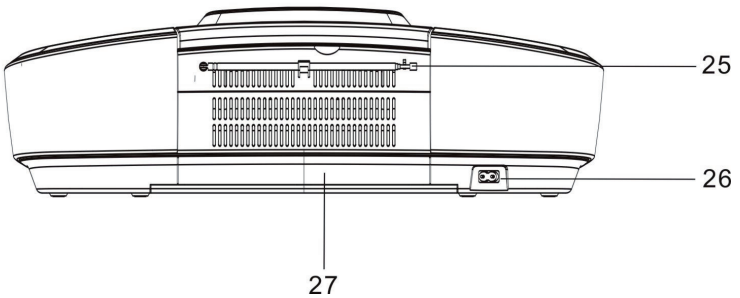
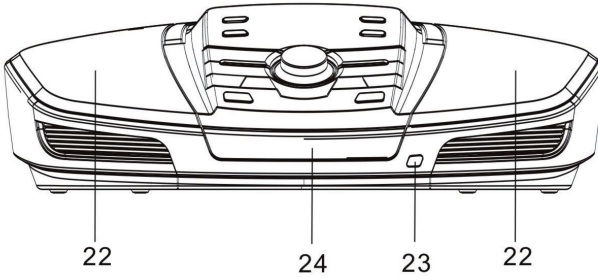
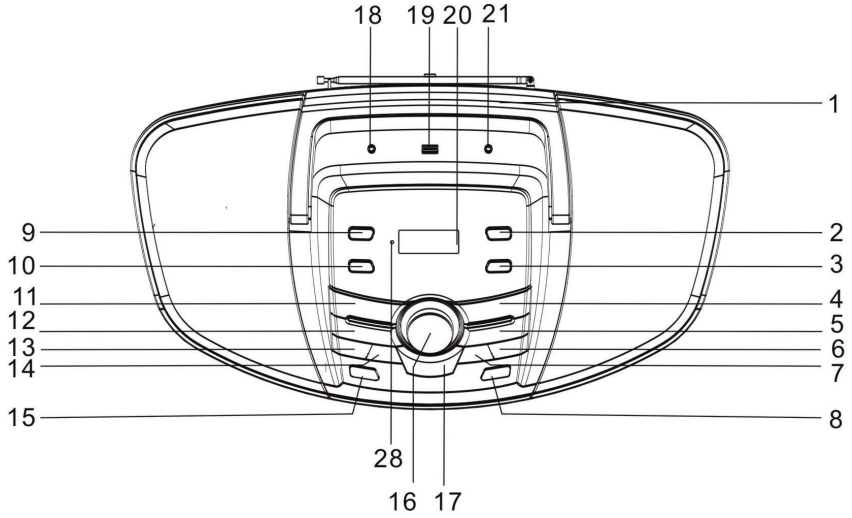

## NAMES OF CONTROLS

- |                                     |                           |
|-------------------------------------|---------------------------|
| 1. HANDLE                           | 15. STANDBY BUTTON        |
| 2. TIMER BUTTON                     | 16. VOLUME BUTTON         |
| 3. SET/ID3 BUTTON                   | 17. PROG./P-MODE BUTTON   |
| 4. MO/ST./■ BUTTON                  | 18. PHONES JACK           |
| 5. CD PLAY/PAUSE ►►   BUTTON        | 19. USB PORT              |
| 6. CD SKIP UP ►► / TUNING+ BUTTON   | 20. LCD DISPLAY           |
| 7. CD SKIP BACK ◀◀ / TUNING- BUTTON | 21. AUX IN JACK           |
| 8. OPEN/CLOSE BUTTON                | 22. SPEAKERS              |
| 9. SLEEP BUTTON                     | 23. REMOTE SENSOR         |
| 10. MEMORY BUTTON                   | 24. FRONT LOADING CD DOOR |
| 11. EQ BUTTON                       | 25. FM TELESCOPIC ANTENNA |
| 12. FUNCTION BUTTON                 | 26. AC SOCKET             |
| 13. FOLD./10/M- BUTTON              | 27. BATTERY COMPARTMENT   |
| 14. FOLD./10/M+ BUTTON              |                           |

## REMOTE HANDSET

### KEY FUNCTIONS:

1. FUNCTION KEY
2. TIMER KEY
3. MO/ST./■ KEY
4. CD SKIP BACK / TUNING- KEY
5. MEM/FOLD/10 DOWN KEY
6. MEM/PROG./P-MODE KEY
7. MUTE KEY
8. VOLUME DOWN KEY
9. VOLUME UP KEY
10. EQ KEY
11. ID3/PAIR KEY
12. MEM/FOLD/10 UP KEY
13. CD SKIP UP / TUNING+ KEY
14. CD PLAY/PAUSE / SET KEY
15. SLEEP KEY
16. STANDBY KEY
17. BATTERY COMPARTMENT
18. REMOTE SENSER

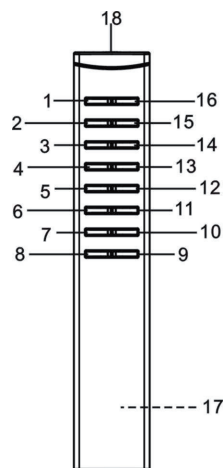

**Note:** Please pull battery protector before using.

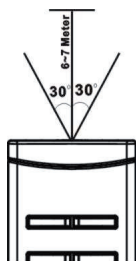

### REMOTE CONTROL OPERATION

To operate the unit with the remote control, point the remote handset at the remote sensor on the front panel and press the appropriate button on the remote handset. The remote works best within a range of 6 ~ 7 meters from the front panel and on an angle of 30 degrees. Bright sunlight or room light conditions can interfere with the remote control. If the remote operation is unsatisfactory or stops working entirely, first try replacing the remote batteries, then try reducing the room lighting conditions.

## BATTERY INSTALLATION OF REMOTE CONTROL

- The remote control is powered by two 1,5V batteries type AAA.
- To replace the battery, gently push the clasp to the right direction accordingly to the instruction and then pull out the battery compartment.

Take the drained battery out and install a new batteries 2 x 1,5V type AAA in the compartment with the positive polarity upwarded. Then push the compartment back to its position with a “click” sound indicating installation finished.

## POWER SOURCE

This unit is designed to be operated on AC/DC.

### AC OPERATION

Plug the tail of AC power cord into AC socket on unit and the plug into household AC outlet. The batteries will be automatically disconnected. For dual voltage version, make sure that the AC VOLTAGE SELECTOR is switched to your local voltage.

### DC OPERATION

Open the BATTERY COMPARTMENT DOOR. Install 8pcs UM-1/D size batteries (not included) into compartment. Please follow correct polarities as indicated.

#### CAUTION:

Remove batteries if they are flat or not being used for a long period of time. Batteries contain chemical substances, so they should be disposed of properly.

## BASIC FUNCTION

### Switching On The Unit

- After connecting the power, the display will show AM 0:00. Remain this mode , the unit would turn off automatically after 15 minutes. Press STANDBY button to turn on the unit and press STANDBY button again to play.

- **Setting the Time**

Note: Please make sure that all connections have been ready.

1. In standby mode the LCD display will flash 0:00. Press the SET/ID3 button, the display will show the RTC 12 hours or the RTC 24 hours version. Press SKIP UP ►►/DOWN ◀◀ button on unit or on remote to choose for the 12 or 24 hour version. Press the SET/ID3 button to confirm.
2. After confirm the hours system, the Hour digits will flash, press the ◀◀ or ►► button on unit or on remote repeatedly to set the clock to the correct Hour, press the SET/ID3 button to confirm. Then the minute digits will flash, press the ◀◀ or ►► button on unit on remote repeatedly to set the clock to the correct Minutes, press the SET/ID3 button again to confirm.

### Waking up the music (Radio/CD/USB)

You can set the timer to wake up the Radio, CD/MP3 or USB.

1. After setting the time in standby mode, press and hold the TIMER button on unit or press TIMER key on remote control to set the desired wake up time.
2. Enter the desired hour with the ◀◀ or ►► button, press the TIMER button on unit or on remote control to confirm. Enter the desired minutes with the ◀◀ or ►► button, press the TIMER button on unit or on remote control to confirm. Then choose the desired wake up mode (RADIO/CD/USB) by ◀◀ or ►► button and press TIMER button on unit or on remote control to confirm.
3. To the pre-set time, the desired wake up mode will turn on automatically.

## Sleep To Music Timer

You can set the sleep timer to automatically turn off the unit during playback after a set period of time (10, 20, 30... up to 90 minutes).

- 1) During operation, press the SLEEP button on unit or on remote control repeatedly to select the desired sleep time from 90 minutes to 10 minutes, then stop pressing when the desired sleep time come up, after about 5 seconds the sleep time will be automatically set and the "SLEEP" indicator show on the display.
- 2) The RADIO or CD/MP3 or USB or AUX player will continue playing until the sleep timer counts down to "00" and then turn off automatically.

**Note:** If you are falling asleep to CD/USB/AUX, the sound will stop when the disc ends, even if a longer sleep time was selected.

## Turning on the unit

Press the STANDBY button on unit or remote control, then press the FUNCTION button on unit or remote control to choose FM / CD / USB / AUX model.

## VOLUME ADJUSTING

Rotate the VOLUME button on unit or remote control to increase or decrease volume. Press MUTE button on remote control to turn off the sound. Press again to turn on.

## EQ FUNCTION

This unit has a built-in equalizer system, Press EQ button on unit or remote control while playing to select different music style (sound tone): FLA, JAZZ, ROC, CLASS and POP.

## ID3 System

When plays a MP3 file, press the SET/ID3 button on the unit or ID3 key on remote control, it will show "ID3 ON", if the MP3 file is "ID3" format, it will automatically search the information of "TITLE NAME" "ARTIST NAME" and "ALBUM NAME" and show on the display. Press the SET/ID3 button on the unit or ID3 key on remote control again to back to normal display.



## HEADPHONE JACK

For private listening, insert a 3.5mm headphone (not included) into the HEADPHONE jack. The SPEAKER output would be automatically cut off.

**CAUTION:** LISTENING AT A HIGH VOLUME OVER A LONG PERIOD IS NOT GOOD FOR YOUR EARS.

# RADIO OPERATION

## TUNING RADIO STATIONS

1. Press the FUNCTION button on unit or remote control to select the desired wave band: FM .
2. Tune to desired station by pressing the TUN+ / ►►► or TUN- / ◀◀◀, the display will show the band frequency. Example: **FM 97.10** MHz
3. Extend FM TELESCOPIC ANTENNA to its full length if you are listening to FM broadcasting. Gently rock the unit back and forth to get the best reception when you are listening to FM program, or place the unit in an open location.  
**Note:** The radio function is initially set at STEREO mode, if the broadcasting program is too noisy when you are listening to FM stereo station, press MO./ST./■ button on unit or press MO./ST./■ key on remote to switch to MONO FM.
4. To turn off the radio, press the FUNCTION button to switch to other functions or press STANDBY button to turn off the unit.

## RADIO STATION MEMORY OPERATION

You may pre-store 20 (FM ) radio stations in memory for your preference controlled by remote handset, so as you can listen to your desired station directly and quickly, no need to tuning and search for again.

1. Press FUNCTION button to FM mode.
2. Press MEMORY button on unit or press MEM/PROG./P-MODE key on remote, "P01 " will flash on the display. Then press the „TUN+ / ►►►“ or „TUN- / ◀◀◀“ button to select the first desired station.
3. Press the FOLD./10/M+ or FOLD./10/M- button on unit or - MEM/FOLD./10 + on remote to choose the desired sequence you want to store, then press MEMORY button on unit or press -MEM/PROG./P-MODE+ key on remote again to enter.
4. Search another station, repeat steps (2) & (3) until all desired stations stored. Up to 20 stations can be programmed.
5. Press the FOLD./10/M+ or FOLD./10/M- on unit or MEM/FOLD./10 UP/DOWN button on remote to listen to the stored station directly.

## CD/MP3 OPERATION

### Discs for Playback

This system can playback all digital audio CD/MP3, finalized digital audio CD-Recordable (CD-R) discs, finalized digital audio CD-Rewritable (CD-RW) discs and CD-DA format digital audio CD/CD-R/CD-RW discs.

### LOADING A DISC

1. Press the FUNCTION button on unit or remote control to select "CD" mode.
2. Press the OPEN/CLOSE button to open the CD door, "OPEN" will be shown on the display.
3. Place an audio CD/MP3 DISC into the tray with the front side facing up.
4. Close the CD door.  
The display will show a flashing " -- READING -- ", then the total number of tracks would be shown and the playback will start from track.
5. To remove the CD, press OPEN/CLOSE to open CD door, the display will show "OPEN ". Hold the CD by its edges, and take it out carefully.

#### Note:

- Make sure the disc is stopped before opening the CD DOOR.
- To ensure good system performance; wait until the unit completely reads the disc before proceeding.
- If no disc loaded into the tray, or the disc is unreadable, the display will show "NO DISC".

### PLAYING A DISC

1. The playback starts from track 1 automatically when reading the disc.  
To pause playback, press ►► button on unit or on remote. The current playing time will flash on the display.  
To resume playback, press ►► button on unit or on remote again.
2. To stop playback, press MO/ST./■ button on unit or on remote, the total number of tracks.

### SELECTING A DESIRED TRACK/PASSAGE



#### To select a desired track

Press the TUN+ / ►►► or TUN- / ◀◀◀ button on unit or remote respectively in stop mode or during playing until the desired track appears on the display. Press the ►► button on unit or on remote to start play.

#### To search for a particular passage during playback (track scanning at high speed)

Press and hold the TUN+ / ►►► or TUN- / ◀◀◀ button on unit or on remote to scan the current playing track at high speed until desired point (passage) appears, then release the button for normal playback mode. Playback will start again from this point.

### To select a song which track number exceeds 10



To select a song/track which number exceeds 10, Press the FOLD./10/M- or FOLD./10/M+ button on unit or -MEM/FOLD./10+ button on the remote control each time to skip backward or forward 10 tracks, then press the TUN+/ or TUN-/ button on unit or on remote to select desired track, for example: to select the 17<sup>th</sup> track from the 1<sup>st</sup> track, press FOLD./10/M+ button on unit or press MEM/FOLD./10 UP(12) key on remote, and then press the SKIP UP button on unit or on remote six times immediately.

### To select a desired folder (for MP3 disc that contains more than one folder)

To select a desired folder during playback, press and hold the FOLD./10/M+ or FOLD./10/M- button on unit or -MEM/FOLD./10+ button on the remote control to next /previous folder.

## PROGRAMING TRACKS

Programming tracks of disc are possible when playback is stopped. Up to CD 20 tracks /MP3 99 tracks can be stored in the memory in any order.

1. In stop mode, press the PROG./P-MODE button on unit or press MEM/PROG./P-MODE key on remote to enter program setting, the display will flash **PROG** and **P01 001**.
2. Press the TUN+/ button on unit or on remote to select the first desired track to be programmed. (example: track 2)
3. Press the PROG./P-MODE button on unit or press MEM/PROG./P-MODE key on remote to enter. The display would flash **PROG** and **P02 002**.
4. Repeat steps 2 & 3 to store other desired tracks until all tracks programmed.
5. Press the  button on unit or on remote to start playback from the first programmed track. The display will show **001** and the “ **PROG** ” indicator will light up on LCD display.
6. Press the MO/ST./ button on unit or on remote to stop program playback.



### To clear the program, you may

1. Press MO/ST./ button on unit or on remote when the disc stopped, and
2. Open the CD compartment lid, the program will be erased.



## REPEAT

You can play one track or all tracks on the disc repeatedly.



### To Repeat a Single Track

1. Press PROG./P-MODE button on unit or press MEM/PROG./P-MODE key on remote control during play, the display will show a flashing „“ and the current track will be played over and over again till you press the MO/ST./ button on unit or on remote.
2. To cancel repeat play, press PROG./P-MODE button on unit or press MEM/PROG./P-MODE key on remote control until „“ disappears from the display.

### To repeat all the Tracks

1. Press PROG./P-MODE button on unit or press MEM/PROG./P-MODE key on remote control until the „ ALL“ shows steady on the display, all tracks on the disc will be played over and over again till you press the MO/ST./ button on unit or on remote.
2. To cancel repeat play, press the PROG./P-MODE button on unit or press MEM/PROG./P-MODE key on remote control until „ ALL“ disappears from the display.

### To repeat the folder (only for MP3 disc which contains more than one folder)

1. Press the PROG./P-MODE button on unit or press MEM/PROG./P-MODE key on remote control until „ DIR“ show steady on the display, the current folder will be repeated over and over again till you press the MO/ST./ button on unit or on remote.
2. To cancel repeat play, press the PROG./P-MODE button on unit or press MEM/PROG./P-MODE key on remote control until „ DIR“ and the local folder disappear from the display.

## RANDOM PLAY

Press the PROG./P-MODE button on unit or press MEM/PROG./P-MODE key on remote control in play mode till the "RAN" shows steady on the display, the random play will start from next track automatically, until all tracks are played over and then it will stop. Press the PROG./P-MODE button on unit or press MEM/PROG./P-MODE key on remote control again until the "RAN" disappears from the display to cancel.

## USB OPERATION

1. Press the FUNCTION button on unit or on remote to select "USB" mode.
2. Connect the USB to the USB INPUT. The LCD will show the total number of tracks stored in the USB. The playback starts from track 1 automatically after reading the USB.
3. Press the MO/ST./■ button on unit or on remote to stop playing. The display will show total number of USB and STOP.
4. Proceed repeat play (repeat 1- repeat folder - repeat all)/program play/skip up and back operation as the same described in above "CD/MP3 OPERATION".

### CAUTION:

- Do not use any USB extension cable for connecting the USB bar which may cause harmful interference

## AUX OPERATION

1. Press the FUNCTION button to select "AUX" mode.
2. Insert the AUX line plug into the AUX IN jack(Φ3.5mm) on the player, music from the device would be amplified and exported from the speakers.
3. Adjust the volume of the main unit to your desired level.
4. Press PLAY of the external audio source (eg. MP3 player) to start playback.

## COMPACT DISC MAINTENANCE

1. Always use a compact disc bearing the mark as shown.
2. Notes on handling discs
  - Removing the disc from its storage case and loading it.
  - Do not touch the reflective recorded surface.
  - Do not stick paper or write anything on the surface.
  - Do not bend the disc.
3. Storage
  - Store the disc in its case.
  - Do not expose discs to direct sunlight or high temperatures, high humidity or dusty places.
4. Cleaning a disc
  - Should the disc become soiled, wipe off dust, dirt and fingerprints with a soft cloth.
  - The disc should be cleaned from the center to the edge.



CORRECT



INCORRECT



- Never use benzene, thinners, record cleaner fluid or anti-static spray.
- Be sure to close the CD door, so the lens is not contaminated by dust.
- Do not touch the lens.

## SPECIFICATIONS

<b>GENERAL</b>	
Power Requirement	AC 230 V ~ 50 Hz
	DC 12V UM-1/D x 8pcs
Power consumption	40 Watts
Weight	3.5 kg
Dimensions	513 (L) x 287(W) x 162 (H) mm
Operation temperature	+ 5 °C - + 35 °C

<b>RECEIVER SECTION</b>	
Receiving Bands	FM/FM ST.
Frequency Range	FM 87.5 – 108 MHz

<b>COMPACT DISC SECTION</b>	
Optical Pickup	3-Beam Laser
Frequency Response	100Hz – 16KHz

<b>AUDIO SECTION</b>	
Power output	8W x 2 (RMS)

<b>ACCESSORIES</b>	
Instruction Booklet	1
Remote Handset	1
AC Cord	1

Specifications are subject to change for continuous improvement, we reserve the rights to modification without prior notice.

## INSTRUCTIONS AND INFORMATION REGARDING THE DISPOSAL OF USED PACKAGING MATERIALS

Dispose of packaging material at a public waste disposal site.



### DISPOSAL OF USED ELECTRICAL AND ELECTRONIC APPLIANCES

The meaning of the symbol on the product, its accessory or packaging indicates that this product shall not be treated as household waste. Please, dispose of this product at your applicable collection point for the recycling of electrical & electronic equipment waste. Alternatively in some states of the European Union or other European states you may return your products to your local retailer when buying an equivalent new product. The correct disposal of this product will help save valuable natural resources and help in preventing the potential negative impact on the environment and human health, which could be caused as a result of improper liquidation of waste. Please ask your local authorities or the nearest waste collection centre for further details. The improper disposal of this type of waste may fall subject to national regulations for fines.

#### For business entities in the European Union

If you wish to dispose of an electrical or electronic device, request the necessary information from your seller or supplier.

#### Disposal in other countries outside the European Union

If you wish to dispose of this product, request the necessary information about the correct disposal method from local government departments or from your seller.



The product meets EU requirements.

Hereby, FAST ČR, a.s. declares that the radio equipment type SPT 280 is in compliance with Directive 2014/53/EU. The full text of the EU declaration of conformity is available at the following internet address: [www.sencor.eu](http://www.sencor.eu)

Changes to the text, design and technical specifications may occur without prior notice and we reserve the right to make these changes.

# SENCOR®

## EN Warranty conditions

Warranty card is not a part of the device packaging.

This product is warranted for the period of 24 months from the date of purchase to the end-user. Warranty is limited to the following conditions. Warranty is referred only to the customer goods using for common domestic use. The claim for service can be applied either at dealer's shop where the product was bought, or at below mentioned authorized service shops. The end-user is obligated to set up a claim immediately when the defects appeared but only till the end of warranty period. The end user is obligated to cooperate to certify the claiming defects. Only completed and clean (according to hygienic standards) product will be accepted. In case of eligible warranty claim the warranty period will be prolonged by the period from the date of claim application till the date of taking over the product by end-user, or the date the end-user is obligated to take it over. To obtain the service under this warranty, end-user is obligated to certify his claim with duly completed following documents: receipt, certificate of warranty, certificate of installation.

### **This warranty is void especially if apply as follows:**

- Defects which were put on sale.
- Wear-out or damage caused by common use.
- The product was damaged by unprofessional or wrong installation, used in contrary to the applicable instruction manual, used in contrary to legal enactment and common process of use or used for another purpose which has been designed for.
- The product was damaged by uncared-for or insufficient maintenance.
- The product was damaged by dirt, accident of force majeure (natural disaster, fire, and flood).
- Defects on functionality caused by low duality of signal, electromagnetic field interference etc.
- The product was mechanically damaged (e.g. broken button, fall).
- Damage caused by use of unsuitable media, fillings, expendable supplies (batteries) or by unsuitable working conditions (e.g. high temperatures, high humidity, quakes).
- Repair, modification or other failure action to the product by unauthorized person.
- End-user did not prove enough his right to claim (time and place of purchase).
- Data on presented documents differs from data on products.
- Cases when the claiming product cannot be indentified according to the presented documents (e.g. the serial number or the warranty seal has been damaged).

### **Authorized service centers**

Visit [www.sencor.eu](http://www.sencor.eu) for detailed information about authorized service centers.