

Body-Solid

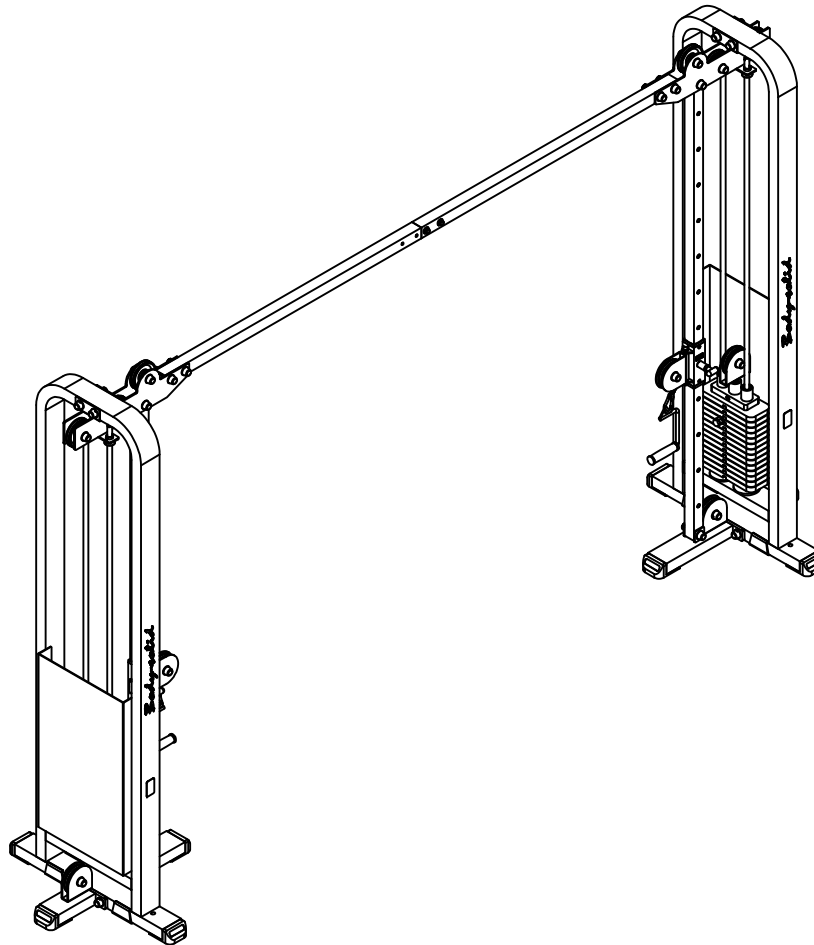

BODY-SOLID, Inc.
1900 S. Des Plaines Ave.
Forest Park, IL 60130 USA
Phone: (708) 427-3555
Fax: (708) 427-3556
www.bodysolid.com

SCC-1200G.1 OWNER'S MANUAL

Warning, Safety & Maintenance

Be sure that all users carefully read and understand all warning, safety and maintenance labels on the machine before each use. Failure to do so may result in death or serious injury.

It is imperative that you retain your Owner's Manual and be sure all warning labels are legible and intact. Replacement Owner's Manuals and warning labels are available from your local Body-Solid dealer.

If you have any questions about the operation, set up or maintenance of this machine please call our customer service department at 1 (800) 556-3113.

THERE IS A RISK ASSUMED BY INDIVIDUALS WHO USE THIS TYPE OF EQUIPMENT. TO MINIMIZE RISK, YOU MUST FOLLOW THESE RULES:

1. Inspect equipment before each workout. Check that all nuts, bolts, screws and pop pins are in place and fully tightened. Also, before use, check cables for signs of wear. Replace all worn parts immediately. Never use machine if any parts are damaged or missing. **FAILURE TO FOLLOW THESE RULES MAY RESULT IN SERIOUS INJURY.**
2. Keep clear of the cables and all moving parts when the machine is in use.
3. Always make sure all Snap Links are closed when doing any cable/pulley/strap exercises.
4. Exercise with care. Perform your exercises at a smooth moderate pace; never perform jerky or uncoordinated movements that may cause injury.
5. It is recommended that you should workout with a training partner.
6. Do not allow children or minors to play on or around this equipment.
7. If unsure of proper use of equipment, call your local Body-Solid distributor or the Body-Solid customer service department at 1-800-556-3113.
8. **WARNING:** Consult your physician before starting your exercise program. For your own safety, do not begin any exercise program without proper instruction. RAL8-6-03 WC-54

WARNING

Safety and Maintenance of Cables

IMPORTANT: Cables are wear items. It is your responsibility to prevent unexpected breakage. **Cable inspection should be performed daily.** Inspect all cables, the nylon coating on all cables, and the area near the fitting at each end of each cable. **Replace any damaged or worn cable immediately.** Do not allow the machine to be used until damaged or worn cables are replaced. Using or allowing a machine to be used with a suspect cable can result in serious injury. See Owner's Manual for more information.

For Body-Solid Customer Service
Call 1-800-556-3113

| MAINTENANCE SCHEDULE | | D A I L Y | W E E K L Y |
|--|---|-----------------------|----------------------------|
| Check the function and integrity of the following components. As noted, inspect equipment before each workout. Replace all damaged, broken or worn components immediately. | | | |
| Cables: | Check tension, end fittings, and coating | ✓ | |
| | Check that locking nut at weight stack is tight | | ✓ |
| Upholstery: | Wipe down and dry | ✓ | |
| | Clean and condition | | ✓ |
| Frame: | Wipe down and dry | ✓ | |
| | Polish / Wax | | ✓ |
| Chrome: | Wipe down and dry | ✓ | |
| | Polish / Lubricate | | ✓ |
| Nuts / Bolts / Fasteners: | Tighten and / or adjust as needed | | ✓ |
| Guide Rods: | Lubricate and clean | | ✓ |
| Linear Rods: | Lubricate and clean | | ✓ |
| Seat Sleeves: | Lubricate and clean | | ✓ |
| Adjustments / Locking Pins / Tightening Knobs | | | ✓ |
| Weight Stack Pins | | | ✓ |
| Warning Instruction Labels | | | ✓ |
| Springs / Pop Pins | | ✓ | |
| Anti Skid Surfaces | | | ✓ |
| Hand Grips / Rollers | | | ✓ |

For Body-Solid Customer Service
Call 1-800-556-3113
#MSSTR0803



Important Safety Instructions

Before beginning any fitness program, you should obtain a complete physical examination from your physician.

*Il est conseillé de subir un examen médical complet avant d'entreprendre tout programme d'exercice.
Si vous avez des étourdissements ou des faiblesses, arrêtez les exercices immédiatement.*

Antes de comenzar cualquier programa de ejercicios, deberías tener un examen físico con su doctor.

When using exercise equipment, you should always take basic precautions, including the following:

- Read all instructions before using your machine. These instructions are written to ensure your safety and to protect the unit.
- **Do not remove any safety labels from the machine.**
- Do not allow children on or near the equipment.
- Use the equipment only for its intended purpose as described in this guide. Do not use accessory attachments that are not recommended by the manufacturer. Such attachments might cause injuries.
- Wear proper exercise clothing and shoes for your workout, no loose clothing.
- Keep hands, limbs, loose clothing, and long hair well out of the way of all moving parts.
- Use care when getting on or off the unit.
- Do not overexert yourself or work to exhaustion.
- If you feel any pain or abnormal symptoms, stop your workout immediately and consult your physician.
- Never operate unit when it has been dropped or damaged. Return the equipment to a service center for examination and repair.
- Never drop or insert objects into any opening in the equipment.
- **IMPORTANT:** Cables are wear items. It is your responsibility to prevent unexpected breakage. Cable inspection should be performed daily. Inspect all cables, and the area near the fitting at each end of each cable. Replace any damaged or worn cable immediately. Do not allow the machine to be used until these are replaced.

- Do not use the equipment outdoors or near water.

Personal Safety During Assembly

- Before beginning assembly, please take the time to read the instructions thoroughly.
- Read each step in the assembly instructions and follow the steps in sequence. Do not skip ahead. If you skip ahead, you may learn later that you have to disassemble components and that you may have damaged the equipment.
- Assemble and operate your machine on a solid, level surface. Locate the unit a few feet from the walls or furniture to provide easy access.

Your machine is designed for your enjoyment. By following these precautions and using common sense, you will have many safe and pleasurable hours of healthful exercise.

After assembly, you should check all functions to ensure correct operation. If you experience problems, first recheck the assembly instructions to locate any possible errors made during assembly. If you are unable to correct the problem, call the dealer from whom you purchased the machine or call **1-800-556-3113** for the dealer nearest you.

Obtaining Service

Please use your Owner's Manual to make sure that all parts have been included in your shipment. When ordering parts, you must use the part number and description from your Owner's Manual. Use only Body-Solid replacement parts when servicing this machine. Failure to do so will void your warranty and could result in personal injury.

For information about product operation or service, check out the official Body-Solid website at www.bodysolid.com or contact an authorized Body-Solid dealer or a Body-Solid factory-authorized service company or contact Body-Solid customer service at one of the following:

Toll Free: 1-800-556-3113
Phone: 1-708-427-3555
Fax: 1-708-427-3556
Hours: M-F 8:30-5:00 CST
E-Mail: service@bodysolid.com

**Or write to: Body-Solid, Inc.
Service Department
1900 S. Des Plaines Ave.
Forest Park, IL 60130 USA**

Retain this Owner's Manual for future reference. If you need to order replacement parts please be prepared to provide the following information when contacting us so that we can assist you better.

- 1. Model Number**
- 2. Proof of Purchase**
- 3. Place of Purchase**
- 4. Serial Number (S/N)**
- 5. Part # and Description**



SCC-1200G ASSEMBLY INSTRUCTIONS

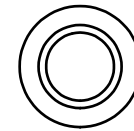
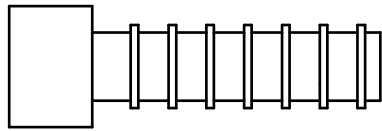

(A1)ROUND ALLEN HEAD 7/16"x1-1/2"L PARTIAL THREAD QTY.2

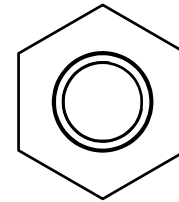
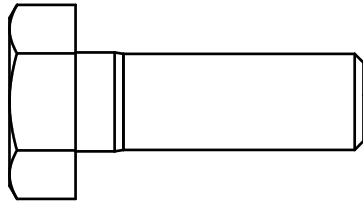

(A2)HEX BOLT 1/2"x1 1/2"L-13UNC PARTIAL THREAD QTY.2

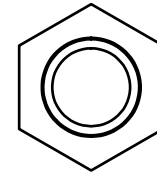
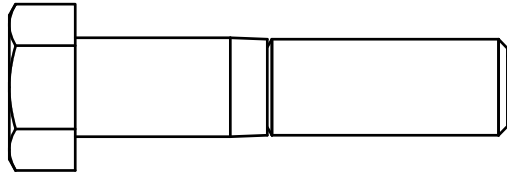

(A3)HEX BOLT 1/2"x2 1/4"L PARTIAL THREAD QTY.8

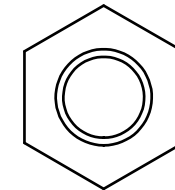
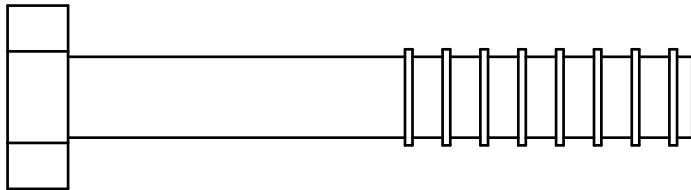

(A4)HEX BOLT 1/2"x3 1/4"L PARTIAL THREAD QTY.14

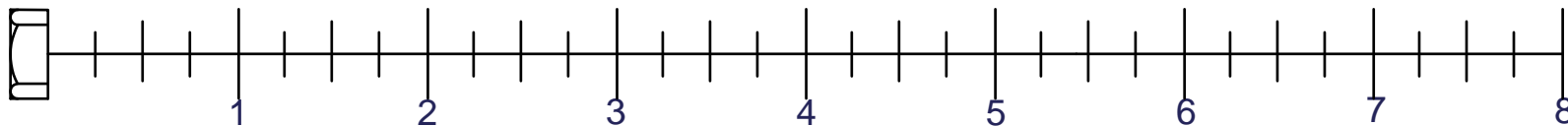



SCC-1200G ASSEMBLY INSTRUCTIONS

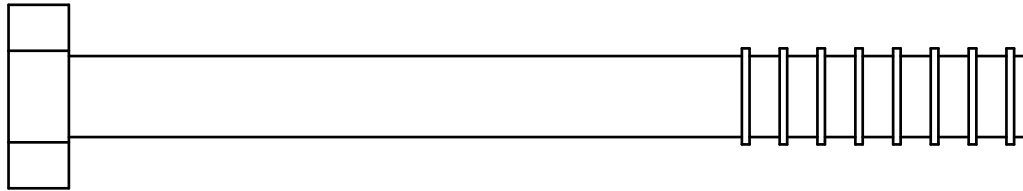

(A5)HEX BOLT 1/2"x5"L PARTIAL THREAD QTY.4

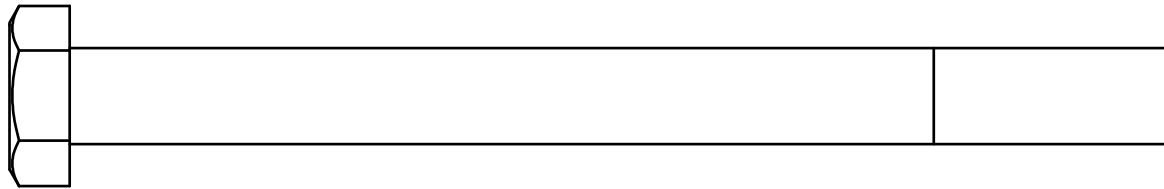

(A6)HEX BOLT 1/2"x5 3/4"L PARTIAL THREAD QTY.4

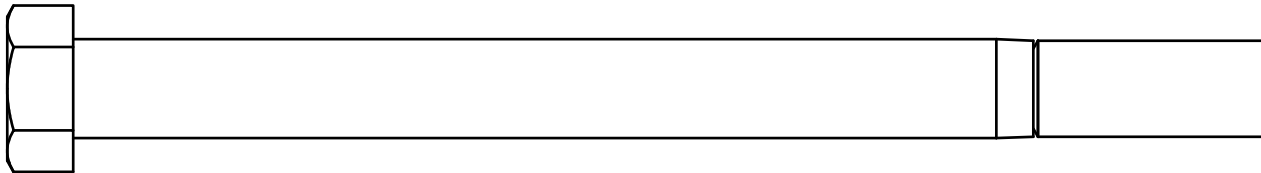

(A7)HEX BOLT 1/2"x6 1/4"L PARTIAL THREAD QTY.2

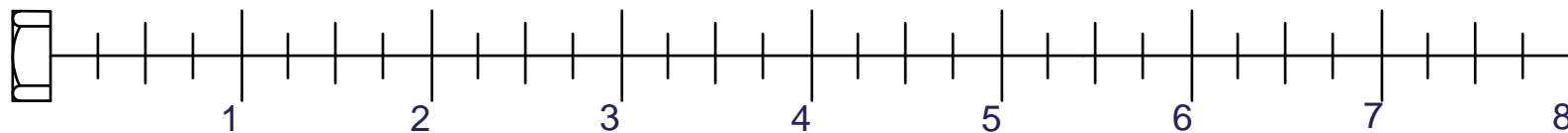



SCC-1200G ASSEMBLY INSTRUCTIONS

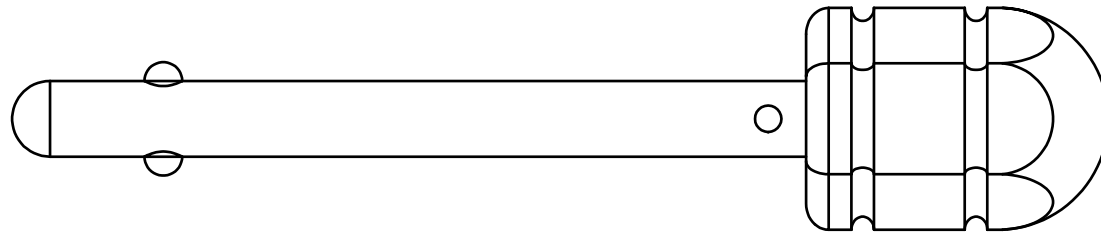

(A8)10LB PIN(8250-021) QTY.2

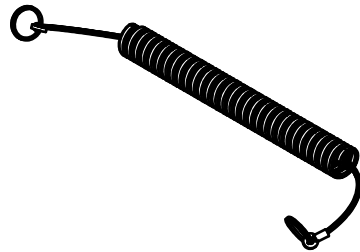

(A9)ELASTIC BOLT QTY.2

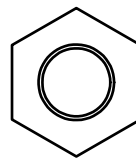
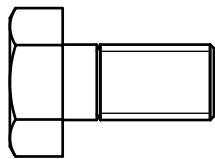

(A10)HEX BOLT M10X20L PARTIAL THREAD QTY.6

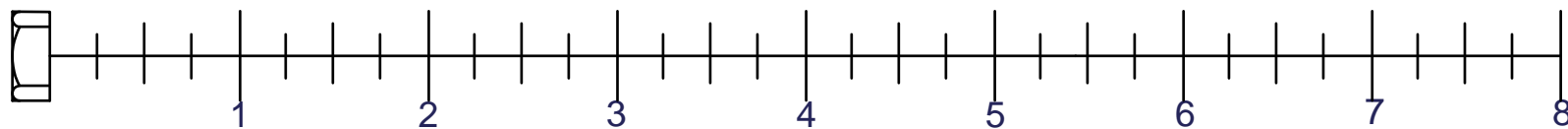



SCC-1200G ASSEMBLY INSTRUCTIONS

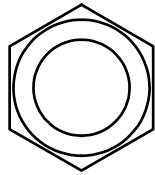
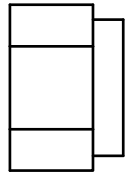

(B1) NYLON LOCK NUT 1/2" QTY.32

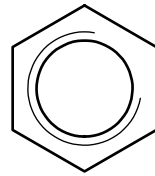
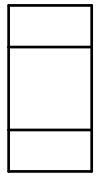

(B2) LOCK NUT 1/2"-13UNC QTY.2

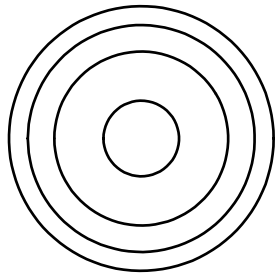

(C1) 1/2"(I.D.) ROUND END CAP WASHER QTY.60

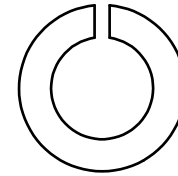

(C2) 1/2"(I.D.) SPRING WASHER QTY.2

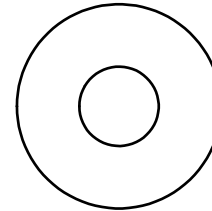

(C3) M10(I.D.) FLAT WASHER Ø27 QTY.6

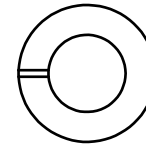

(C4) M10 SPRING WASHER QTY.6



SCC-1200G ASSEMBLY INSTRUCTIONS

HARDWARE ILLUSTRATION

- D1. 1/2" BOLT CAP(9212-024)-----[60PCS]
- D2. Ø4 1/2" PULLEY(9213-010A)-----[6PCS]
- D3. Ø4 1/2" PULLEY(9213-010B)-----[8PCS]
- D4. 2"x4" FOOT CAP(9211-028)-----[8PCS]
- D5. Ø4" RUBBER DOUNT(9310-017)-----[4PCS]
- D6. STIRRUP HANDLE(8290-002)-----[2PCS]
- D7. SPRING SNAP LINK(8810-001)-----[2PCS]
- D8. Ø3/4" SHAFT COLLAR(9211-050)-----[4PCS]
- D9. WEIGHT SELECTOR BAR(8220-061)-----[2PCS]
- D10. CHROME TOP PLATE(8400-002)-----[2PCS]
- D11. 8300mm STEEL CABLE-----[2PCS]
- D12. 60X50 NYLON BUSHING(9211-033)-----[4PCS]
- D13. Ø5/8" ROUND END CAP(9211-015)-----[4PCS]
- D14. 2"x4" RUBBER DOUNT(9212-009)-----[4PCS]

D4

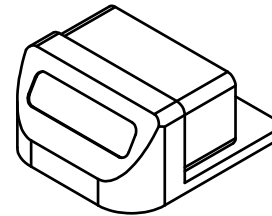

D5

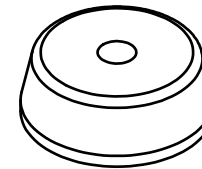

D6

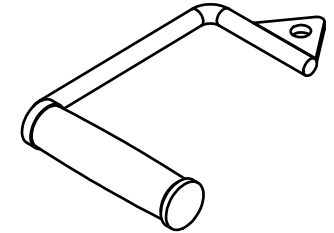

D7



D8



D9

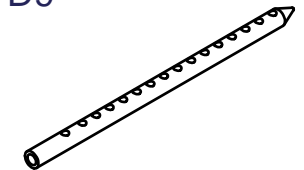

D1



D2

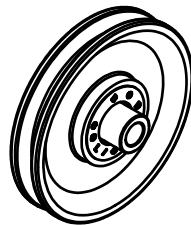

D3

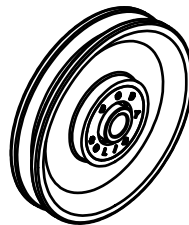

D10

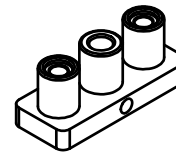

D11

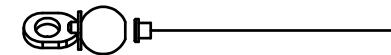

D12

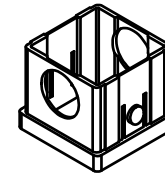

D13



D14

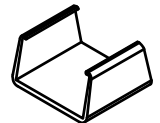



SCC-1200G ASSEMBLY INSTRUCTIONS

PARTS ILLUSTRATION SHEET

A[2PCS] WEIGHT STACK FRAME

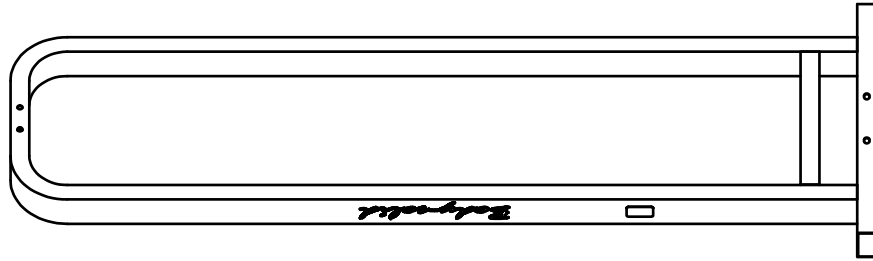

D[2PCS] TOP PULLEY FRAME

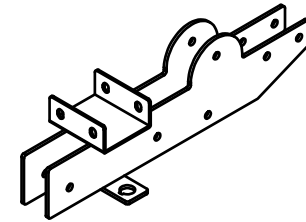

B[2PCS] UPRIGHT PILLAR

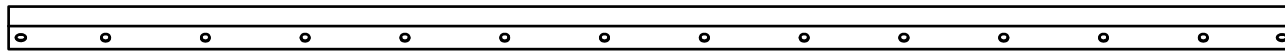

E[2PCS] BOTTOM PILLAR FRAME

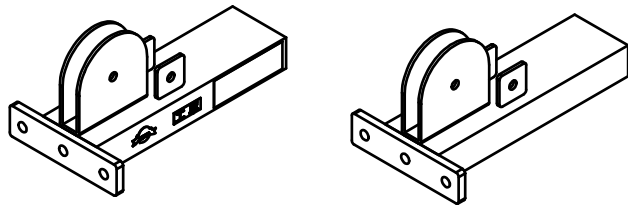

F[2PCS] BOTTOM PULLEY FRAME

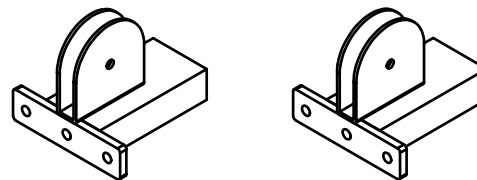

G[2PCS] MIDDLE PULLEY HOLDER

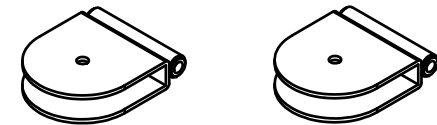



SCC-1200G ASSEMBLY INSTRUCTIONS

HARDWARE ILLUSTRATION

H[1PCS]
ADJUSTABLE CROSSOVER FRAME

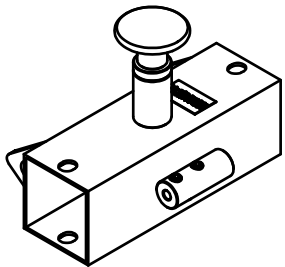

J[2PCS]8323-014
TOP PLATE PULLEY FRAME



L[2PCS]9220-009
PROTECT PLABK

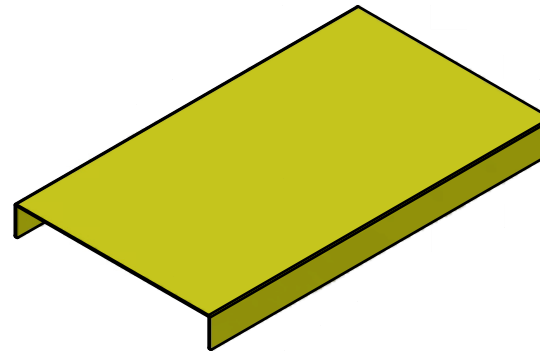

I[4PCS]8280-004
CHROME GUIDE ROD

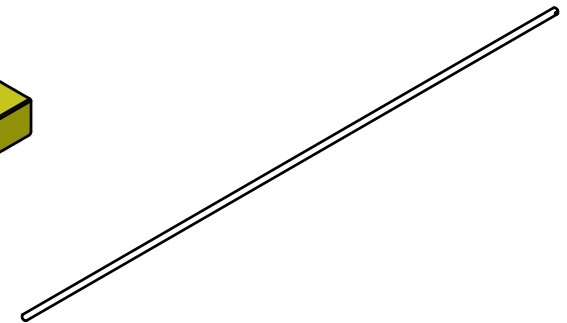

K[1PCS]
ADJUSTABLE CROSSOVER FRAME

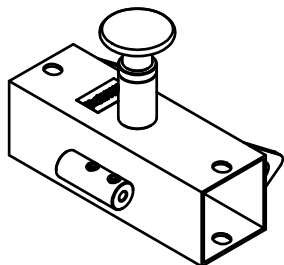

M[1PCS]

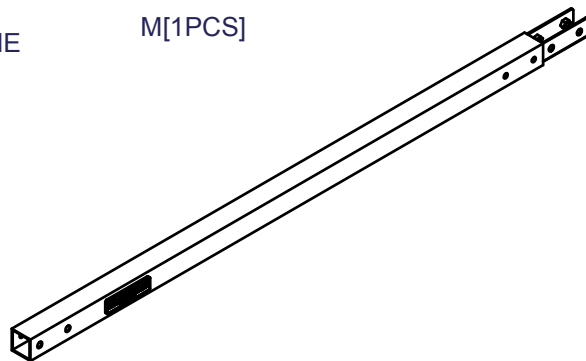

N[1PCS]
□50X2.5TX1370L

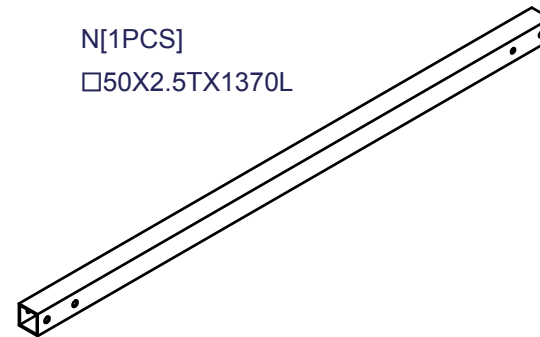



CABLE CROSSOVER

NOTE: DO NOT TIGHTEN NUTS
AND BOLTS SECURELY UNTIL YOU HAVE COMPLETED ALL ASSEMBLY STEP

Step - 1

- *Attach D14 Rubber Dount's to Bottom of A Weight Stack Frame.
- *Insert D4 Foot Cap's into ends of E Bottom Pillar Frame,
F Bottom Pulley Frame and A Weight Stack Frame.
- *Attach E Bottom Pillar Frame and F Bottom Pulley Frame to A Weight Stack Frame.

Step - 2

- *Attach I Chrome Guide Rod's and D5 Rubber Donut's to A Weight Stack Frame.
- *In this order slide Weight Stack, D10 Chrome Top Plate,
and D8 Shaft Collar's onto I Chrome Guide Rod's.
- *Insert D Top Pulley Frame onto I Chrome Guide Rod's and then attach to A Weight Stack Frame.
- *Insert D8 Shaft Collar's into D Top Pulley Frame.
- *Repeat all the steps above in order to assemble opposite side.

Step - 3&4 - Use this step on both sides

- *Attach D3 Pulley to G Middle Pulley Holder.
- *Attach G Middle Pulley Holder to K or H Adjustable Crossover Frame.
- *Insert D12 Nylon Bushing's to both sides of K or H Adjustable Crossover Frame.
- *Slide K or H Adjustable Crossover Frame onto B
Upright Pillar - Pull red mushroom cap adjuster to slide on.
- *Attach B Upright Pillar to E Bottom Pillar Frame and D Top Pulley Frame
- *Attach C Top Cross Support to D Top Pulley Frame

Step - 5 - Use this step on both sides

- *Attach J Top Plate Pulley Frame and small ring of A9 Elastic Bolt to D9 Weight Selector Bar.
- *Attach D3 Pulley to J Top Plate Pulley Frame.
- *Attach D9 Weight Selector Bar to D10 Chrome Top Plate.
- *Attach large ring of A9 Elastic Bolt to A8 10Lb. Pin.
- *Attach D3 Pulley to E Bottom Pillar Frame.
- *Attach D3 Pulley to F Bottom Pulley Frame.

Step - 6 - Use this step on both sides.

- *Attach D2 Pulley to inside of D Top Pulley Frame.
- *Attach D3 Pulley to outside of D Top Pulley Frame.
- *Attach D6 Stirrup Handle to H and K Adjustable Crossover Frame.

Step - 7

- *Attach Cables as shown in cable routing instructions.
- *Tighten all Bolts
- *Attach all Bolt Caps and L Protect Plate.

SAFETY RULES

1. Periodically check that all nuts, bolts and screws are fully tightened on your CABLE CROSSOVER MACHINE.
2. Exercise with care. Perform your exercises at a smooth moderate pace; never perform jerky or uncoordinated movements that may cause injury.
3. It is recommended that you should workout with a training parther.
4. **Warning:** CONSULT YOUR PHYSICIAN BEFORE STARTING YOUR EXERCISE PROGRAM. IT IS ADVISABLE TO HAVE A PHYSICAL EXAMINATION BEFORE YOU ENTER ANY EXERCISE PROGRAM. FOR YOUR OWN SAFETY, DO NOT BEGIN ANY EXERCISE WITHOUT PROPER INSTRUCTION.



SCC-1200G ASSEMBLY INSTRUCTIONS

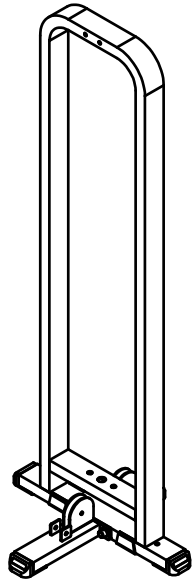

Above shows STEP 1 assembled and completed

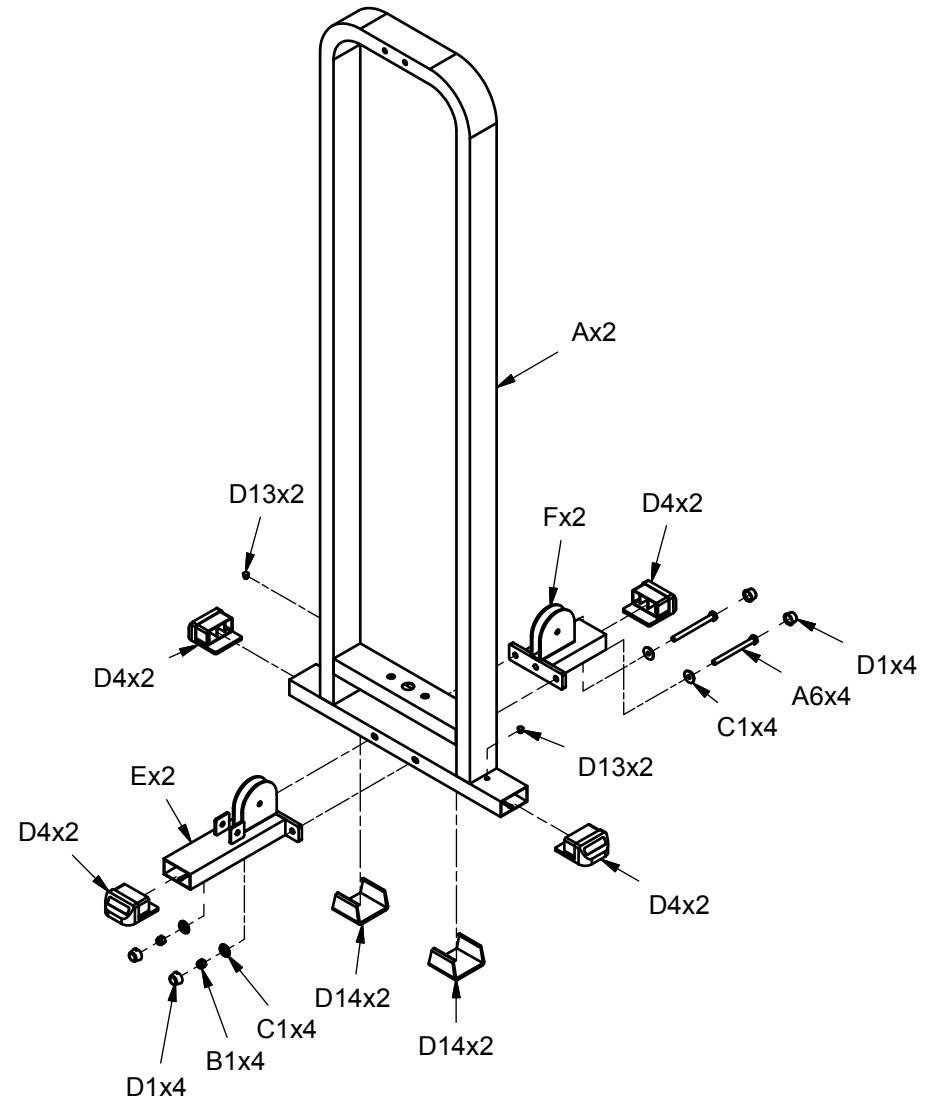
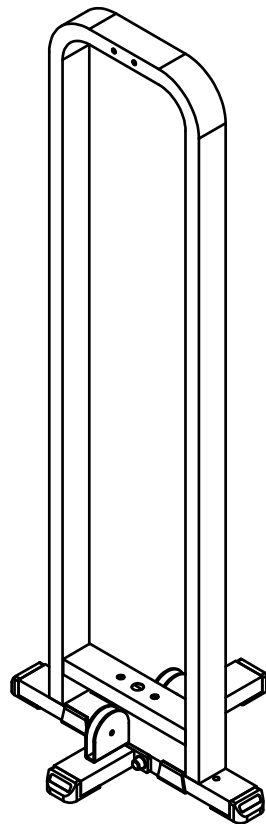

SCC-1200G ASSEMBLY INSTRUCTIONS

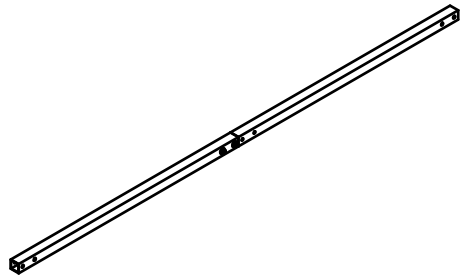

Above shows STEP 3 assembled and completed

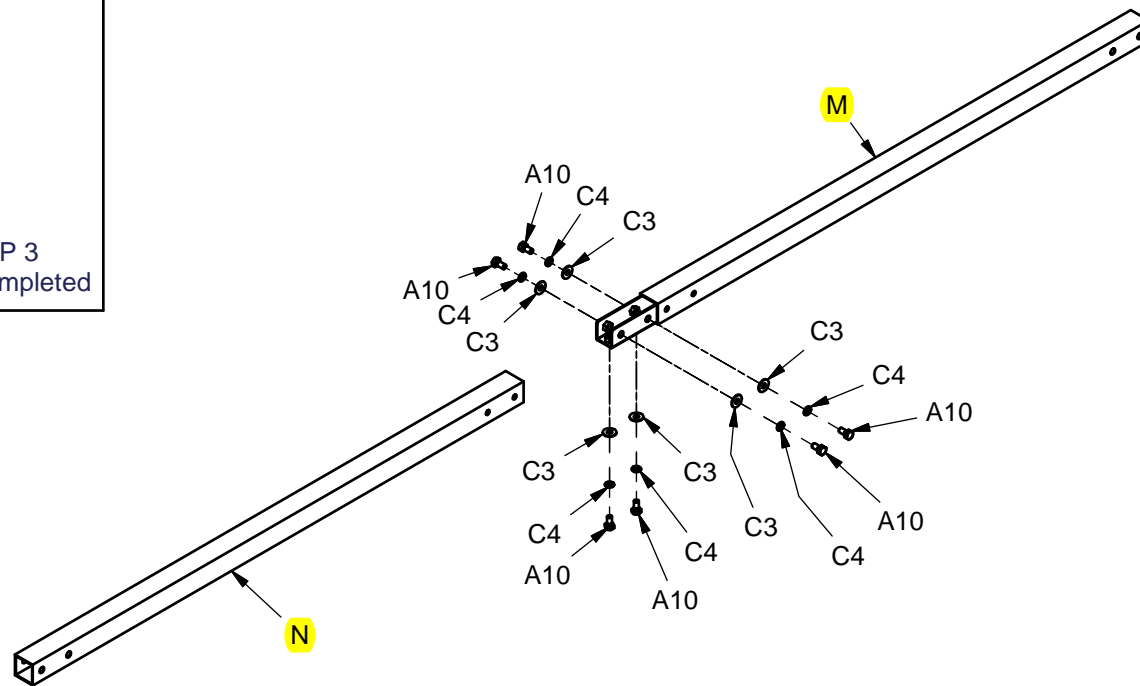



SCC-1200G ASSEMBLY INSTRUCTIONS

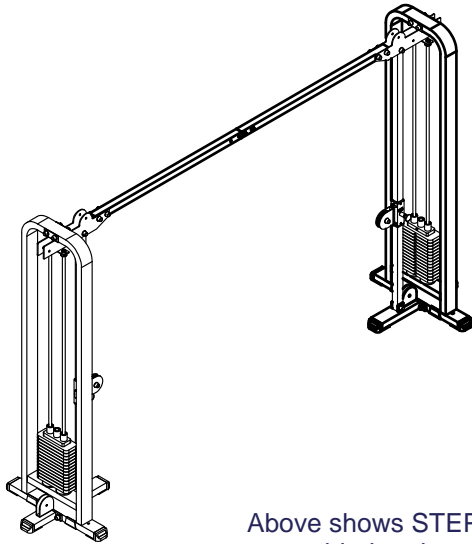

Above shows STEP 4 assembled and completed

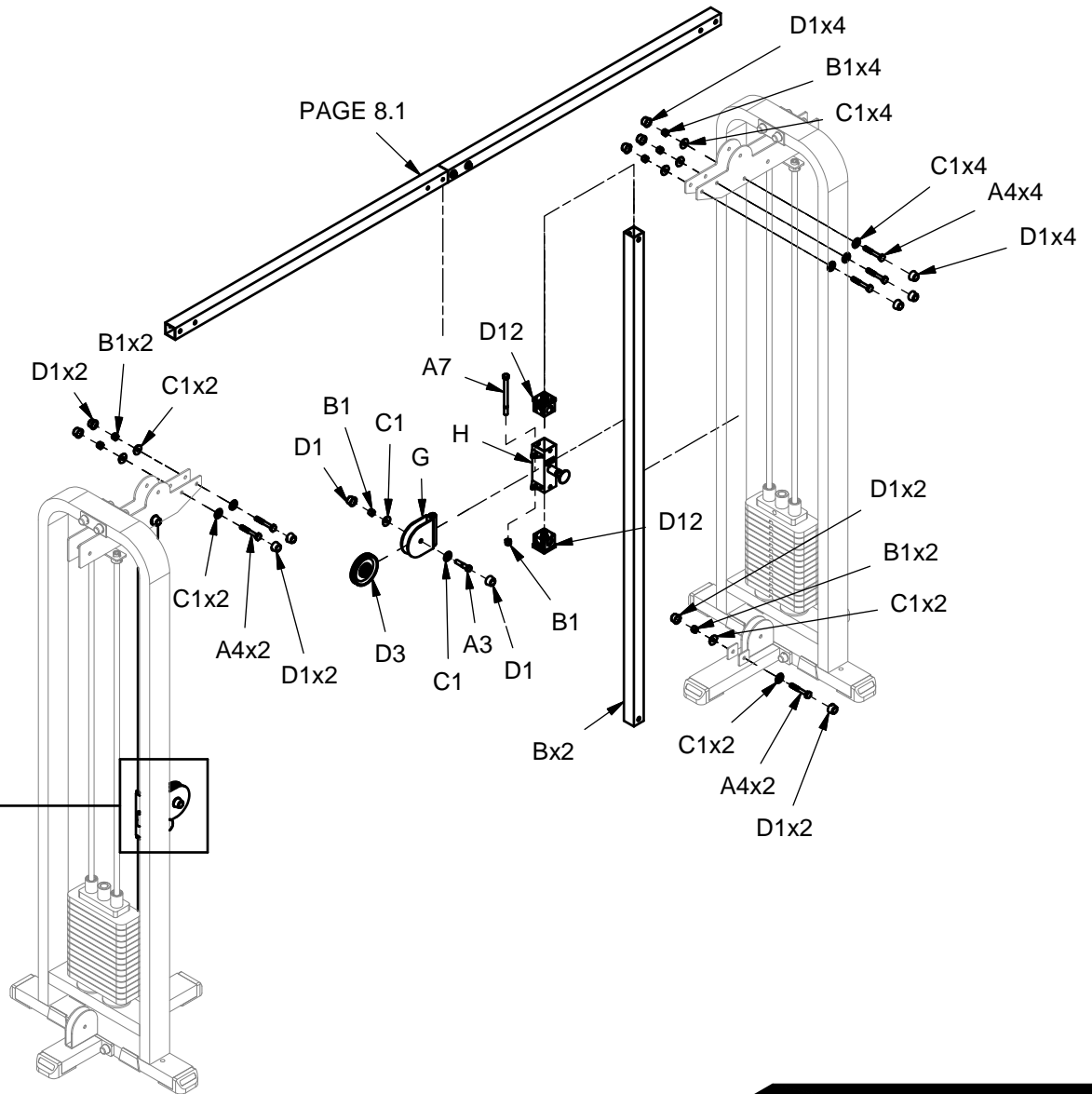
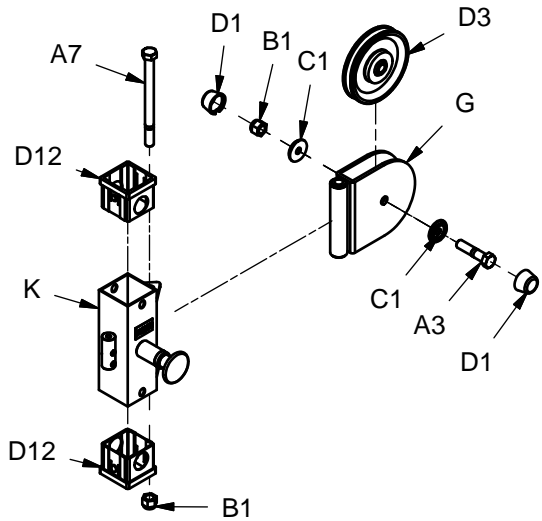

PAGE 8.1





SCC-1200G ASSEMBLY INSTRUCTIONS

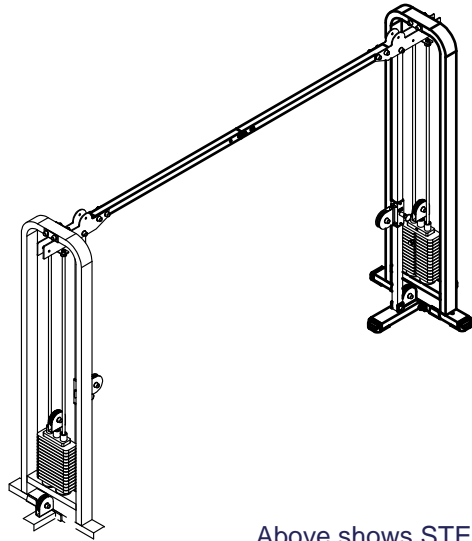

Above shows STEP 5 assembled and completed

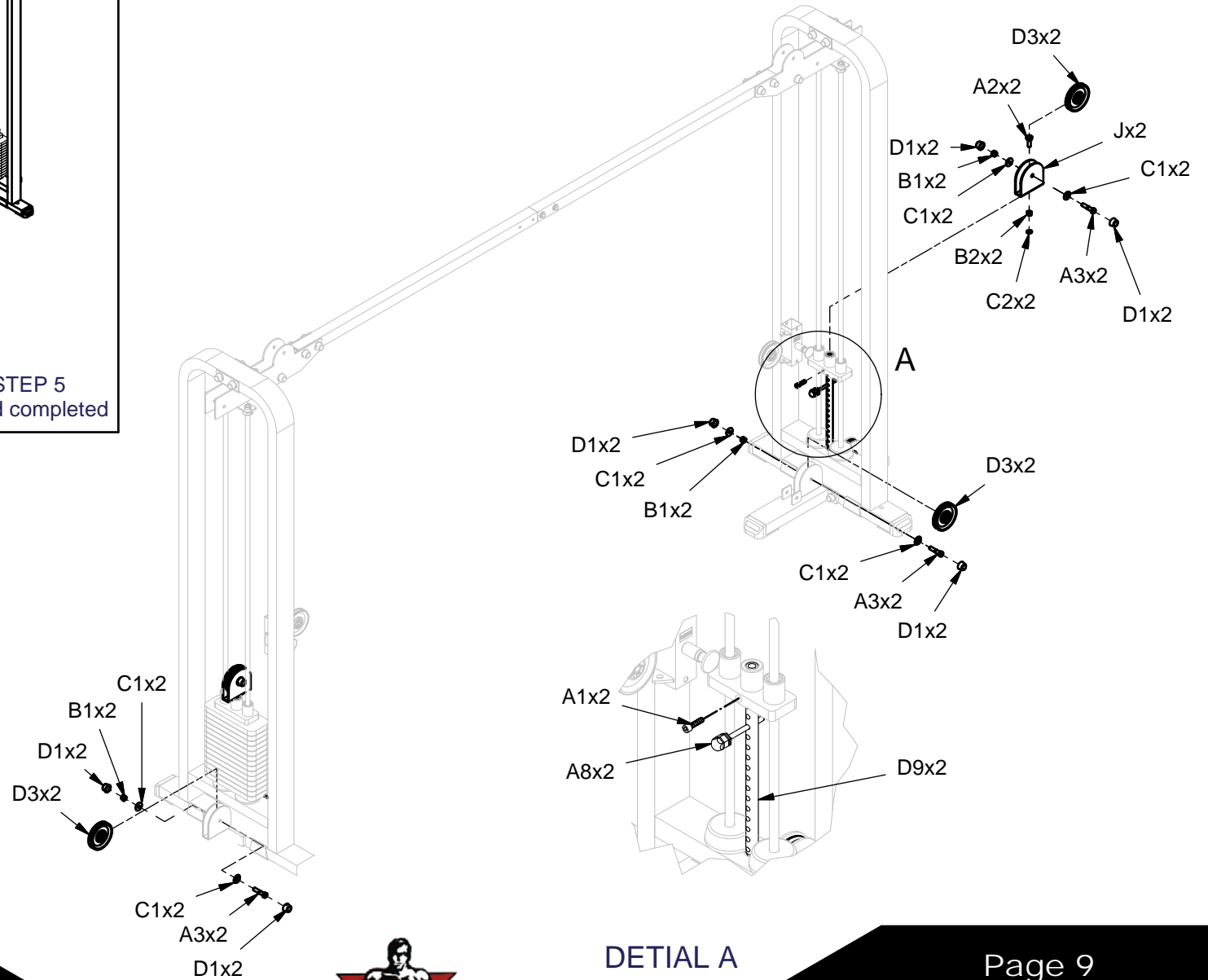



SCC-1200G ASSEMBLY INSTRUCTIONS

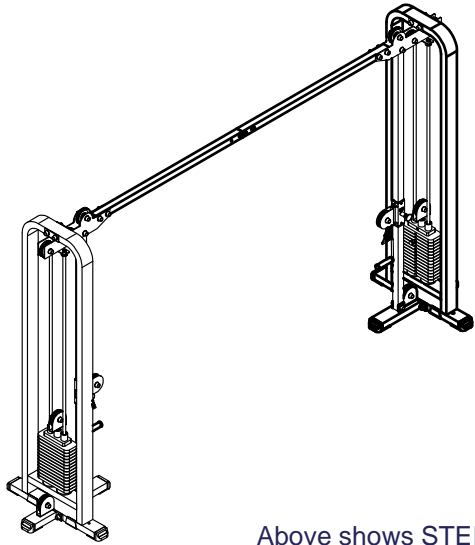

Above shows STEP 6 assembled and completed

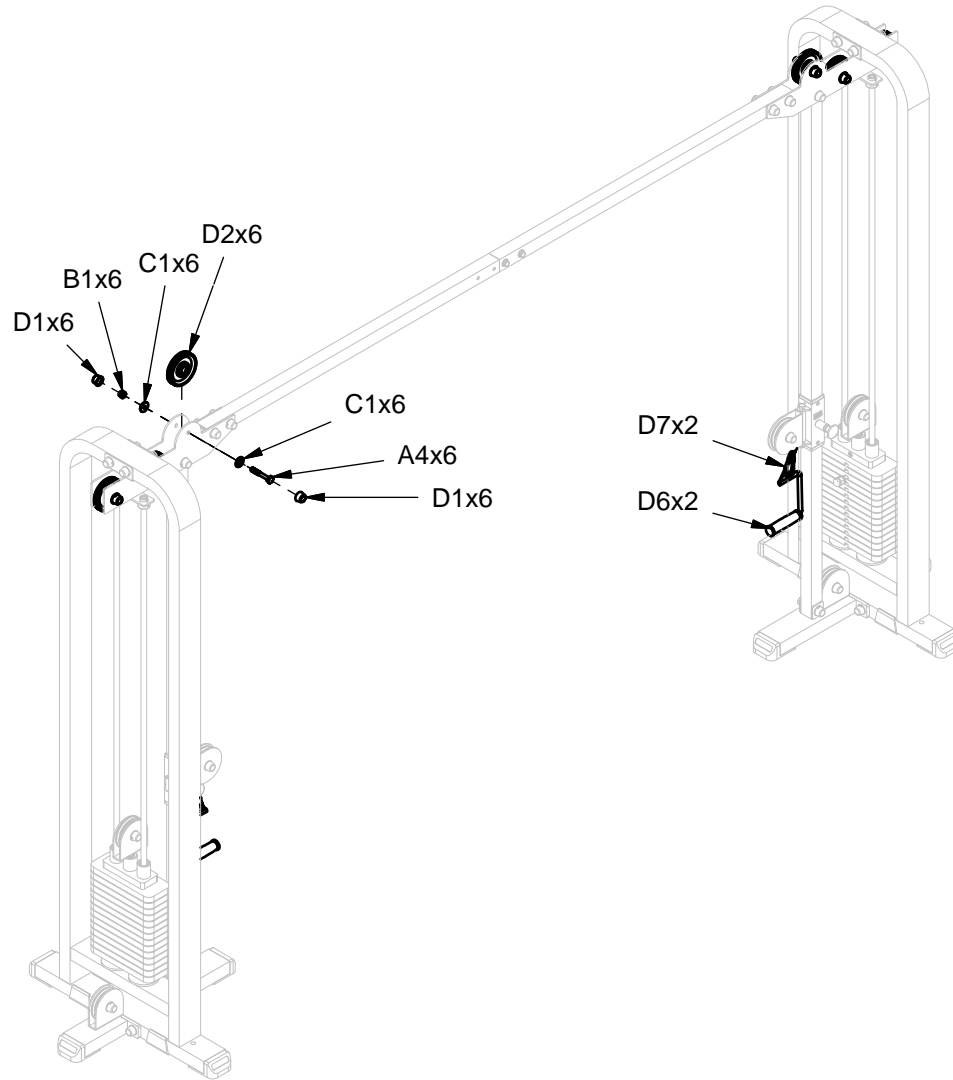



SCC-1200G ASSEMBLY INSTRUCTIONS

D11

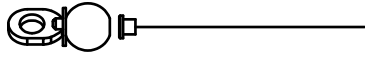

Cable to constitute illustration

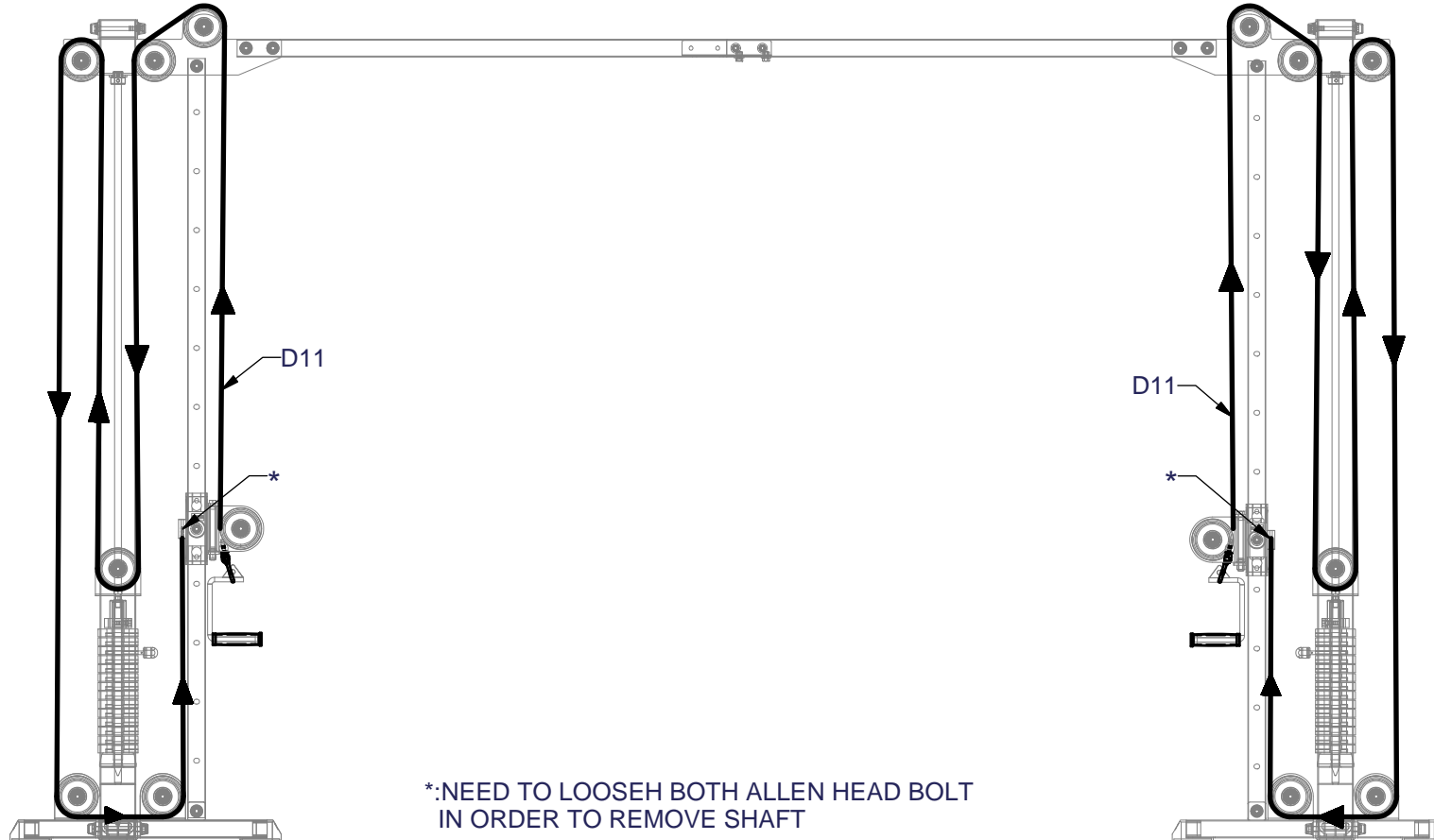

*:NEED TO LOOSEH BOTH ALLEN HEAD BOLT
IN ORDER TO REMOVE SHAFT





SCC-1200G ASSEMBLY INSTRUCTIONS

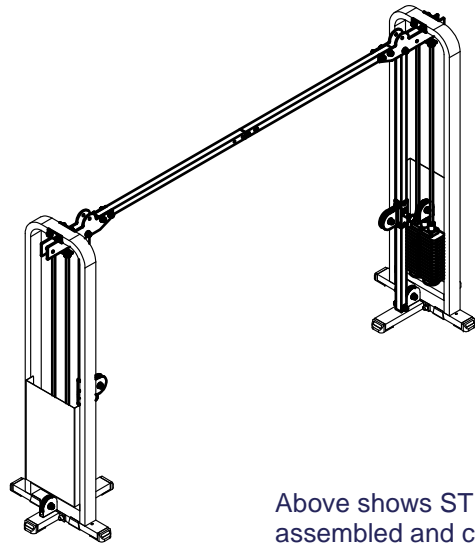

Above shows STEP 7
assembled and completed

