

USER MANUAL

MINI BOX HUB

Model No. HWG023WBRF



Welcome to the **RAINPOINT** family! Please read the manual before use to learn about the features and functions.

Contents

1. Box Contents	01
2. Introduction	02
2.1 Product Overview	02
2.2 Button and Light Introduction	02
2.3 Specification	03
3. Connection and Installation	04
3.1 Download app	04
3.2 Smart WiFi Connection	06
3.3 AP Connection	10
3.4 app Overview	13
4. Troubleshooting	17
5. Precautions	18
6. Warranty Policy	18
7. FCC Statement	19
8. Customer Support	20

1. Box Contents



1



2

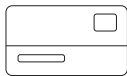

3

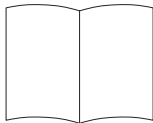

4

1. HWG023WBRF Mini Box Hub
2. USB Cable
3. Warranty Card
4. User Manual

2. Introduction

2.1 Product Overview

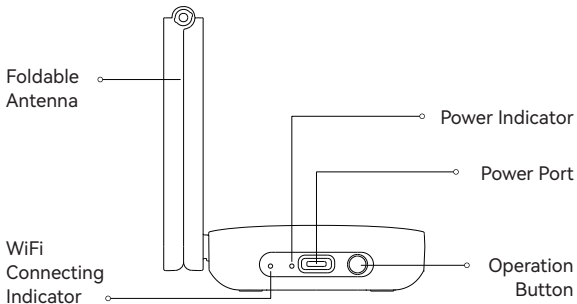

2.2 Button and Light Introduction

Operation Button

Press and hold the operation button for about 5 seconds to activate WiFi connection mode.

Indicator Meaning Table

Power Indicator Turn Solid Blue	Powered on
Connecting Indicator Blink Quickly	WiFi Connection Mode
Connecting Indicator Blink Slowly	AP Connection Mode
Connecting Indicator Turn Solid Blue	Connected with WiFi Successfully

2.3 Specification

- **Range Between WiFi Hub and Router:**
853ft (260m) in the open area without interference
- **Temperature Operating Range:** 3°C-40°C (37.4°F-104°F)
- **WiFi Frequency Band:** 2.4GHz Only
- **Input:** DC 5V 1A
- For Indoor Use Only

3. Connection and Installation

3.1 Download app

3.1.1 Download

- Search and download **RainPoint Home app** on App Store or Google Play:

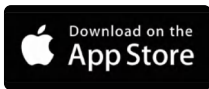

OR scan the QR code below to download the app



iOS



Android

b. **Create an account and log in:**

Follow in-app instructions to sign up for your account or log in with your existing account and start adding device.

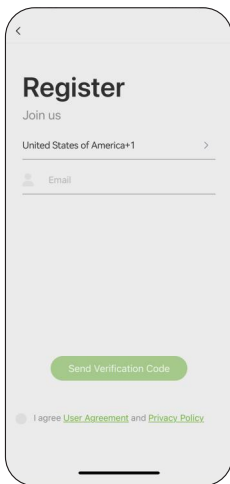
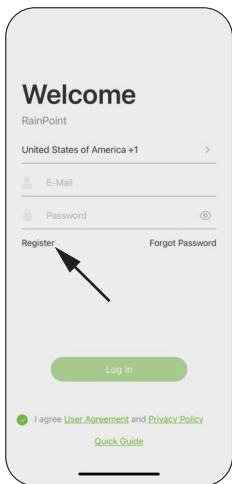

3.2 Smart WiFi Connection

3.2.1 Before Connection

To assure your **hub** connect to Wi-Fi, it will need to meet the following requirements:

- Please make sure your mobile device is connecting with **2.4GHz** Wi-Fi before using **RainPoint Home** app. The hub has to keep staying under **2.4GHz** Wi-Fi to work normally.
- **iOS Requirements:** Mobile device with iOS 11.0 (or higher) with cellular or Wi-Fi service.
- **Android Requirements:** Mobile device with Android OS 6.0 (or higher) with cellular or Wi-Fi service.
- Please do not use public Wi-Fi networks.
- The hub and your mobile device are better to be within 10 feet (3m) during pairing.
- If you need to change the working Wi-Fi network, press and hold the operation button on the hub to reset your hub and reconnect.

3.2.2 WiFi Connection

Plug in the hub near the router and follow the steps below to connect:

- a. Tap **+** or **"Add Device"** on the Home page, and select **HWG023WBRF**. Or press  scan QR code and move onto next step.

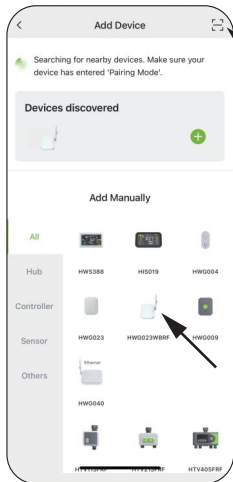
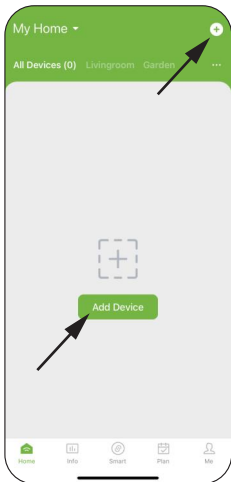

0210023002

- b. Log into Wi-Fi and tap **Next**.

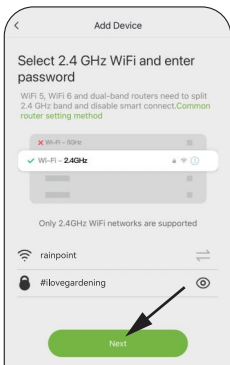

- c. Follow in-app instructions to complete the connection.

The indicator will flash blue rapidly when in WiFi connection mode and turn solid blue when connected successfully.

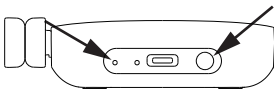

Press and hold the button for about 5 seconds to activate WiFi connection mode.

d. **Congratulations!**

Now the hub has been successfully connected with WiFi network and added on your app. You can add up to 39 devices controlled by this hub by click "**+ Add Device**" icon.

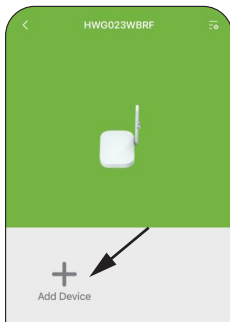

Tips: If failed to connect through the smart WiFi connection mode, please try AP connection mode or contact the customer support team.

Email: support@rainpointonline.com

3.3 AP (Access Point) Connection

- a. You can access to AP Connection Mode by click **"Switch Mode"** on Smart WiFi Connection page and follow in-app instructions.

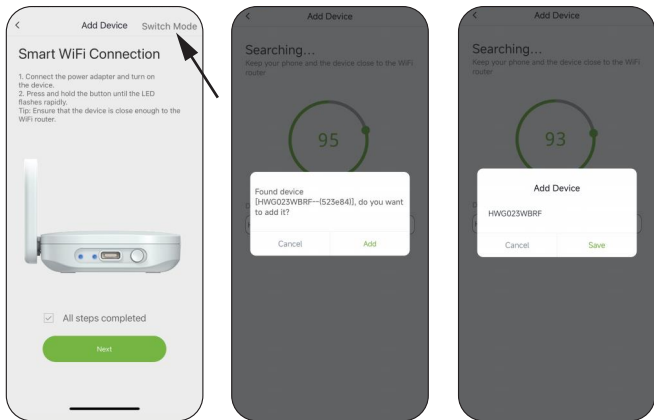

When Wifi connecting indicator flashes slowly, tick the checkbox on the app, click "Next", then follow the wizard and click "Go Connecting" to connect your phone to the hotspot (HomGar_xxxx or HG_xxxx).

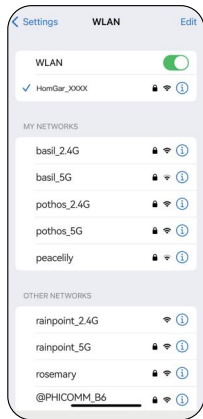
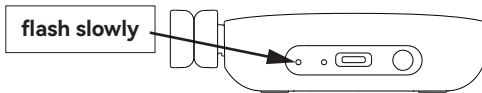

Note: If the mobile device pops up that there is no signal and needs to switch WiFi, please do not switch. Please keep the selected hotspot (**HomGar_xxxx** or **HG_xxxx**), to connect.

- Back to the app and click **"Next"** to continue adding devices automatically.

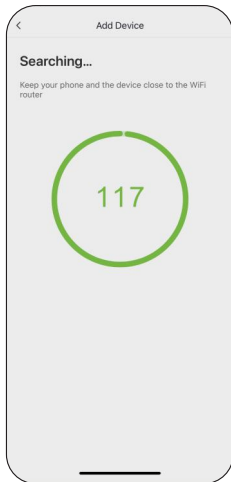
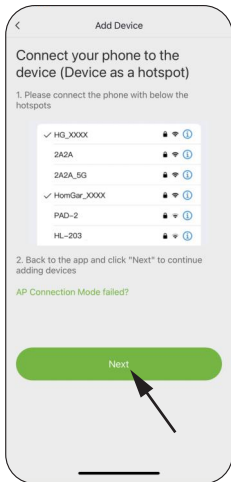

3.4 app Overview

3.4.1 app Home page

- **Home Management:** Set home name, location and other information to manage your home environment monitoring system more intelligent and accurate.
- **All Devices:** All added devices will be displayed here.
- **Room Management:** Related devices list of each room will be displayed here.
- **Add Devices:** To add devices under your monitor and management.
- **Home:** The app home page.
- **Plan Page:** List all of your irrigation plans that set on water timers/pumps. You can manually turn on or off the plan by the button on the right. There is also a manual Rain Delay button in each plan. It is available to check and edit the plans on the specific device plan page.
- **Info:** Check weather information and list of optional devices.
- **Me and Basic Settings:** Manage your account, home, basic settings, and other options. You can also find unit format and notification button in these settings.
- **Smart:** You can define various scenarios to manage the devices as per your desire.

Notes: After the hub and devices are connected, the list of the devices will be displayed on both app's home page and the hub's device page. You can click the device icons in the **"All Devices"** list to enter the device page, or find them on hub's device page.

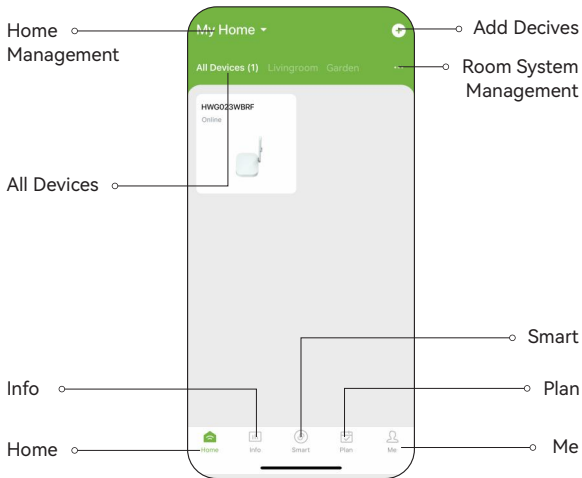

3.4.2 Device Page

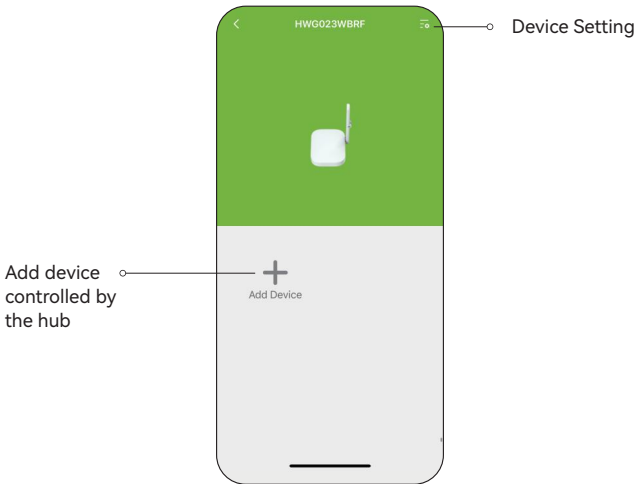

3.4.3 Device Settings

On device settings page, you can find basic information of the device and some default settings.



Tips: Timing setting **ONLY** works for precision clock product to calibrate time.

4. Troubleshooting

Problems	Solution
WiFi hub gets disconnected or offline.	<ul style="list-style-type: none">• Please check if the router works normally.• If there is a power shut down and then recover, and the router is back to work again, please reconnect the WiFi hub following the connection part of this manual.• Please check if the WiFi signal is unstable.• If the distance between the hub and the router is too far, please move the hub closer to make the connection more stable.
Devices get disconnected.	<ul style="list-style-type: none">• Please check the stability of Wi-Fi signal.• If there are any strong signal sources in between hub and devices, please move the devices to another place to avoid interference.
The operation button on the WiFi hub doesn't work.	Please contact our customer service for more support and suggestions.

5. Precautions

- Please make sure to use **2.4GHz** band WiFi to connect to this product.
- Do not block the vent, insert fingers, or any objects, as this may cause equipment failure or other conditions.
- Do not use the product near gas, heaters, microwave ovens, and other positions that may cause interference.

6. Warranty Policy

RainPoint provides a 1-year limited warranty on this product against manufacturing defects in materials and workmanship. You can get an extra two years of extended warranty by registering your product on our website www.rainpointonline.com



À DÉPOSER
EN MAGASIN
OU
À DÉPOSER
EN DÉCHÈTERIE

Points de collecte sur www.quefairemedesdechets.fr
Privilégiez la réparation ou le don de votre appareil !

7. FCC Statement (2AWDBHWG023)

This device complies with Part 15 of the FCC Rules. Operation is subject to the following two conditions:

1. This device may not cause harmful interference.
2. This device must accept any interference received, including interference that may cause undesired operation.

FCC Warning: Any changes or modifications not expressly approved by the party responsible for compliance could void the user's authority to operate this equipment.

Note: This equipment has been tested and found to comply with the limits for a Class B digital device, pursuant to Part 15 of the FCC Rules. These limits are designed to provide reasonable protection against harmful interference in a residential installation. This equipment generates, uses, and can radiate radio frequency energy, if not installed and used in accordance with the instructions, may cause harmful interference to radio communications. However, there is no guarantee that interference will not occur in a particular installation. If this equipment does cause harmful interference to radio or television reception, which can be determined by turning the equipment off and on, the user is encouraged to try to correct the interference by one of the following measures:

- Reorient or relocate the receiving antenna.
- Increase the separation between the equipment and the receiver.
- Connect the equipment into an outlet on a circuit different from that to which the receiver is connected.
- Consult the dealer or an experienced radio/TV technician for help.

Note: The manufacturer is not responsible for any radio or TV interference caused by unauthorized modifications to this equipment. Such modifications could void the user's authority to operate the equipment.

8. Customer Support



Please subscribe to our channel:
Rainpoint on YouTube for tutorial videos.

Or scan the QR code to visit RainPoint channel on
YouTube.

Need Help ?

Scan the QR code for more help.



or Email:

support@rainpointonline.com

