

# Operating instructions

Combair SE | SEP

Oven

Thank you for choosing to buy one of our products. Your appliance is made to high standards and is easy to use. Nevertheless, please take the time to read these operating instructions in order to familiarize yourself with the appliance and get the best use out of it.

**Please follow the safety precautions.**

**Modifications**

Text, diagrams and data correspond to the technical standard of the appliance at the time these operating instructions went to press. The right to make technical modifications for the purpose of the further development of the appliances is reserved.

**Validity**

The model number corresponds to the first alphanumeric on the identification plate. These operating instructions apply to:

<b>Model designation</b>	<b>Model number</b>	<b>Type</b>	<b>Size system</b>
Comhair SE 60	21016	BCSEZ60c	60-600
Comhair SE 60	21016	BCSEZ60g	60-600
Comhair SEP 60	21019	BCSEPZ60c	60-600
Comhair SEP 60	21019	BCSEPZ60g	60-600
Comhair SEP 60	21060	BCSEPZ60c	60-600

Variations depending on the model are noted in the text.

Colour operating instructions can be downloaded from the internet from [www.vzug.com](http://www.vzug.com).



# Table of contents

<b>1</b>	<b>Safety precautions</b>	<b>5</b>	6.1	Recipe book.....	22
1.1	Symbols used.....	5	6.2	Own recipes.....	23
1.2	General safety precautions.....	5	6.3	Soft roasting.....	26
1.3	Appliance-specific safety precautions .....	5	6.4	Keep warm *.....	28
1.4	Instructions for use.....	6	<b>7</b>	<b>EasyCook</b>	<b>28</b>
<b>2</b>	<b>Using for the first time</b>	<b>9</b>	7.1	Overview of food groups.....	28
<b>3</b>	<b>Appliance description</b>	<b>10</b>	7.2	Selecting and starting foods.....	28
3.1	Construction .....	10	<b>8</b>	<b>Favourites</b>	<b>29</b>
3.2	Operating and display elements.....	10	8.1	Creating favourites .....	29
3.3	Cooking space.....	11	8.2	Selecting and starting favourites .....	29
3.4	Accessories .....	12	8.3	Changing favourites .....	29
3.5	Plate warmer.....	12	8.4	Deleting favourites.....	29
<b>4</b>	<b>Operating modes</b>	<b>13</b>	<b>9</b>	<b>Tips and tricks</b>	<b>30</b>
4.1	Overview of operating modes.....	13	9.1	Unsatisfactory cooking result.....	30
4.2	Top/Bottom heat.....	13	9.2	Saving energy.....	30
4.3	Hot air .....	13	<b>10</b>	<b>User settings</b>	<b>31</b>
4.4	PizzaPlus .....	14	10.1	Overview of user settings.....	31
4.5	Grill .....	14	10.2	Adjusting user settings .....	31
4.6	Grill-forced convection.....	14	10.3	Language .....	31
4.7	Top/Bottom heat humid .....	15	10.4	Display .....	31
4.8	Hot air humid.....	15	10.5	Date.....	32
4.9	Bottom heat .....	15	10.6	Clock .....	32
4.10	Fast heating.....	16	10.7	Notifications .....	32
<b>5</b>	<b>Using the appliance</b>	<b>16</b>	10.8	Pyrolytic cleaning of appliance .....	33
5.1	Selecting and starting the operating mode....	16	10.9	Loudness.....	33
5.2	Checking and changing the settings.....	17	10.10	Assistance functions .....	33
5.3	Setting a duration .....	17	10.11	Temperature .....	33
5.4	Setting a delayed start / end time.....	18	10.12	Childproof lock.....	34
5.5	Food probe temperature .....	18	10.13	Appliance information.....	34
5.6	Cancelling/ending the operating mode before time.....	19	10.14	Demo mode.....	34
5.7	Changing the operating mode .....	20	10.15	Factory settings.....	34
5.8	Timer .....	20	<b>11</b>	<b>Care and maintenance</b>	<b>34</b>
5.9	End of operation .....	21	11.1	Cleaning the exterior.....	34
5.10	Switching the appliance off.....	21	11.2	Cleaning the cooking space.....	34
<b>6</b>	<b>GourmetGuide</b>	<b>22</b>	11.3	Cleaning the appliance door.....	35
			11.4	Cleaning the door seal .....	35

---

11.5	Replacing the door seal.....	36
11.6	Replacing the door seal on pyrolysis appliances 36	
11.7	Replacing the halogen light bulb .....	37
11.8	Cleaning the accessories and shelf guides ...	38
11.9	Pyrolytic self-cleaning .....	38
<b>12</b>	<b>Trouble-shooting</b>	<b>40</b>
12.1	What to do if .....	40
12.2	After a power failure.....	42
<b>13</b>	<b>Accessories and spare parts</b>	<b>43</b>
13.1	Accessories .....	43
13.2	Special accessories .....	44
13.3	Spare parts .....	44
<b>14</b>	<b>Technical data</b>	<b>44</b>
14.1	Note for testing institutes .....	44
14.2	Temperature measurement .....	45
14.3	Product fiche .....	45
14.4	EcoStandby.....	45
14.5	Reference to «Open Source» licence.....	45
<b>15</b>	<b>Disposal</b>	<b>46</b>
<b>16</b>	<b>Index</b>	<b>47</b>
<b>17</b>	<b>Notes</b>	<b>49</b>
<b>18</b>	<b>Service &amp; Support</b>	<b>51</b>

# 1 Safety precautions

## 1.1 Symbols used



Denotes important safety precautions.

**Failure to observe said precautions can result in injury or in damage to the appliance or fittings!**



Information and precautions that should be observed.



Information on disposal



Information about the Operating Instructions

- ▶ Indicates step-by-step instructions.
  - Describes how the appliance reacts to the steps taken.
- Indicates a list.

## 1.2 General safety precautions



- Read the operating instructions before using the appliance for the first time!



- This appliance can be used by children aged 8 and above and by persons with reduced physical, sensory or mental capabilities, or lack of experience and/or knowledge, provided they are supervised or have been instructed on the safe use of the appliance and have understood the hazards involved. Children shall not play with the appliance.

Cleaning and user maintenance shall not be undertaken by children without supervision.

- If an appliance is not equipped with a mains cable and a plug or other means for disconnecting from the mains with a contact opening on each pole complying with the conditions of overvoltage category III for full isolation, an isolating device must be incorporated into the permanently installed electrical installation in accordance with the installation regulations.
- If the mains cable of this appliance is damaged, it must be replaced by the manufacturer or its Customer Services or a similarly qualified person in order to avoid hazard.

## 1.3 Appliance-specific safety precautions



- **READ THE IMPORTANT SAFETY PRECAUTIONS CAREFULLY AND RETAIN FOR FUTURE USE.**
- **WARNING:** The appliance and its accessible parts get hot during use. Be careful not

- to touch the heating elements. Children under 8 years of age must be kept away from the appliance unless they are constantly supervised.
- **WARNING:** Accessible parts can get hot during use. Keep young children away from the appliance.
  - This appliance is intended for use in the home and similar settings such as: in staff kitchens in shops, offices and other commercial establishments; in agricultural establishments; by guests in hotels, motels and other accommodation establishments; in bed and breakfast establishments.
  - A heatable appliance drawer and its contents get hot.
  - Only use the food probe recommended for this oven.
  - Under no circumstances use a steam cleaner to clean the appliance.
  - **WARNING:** Before replacing the light bulb, ensure the appliance is switched off and disconnected from the mains power supply to avoid possible electric shock.
  - To avoid overheating, the appliance must not be installed behind a decor door.
  - This appliance is not intended for use in vehicles or on board ships or aircraft or in rooms where there are special conditions such as, for instance, a corrosive or explosive atmosphere (dust, steam or gas) or condensing moisture.
  - **WARNING:** Never heat food or liquids in sealed containers such as cans or bottles as they are liable to explode due to overpressure.
  - See the «Accessories» section for the proper use of insertable parts.

### 1.4 Instructions for use

#### Before using for the first time

- The appliance must be installed and connected to the electricity supply in accordance with the separate installation instructions. Have a qualified fitter/ electrician carry out the necessary work.

#### Correct use

- The appliance is designed for use in the home for preparing food. Under no circumstances flambé or cook food using a lot of fat in the cooking space! No liability is assumed for any damage caused by improper use or incorrect handling.
- Never use the appliance to dry animals, textiles or paper, etc.
- Do not use the appliance as a room heater.
- The appliance should only be installed and operated at an ambient temperature of 5 °C to 35 °C.

- Any repairs, modifications or manipulations to the appliance, especially any electrically live parts, may only be carried out by the manufacturer, its Customer Services or a similarly qualified person. Repairs if carried out incorrectly may cause serious injury, damage to the appliance and fittings, as well as affect the functioning of the appliance. If the appliance is not working properly or in case of a repair order, follow the instructions given in the «Service & Support» section. Please contact our Customer Services if necessary.
- Use original spare parts only.
- Retain these operating instructions for future reference.
- The appliance corresponds to recognized technology standards and the relevant safety regulations. Proper use of the appliance is essential to avoid damage and accidents. Please therefore follow the precautions given in these operating instructions.

#### Note on use

- Use the childproof locking facility.
- If the appliance is visibly damaged, do not use it. Contact our Customer Services.
- If the appliance is not operating properly, disconnect it from the power supply immediately.
- Ensure there are no foreign bodies or pets in the cooking space before closing the appliance door.
- Objects that could pose a danger if the appliance were accidentally switched on should not be stored in the cooking space or the heatable appliance drawer. Do not store food or any temperature-sensitive or inflammable materials, e.g. cleaning agents, oven sprays, etc., in the cooking space or the heatable appliance drawer.
- For appliances with grill: Leave the appliance door closed when grilling. The heat could otherwise damage the operating and display elements or the fitted units above.

#### Caution: Risk of burns!

- The appliance gets very hot when in use. The appliance door also gets hot.
- Steam and/or hot air may escape from the cooking space when the appliance door is opened.
- The appliance will remain hot for some time after it is switched off and will only cool down slowly to room temperature. Allow sufficient time for the appliance to cool down before, for instance, cleaning it.
- Overheated fat and oil can easily catch fire. Heating oil in the cooking space to sear meat is dangerous and should not be done. Never attempt to extinguish burning oil or fat with water. Danger of explosion! Smother the flames with a fire blanket. Keep doors and windows closed.
- Do not pour spirits (brandy, whisky, schnapps, etc.) over hot food. Danger of explosion!
- Do not leave the appliance unattended when drying herbs, bread, mushrooms, etc. If the foodstuff dries out too much, it can pose a fire hazard.
- If you notice smoke possibly coming from the appliance itself or from inside the cooking space, keep the appliance door closed. Disconnect the appliance from the power supply.
- Accessories get hot in the cooking space. Use protective gloves or oven cloths.

#### Caution: Risk of injury!

- Be careful not to put fingers in the door hinges as there is otherwise a risk of injury if the appliance door is moved. Particular care should be taken when children are around.
- For cookers: A hob guard can be fitted to protect small children. Hob guards are available from specialist retailers.

### **Caution: Risk to life!**

- Danger of suffocation! Keep packaging material, e.g. plastic film and polystyrene, away from children. Packaging material can be dangerous for children.

### **How to avoid damaging the appliance**

- Close the appliance door carefully.
- For appliances with visible bottom heating element: Do not place any objects directly on the bottom heating element.
- Do not use protective aluminium inserts with appliances with no visible bottom heating element.
- Do not use objects that can rust in the cooking space.
- Using knives or cutting wheels on the baking tray will visibly damage the surface.
- To prevent corrosion, leave the appliance door open in the at-rest position until the cooking space has cooled down.
- When cleaning the appliance, make sure no water gets inside it. Use a moderately damp cloth. Do not spray the outside or the inside of the appliance with water. If water gets inside the appliance, it will cause damage.

## 2 Using for the first time

Before operating the newly installed appliance for the first time, the following steps should be taken:

- ▶ Remove packaging and transport materials as well as any protective blue film from out of the cooking space.
- ▶ Clean the cooking space and the accessories.
- ▶ Press the power button.
  - The appliance switches on.

### Version 1 \*

\* Depending on the software version

- Various user settings necessary for operation, such as language, time and temperature unit, appear in the display one after the other.
- ▶ Make the settings and confirm.



Language and time must be set so that the appliance can be operated.

### Version 2 \*

\* Depending on the software version

- ▶ Set the time (see page 32).

### Completing the initial set-up

- ▶ Heat the empty cooking space (without wire shelves, baking trays, etc.) using the  operating mode at 230 °C for about 30 minutes.



As there is likely to be some smoke and odour given off, we recommend ventilating the room well during this phase.



All temperatures in these operating instructions are in degrees Celsius. Apply the corresponding conversions via the user setting «Degrees Fahrenheit» (see page 33).

### 3 Appliance description

#### 3.1 Construction

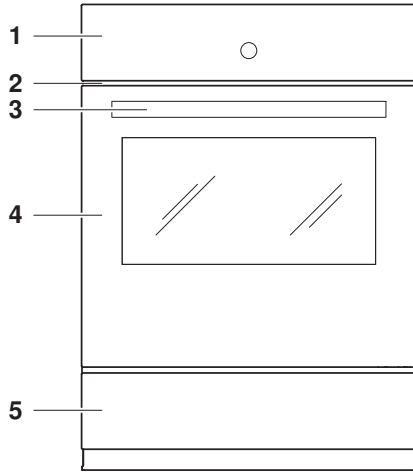

- 1 Operating and display elements
  - 2 Ventilation opening
  - 3 Door handle
  - 4 Appliance door
  - 5 Heatable appliance drawer \*
- \* Depending on model



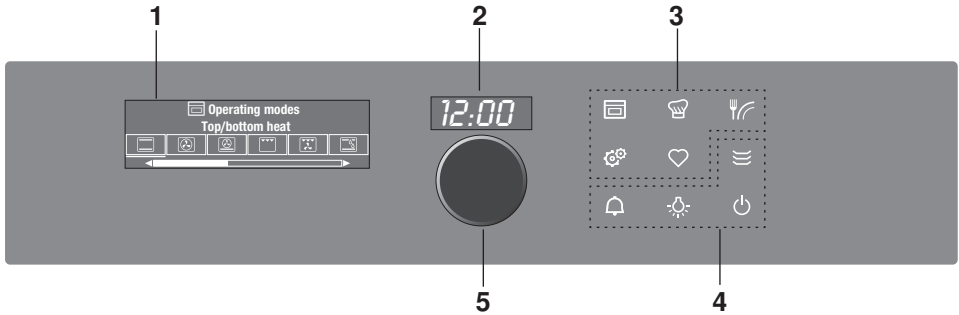





#### 3.2 Operating and display elements



- 1 Display
- 2 Digital display (duration/timer/time)
- 3 Menu buttons
- 4 Action buttons
- 5 Adjusting knob / switching on appliance

## Overview of touch buttons



-  Operating modes
  -  GourmetGuide
  -  EasyCook
  -  User settings
  -  Favourites
  -  Heatable appliance drawer / plate warmer \*
- \* Depending on model
-  Timer
  -  Cooking space illumination
  -  Switch off

## 3.3 Cooking space



**Using protective inserts or aluminium foil can damage the appliance.**

Do not place any protective insert or aluminium foil on the floor of the cooking space.

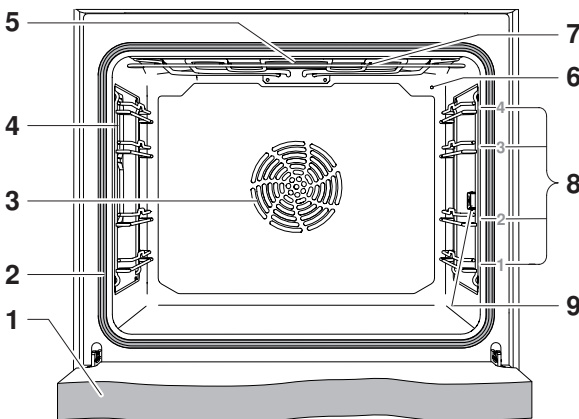

- |   |                            |   |                       |
|---|----------------------------|---|-----------------------|
| 1 | Appliance door             | 6 | Temperature sensor    |
| 2 | Door seal                  | 7 | Grill/top heat        |
| 3 | Hot air blower             | 8 | Levels (labelled)     |
| 4 | Cooking space illumination | 9 | Socket for food probe |
| 5 | Cooking space ventilation  |   |                       |



The bottom heating element is beneath the cooking space floor.

### 3.4 Accessories



**Incorrect handling can cause damage!**

**Do not use knives or cutting wheels on the accessories.**

**Observe the correct use of the grill and oven furniture!**

#### TopClean baking tray



- Baking tin for flans and biscuits
- Use together with the wire shelf as a drip tray
- If not fully covered, its shape can become distorted during baking. This is normal. It will go back to its original form as it cools down.

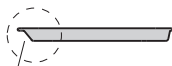

- ▶ Ensure that the «sloped» side **1** of the baking tray is to the back of the cooking space.

**1**

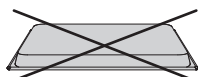

- ▶ Only use the normal way round – not upside down.

#### Wire shelf

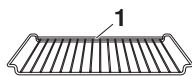

- For standing roasting and baking tins on
- For standing meat, frozen pizza, etc. on
- ▶ Ensure that the bar **1** is to the back of the cooking space. This enables the food to be removed safely from the cooking space.

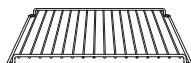

- Outside the cooking space – inverted – serves as a cooling rack.

#### Food probe



- For measuring the core temperature of food



For recommended food probe temperatures, see «EasyCook».



Not suitable for temperatures of over 230 °C. There must be a distance between the food probe and the roof of the cooking space of at least 5 cm.

#### Special accessories



**Place any accessories not included in the scope of delivery on the wire shelf.**

- ▶ Special accessories can be found at: [www.vzug.com](http://www.vzug.com)

### 3.5 Plate warmer

- ▶ If the appliance is switched off, first press the adjusting knob.
- ▶ Put the wire shelf at level 1 and place the tableware on it.
- ▶ Press the  touch button.
- ▶ Set the required duration.



Select a duration of at least 1 hour.

- ▶ Set the end time if necessary.
- ▶ Switch on the «Plate warmer» by selecting ▶.
  - The «Plate warmer» switches off automatically when the set duration is over.

## 4 Operating modes

### 4.1 Overview of operating modes

All the operating modes and fast heating are described below.



Follow the advice given in «Tips and tricks» (see page 30) and in «EasyCook».

### 4.2 Top/Bottom heat



Temperature range	30–280 °C
Temperature range for pyrolysis appliance	30–300 °C
Recommended value	200 °C
Level	2 (or 1)

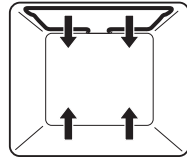

The cooking space is heated by the top and bottom heating elements.

#### Uses

- Classic operating mode for cooking and baking on one level
- Cakes, biscuits, bread and roasts



Use a dark enamelled tray or a black tray or tin for crispy results.

### 4.3 Hot air



Temperature range	30–250 °C
Temperature range for pyrolysis appliance	30–280 °C
Recommended value	180 °C
Level	1 + 3 or 2 (or 1 + 3 + 2)



A heating element behind the back wall of the cooking space heats up the air inside the cooking space, which is circulated evenly.

#### Uses

- Particularly suitable for baking savouries and biscuits on several levels at the same time
- Cakes, bread and roasts



Select a lower temperature (reduce by approximately 20 °C) than for  as the heat transfer is more efficient.

## 4.4 PizzaPlus



Temperature range	30–250 °C
Recommended value	200 °C
Level	2 (or 1)

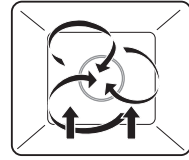

The cooking space is heated by hot air and bottom heat. The base of the food is baked particularly intensively.

### Uses

- Pizza
- Flans and quiches



Use a dark enamelled tray or a black tray or tin without baking paper for very crispy results.

## 4.5 Grill



Temperature range	5 levels
Recommended value	Level 3
Level	3 or 4

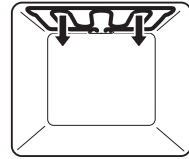

The cooking space is heated by the grill element.

### Uses

- Flat food for grilling, e.g. steaks, chops, chicken parts, fish and sausages
- Gratinating
- Toast
- ▶ Place the food to be grilled directly on the wire shelf.
- ▶ Line the baking tray with aluminium foil and then place it underneath the wire shelf.



For best results, preheat the cooking space for 3 minutes before introducing the food.

## 4.6 Grill-forced convection



Temperature range	30–250 °C
Recommended value	200 °C
Level	2 or 3

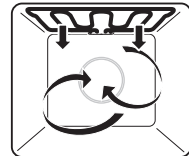

The cooking space is heated by the grill element. The hot air fan distributes the air evenly in the cooking space.

### Uses

- Suitable for a whole chicken
- Large, bulky food for grilling

- ▶ Put food for grilling in a porcelain or glass dish or directly on the wire shelf.
- ▶ Line the baking tray with aluminium foil and then place it underneath the wire shelf.

#### 4.7 Top/Bottom heat humid



Temperature range	30–250 °C
Recommended value	200 °C
Level	2 (or 1)

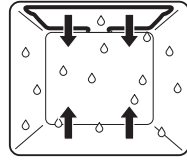

The cooking space is heated by the top and bottom heating elements. The steam produced is largely retained in the cooking space. The food retains its moisture.

##### Uses

- Bread, plaited bread, roasts and gratins on one level
- Low temperature cooking

#### 4.8 Hot air humid



Temperature range	30–250 °C
Recommended value	180 °C
Level	1 + 3 or 2 (or 1 + 3 + 2)

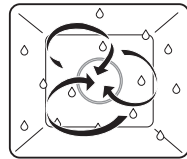

A heating element behind the back wall of the cooking space heats up the air inside the cooking space, which is circulated evenly. The steam produced is largely retained in the cooking space. The food retains its moisture.

##### Uses

- For savouries and biscuits on two levels at the same time
- For yeast pastries and bread on two levels at the same time
- Gratins and baked dishes



Select a lower temperature (reduce by approximately 20 °C) than for  as the heat transfer is more efficient.

#### 4.9 Bottom heat



Temperature range	6 levels
Recommended value	Level 3
Level	2 (or 1)

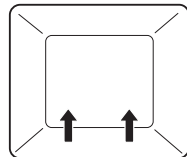

The cooking space is heated by the bottom heating element.



##### Uses





- Baking flan bases
- Making preserves



Use a dark enamelled tray or a black tray or tin for crispy results.

## 4.10 Fast heating

For fast heating , the cooking space is heated using hot air and bottom heat, which shortens the preheating time. Fast heating can be used with the following operating modes:  and .

- ▶ Select the desired operating mode and adjust the settings.
- ▶ To start the operating mode, select .
- ▶ Select  «Switch fast heating on» in the settings for the operating mode.
  - Above , the  symbol illuminates.

As soon as an acoustic signal is emitted:

- put the food into the cooking space.







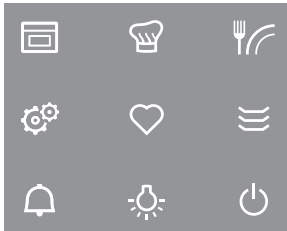

## 5 Using the appliance

The different main menus and functions are selected by pressing the corresponding touch button. Selected touch buttons and functions are illuminated in white; other selectable functions are illuminated in orange.

Settings and functions that cannot be selected or changed are greyed out in the various menus.

The following touch buttons with the following main menus and functions are available:



-  Operating modes
-  GourmetGuide
-  EasyCook
-  User settings
-  Favourites
-  Heatable appliance drawer / plate warmer \*
- \* Depending on model
-  Timer
-  Cooking space illumination
-  Switch off

### Adjusting knob functions

- |       |  |
|-------|--|
| Press | <ul style="list-style-type: none"> <li>▪ Switching on the appliance</li> <li>▪ Selecting/opening a submenu, setting, etc.</li> <li>▪ Confirming/closing a message</li> <li>▪ Activating/deactivating a user setting</li> </ul> |
| Turn  | <ul style="list-style-type: none"> <li>▪ Navigating within the submenus</li> <li>▪ Changing/setting a value, user setting</li> </ul>   |

### 5.1 Selecting and starting the operating mode

- ▶ If the appliance is switched off: first press the adjusting knob.
- ▶ If the appliance is in another menu: press the  touch button.
  - The selection of operating modes appears in the display.

- ▶ Select the operating mode.
  - The operating mode settings appear in the display; a recommended value appears above the temperature.
- ▶ Set the values for duration, end time, temperature or temperature level and target temperature as required and confirm.

### Press and go

Once all the necessary settings for the operating mode have been made, a bar appears in the display and counts down 20 seconds. If no further settings are made during this time, operation starts automatically. If a setting is changed, Press and go starts again.



The duration of Press and go can be adjusted (see page 33) or it can be deactivated in the user settings.

- ▶ To start operation immediately, i.e. without Press and go, select ▶.
  - If set, the countdown to the time remaining appears in the display and in the digital display.



The operating mode selected cannot be changed once it has started.

### Display overview

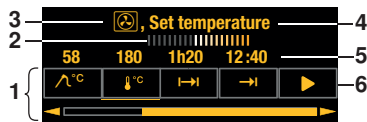

- 1 Operating mode settings
- 2 Press and go
- 3 Operating mode with symbol
- 4 Current position of the adjusting knob / selected setting
- 5 Set values / recommended values
- 6 Symbols for settings

## 5.2 Checking and changing the settings

- ▶ Select the symbol for the desired setting.
- ▶ To change the value, turn the adjusting knob to the right or left.
- ▶ Press the adjusting knob to confirm the setting.
  - The operating mode settings are displayed.
  - The changed value can be seen above the corresponding symbol.



The end time can only be changed during the first 60 seconds of operation.

## 5.3 Setting a duration

The operating mode selected ends automatically when the operating time is up.

- ▶ Select the desired operating mode.
- ▶ Select I-| in the operating mode settings.
- ▶ Set the desired duration – max. 9 hours and 59 minutes – and confirm.
  - The duration is displayed in the operating mode settings as well as the end time which is calculated based on this value.
  - End of operation / duration finished (see page 21)

## 5.4 Setting a delayed start / end time

The delayed start is activated when for the operating mode selected both the duration and the end time are set.

The appliance switches automatically on and off again at the desired times.

If you use the food probe, you will need to estimate and set the duration. You will find a guide on times in «EasyCook». The appliance switches on with a delay and switches off again when the set target temperature is reached. Depending on the estimated duration, this can occur earlier or later than the set end time.



Perishables should not be kept unrefrigerated.

### Before setting the delayed start

- ▶ Place the food in the cooking space.
- ▶ Select the desired operating mode.
- ▶ Set the temperature.
- ▶ Set the duration.

### Setting a delayed start

- ▶ Select →I in the operating mode settings.
  - The current end time calculated using the duration is displayed.
- ▶ Set the desired end and confirm.
  - The time remaining to the start of operation is displayed.
  - After 3 minutes, the display goes out and the  touch button is illuminated in white. The display can be called up again at any time by pressing the adjusting knob.
  - The appliance remains switched off until 3 minutes before the automatic start of operation.
- ▶ Check and change the settings (see page 17).

### Example

- ▶ Select the  operating mode and 180°C.
- ▶ At 8:00, set a duration of 1 hour and 15 minutes.
- ▶ Set the end time to 11:30.
  - The appliance will automatically switch on at 10:15 and off again at 11:30.

## 5.5 Food probe temperature



**Only use the supplied food probe.**

**Do not clean the food probe in the dishwasher. Always keep the plug clean.**

The food probe is used to measure the temperature inside the food (referred to as the **food probe temperature**). As soon as the food reaches the **target temperature** (the food probe temperature that should be attained at the end of the cooking process), operation stops automatically. It is also possible to simply measure the food probe temperature without stopping operation.



The food probe must be inserted as far into the middle of the meat as possible to get a correct reading of the food probe temperature.  
The optimal target temperature is dependent on the cut of meat and on the degree of doneness.  
Refer to the information on target temperatures in «EasyCook».

## Setting

- ▶ Select the desired operating mode and set the temperature.
- ▶ Select  $\wedge^{\circ}\text{C}$  in the operating mode settings.
- ▶ Set the desired target temperature and confirm.
- ▶ To start operation, select ▶.



Operation can only be started when the food probe is plugged in.

- ▶ Check and change the settings (see page 17).
  - The current food probe temperature is shown in the top part of the display when cooking.
  - The set target temperature is displayed above  $\wedge^{\circ}\text{C}$ .
  - Operation ends automatically once the target temperature has been reached – see also End of operation (see page 21).



If the meat is left in the cooking space after having switched off the appliance, the food probe temperature will continue to rise due to the residual heat.

## Measuring the food probe temperature

If you only wish to measure the food probe temperature without operation stopping automatically when the target temperature is reached, proceed as follows:

- ▶ Select the desired operating mode and set the temperature and, if you wish, the duration.
- ▶ Plug in the food probe.
- ▶ Start the operating mode.
  - The current food probe temperature is shown in the top part of the display when cooking.

## 5.6 Cancelling/ending the operating mode before time

- ▶ In the operating mode settings, select ■ or press the  $\text{⏏}$  touch button.
  - An acoustic signal is emitted.
  - The selected operating mode is cancelled.
  - The following appears in the display: « $\triangle$  Residual heat» and, for example: « $\text{⏏}$  Hot air cancelled».
  - If the food probe is plugged in, the food probe temperature is displayed. \*

\* Depending on the software version



- ▶ If you wish to start a new operating mode, press the  $\text{⏏}$  touch button.
- ▶ If you wish to switch off the appliance, press the  $\text{⏏}$  touch button.

## 5.7 Changing the operating mode

If no operating mode is running:

- ▶ Select  in the settings of the current operating mode.
  - The operating modes menu is displayed.

If an operating mode is already running:

- ▶ Select  or press the  touch button.
  - The set operating mode is cancelled.
- ▶ Press the  touch button and select a new operating mode.

## 5.8 Timer

The timer functions like an egg timer. It can be used at any time and independently of all other functions.

### Setting and starting the timer

- ▶ Press the  touch button.
  - A suggested value of «10min» appears in the display.
- ▶ Turn the adjusting knob and set the desired duration.
  - The duration and the end time for the timer appear in the display.

The timer can be set for:

- up to 10 minutes in 10-second intervals, e.g. = 9 minutes and 50 seconds;
- over 10 minutes in 1-minute intervals, e.g. = 1 hour and 12 minutes;
- over 10 hours in 1-hour intervals, e.g. = 18 hours.

The maximum timer duration is 99 hours.

- ▶ Press the adjusting knob to confirm.
  - The timer starts.
  - If there is no operating mode running with a set duration, the remaining time on the timer will be displayed in the digital display.
  - The  touch button is illuminated in white.
  - If the appliance was in another menu before the timer was set, e.g. operating modes: the menu or the submenu selected within it, e.g. a running operating mode, appears.
  - If the appliance was not in another menu: the display goes black.

### Checking and changing

- ▶ Press the  touch button.
  - The countdown to the time remaining appears in the display.
- ▶ Shorten or extend the time by turning the adjusting knob.
- ▶ Confirm this shortening or extending of the time.

### When the timer finishes

When the set duration is up:

- An acoustic signal is emitted.
- «Timer finished» appears in the display.
- ▶ To close the message, select .

### Switching the timer off before time

- ▶ Press the  touch button.
  - The countdown to the time remaining appears in the display.
- ▶ Set the timer to 0 by turning the adjusting knob and confirm.

Or, if the timer is the only active function:



- ▶ Press the  touch button.

Or, to switch off the appliance:

- ▶ Press the  touch button 2x.

## 5.9 End of operation

When the set duration is up or, if the food probe is being used, when the set target temperature is reached:

- The selected operating mode ends automatically.
- An acoustic signal is emitted.
- Three options are displayed:
- Select  to choose a new operating mode
- Select : to extend the operation
- Select  to switch the appliance off.
  - The appliance switches off automatically after 3 minutes without interaction.



You can adjust the appliance end time individually (see page 32).

- As long as the temperature is above 80 °C, « Residual heat» appears in the display.
- If the food probe is plugged in, the food probe temperature is displayed. \*



The food can be kept warm with residual heat for some time. As soon as the temperature falls below 80 °C, all the displays go out. If at this point the food probe is still plugged in, the displays only go out when the food probe is unplugged. \*  
The cooling fan can continue to run.

\* Depending on the software version

## Removing food from cooking space





### Risk of burns!

Hot air may escape from the cooking space when the appliance door is opened. The accessories get hot. Use protective gloves or oven cloths.

- ▶ Take the food out of the cooking space when done.
- ▶ Wipe away traces of water or soiling with a soft cloth to prevent corrosion and unpleasant odours.
- ▶ Leave the appliance door open in the at-rest position until the cooking space has cooled down and dried out.



## 5.10 Switching the appliance off

- ▶ Press the  touch button.
  - An acoustic signal is emitted.
  - Any running operating mode or application is ended; if switched on, the timer, cooking space illumination or plate warmer will remain active.
  - « Residual heat» appears in the display.
  - If the food probe is plugged in, the food probe temperature is displayed. \*

\* Depending on the software version

- ▶ Press the  touch button again.
  - All touch buttons go out.
  - All functions are ended and switched off.

Or at the end of operation:

- ▶ Select the  option in the display.
  - An acoustic signal is emitted.
  - Any running operating mode or application is ended; if switched on, the timer, cooking space illumination or plate warmer will remain active.
  - The following appears in the display: « Residual heat».
  - If the food probe is plugged in, the food probe temperature is displayed. \*

\* Depending on the software version

- ▶ Press the  touch button.
  - All touch buttons go out.
  - All functions are ended and switched off.



The appliance is switched off if none of the touch buttons are illuminated any more and the display is dark.

The cooling fan can continue to run.

## 6 GourmetGuide

The  GourmetGuide encompasses several programmes which make preparing meals as easy as possible for you. The following programmes can be called up:

-  Recipes
-  Keep warm \*
-  Soft roasting

\* Depending on the software version

### 6.1 Recipe book

A recipe book contains recipes which are tailored to suit the particular appliance. These are already programmed into the appliance and run automatically once started.



The «Recipe book» function allows you to cook by following a recipe. To use this function, you must first order the recipe book (subject to charge) before you are able to activate it in the appliance.

The following recipe books are available for your appliance:

-  Bi Baking treats

#### Unlocking a recipe book





When you buy a recipe book, you receive a password which is used to unlock the recipe book in the appliance. After it has been unlocked, the recipes are displayed in the appliance.

- ▶ If the appliance is switched off, first press the adjusting knob.
- ▶ Press the  touch button.
- ▶ Select .
- ▶ Select the recipe book that you wish to unlock.
  - The following appears in the display: «Do you want to unlock the recipe book?».
- ▶ Select «Yes».
- ▶ Enter the password using the on-screen keypad and confirm by selecting .
- The recipe book is now unlocked.

## Starting a recipe



For recipes that do not require preheating, place the food in the cold cooking space.

- ▶ If the appliance is switched off, first press the adjusting knob.
- ▶ Press the  touch button.
- ▶ Select .
- ▶ Select the desired recipe book or  «Own recipes».
- ▶ To select a recipe, choose .
- ▶ Select a recipe.
  - The recipe settings are displayed.
- ▶ If you wish, set the end time or delayed start.



When cooking recipes from recipe books, a delayed start is only possible if the cooking space does not need to be preheated and the food does not need to be stirred or turned partway through, for example.

- ▶ To start the recipe, select .
  - The recipe starts.
  - The display shows the current recipe step, the time remaining in this step and the entire duration of the recipe.
  - The digital display shows the remaining time for the current recipe step.

## In the course of the recipe

In the course of the recipe, it may be necessary to open the appliance door, e.g. to turn over the food or to spread a topping over it. In such an instance, operation is paused and the display shows instructions on what to do next.

To continue the recipe, proceed as follows:

- ▶ Open the appliance door.
- ▶ Carry out the action, e.g. turn over food.
- ▶ Close appliance door and select  in the display.
  - The recipe will continue to run.





## Cancelling the recipe

- ▶ In the recipe settings, select .
  - The following appears in the display: «Should the current recipe be cancelled?»
- ▶ To abort the recipe, select «Yes».
  - The recipe is cancelled.

## 6.2 Own recipes

Up to 24 of your own favourite recipes can be created and saved. A recipe can consist of several steps with any operating modes, pauses and hold times, which run automatically once started. You can also change and save existing recipes.



### Creating your own recipe

- ▶ If the appliance is switched off: first press the adjusting knob.
- ▶ Press the  touch button.
- ▶ Select .
- ▶ Select .
- ▶ To create a new recipe, select .
  - The selection of operating modes appears in the display.

- ▶ Select the desired operating mode.
- ▶ Set the target temperature, duration, temperature or temperature level for step 1.

 If you are only making temperature settings, this step takes as long as is necessary for the cooking space to reach the required temperature.

- ▶ To confirm the settings, select ✓.
- ▶ To add a new step, select +.
- ▶ Set an operating mode, pause or hold time for step 2.

 For the intermediate step  «Hold», the heating continues to run and the cooking space temperature remains constant. For the intermediate step  «Pause», the cooking space is not heated any more and the temperature drops.

After a hold or pause step, a preheating stage can be set.

- ▶ To save the settings, select ✓.
  - The overview of the set steps is displayed.
- ▶ Set additional steps in the same way. A recipe can consist of up to 9 steps.
- ▶ To save the recipe, select .
  - The overview of the available storage spaces is displayed.
- ▶ Select the desired (empty) storage space and confirm.
- ▶ Enter the recipe name using the on-screen keypad and confirm by pressing ✓.
  - The recipe is now saved.
  - The following appears in the display: «Do you want to run the recipe?» If you do not wish to run the recipe, you will return to the recipes main menu.

## Step duration

The duration of a step depends on whether values have been set for the target temperature, duration, temperature or temperature level. If multiple values have been set, e.g. the duration and the temperature, only one of these takes priority for the step duration.

The table below shows the priorities in descending order:

	Setting
1	Target temperature
2	Duration
3	Temperature / temperature level

## Cancelling recipe entry/change

- ▶ Select  in the overview of the set steps.
  - The following appears in the display: «Do you really want to cancel the recipe entry?»
- ▶ To cancel the recipe entry, select «Yes».
  - The menu for your own recipes or, if a recipe from a recipe book was changed, the menu for the recipe book is displayed.

## Ending a step before time



This is only possible for  «Own recipes». If, for example when a recipe is running, you realize that the food or the cooking space is ready for the next step in the recipe even though the current step is still in progress, you can end the step before time.

- ▶ Select the symbol for target temperature, duration, temperature or temperature level in the operating mode settings. Pay attention to the priorities for the step duration as described under «Step duration».

- ▶ Set the displayed value to 0 or reduce it until it is less than the currently measured value.
- ▶ Press the adjusting knob to confirm.
  - The step is ended.
  - If it was the final step, the recipe ends too.
  - If it was not the final step, the next step starts.

### Changing recipes



Any recipe – from a recipe book as well as your own recipes – can be copied and changed.

- ▶ Select the desired recipe book or .
- ▶ Select .
- ▶ Choose a recipe.
  - An overview of the steps in the recipe is displayed.

### Changing a step

- ▶ Select the step to be changed.
- ▶ Make the settings and confirm with .



### Adding a step

- ▶ Select .
- ▶ Make the settings and confirm with .

### Deleting a step

- ▶ Select .
  - An overview of the steps in the recipe is displayed.
- ▶ Select the step.
  - The following appears in the display: «Do you want to delete this step?»
- ▶ To delete the step, select «Yes».
  - The step is deleted.

### Saving a changed recipe

- ▶ Select .
- ▶ Select storage space, enter the recipe name and confirm by pressing .
  - The changed recipe is now saved.





A storage space that is already being used can be overwritten.

Recipes that have been amended from recipe books are not saved in the recipe book, but under  «Own recipes». The original recipe remains in the corresponding recipe book.

### Deleting your own recipe

Any recipe in  «Own recipes» can be deleted.

- ▶ Select  «Own recipes».
- ▶ Select .
- ▶ Select the recipe to be deleted.
  - The following appears in the display: «Do you want to delete this recipe?»
- ▶ To delete the recipe, select «Yes».
  - The recipe is deleted.

## 6.3 Soft roasting

### How it functions

The  soft roasting function allows high-quality cuts of meat to be prepared gently. You can select exactly when the cooking process is complete, irrespective of the weight and thickness of the meat. The temperature is automatically regulated.

### Tips for an optimal result

- Take the meat out of the refrigerator some 30–60 minutes before soft roasting.
- Weight of meat: 500–2000 g
- Meat thickness: at least 4 cm
- Quality: lean, high-quality meat

### Soft roasting table for «Soft roasting seared»

Cut of meat	Degree of doneness	Recommended target temperature °C
Fillet of veal	rare	58
	medium	62
Rump or loin of veal	medium	63
Shoulder of veal	medium	72
Neck of veal	medium	78
Fillet of beef	rare	53
	medium	57
Rib-eye or sirloin	rare	53
	medium	57
Rump of beef	medium	63
Chuck of beef	medium	68
Shoulder of beef	medium	72
Rump or loin of pork	medium	65
Neck of pork	medium	80
Leg of lamb	rare	63
	medium	67
Freely select meat type	–	70

### «Soft roasting seared»

- ▶ Season or marinate the meat.



Remove any marinade made with herbs, mustard, etc. from the meat before searing. These ingredients burn easily.

- ▶ Salt the meat immediately before searing.
- ▶ Briefly sear the meat all over for no longer than 5 minutes.
- ▶ Then place the meat in a glass or porcelain roasting dish.



If you do not intend to sear the meat until after the soft roasting, lower the recommended target temperature by around 3–4 °C.

- ▶ Insert the food probe into the meat so that the tip is in the centre of the thickest part.





The food probe must be inserted as far into the middle of the meat as possible to get a correct reading of the food probe temperature. The temperature inside the meat is crucial for optimal results at the end of cooking.

- ▶ Put the wire shelf at level 2 and place the dish on it.
- ▶ Insert the food probe plug into the socket.
- ▶ Start  «Soft roasting seared» (see page 27).

### Selecting and starting soft roasting





The longer the meat is cooked, the more tender and succulent it becomes. This applies particularly for thicker pieces of meat. The target temperature cannot be changed once soft roasting has started.

- ▶ If the appliance is switched off, first press the adjusting knob.
- ▶ Press the  touch button.
- ▶ Select .
- ▶ Select the desired soft roasting method.
- ▶ Select the desired type of meat.
- ▶ Select the desired cut.



▶ If the desired type of meat or cut cannot be selected, select the  «Freely select meat type» option.

- ▶ Select the degree of doneness (not possible for  «Freely select meat type»).
- The operating mode settings are displayed.
- A recommended value appears above the target temperature.
- ▶ Adjust the recommended value if necessary and set a delayed start if you wish.
- ▶ To start soft roasting, select .





The food probe must be plugged in.

- Soft roasting starts.
- The set target temperature, the current food probe temperature and the remaining time are displayed.
- The remaining time appears in the digital display.







The appliance door must be closed during operation. If the appliance door is opened while soft roasting is running, the operation is interrupted and then, after a short time, cancelled.

### Inadvertently interrupting the programme

- ▶ If the  touch button is pressed, the soft roasting programme is interrupted.
  - The following appears in the display: «Should  be cancelled?»
- ▶ To continue soft roasting, select «No».
  - Operation is continued.

### Cancelling / ending soft roasting before time

- ▶ Select  in the soft roasting settings or press the  touch button.
  - The following appears in the display: «Should  be cancelled?».
- ▶ Select «Yes».
  - Operation is cancelled.
- ▶ To switch off the appliance, press the .



If you accidentally pressed «Yes» or you wish to finish cooking the meat, you must press the  touch button and select an operating mode. «Soft roasting» is not suitable for already cooked meat.

### 6.4 Keep warm \*

\* Depending on the software version

Cooked foods can be kept warm using the  «Keep warm» setting.



If the cooking space is already hot, open the appliance door and allow the cooking space to cool down for 3 to 4 minutes before starting the «Keep warm» function. This ensures that the food does not overcook. The longer the food is kept warm, the greater the changes may be to the consistency of the food.

## 7 EasyCook

 EasyCook helps you to prepare any food simply and conveniently. After choosing the food group and food, the appliance suggests the suitable operating modes or Gourmet-Guide applications, including the settings and accessories.



The brochure of the same name, which you received with the operating instructions, contains the same settings information in paper form. The values given for temperature or temperature levels and duration serve only as guide. They may vary depending on the type and size of the food as well as on individual preference.

### 7.1 Overview of food groups

Foods are categorized into different groups; an item of food can appear in more than one group.

The following food groups can be selected:



Fruit



Mushrooms



Potatoes



Meat



Poultry



Fish and seafood



Flans and pizza



Bakery products



Baked dishes and gratins

### 7.2 Selecting and starting foods



A delayed start is only possible for applications where preheating is not required and is only suitable for food that does not need to be refrigerated or to rise.

- ▶ If the appliance is switched off: first press the adjusting knob.
- ▶ Press the  touch button.
  - The overview of food groups is displayed.
- ▶ Select the food group.
- ▶ Choose the desired type of food.
- ▶ If necessary: select the shape (whole, pieces, etc).
- ▶ If necessary: select the preparation method (cooking, baking, etc.).

- The display contains information about:
  - Temperature
  - Duration
  - Preheating necessary / not necessary
  - Accessories needed
  - Level
  - Possible tips
- ▶ Select ✓.
- ▶ The operating mode summary is displayed.
- ▶ To start operation, select ►.



You can change the set values to a limited extent.

## 8 Favourites

Up to 24 operating modes, GourmetGuide and EasyCook applications together with the settings made can be saved as favourites.

### 8.1 Creating favourites

- ▶ Select an operating mode, GourmetGuide or EasyCook application.
- ▶ Make the settings.
- ▶ Press the ♥ touch button.
  - The favourites menu opens.
- ▶ Select a storage space and confirm.
- ▶ Enter the name of the favourite using the on-screen keypad and confirm.
  - The favourite is saved.

### 8.2 Selecting and starting favourites

- ▶ Press the ♥ touch button.
- ▶ Choose the desired favourite and select «Yes».
- ▶ To start the favourite, select ►.
  - The favourite starts.

### 8.3 Changing favourites

- ▶ Select the desired favourites.
- ▶ Adjust the settings as required.
- ▶ Press the ♥ touch button.
- ▶ Select the storage space or favourite that is to be overwritten.
- ▶ Enter the favourite name or overwrite as appropriate.
  - The changed favourite is saved.

### 8.4 Deleting favourites



- ▶ If the appliance has another menu open, press the ♥ touch button.
- ▶ Select ☰.
- ▶ Select the favourite to be deleted.
  - The following appears in the display: «Do you want to delete this favourite?».
- ▶ To delete the favourite, select «Yes».
  - The favourite is deleted.

## 9 Tips and tricks

### 9.1 Unsatisfactory cooking result...

#### ... when baking and roasting





Result	Solution
<ul style="list-style-type: none"> <li>The baking or roast looks good on the outside but is still doughy or raw on the inside.</li> </ul>	<ul style="list-style-type: none"> <li>Next time, set a lower temperature and lengthen the operating time.</li> </ul>
<ul style="list-style-type: none"> <li>The cake collapses.</li> </ul>	<ul style="list-style-type: none"> <li>Check that the settings used correspond to those recommended in «EasyCook».</li> <li>Next time, set a lower temperature and lengthen the operating time.</li> <li>Stir the cake mixture well. When finished, bake immediately.</li> <li>For whisked sponges, beat the egg yolks / egg whites to a foam a little longer and then carefully fold into the mixture. When finished, bake immediately.</li> <li>Follow the instructions on how much baking powder to add.</li> </ul>

Result	Solution
<ul style="list-style-type: none"> <li>The baking has browned unevenly.</li> </ul>	<ul style="list-style-type: none"> <li>Next time, set a lower temperature and adjust the operating time.</li> <li>If using ,  and , check that the levels used correspond to «EasyCook».</li> <li>Do not push baking tins or bulky foodstuffs right to the back of the cooking space.</li> </ul>
<ul style="list-style-type: none"> <li>The baked goods have come out lighter on one baking tray than on the other.</li> </ul>	<ul style="list-style-type: none"> <li>Check that the settings used correspond to those recommended in «EasyCook».</li> </ul>



Some uneven browning is normal. More even browning is generally achieved at lower temperatures.

### 9.2 Saving energy

The  and  operating modes consume less energy than the  and  operating modes.



- ▶ Avoid opening the appliance door frequently.
- ▶ Only switch the illumination on when needed.
- ▶ For gratins, use the residual heat: for cooking times over 30 minutes, switch the appliance off 5–10 minutes before the end of the operating time.
- ▶ Minimize preheating.
- ▶ Only preheat the cooking space if the cooking or baking results depend on it.



Power consumption can be reduced to a minimum by selecting «Hide time» in the user settings. Despite EcoStandby, all safety functions remain active.

## 10 User settings



### 10.1 Overview of user settings

	Language		Assistance functions
	Display		Temperature
	Date		Childproof lock
	Clock		Appliance information
	Notifications		Demo mode
	Pyrolytic self-cleaning (depending on model)		Factory settings
	Loudness		

### 10.2 Adjusting user settings

- ▶ If the appliance is switched off, first press the adjusting knob.
- ▶ Press the  touch button.
- The user settings main menu appears in the display:



- ▶ Select the desired user setting or submenu.
- ▶ Adjust the desired user setting and press the adjusting knob to confirm.
  - Either the user settings main menu or the relevant submenu appears in the display.
- ▶ To exit a submenu and return to the user settings main menu, select .
- ▶ To exit the user settings, press a different touch button or the  touch button.

 All user settings are retained in the event of a power failure.

### 10.3 Language

The language in the display can be changed. Different languages are available for selection.

### 10.4 Display

#### Contrast

With this function, the readability of the display can be adjusted based on how the appliance is installed.

#### Brightness

The brightness of the display can be changed.

### Start screen \*

\* Depending on the software version

With this user setting, you can determine the menu that is displayed when you start the appliance. The following menus can be selected:

- Operating modes (factory setting)
- GourmetGuide
- EasyCook
- Favourites

### Appliance switch-off time

If no operating mode is running but the appliance is switched on, it is automatically switched off after a certain period of time without any user interaction. Example: After the end of an operating mode.



The appliance switch-off time can be set between 3 and 30 minutes; the factory setting is 15 minutes.

## 10.5 Date

The date can be called up and changed.

## 10.6 Clock

The following time functions are available:

-  Time
- 12/24 Time format
-  Time display
-  Mains synchronization

### Time format

The time can be displayed in the European 24-hour time format or the US 12-hour format (a.m./p.m.).

### Time display

With the «Show time» setting (factory setting), the time is dimmed between 00:00 and 06:00 (24-hour format) or 12:00 a.m. and 06:00 a.m. (12-hour format).

If «Hide time» is selected, the displays are not illuminated when the appliance is off.



To reduce power consumption to a minimum, select «Hide time» in the user settings. Despite EcoStandby, all safety functions remain active.

### Mains synchronization

Mains synchronization synchronizes the appliance clock with the mains frequency. Irregular mains frequency can cause the clock to not run correctly. A pulse generator inside the appliance is used when mains synchronization is switched off.

## 10.7 Notifications

Acoustic signals and instruction messages can be switched off or disabled. Essential acoustic signals (such as the timer, end of operation and switch appliance off) cannot be switched off or disabled.

## 10.8 Pyrolytic cleaning of appliance

This function enables pyrolytic cleaning of the cooking space.  
See Pyrolytic self-cleaning (see page 38).

## 10.9 Loudness

The acoustic signal can be set at one of two levels of loudness or can be completely switched off.



An acoustic signal is emitted in the event of a malfunction even if the setting is set to «off».

A short acoustic signal is emitted when the appliance is switched off even if the setting is set to «off» (safety function).

## 10.10 Assistance functions

### Illumination

The «Automatic» setting switches on the cooking space illumination:

- 3 minutes before a cooking process ends, e.g. in the case of an automatic programme or an operating mode with a set duration, or
- if the operation is ended before time, i.e. cancelled (using ■ or the ⏻ touch button).

Depending on the model, the illumination also switches on when the appliance door is opened.



Press the ⏻ touch button to switch the illumination on or off at any time.

If the illumination is not switched off, it will go off automatically within 5 minutes to save energy.

### Fast heating

With the «Automatic» setting, fast heating is switched on automatically wherever possible.

### Press and go

⏻ «Press and go» refers to the period of time after which an operating mode/programme starts automatically as long as all necessary settings are available or have been made. Adjusting the settings restarts the countdown.

⏻ «Press and go» can be switched on or off.

When ⏻ «Press and go» is activated, values between 10 seconds and 1 minute are possible; the factory setting is 20 seconds.

## 10.11 Temperature

### Temperature unit

The temperature can be displayed in «°C» or «°F».

- °C: Degrees Celsius
- °F: Degrees Fahrenheit

### Default value for soft roasting

The default value is the target temperature that is automatically set when soft roasting. With this user setting, it can be increased or decreased by up to 4 °C; the setting then applies for all cuts of meat.

Example: When using «Soft roasting seared» with a 2 °C increase in the default value, a «medium» fillet of beef is cooked to a target temperature of 59 °C instead of 57 °C.

## 10.12 Childproof lock

The childproof lock is to prevent children accidentally switching on the appliance. When the childproof lock is activated, the appliance can only be operated after first entering a code. The code is displayed in reverse order when unlocking.



The childproof lock activates 3 minutes after the appliance is switched off.

## 10.13 Appliance information

Under  «Appliance information», you will find:

- The article number and serial number (SN) of your appliance
- The software versions of your appliance as well as the acoustic signals and background images currently being used (depending on model)

## 10.14 Demo mode

In demo mode, almost all the appliance functions are available but it is not possible to cook with the appliance. This ensures operating safety during product demonstrations and consultations.

It is only possible to switch demo mode on and off with a safety code.

## 10.15 Factory settings

If one or more user settings have been changed, these can be reset to the factory settings.

# 11 Care and maintenance



### **Risk of burns from hot surfaces!**

Allow the appliance and the accessories to cool down before cleaning them.

### **Damage to the appliance from incorrect treatment!**

Do not use any abrasive or caustic cleaning agents, metal scrapers that are sharp or scratch, steel wool, abrasive scouring pads, etc. These products will damage the surfaces. Glass surfaces that are scratched can crack.

Never use a steam cleaner to clean the appliance.

## 11.1 Cleaning the exterior

- ▶ Remove any soiling or excess cleaning solution immediately.
- ▶ Clean the surfaces with a soft cloth dampened with water and a little washing-up liquid – for metallic surfaces rub in the direction of the original polish lines.
- ▶ Wipe dry with a soft cloth.

## 11.2 Cleaning the cooking space



### **Incorrect handling can result in damage to the appliance!**

Do not bend the cooking space temperature sensor or heating elements.

Do not scour the surface. This can damage the enamel.

- ▶ Remove any soiling from the cooking space while still hand warm. Use a soft cloth dampened with water and a little washing-up liquid. Wipe dry with a soft cloth.

In the case of appliances without pyrolysis:

- ▶ Use a commercially available oven cleaner and follow the manufacturer's instructions.



### Never clean appliances with pyrolysis using oven cleaner

as the surface could otherwise be damaged.

- ▶ Carry out pyrolysis in the case of stubborn dirt deposits (see page 38).

## 11.3 Cleaning the appliance door

- ▶ Clean the appliance door with a soft cloth dampened with water and a little washing-up liquid.
- ▶ Dry with a soft cloth.

### Removing the appliance door



#### Risk of injury from moving parts!

Be careful not to put fingers in the door hinges. The appliance door is heavy. When removing and reassembling the appliance door, hold it firmly at the sides with both hands.

- ▶ Open the appliance door as far as it will go.
- ▶ Fold the clips **2** on both door hinges **1** forward.

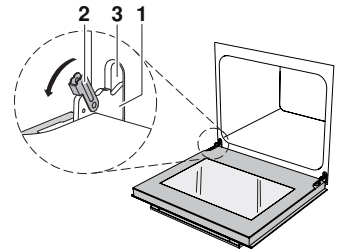

- ▶ Close the appliance door as far as its at-rest position (about 30°).
- ▶ Lift the appliance door out at an angle.

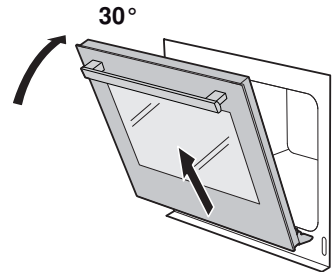

### Reassembling the appliance door

- ▶ From the front, push both hinges **1** into the opening **3**.
- ▶ Open the appliance door as far as it will go and close back the clips **2**.

## 11.4 Cleaning the door seal

- ▶ Clean the door seal with a soft cloth dampened with water, but do not use any cleaning agent.
- ▶ Wipe dry with a soft cloth.

## 11.5 Replacing the door seal

- ▶ Remove the damaged door seal.
- ▶ Clean the groove **1** with a slightly damp cloth.
- ▶ Press the ends of the new door seal **2** into the groove in the centre of the frame at the bottom.



The ends must touch each other but not overlap.

- ▶ Ensure that only the thinner part **3** of the seal is pressed into the groove; the thicker part **4** must not be in the groove.

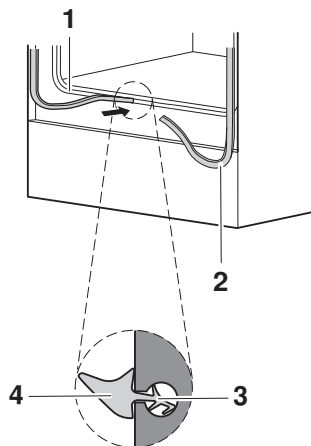

- ▶ Starting from the bottom, press the seal evenly into the groove.

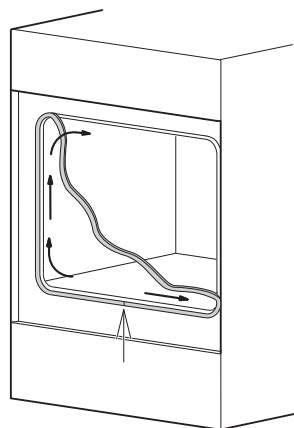

## 11.6 Replacing the door seal on pyrolysis appliances

- ▶ Remove the damaged door seal.
- ▶ Clean the groove **3** with a slightly damp cloth.
- ▶ Press the new door seal **1** into the groove, with the seam joint **2** not at centre bottom of the frame

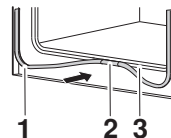

- ▶ Ensure that only the thinner part **4** of the seal is pressed into the groove; the thicker part **5** must not be in the groove.

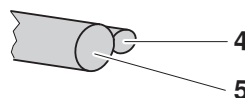

- ▶ Starting from the bottom, press the seal evenly into the groove.

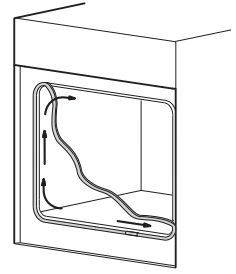

## 11.7 Replacing the halogen light bulb



### **WARNING: Risk of electric shock!**

Disconnect the appliance from the mains power supply before replacing the halogen light bulb.

Risk of burns from hot surfaces!

Allow the halogen light bulb and the appliance to cool down before replacing the halogen light bulb.



It is recommended to replace both halogen lights at the same time, even if one is still functioning.

- ▶ Remove the left shelf guide.
- ▶ Place the screw driver along the middle of the edge of the glass and carefully remove the glass light cover **1** from its fixture.
- ▶ Take out the defective halogen light bulb.
- ▶ Carefully fit the new halogen light bulb.

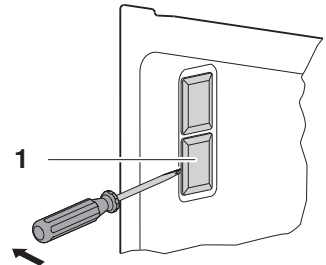

Do not touch the halogen light bulb with bare hands. Instead, use a fine, dry, grease-free cloth.

- ▶ Press the glass light cover **1** back into its fixture.
- ▶ Repeat the same process to replace the second halogen light.
- ▶ Replace the shelf guides.
- ▶ Switch the power supply back on.

## 11.8 Cleaning the accessories and shelf guides

- The wire shelf and shelf guides can be cleaned in the dishwasher.
- The baking tray can be cleaned in the dishwasher; however, this will affect its non-stick properties.

### Removing and reassembling the shelf guides

- ▶ Push the shelf guides at the top backwards and take out of the opening.

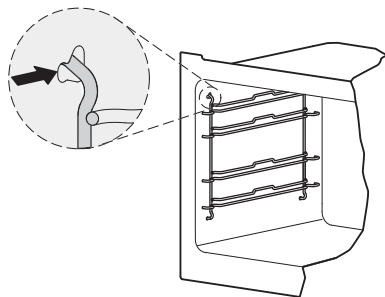

- ▶ Swing the shelf guide into the middle of the cooking space and remove from the opening at the bottom.
- ▶ Put back in reverse order.

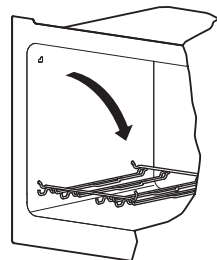

## 11.9 Pyrolytic self-cleaning



### Danger of explosion through deposits and cleaning agents!

Remove grease or oil deposits. Do not use any chemical cleaning agents. Deposits could give rise to chemical reactions and destroy the enamel. Poisonous fumes could escape.

Do not leave the appliance unattended.

Risk of burns from hot surfaces! The appliance front gets hotter than during normal operation.

There is likely to be some smoke given off for a short period of time so ventilate the room during pyrolysis.

In pyrolytic self-cleaning, any soiling is burned off at a high temperature.

### Possible settings

- |   |                    |                            |
|---|--------------------|----------------------------|
| ▪ | ⋮⋮⋮ Lightly soiled | Cleaning duration: 1½ hrs. |
| ▪ | ⋮⋮⋮ Medium soiled  | Cleaning duration: 2 hrs.  |
| ▪ | ⋮⋮⋮ Heavily soiled | Cleaning duration: 2½ hrs. |



The pyrolytic self-cleaning process – including cooling down – takes about 4–5 hours.

As long as the temperature is over 300 °C, the illumination switches off and cannot be switched back on.





Over time with use the cooking space can turn matt. Fruit acid and fatty acid deposits can leave stains. This will not affect the cooking or baking characteristics of the appliance nor affect its functioning.

## Selecting and starting pyrolytic self-cleaning





### Damage to accessories from self-cleaning!

Remove accessories, shelf guides, full extension roller runners, cookware and any other objects from out of the cooking space. Otherwise they can become discoloured and their surface rough. The rolling properties of full extension roller runners deteriorate.

- ▶ Close the appliance door.
- ▶ If the appliance is switched off: first press the adjusting knob.
- ▶ Press the  touch button.
- ▶ Select .
- ▶ Select the degree of soiling.
  - The calculated end time for the pyrolytic self-cleaning process is shown in the display above .
- ▶ To start the pyrolytic self-cleaning process, select .
  - The appliance door locks.

## Delayed start

The start of pyrolytic self-cleaning can be delayed, for example, to take advantage of lower electricity tariffs.

- ▶ Select  before starting.
- ▶ Set the desired end time.
- ▶ Select .
  - The appliance remains switched off until the calculated automatic start.

## Cancelling

- ▶ Select  in the display.
  - Pyrolytic self-cleaning is cancelled.
- ▶ The residual heat appears in the display.
- ▶ The appliance door remains locked until the temperature drops below 300 °C.

## End

The appliance door cannot be opened until the temperature has dropped below 300 °C.

- ▶ Wait until the appliance has cooled to hand warm to remove any residue left behind using a soft cloth dampened with water. Do not use cleaning agents.

## 12 Trouble-shooting

### 12.1 What to do if ...

This section lists faults that can be solved simply by following the instructions given. If another fault is displayed or the fault cannot be remedied, please call Customer Services.



Before calling Customer Services, please note down the error message in full.

Fxx/Exxx see operating instructions

SNxxxxx xxxxxx.

#### ... the appliance is not working

Possible cause	Solution
<ul style="list-style-type: none"> <li>▪ A household fuse or circuit breaker has tripped.</li> </ul>	<ul style="list-style-type: none"> <li>▶ Change the fuse.</li> <li>▶ Reset the circuit breaker.</li> </ul>
<ul style="list-style-type: none"> <li>▪ The fuse or circuit breaker keeps blowing.</li> </ul>	<ul style="list-style-type: none"> <li>▶ Call Customer Services.</li> </ul>
<ul style="list-style-type: none"> <li>▪ An interruption in the mains power supply.</li> </ul>	<ul style="list-style-type: none"> <li>▶ Check the power supply.</li> </ul>
<ul style="list-style-type: none"> <li>▪ Demo mode is switched on.</li> </ul>	<p>It is only possible to switch off demo mode with a safety code.</p> <ul style="list-style-type: none"> <li>▶ Call Customer Services.</li> </ul>
<ul style="list-style-type: none"> <li>▪ The appliance is faulty.</li> </ul>	<ul style="list-style-type: none"> <li>▶ Call Customer Services.</li> </ul>

#### ... the appliance door cannot be opened

Possible cause	Solution
<ul style="list-style-type: none"> <li>▪ The temperature of the cooking space is over 300 °C.</li> </ul>	<ul style="list-style-type: none"> <li>▶ Wait for it to cool down.</li> </ul> <p>The appliance door cannot be opened until the temperature of the cooking space has dropped below 300 °C.</p>
<ul style="list-style-type: none"> <li>▪ Pyrolytic self-cleaning is running.</li> </ul>	<ul style="list-style-type: none"> <li>▶ Wait until pyrolytic self-cleaning has finished.</li> </ul>

#### ... just the illumination is not working

Possible cause	Solution
<ul style="list-style-type: none"> <li>▪ The halogen light is defective.</li> </ul>	<ul style="list-style-type: none"> <li>▶ Switch off the oven.</li> <li>▶ Disconnect the appliance from the electricity supply.</li> <li>▶ Replace the halogen light bulb.</li> </ul>

**... the cooking time seems unusually long**

Possible cause	Solution
<ul style="list-style-type: none"> <li>The appliance only has a single-phase connection.</li> </ul>	<ul style="list-style-type: none"> <li>▶ Establish a two-phase connection.</li> </ul>

**... when grilling, thick smoke is given off**

Possible cause	Solution
<ul style="list-style-type: none"> <li>The food is too near to the heating elements.</li> </ul>	<ul style="list-style-type: none"> <li>▶ Check that the level selected corresponds to the «EasyCook».</li> </ul>
<ul style="list-style-type: none"> <li>Grill setting is too high.</li> </ul>	<ul style="list-style-type: none"> <li>▶ Reduce the grill setting.</li> </ul>

**... the food probe temperature is not displayed**

Possible cause	Solution
<ul style="list-style-type: none"> <li>The food probe is not plugged in correctly.</li> </ul>	<ul style="list-style-type: none"> <li>▶ Check whether the food probe is correctly plugged into the socket.</li> <li>▶ Check whether the food probe is correctly inserted in the food: The tip must be in the centre of the thickest part.</li> </ul>
<ul style="list-style-type: none"> <li>In the selected automatic programme, the food probe cannot be used; the <math>\Lambda^{\circ}\text{C}</math> symbol is illuminated in grey.</li> </ul>	<ul style="list-style-type: none"> <li>▶ If you wish to use the food probe in spite of this, change to the  operating mode menu and set a suitable operating mode.</li> </ul>
<ul style="list-style-type: none"> <li>The food probe or the socket is defective.</li> </ul>	<ul style="list-style-type: none"> <li>▶ Call Customer Services.</li> </ul>



The food probe temperature is never displayed during the heating process.

**... the appliance makes noises during operation**

Possible cause	Solution
<ul style="list-style-type: none"> <li>The appliance may emit noise when operating (e.g. switching and pumping noises).</li> </ul>	<ul style="list-style-type: none"> <li>Such noise is normal.</li> </ul>

**... the clock is not running correctly**

Possible cause	Solution
<ul style="list-style-type: none"> <li>Irregular mains frequency</li> </ul>	<ul style="list-style-type: none"> <li>▶ Switch off the mains synchronization.</li> </ul>
<ul style="list-style-type: none"> <li>Internal pulse generator is imprecise when mains synchronization is switched off.</li> </ul>	<ul style="list-style-type: none"> <li>▶ Call Customer Services.</li> </ul>

**... the following appears in the display**

FX/EXX see operating instructions

SN XXX XXXXXX

Possible cause	Solution
<ul style="list-style-type: none"> <li>▪ Various situations can lead to an error message.</li> </ul>	<ul style="list-style-type: none"> <li>▶ Cancel the error message by pressing the ⏻ touch button.</li> <li>▶ Disconnect from the power supply for about 1 minute.</li> <li>▶ Reconnect the power supply.</li> <li>▶ If the error appears again, note down the error message in full along with the serial number (SN; see identification plate).</li> <li>▶ Disconnect from the power supply.</li> <li>▶ Call Customer Services.</li> </ul>

**... the following appears in the display**

UX/EXX see operating instructions

SN XXX XXXXXX

Possible cause	Solution
<ul style="list-style-type: none"> <li>▪ An interruption in the power supply.</li> </ul>	<ul style="list-style-type: none"> <li>▶ Cancel the error message by pressing the ⏻ button.</li> <li>▶ Disconnect from the power supply for about 1 minute.</li> <li>▶ Reconnect the power supply.</li> <li>▶ If the error appears again, note down the error message in full along with the serial number (SN; see identification plate).</li> <li>▶ Disconnect from the power supply.</li> <li>▶ Call Customer Services.</li> </ul>

**12.2 After a power failure**

The user settings remain unchanged.

**Brief power failure during operation**

- The current operation of the appliance is cancelled.
- The following appears in the display when the appliance is switched on: «Power failure. Operation cancelled».
- ▶ To cancel the message, select ✓.
  - The operating modes menu appears in the display.

**Prolonged power failure****Variant 1 \***

\* Depending on the software version

The appliance goes through its initial set-up process after a prolonged power failure. However, only the language and time need to be reset to enable the appliance to be operated again. It is not necessary to make any other settings.

### Variant 2 \*

\* Depending on the software version

The appliance goes through its initial set-up process after a prolonged power failure. However, only the time needs to be reset to enable the appliance to be operated again. It is not necessary to make any other settings.

- The following appears in the display when the appliance is switched on: «Power failure. Set time.»
- ▶ To confirm the message, select ✓.
  - The «Clock» menu in the user settings appears in the display.
- ▶ Select ⌚, set the time and confirm.
  - The «Clock» menu appears again in the display.
- ▶ Select ↶.
  - The following appears in the display: «Do you want to continue with the initial start-up?»
- ▶ To change other user settings, select «Yes».
  - The relevant user settings menu appears in the display.
- ▶ If no other user settings are to be changed, select «No».
  - The appliance is ready for operation again.

## 13 Accessories and spare parts

The accessories listed below, as well as spare parts, can be ordered in addition to the scope of delivery of the appliance. Ordering is subject to charge, except in the event of warranty claims. Please give product family of the appliance and exact designation of the accessory or spare part when ordering parts.

### 13.1 Accessories



TopClean baking tray



Wire shelf



Food probe with straight handle



EasyCook brochure



Recipe book

## 13.2 Special accessories

For information see: [www.vzug.com](http://www.vzug.com)

## 13.3 Spare parts

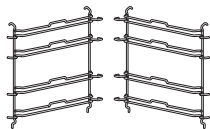

Shelf guides left/right

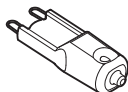

Halogen light bulb

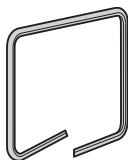

Door seal

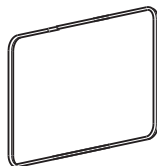

Door seal for pyrolytic appliances



The halogen light bulb is also available from specialist retailers.

## 14 Technical data

### External dimensions

- ▶ See installation instructions

### Electrical connection

- ▶ See identification plate 1

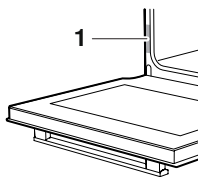

### 14.1 Note for testing institutes

The energy efficiency class according to EN 50304 / EN 60350 is determined using the and operating modes.

Placing thermocouples between the appliance door and the seal can cause lack of leak-tightness and thus measuring errors.

The usable volume within the meaning of EN 50304 / EN 60350 is obtained with the shelf guides disassembled.

## 14.2 Temperature measurement

The temperature inside the cooking space is measured when the cooking space is empty according to an internationally accepted standard. Own measurements can be imprecise and are not suitable for checking the accuracy of the temperature.

## 14.3 Product fiche

In accordance with EU Regulation No.: 66/2014





Brand	–	V-ZUG Ltd
Type of appliance	–	Oven
Model designation	–	BCSE   BCSE DV   BCSEP   BCSEP DV
Mass of appliance	kg	48   48   52   54
Number of cavities	–	1
Heat source per cavity	–	Electric
Volume per cavity	l	68
Energy consumption in conventional mode <sup>1)</sup>	kWh/cycle	0.93   0.93   0.96   0.96
Energy consumption in hot air/forced convection mode <sup>2)</sup>	kWh/cycle	0.79   0.79   0.79   0.79
Energy-efficiency index per cavity <sup>3)</sup>	–	94.5
Measurement and calculation methods used	–	IEC 60350

1) Required to heat a standardized load in cavity

2) Required to heat a standardized load in cavity

3) Measurement methods: See EU Regulation No. 66/2014, Annex II, Chapter 1

### Saving energy while cooking

The  and  operating modes consume less energy than the  and  operating modes.

- ▶ Avoid opening the appliance door frequently.
- ▶ For gratins, use the residual heat: for cooking times over 30 minutes, switch the appliance off 5–10 minutes before the end of the operating time.
- ▶ Minimize preheating.
- ▶ Only preheat the cooking space if the cooking or baking results depend on it.

## 14.4 EcoStandby

To prevent unnecessary energy consumption, the appliance is equipped with the automatic energy-saving «EcoStandby» function.



To reduce power consumption to a minimum, select «Hide time» in the user settings. Despite EcoStandby, all safety functions remain active.

## 14.5 Reference to «Open Source» licence

Your appliance contains Newlib open-source software. This is subject to the licensing conditions specified in Section 4.1 (4.1.1–4.1.8; 4.1.9; 4.1.10; 4.1.14–4.1.16) of the enclosed open-source software licence text document.

## 15 Disposal

### 15.1 Packaging



Never allow children to play with packaging material due to the danger of injury or suffocation. Store the packaging material in a safe location or dispose of it in an environmentally-friendly way.

### 15.2 Safety

Render the appliance unusable to prevent accidents caused by improper use (e.g. through children playing):

- ▶ Disconnect the appliance from the mains. With a fixed appliance, this is to be carried out by a qualified electrician. Then cut the mains cable off flush with the appliance.

### 15.3 Disposal



-  The «crossed out wheeled bin» symbol requires the separate collection of waste electrical and electronic equipment (WEEE). Such equipment can contain hazardous, environmentally harmful materials.
- These appliances are to be handed over to a designated collection point for the recycling of electrical and electronic equipment and must not be disposed of with unsorted household waste. And in this way, you will be helping to protect resources and the environment.
- For more information, please contact the local authorities.

# 16 Index

<b>A</b>	
Accessories .....	12, 43
Cleaning .....	38
Acoustic signals .....	32
Appliance disposal .....	46
Appliance door	
Cleaning .....	35
Removing .....	35
Appliance information .....	34
Appliance switch-off time .....	32
<b>B</b>	
Baking tray .....	12
Before using for the first time .....	6
Bottom heat .....	11, 15
Brightness .....	31
<b>C</b>	
Cancelling	
Changing recipe .....	24
Creating own recipe .....	24
Operating mode .....	19
Recipes .....	23
Cleaning .....	34
Accessories .....	38
Cooking space .....	34
Door seal .....	35
Shelf guides .....	38
Cleaning the exterior .....	34
Clock .....	32
Construction .....	10
Contrast .....	31
Cooking space	
Cleaning .....	34
Temperature measurement .....	45
<b>D</b>	
Delayed start .....	18
Pyrolytic self-cleaning .....	39
Deleting	
Favourites .....	29
Own recipe .....	25
Demo mode .....	34
Disposal .....	46
Door seal	
Cleaning .....	35
Replacing .....	36
Replacing on pyrolysis appliance .....	36
Duration .....	17
Recipe step .....	24
<b>E</b>	
EasyCook .....	28, 43
Food groups .....	28
EcoStandby .....	45
Electrical connection .....	44
End .....	18
Extending operation .....	21
External dimensions .....	44
<b>F</b>	
F and E messages .....	42
Factory settings .....	34
Fast heating .....	16, 33
Automatic switch-on .....	33
Favourites .....	29
Changing .....	29
Creating .....	29
Deleting .....	29
Starting .....	29
Food probe .....	12, 18
Food probe temperature .....	18
Measure only .....	19
<b>G</b>	
Grill .....	14
Grill-forced convection .....	14
<b>H</b>	
Halogen light bulb .....	37
Hold .....	24
Hot air .....	13
Hot air humid .....	15
Hot air with bottom heat .....	14
<b>I</b>	
Identification plate .....	44
Illumination .....	33, 40
Initial set-up .....	6, 9
Instruction message .....	32
Instructions for use .....	6
<b>K</b>	
Keep warm .....	28
<b>L</b>	
Language .....	31
Levels .....	11
Long cooking time .....	41
Loudness .....	33
<b>M</b>	
Mains synchronization .....	32

Maintenance .....	34	Starting.....	39
Model designation .....	2	Service & Support.....	51
Model number .....	2, 34	Setting the time .....	31
<b>N</b>		Shelf guides	
Notes .....	49	Cleaning .....	38
<b>O</b>		Removing .....	38
Operating and display elements.....	10	SN .....	34
Operating mode		Socket.....	11
Cancelling .....	19	Soft roasting.....	26
Changing.....	20	Default value.....	33
Selecting.....	16	Positioning the food probe .....	26
Operating mode settings.....	17	Seared .....	26
Changing.....	17	Starting.....	27
Checking.....	17	Switching off before time .....	27
Operation.....	16	Software versions.....	34
Own recipes.....	23	Spare parts .....	43, 44
Creating .....	23	Special accessories .....	12, 44
Deleting .....	25	Start screen.....	32
<b>P</b>		Switching off before time.....	19
Pause .....	24	Symbols.....	5
Plate warmer.....	12	<b>T</b>	
Power failure .....	42	Target temperature .....	18
Preheating .....	30, 45	Technical data .....	44
Press and go .....	17, 33	Technical questions.....	51
Pyrolytic self-cleaning.....	38	Temperature sensor .....	11
Cancelling .....	39	Temperature unit.....	33
Starting.....	39	Testing institutes .....	44
<b>Q</b>		Time display.....	32
Quick instructions .....	52	Time format.....	32
<b>R</b>		Timer .....	20
Recipe book .....	22, 43	Tips and tricks .....	30
Unlocking .....	22	Top/bottom heat .....	13
Recipes .....	22	Top/bottom heat humid.....	15
Action required.....	23	Touch buttons.....	11
Changing.....	25	Type.....	2
Copying .....	25	<b>U</b>	
Creating own .....	23	U and E messages.....	42
Ending a step before time .....	24	Uneven browning.....	30
Step duration .....	24	User settings.....	31
<b>S</b>		Adjusting.....	31
Safety precautions		Overview.....	31
Before using for the first time.....	6	Using for the first time.....	9
Correct use .....	6	<b>V</b>	
General.....	5	Validity.....	2
Safety warnings		<b>W</b>	
Appliance-specific .....	5	Warranty extensions.....	51
Saving energy.....	30, 45	Wire shelf.....	12
Self-cleaning .....	38		
Cancelling .....	39		

# 17 Notes



## 18 Service & Support



The «Trouble-shooting» section gives you valuable tips on how to deal with minor malfunctions yourself, saving you the time and trouble of calling out a service technician and any cost that goes along with it.

Information on the V-ZUG warranty can be found at [www.vzug.com](http://www.vzug.com) →Service →Warranty information. Please read this information carefully.

Please register your appliance straightaway online at [www.vzug.com](http://www.vzug.com) →Service →Warranty registration. This will allow you to take advantage of the best possible support in the event of a fault in the appliance during the guarantee period. You will require the serial number (SN) and appliance designation to register your appliance. You will find them on the identification plate of your appliance.

My appliance information:

**SN:** \_\_\_\_\_ **Appliance:** \_\_\_\_\_

Please have this appliance information to hand when contacting V-ZUG. Thank you.

- ▶ Open the appliance door.
  - The identification plate is located on the left-side panel.

### Your repair order

At [www.vzug.com](http://www.vzug.com) →Service→Service number you will find the telephone number of your nearest V-ZUG service centre.

### Technical questions, accessories, warranty extensions

V-ZUG is happy to help you with any general administrative or technical queries, to take your orders for accessories and spare parts and to inform you about our progressive service agreements.

# Quick instructions

Here you will find an overview of key operating information.

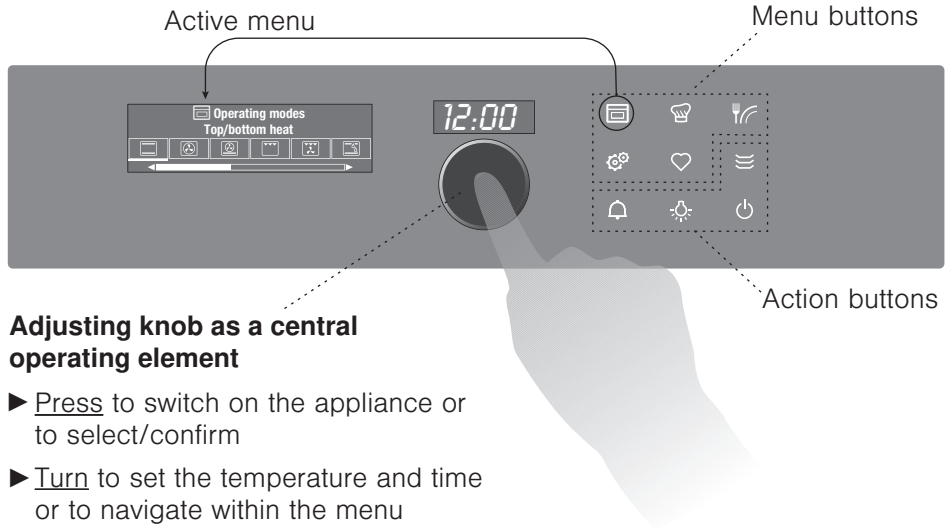



## Adjusting knob as a central operating element

- ▶ Press to switch on the appliance or to select/confirm
- ▶ Turn to set the temperature and time or to navigate within the menu

## Menu and action buttons

The menu buttons contain a selection of preparation options and user settings. These can be selected by pressing the relevant button. The active menu is shown in the display. You can use the adjusting knob to operate and navigate within the menu; additional submenus can also be called up.

The function buttons give you direct access to independent functions such as the timer  or switching off the appliance .



J21015352-R09

