



Canon

IXUS 310 HS

Camera User Guide

- Make sure you read this guide, including the “Safety Precautions” section, before using the camera.
- Reading this guide will help you learn to use the camera properly.
- Store this guide safely so that you can use it in the future.

ENGLISH

Checking the Package Contents

Check if the following items are included in your camera package.
If anything is missing, contact the retailer where you purchased the camera.



Camera

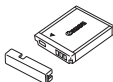

**Battery Pack NB-6L
(with Terminal Cover)**



**Battery Charger
CB-2LY/CB-2LYE**

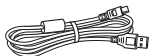

**Interface Cable
IFC-400PCU**

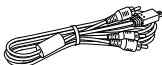

**Stereo AV Cable
AVC-DC400ST**



**Wrist Strap
WS-DC10**



Getting Started



**DIGITAL CAMERA
Solution Disk**



**Warranty System
Booklet**

Using the Manuals

Also refer to the manuals on the DIGITAL CAMERA Manuals Disk.

- **Camera User Guide (This Guide)**
Once you have mastered the basics, use the camera's many features to shoot more challenging photos.
- **Software Guide**
Read when you want to use the included software.



- A memory card is not included.
- Adobe Reader is required to view the PDF manuals. Microsoft Word/Word Viewer can be installed to view the Word manuals (required only for manuals for the Middle East).

Read This First

Test Shots and Disclaimer

Take some initial test shots and play them back to make sure the images were recorded correctly. Please note that Canon Inc., its subsidiaries and affiliates, and its distributors are not liable for any consequential damages arising from any malfunction of a camera or accessory, including memory cards, that results in the failure of an image to be recorded or to be recorded in a way that is machine readable.

Warning Against Copyright Infringement

The images recorded with this camera are intended for personal use. Do not record images that infringe upon copyright laws without the prior permission of the copyright holder. Please be advised that in certain cases the copying of images from performances, exhibitions, or commercial properties by means of a camera or other device may contravene copyright or other legal rights even if the image was shot for personal use.

Warranty Limitations

For information on your camera's warranty, please refer to the Canon Warranty System Booklet supplied with your camera.

For Canon Customer Support contacts, please see the Warranty System Booklet.

LCD Monitor (Screen)

- The LCD monitor is produced with extremely high-precision manufacturing techniques. More than 99.99% of the pixels operate to specification, but occasionally non-performing pixels may appear as bright or dark dots. This is not a malfunction and has no effect on the recorded image.
- The LCD monitor may be covered with a thin plastic film for protection against scratches during shipment. If so, remove the film before using the camera.

Camera Body Temperature

Please take care when operating the camera for an extended period as the camera body may become warm. This is not a malfunction.

What Do You Want to Do?

Shoot



- Shoot, leaving it to the camera to make settings25

Take good people shots



Portraits
(p. 64)



Kids and pets
(p. 65)



Facial expressions
(p. 81)



At the beach
(p. 65)



Against snow
(p. 66)

Shoot various other scenes



Night Scene
(p. 65)



Low Light
(p. 65)



Foliage
(p. 65)



Fireworks
(p. 66)

Shoot with special effects



Fish-eye Effect
(p. 69)



Miniature Effect
(p. 70)



Toy Camera Effect
(p. 75)



Creative Light Effect
(p. 71)



Monochrome
(p. 74)



Super vivid colors
(p. 68)



Poster Effect
(p. 68)

- Focus on faces25, 64, 95
- Shoot in places where I cannot use the flash
(turn off the flash) 54
- Take pictures with me in them too (self-timer) 58, 59, 78
- Insert the date and time into my shots57
- Take a picture while shooting a movie 67

View

- Look at my pictures 28
- Automatically play back pictures (slideshow) 124
- Look at my pictures on a TV 133
- Look at my pictures on a computer 34
- Quickly search pictures 120
- Erase pictures 30, 139

**Shoot/View Movies**

- Shoot movies 31, 111
- View movies 33
- Shoot fast moving subjects and play them back
in slow motion 114

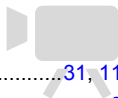
**Print**

- Easily print pictures 152

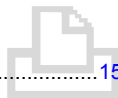
**Save**

- Save images to a computer 34

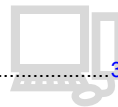
**Other**

- Turn off sounds 49
- Use the camera abroad 16, 169
- Understand what is displayed on the screen 187

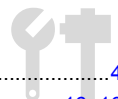

Table of Contents

Chapters 1 – 3 explain the basic operations and frequently used functions of this camera. Chapters 4 onward explain the advanced functions, letting you learn more as you read each chapter.

Checking the Package Contents	2
Read This First	3
What Do You Want to Do?	4
Table of Contents	6
Conventions Used in This Guide	9
Safety Precautions.....	10

1 Getting Started..... 13

Using the Touch Panel	14
Charging the Battery.....	15
Compatible Memory Cards (Sold Separately).....	17
Inserting the Battery and Memory Card.....	17
Setting the Date and Time	20
Setting the Display Language.....	22
Formatting Memory Cards	23
Pressing the Shutter Button.....	24
Taking Pictures (Smart Auto).....	25
Viewing Images	28
Active Display	29
Erasing Images.....	30
Shooting Movies	31
Viewing Movies.....	33
Transferring Images to a Computer for Viewing	34
Accessories	38
Separately Sold Accessories	39

2 Learning More..... 41

Components Guide.....	42
Screen Display.....	44
Indicator	45

FUNC. Menu – Basic Operations....	46
MENU – Basic Operations	47
Changing the Sound Settings	49
Adjusting the Screen Brightness	50
Returning the Camera to Default Settings	51
Power Saving Function (Auto Power Down).....	52

3 Shooting with Commonly Used Functions53

Turning the Flash Off	54
Zooming in More Closely on Subjects (Digital Zoom).....	55
Inserting the Date and Time.....	57
Using the Self-Timer	58
Changing the Recording Pixel Setting (Image Size)	60
Changing the Compression Ratio (Image Quality)	60

4 Adding Effects and Shooting in Various Conditions.....63

Shooting in Various Conditions	64
Making Short Movies Automatically (Movie Digest).....	67
Adding Effects and Shooting.....	68
Detecting a Face and Shooting (Smart Shutter)	76
High-Speed Continuous Shooting (High-speed Burst).....	80
Capturing the Best Facial Expressions (Best Image Selection).....	81

5 Choosing Settings Yourself.....83

Shooting in Program AE	84
Adjusting the Brightness (Exposure Compensation)	85
Turning the Flash On	85
Adjusting the White Balance	86
Changing the ISO Speed	88
Correcting the Brightness and Shooting (i-Contrast)	89
Changing the Aspect Ratio	90
Continuous Shooting.....	91
Changing the Tone of an Image (My Colors)	92
Shooting Close-ups (Macro)	94
Shooting Far Away Subjects (Infinity)	94
Changing the AF Frame Mode.....	95
Magnifying the Focal Point.....	97
Choosing the Subject to Focus On (Touch AF)	98
Shooting with the AF Lock	99
Shooting with Servo AF	100
Changing the Metering Method.....	101
Shooting with the AE Lock	102
Shooting with the FE Lock	102
Shooting with Slow Synchro	103
Red-Eye Correction	104
Checking for Shut Eyes	105

6 Getting More Out of Your Camera.....107

Setting the Shutter Speed.....	108
Setting the Aperture Value.....	109

7 Using Various Functions for Shooting Movies..... 111

Shooting Various Kinds of Movies.....	112
Shoot Movies That Look Like a Miniature Model (Miniature Effect).....	113
Shooting Super Slow Motion Movies.....	114
Changing the Image Quality.....	116
Other Shooting Functions.....	117
Editing	117

8 Using Various Playback and Editing Functions..... 119

Quickly Searching Images.....	120
Viewing Images in Filtered Playback.....	123
Viewing Slideshows.....	124
Checking the Focus.....	126
Magnifying Images	127
Viewing Each Image in a Group....	128
Displaying Various Images (Smart Shuffle)	130
Changing Image Transitions	131
Easy Operations with Touch Actions	131
Viewing Images on a TV	133
Protecting Images	137
Erasing All Images	139
Tagging Images as Favorites.....	141
Organizing Images by Category (My Category)	143
Rotating Images	144
Resizing Images.....	145
Trimming	146

Adding Effects with the My Colors Function.....	148
---	-----

Correcting the Brightness (i-Contrast).....	149
Correcting the Red-Eye Effect.....	150

9 Printing 151

Printing Images.....	152
Choosing Images for Printing (DPOF).....	159

10 Customizing Camera Settings 163

Changing Camera Settings.....	164
Changing Shooting Function Settings.....	171
Changing Playback Function Settings.....	176

11 Useful Information 177

Using Household Power.....	178
Using an Eye-Fi Card.....	179
Troubleshooting	181
List of Messages That Appear on the Screen.....	184
Information Displayed on the Screen.....	187
Handling Precautions.....	191
Functions Available in Each Shooting Mode.....	192
Menus	196
Playback Mode FUNC. Menu.....	200
Specifications	201
Index	205

Conventions Used in This Guide

- Icons are used in the text to represent the camera buttons and switches.
- Language that displays on the screen appears inside [] (square brackets).
- ① : Things you should be careful about
- ? : Troubleshooting tips
- ? : Hints for getting more out of your camera
- ? : Supplemental information
- (p. xx): Reference pages (“xx” stands for a page number)
- This guide assumes all functions are at their default settings.
- The various types of memory cards that can be used in this camera are collectively referred to as memory cards in this guide.

Safety Precautions

- Before using the product, please ensure that you read the safety precautions described below. Always ensure that the product is used correctly.
- The safety precautions noted on the following pages are intended to prevent injuries to yourself and other persons, or damage to the equipment.
- Be sure to also check the guides included with any separately sold accessories you use.



Warning

Denotes the possibility of serious injury or death.

- **Do not trigger the flash in close proximity to people's eyes.**

Exposure to the intense light produced by the flash could damage eyesight. In particular, remain at least one meter (39 inches) away from infants when using the flash.

- **Store this equipment out of the reach of children and infants.**

Strap: Putting the strap around a child's neck could result in asphyxiation.

- **Use only recommended power sources.**
- **Do not attempt to disassemble, alter or apply heat to the product.**
- **Avoid dropping or subjecting the product to severe impacts.**
- **To avoid the risk of injury, do not touch the interior of the product if it has been dropped or otherwise damaged.**
- **Stop using the product immediately if it emits smoke, a strange smell, or otherwise behaves abnormally.**
- **Do not use organic solvents such as alcohol, benzene, or thinner to clean the equipment.**
- **Do not let the product come into contact with water (e.g. sea water) or other liquids.**
- **Do not allow liquids or foreign objects to enter the camera.**

This could result in electrical shock or fire.

If liquids or foreign objects come into contact with the camera interior, immediately turn the camera power off and remove the battery.

If the battery charger becomes wet, unplug it from the outlet and consult your camera distributor or a Canon Customer Support Help Desk.

- **Use only the recommended battery.**
- **Do not place the battery near or in direct flame.**
- **Unplug the power cord periodically, and using a dry cloth, wipe away any dust and dirt that has collected on the plug, the exterior of the power outlet, and the surrounding area.**
- **Do not handle the power cord with wet hands.**
- **Do not use the equipment in a manner that exceeds the rated capacity of the electrical outlet or wiring accessories. Do not use if the power cord or plug are damaged, or not fully plugged into the outlet.**
- **Do not allow dirt or metal objects (such as pins or keys) to contact the terminals or plug.**

The battery may explode or leak, resulting in electrical shock or fire. This could cause injury and damage the surroundings. In the event that a battery leaks and the battery acid contacts eyes, mouth, skin or clothing, immediately flush with water.

- **Turn the camera off in places where camera use is prohibited.**

The electromagnetic waves emitted by the camera may interfere with the operation of electronic instruments and other devices. Exercise adequate caution when using the camera in places where use of electronic devices is restricted, such as inside airplanes and medical facilities.

- **Do not play the supplied CD-ROM(s) in any CD player that does not support data CD-ROMs.**

It is possible to suffer hearing loss from listening with headphones to the loud sounds of a CD-ROM played on a music CD player. Additionally, playing the CD-ROM(s) in an audio CD player (music player) could damage the speakers.



Caution

Denotes the possibility of injury.

- **Be careful not to bang the camera or subject it to strong impacts or shocks when hanging it by the strap.**
- **Be careful not to bump or push strongly on the lens.**

This could lead to injury or damage the camera.

- **When using the flash, be careful not to cover it with your fingers or clothing.**

This could result in burns or damage to the flash.

- **Avoid using, placing or storing the product in the following places:**
 - Places subject to strong sunlight
 - Places subject to temperatures above 40 °C (104 °F)
 - Humid or dusty areas

These could cause leakage, overheating or an explosion of the battery, resulting in electrical shock, fire, burns or other injuries.

High temperatures may cause deformation of the camera or battery charger casing.

- **The slideshow transition effects may cause discomfort when viewed for prolonged periods.**

Caution

Denotes the possibility of damage to the equipment.

- **Do not aim the camera at bright light sources (such as the sun on a clear day).** Doing so may damage the image sensor.

- **When using the camera on a beach or at a windy location, be careful not to allow dust or sand to enter the camera.**

This may cause the product to malfunction.

- **In regular use, small amounts of smoke may be emitted from the flash.**

This is due to the high intensity of the flash burning dust and foreign materials stuck to the front of the unit. Please use a cotton swab to remove dirt, dust or other foreign matter from the flash to prevent heat build-up and damage to the unit.

Safety Precautions

- **Remove and store the battery when you are not using the camera.**

If the battery is left inside the camera, damage caused by leakage may occur.

- **Before you discard the battery, cover the terminals with tape or other insulators.**

Contacting other metal materials may lead to fire or explosions.

- **Unplug the battery charger from the power outlet after charging is complete, or when you are not using it.**
- **Do not place anything, such as cloth on top of the battery charger while it is charging.**

Leaving the unit plugged in for a long period of time may cause it to overheat and distort, resulting in fire.

- **Do not place the battery near pets.**

Pets biting the battery could cause leakage, overheating or explosion, resulting in fire or damage.

- **Do not sit down with the camera in your pocket.**

Doing so may cause malfunctions or damage the screen.

- **When putting the camera in your bag, ensure that hard objects do not come into contact with the screen.**

- **Do not attach any hard objects to the camera.**

Doing so may cause malfunctions or damage the screen.



Getting Started

This chapter explains preparations before shooting, how to shoot in **AUTO** mode, and then how to view and erase the images you take. The latter part of this chapter explains how to shoot and view movies and transfer images to a computer.

Attaching the Strap/Holding the Camera

- Attach the included strap and wrap it around your wrist to avoid dropping the camera during use.
- Keep your arms tight against your body while holding the camera firmly by the sides when shooting. Be sure that your fingers do not block the flash or touch the screen.

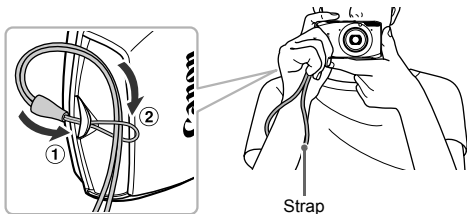

Using the Touch Panel

This camera has a touch panel screen that allows you to perform operations with the touch of your finger.

Touch



Briefly touch the screen with your finger.

- Used for choosing icons or magnifying images.

Drag



Touch and drag your finger across the screen.

- Used for playback operations such as switching to the next image, or moving the displayed location of magnified images.



Since the camera uses a pressure sensitive touch panel, the camera may not recognize touch operations if you install a screen protector.



What if I cannot perform operations well?

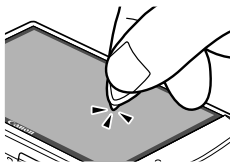

When touching with your finger does not work well, you can use the toggle attached to the strap to perform operations. Only use the attached toggle to perform operations. Do not use other objects, such as pens or pencils.

You can calibrate the touch panel if you are having difficulty choosing items or buttons ([p. 170](#)).

Charging the Battery

Use the included charger to charge the battery. Be sure to charge the battery as it is not charged at the time of purchase.

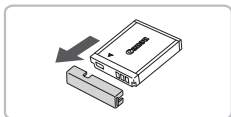

1 Remove the cover.

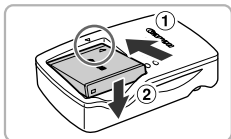

2 Insert the battery.

- Align the ▲ marks on the battery and charger, then insert the battery by sliding it in (1) and down (2).

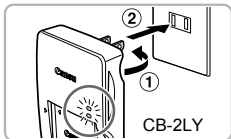

3 Charge the battery.

- For **CB-2LY**: Flip out the plug (1) and plug the charger into a power outlet (2).
- For **CB-2LYE**: Plug the power cord into the charger, then plug the other end into a power outlet.
- ▶ The charge lamp lights red and charging starts.
- ▶ The charge lamp will light green when charging has finished. Charging takes approx. 1 hour and 55 minutes.

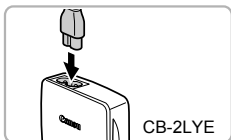

4 Remove the battery.

- Unplug the battery charger from the power outlet, then remove the battery by sliding it in (1) and up (2).



To protect the battery and prolong its life, do not charge it for longer than 24 hours continuously.



Number of Possible Shots

Number of Shots	Approx. 180
Playback Time	Approx. 4 hours

- The number of shots that can be taken is based on the Camera & Imaging Products Association (CIPA) measurement standard.
- Under some shooting conditions, the number of shots that can be taken may be less than mentioned above.

Battery Charge Indicator

An icon or message will appear on the screen indicating the battery's charge state.

Display	Summary
	Sufficient charge.
	Slightly depleted, but sufficient.
 (Blinking red)	Nearly depleted. Charge the battery.
"Change the battery pack."	Depleted. Recharge the battery.



Using the battery and charger effectively

- Charge the battery on the day, or the day before, it will be used.
Charged batteries continue to discharge naturally even if they are not used.

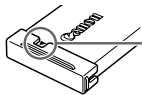

Attach the cover to a charged battery so that the ▲ mark is visible.

- How to store the battery for long periods:
Deplete and remove the battery from the camera. Attach the terminal cover and store the battery. Storing a battery for long periods of time (about a year) without depleting it may shorten its life span or affect its performance.
- The battery charger can also be used when abroad.
The charger can be used in regions that have 100 – 240 V (50/60 Hz) AC power. If the plug does not fit the outlet, use a commercially available plug adapter. Do not use electrical transformers for foreign travel as they will cause damage.
- The battery may develop a bulge.
This is a normal characteristic of the battery and does not indicate a problem. However, if the battery bulges to the point where it will no longer fit into the camera, please contact a Canon Customer Support Help Desk.
- If the battery is quickly depleted even after charging, it has reached the end of its life span. Purchase a new battery.

Compatible Memory Cards (Sold Separately)

The cards below can be used without restrictions on their capacities.

- SD memory cards*
- SDHC memory cards*
- SDXC memory cards *
- MultiMediaCards
- MMC*plus* memory cards
- HC MMC*plus* memory cards
- Eye-Fi Cards

* This memory card complies with the SD standards. Some cards may not operate properly depending on the brand of card used.



Depending on your computer's OS version, SDXC memory cards may not be recognized even when using a commercially available card reader. Check to make sure that your OS supports SDXC memory cards beforehand.

About Eye-Fi Cards

This product is not guaranteed to support Eye-Fi card functions (including wireless transfer). In case of an issue with an Eye-Fi card, please check with the card manufacturer.

Also note that an approval is required to use Eye-Fi cards in many countries or regions. Without approval, use of the card is not permitted. If it is unclear whether the card has been approved for use in the area, please check with the card manufacturer.

Inserting the Battery and Memory Card

Insert the included battery and a memory card (sold separately).

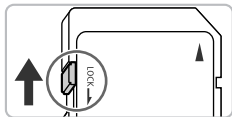

1 Check the card's write-protect tab.

- If the memory card has a write-protect tab, you will not be able to record images if the tab is in the locked position. Slide the tab up until you hear a click.

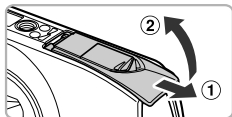

2 Open the cover.

- Slide the cover (①) and open it (②).

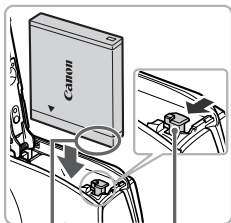

Terminals

Battery lock

3 Insert the battery.

- Press the battery lock in the direction of the arrow, then insert the battery as shown until it locks into place with a click.
- Be sure to insert the battery in the correct direction or it will not properly lock into place.

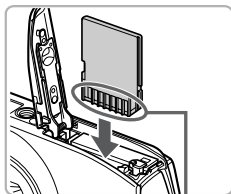

Terminals

4 Insert the memory card.

- Insert the memory card as shown until it locks into place with a click.
- Be sure the memory card is oriented correctly. Inserting the memory card in the wrong direction could damage the camera.

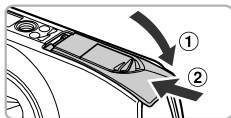

5 Close the cover.

- Close the cover (①), and press downward as you slide it until it clicks into place (②).



What if [Memory card locked] appears on the screen?

SD, SDHC, SDXC memory cards, and Eye-Fi cards have a write-protect tab. If this tab is in the locked position, [Memory card locked] will appear on the screen and you will not be able to take or erase images.

Removing the Battery and Memory Card

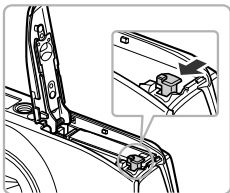

Remove the battery.

- Open the cover and press the battery lock in the direction of the arrow.
- ▶ The battery will pop up.

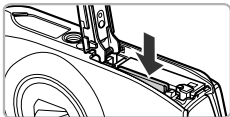

Remove the memory card.

- Push the memory card in until you hear a click, then slowly release it.
- ▶ The memory card will pop up.

Number of Shots per Memory Card

Memory Card	4 GB	16 GB
Number of Shots	Approx. 1231	Approx. 5042

- Values are based on the default settings.
- The number of shots that can be taken will vary depending on camera settings, the subject and the memory card used.



Can you check the number of shots that can be taken?

You can check the number of shots that can be taken when the camera is in a Shooting mode (p. 25).

Number of shots that can be taken



Setting the Date and Time

The Date/Time settings screen will appear the first time the camera is turned on. Since the dates and times recorded into your images are based on these settings, be sure to set them.

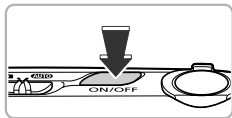

1 Turn on the camera.

- Press the ON/OFF button.
- ▶ The Date/Time screen will appear.

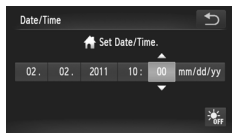

2 Set the date and time.

- Touch the option you want to set.
- ▶ ▲▼ will appear.
- Touch ▲▼ to set a value.

3 Complete the setting.

- Touch ↻.
- ▶ Once the date and time have been set, the Date/Time screen will close.
- Pressing the ON/OFF button will turn off the camera.

? Reappearing Date/Time screen

Set the correct date and time. If you have not set the date and time, the Date/Time screen will appear each time you turn on the camera.

💡 Daylight saving time settings

If you touch ☀_{OFF} in Step 2 and then choose ☀, you will set the time to daylight saving (1 hour ahead).

Changing the Date and Time

You can change the current date and time settings.



1 Display the menu.

- After touching **FUNC.**, touch **MENU**.

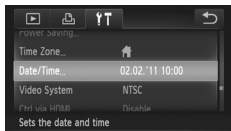

2 Choose [Date/Time].

- Touch the **YT** tab.
- Drag up or down the screen to choose [Date/Time].
- Touch [Date/Time].

3 Change the date and time.

- Follow Steps 2 and 3 on [p. 20](#) to adjust the setting.
- Touch **↶** twice to close the menu.



Date/Time battery

- The camera has a built-in date/time battery (backup battery) that allows the date/time settings to be retained for about three weeks after the battery pack has been removed.
- By inserting a charged battery or connecting an AC adapter kit (sold separately, [p. 39](#)) the date/time battery can be charged in about 4 hours even if the camera is not turned on.
- If the date/time battery is depleted, the Date/Time screen will appear when you turn the camera on. Follow the steps on [p. 20](#) to set the date and time.

Setting the Display Language

You can change the language that displays on the screen.



1 Enter Playback mode.

- Press the button.

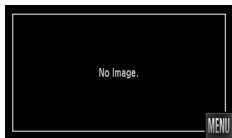

2 Display the settings screen.

- Touch and hold **MENU**.
- ▶ The settings screen will appear.



3 Set the display language.

- Touch a display language, then touch .
- ▶ Once the display language has been set, the settings screen will close.



What if MENU does not appear?

When there are images on the memory card, touch **FUNC.** on the lower left of the screen to display **MENU**.



You can also change the display language by touching **FUNC.**, then **MENU**. Choose the tab in the screen that appears, then choose the [Language] menu item.

Formatting Memory Cards

Before you use a new memory card or one that has been formatted in other devices, you should format the card with this camera. Formatting (initializing) a memory card erases all data on the memory card. As you cannot retrieve the erased data, exercise adequate caution before formatting the memory card. Before formatting an Eye-Fi card (p. 179), be sure to install the software contained on the card to a computer.



1 Display the menu.

- Touch **FUNC.**, then touch **MENU**.

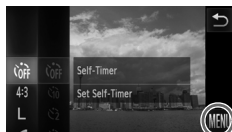

2 Choose [Format].

- Touch the **YT** tab.
- Drag up or down the screen to choose **[Format]**.
- Touch **[Format]**.

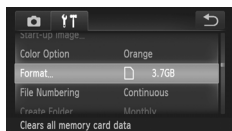

3 Choose [OK].

- Touch **[OK]**.
- ▶ A confirmation screen will appear.



4 Format the memory card.

- Touch **[OK]**.
- ▶ The memory card will be formatted.

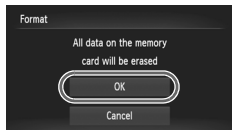

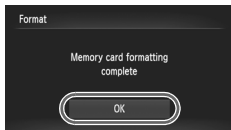

5 Complete formatting.

- ▶ When formatting ends, [Memory card formatting complete] will appear on the screen.
- Touch [OK].



Formatting or erasing data on a memory card merely changes the file management information on the card and does not ensure its contents are completely erased. Be careful when transferring or disposing of a memory card. When disposing of a memory card, take precautions such as physically destroying the card to prevent personal information leaks.



- The total capacity of the memory card displayed in the formatting screen may be less than indicated on the memory card.
- Perform a low-level format (p. 165) of the memory card when the camera does not operate properly, the recording/reading speed of a memory card has dropped, when continuous shooting speed slows down, or when movie recording stops suddenly.

Pressing the Shutter Button

To take images that are in focus, be sure to first press the shutter button lightly (halfway) to focus, then press fully to shoot.

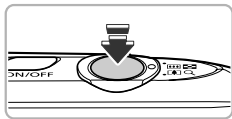

1 Press halfway (Press lightly to focus).

- Press lightly until the camera beeps twice and AF frames appear where the camera focused.

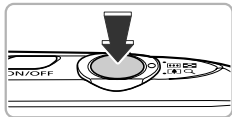

2 Press fully (Press fully to shoot).

- ▶ The camera plays the shutter sound and takes the shot.
- Since the shot is being taken while the shutter sound plays, be careful not to move the camera.

? Does the length of the shutter sound change?

- Since the time required to shoot differs depending on the scene you want to take, the length of the shutter sound may change.
- If the camera or subject moves while the shutter sound is playing, the recorded image may be blurry.



If you shoot without pressing the shutter button halfway, the image may not be in focus.

Taking Pictures (Smart Auto)

Since the camera can determine the subject and shooting conditions, you can let it automatically select the best settings for the scene and just shoot. The camera can also detect and focus on faces, setting the color and brightness to optimal levels.

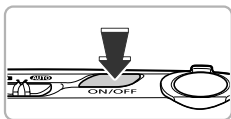

1 Turn on the camera.

- Press the ON/OFF button.
- ▶ The start-up screen will appear.

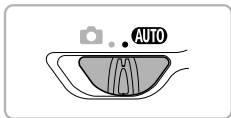

2 Enter **AUTO** mode.

- Set the mode switch to **AUTO**.
- When you point the camera toward the subject, the camera will make a slight noise as it determines the scene.
- ▶ The icon for the determined scene will appear in the upper left of the screen.
- ▶ The camera will focus on detected subjects and display frames on them.
- ▶ Black bars will appear on the sides of the screen. These areas will not be recorded when shooting.



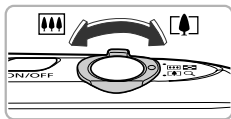



Zoom bar



3 Compose the shot.

- Moving the zoom lever toward  (telephoto) will zoom in on your subject, making it appear larger. Moving the lever toward  (wide angle) will zoom out from your subject, making it appear smaller. (The zoom bar showing the zoom position appears on the screen.)

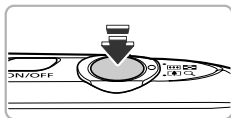

4 Focus.

- Press the shutter button halfway to focus.



AF Frame

- ▶ When the camera focuses, it will beep twice and AF frames will appear where the camera focused. Several AF frames will appear when the camera focuses on more than one point.

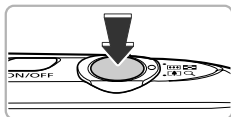

5 Shoot.

- Press the shutter button fully to shoot.
- ▶ The camera will play the shutter sound and shoot. The flash will automatically fire in low light conditions.
- ▶ The image will appear on the screen for approximately two seconds.
- You can take a second picture even while an image is displayed by pressing the shutter button again.

? What if...







- What if the color and brightness of the images do not turn out as expected?

The scene icon (p. 188) that appears on the screen may not match the actual scene. If this happens, try shooting in **P** mode (p. 83).

- **What if white and gray frames appear when you point the camera toward a subject?**

A white frame appears on the face or subject that the camera detected as the main subject, while gray frames appear on other detected faces. The frames will follow the subjects within a certain range.

If the subject moves, however, the gray frames will disappear, leaving only the white frame.

- **What if a frame does not appear on the subject you want to shoot?**
The subject may not be detected, and frames may appear on the background. If this happens, try shooting in **P** mode (p. 83).
- **What if a blue frame appears when you press the shutter button halfway?**
A blue frame appears when a moving subject is detected; the focus and exposure will continuously adjust (Servo AF).
- **What if a flashing  appears?**
Attach the camera to a tripod so that the camera does not move and blur the image.
- **What if the image comes out dark even if the flash fired when shooting?**
The subject is too far away for the flash to reach. The effective flash range is approximately 50 cm – 5.0 m (1.6 – 16 ft.) at maximum wide angle () and approximately 50 cm – 2.0 m (1.6 – 6.6 ft.) at maximum telephoto ()
- **What if the camera beeps once when the shutter button is pressed halfway?**
Your subject may be too close. When the camera is at maximum wide angle () , move about 3 cm (1.2 in.) or more away from your subject and shoot. Move about 40 cm (1.3 ft.) or more away when the camera is at maximum telephoto ()
- **What if the lamp lights when the shutter button is pressed halfway?**
To reduce red-eye and to assist in focusing, the lamp may light when shooting in dark areas.
- **What if the  icon blinks when you try to shoot?**
The flash is charging. You can shoot when recharging ends.
- **What if **ND** appears when the shutter button is pressed halfway?**
When you press the shutter button halfway in extremely bright shooting conditions, **ND** will appear and the brightness will automatically adjust to appropriate levels.



What if an icon appears in the upper left of the screen?

The icon for the determined scene will appear in the upper left of the screen. For details on the icons that appear, see “Scene Icons” (p. 188).



Choosing the subject to focus on (Touch AF)

After touching the subject and displaying , the focus and exposure will be maintained where the blue AF frame appears when you press the shutter button halfway (Servo AF). Press the shutter button fully to shoot.

Viewing Images

You can view the images you have taken on the screen.





1 Enter Playback mode.

- Press the  button.
- ▶ The last image you took will appear.



2 Choose an image.

- Dragging left to right across the screen will cycle through the images in the reverse order they were taken, from the newest image to the oldest.
- Dragging right to left across the screen will cycle through images in the order they were taken, from oldest to newest.
- If you touch the left edge of the screen (inside frame ① on the screen at the left),  will appear and images will display in the reverse order they were taken, from the newest image to the oldest.
- If you touch the right edge of the screen (inside frame ② on the screen at the left),  will appear and images will display in the order they were taken, from oldest to newest.
- The images change more quickly if you touch and hold .
- The lens will retract after approximately 1 minute elapses.



- Pressing the  button again while the lens is retracted will turn off the power.



Switching to Shooting mode

Pressing the shutter button halfway while in Playback mode switches the camera to Shooting mode.

Active Display

When an image is displayed, lightly tapping the camera as shown below will switch to the next image.



- Be sure to put the strap around your wrist, and hold the camera firmly to avoid dropping it.
- Depending on the way you tap the camera, images may not switch.

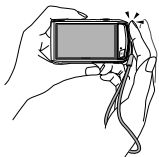

Switch to next image

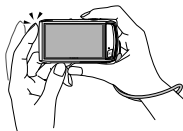



Switch to previous image



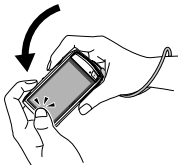

Tilt the camera to switch images



If you touch and hold  on the left of the screen and tilt the camera as shown while switching through images (p. 28), the images advance quickly. Tilt the camera in the opposite direction while holding .



While dragging an image, if you touch and hold  or  the image will appear coarse.

Erasing Images

You can choose and erase images one at a time. Please note that erased images cannot be recovered. Exercise adequate caution before erasing an image.



1 Enter Playback mode.

- Press the  button.
- ▶ The last image you took will appear.



2 Choose an image to erase.

- Drag across the screen to choose an image.



3 Erase the image.

- After touching **FUNC.**, drag up or down the screen to choose , then touch the menu item again.
- ▶ [Erase?] appears on the screen.

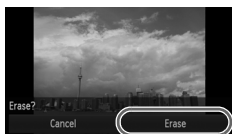
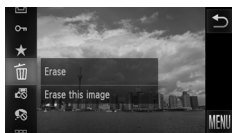

- Touch [Erase].
- ▶ The displayed image will be erased.
- To exit instead of erasing, touch [Cancel].



You can also use Touch Actions to erase images ([p. 131](#)).

Shooting Movies

The camera will determine the subject and shooting conditions, and select the best settings for the scene. The audio will record in stereo.

If you continue shooting for a long time, the camera may become warm. This is not a malfunction.



1 Choose **AUTO** mode.

- Set the mode switch to **AUTO**.

Remaining Time

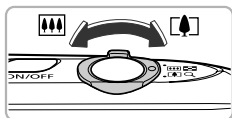

2 Compose the shot.

- Moving the zoom lever toward [🌲] will zoom in on your subject, making it appear larger. Moving the lever toward [🌲🌲🌲] will zoom out from your subject, making it appear smaller.



Elapsed Time



3 Shoot.

- Touch ● .
- ▶ The camera will beep once, recording will start, and [●Rec] and the elapsed time will appear on the screen.
- If you change the composition of your shot during shooting, the focus, brightness and tone will automatically adjust.

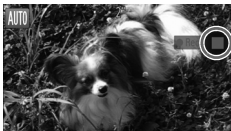
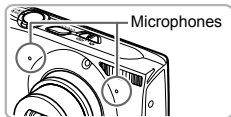

- Do not touch the microphones while shooting.
- Do not operate the camera other than touching **●** while shooting. Operation sounds will be recorded in the movie.

4 Stop shooting.

- Touch **■**.
- ▶ The camera will beep twice and stop shooting the movie.
- ▶ The movie will record to the memory card.
- ▶ Shooting will automatically stop when the memory card fills.



Zooming while shooting

Pressing the zoom lever while shooting will zoom in or out from the subject. However, operation sounds will be recorded.



- When the mode switch is set to **AUTO**, the icon for the determined scene will appear (p. 188). “When Moving” icons will not appear, however. Under certain conditions, the icon that appears may not match the actual scene.
- If you change the composition while shooting and the white balance is not optimal, touch **■** to stop recording, then start recording again (only when the image quality is set to **Fi920** (p. 116)).
- Movies can be shot by touching **●** even if the mode switch is set to **📷** (p. 111).

Shooting Time

Memory Card	4 GB	16 GB
Shooting Time	Approx. 14 min. 34 sec.	Approx. 59 min. 40 sec.



- Shooting times are based on default settings.
- Maximum clip length is approx. 10 minutes.
- Recording may stop even if the maximum clip length has not been reached on some memory cards. SD Speed Class 6 or higher memory cards are recommended.

Viewing Movies

You can view the movies you have shot on the screen.



1 Enter Playback mode.

- Press the  button.
- ▶  appears on movies.





2 Choose a movie.

- Drag across the screen to choose a movie to play back.



3 Play the movie.

- Touch .
- ▶ The movie will play.
- If you touch the screen during playback, the movie will stop, and the movie control panel will appear on the screen.
- Drag up or down the screen during playback to adjust the volume.
- ▶ After the movie finishes,  appears.

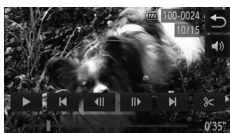

? How can I play back movies on a computer?

Install the included software (p. 35).

- When watching a movie on a computer, frames may drop, it may not play smoothly, and the audio may stop suddenly depending on the computer's capabilities.
- If you use the supplied software to copy the movie back onto the memory card, you can play back the movie smoothly with the camera. For enhanced playback you can also connect the camera to a TV.

Transferring Images to a Computer for Viewing

You can use the included software to transfer images you have shot with the camera to a computer for viewing. If you are already using software included with another Canon-brand compact digital camera, install the software from the included CD-ROM, overwriting your current installation.

System Requirements

Windows

OS	Windows 7 Windows Vista Service Pack 1 and 2 Windows XP Service Pack 3
Computer model	The above OS should be pre-installed on computers with built-in USB ports.
CPU	Pentium 1.3 GHz or higher (still images), Core 2 Duo 2.6 GHz or higher (movies)
RAM	Windows 7 (64 bit): 2 GB or more Windows 7 (32 bit), Windows Vista (64 bit, 32 bit): 1 GB or more (still images), 2 GB or more (movies) Windows XP: 512 MB or more (still images), 2 GB or more (movies)
Interface	USB
Free Hard Disk Space	ZoomBrowser EX: 200 MB or more CameraWindow: 150 MB or more* Movie Uploader for YouTube: 30 MB or more PhotoStitch: 40 MB or more
Display	1,024 x 768 pixels or higher

* For Windows XP, Microsoft .NET Framework 3.0 or later (max. 500 MB) must be installed. Installation may take some time depending on your computer's capabilities.

Macintosh

OS	Mac OS X (v10.5 – v10.6)
Computer model	The above OS should be pre-installed on computers with built-in USB ports.
CPU	Intel Processor (still images), Core 2 Duo 2.6 GHz or higher (movies)
RAM	Mac OS X v10.6: 1 GB or more (still images), 2 GB or more (movies) Mac OS X v10.5: 512 MB or more (still images), 2 GB or more (movies)
Interface	USB
Free Hard Disk Space	ImageBrowser: 250 MB or more CameraWindow: 150 MB or more Movie Uploader for YouTube: 30 MB or more PhotoStitch: 50 MB or more
Display	1,024 x 768 pixels or higher

Preparations

Windows Vista and Mac OS X (v10.5) are used for these explanations.

1 Install the Software.

Windows

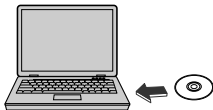

① Place the CD in the computer's CD-ROM drive.

- Place the supplied CD-ROM (DIGITAL CAMERA Solution Disk) (p. 2) into the computer's CD-ROM drive.



② Begin installation.

- Click [Easy Installation] and follow the on-screen instructions to proceed with the installation.
- If the [User Account Control] window appears, follow the on-screen instructions to proceed.



③ When the installation finishes, click [Restart] or [Finish].

④ Remove the CD-ROM.

- Remove the CD-ROM when your desktop screen appears.

Macintosh

① Place the CD in the computer's CD-ROM drive.

- Place the supplied CD-ROM (DIGITAL CAMERA Solution Disk) (p. 2) into the computer's CD-ROM drive.



② Begin installation.

- Double-click the  on the CD.
- Click [Install], and follow the on-screen instructions to proceed with the installation.

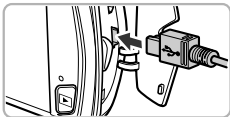

2 Connect the camera to the computer.

- Turn off the camera.
- Open the cover and insert the included interface cable's smaller plug (p. 2) firmly into the camera terminal in the direction shown.
- Insert the interface cable's larger plug into the computer. For connection details, refer to the user guide provided with the computer.

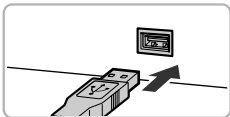

3 Turn on the camera.

- Press the  button to turn on the camera.

4 Open CameraWindow.



Windows

- Click [Downloads Images From Canon Camera using Canon CameraWindow].
- ▶ CameraWindow will appear.
- If CameraWindow does not appear, click the [Start] menu and choose [All Programs], followed by [Canon Utilities], [CameraWindow] and [CameraWindow].

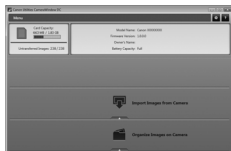



Macintosh

- ▶ CameraWindow will appear when you establish a connection between the camera and computer.
- If CameraWindow does not appear, click the CameraWindow icon on the Dock (the bar which appears at the bottom of the desktop).



For Windows 7, use the following steps to display CameraWindow.

- ① Click  on the task bar.
- ② In the screen that appears, click the  link to modify the program.
- ③ Choose [Downloads Images From Canon Camera using Canon CameraWindow] and click [OK].
- ④ Double click .

Transfer and View Images

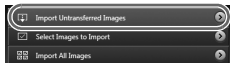

- Click [Import Images from Camera], and then click [Import Untransferred Images].
- ▶ All images not previously transferred will transfer to the computer. Transferred images will be sorted by date and saved in separate folders in the Pictures folder.
- Close CameraWindow when image transfer is complete.
- Turn off the camera and unplug the cable.
- For details on how to view images using a computer, refer to the *Software Guide*.



You can transfer images even without using the image transfer function in the included software by simply connecting your camera to a computer. There are, however, the following limitations.

- It may take a few minutes from when you connect the camera to the computer until you can transfer images.
- Images shot in the vertical orientation may be transferred in the horizontal orientation.
- Protection settings for images may be lost when transferred to a computer.
- There may be problems transferring images or image information correctly depending on the version of the operating system in use, the file size, or the software in use.
- Some functions in the included software may not be available, such as editing movies, and transferring images to the camera.

Accessories

Supplied with Camera



Wrist Strap WS-DC10



Battery Pack NB-6L with Terminal Cover*



Battery Charger CB-2LY/CB-2LYE*

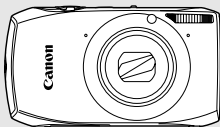

DIGITAL CAMERA Solution Disk

Stereo AV Cable AVC-DC400ST*

Interface Cable IFC-400PCU*

*Also available for purchase separately.



Memory Card



USB card reader



Windows/
Macintosh

Canon-Brand PictBridge Compliant Printers



TV

HDMI Cable HTC-100



High-Definition TV

Separately Sold Accessories

The following camera accessories are sold separately. Some accessories are not sold in some regions, or may no longer be available.

Power Supplies

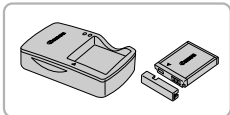

Battery Charger CB-2LY/CB-2LYE

- A charger for charging Battery Pack NB-6L.

Battery Pack NB-6L

- Rechargeable lithium-ion battery.

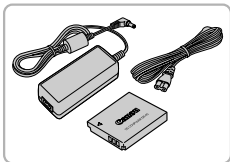

AC Adapter Kit ACK-DC40

- This kit lets you power the camera using household power. Recommended for powering the camera for an extended period of time or when connecting to a computer or printer. Cannot be used to charge the camera battery.



Using accessories abroad

The battery charger and the AC adapter kit can be used in regions that have 100 – 240 V (50/60 Hz) AC power.

If the plug does not fit the outlet, use a commercially available plug adapter. Do not use electrical transformers for foreign travel as they will cause damage.

CAUTION

RISK OF EXPLOSION IF BATTERY IS REPLACED BY AN INCORRECT TYPE.
DISPOSE OF USED BATTERIES ACCORDING TO LOCAL REGULATION.

Other Accessories

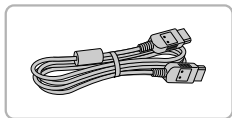

HDMI Cable HTC-100

- Use this cable to connect the camera to the HDMI™ terminal on a high-definition TV set.

Printers



SELPHY series



Inkjet Printers

Canon-Brand PictBridge Compliant Printers

- By connecting your camera to a Canon-brand PictBridge compliant printer, you can print your images without having to use a computer.

For more information, visit your nearest Canon retailer.

Use of genuine Canon accessories is recommended.

This product is designed to achieve excellent performance when used with genuine Canon accessories. Canon shall not be liable for any damage to this product and/or accidents such as fire, etc., caused by the malfunction of non-genuine Canon accessories (e.g., a leakage and/or explosion of a battery pack). Please note that this warranty does not apply to repairs arising out of the malfunction of non-genuine Canon accessories, although you may request such repairs on a chargeable basis.

2

Learning More

This chapter explains the parts of the camera and what appears on the screen, as well as the basic operating instructions.



Components Guide

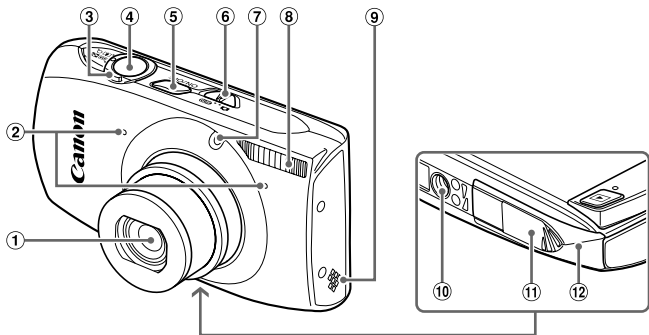



- ① Lens
- ② Microphones (p. 32)
- ③ Zoom Lever
Shooting: [T] (Telephoto) / [W] (Wide Angle) (pp. 26, 31, 55)
Playback: Q (Magnify) / [I] (Index) (pp. 120, 127)
- ④ Shutter Button (p. 24)
- ⑤ ON/OFF button (p. 20)
- ⑥ Mode Switch
- ⑦ Lamp (pp. 58, 78, 171)
- ⑧ Flash (pp. 54, 85)
- ⑨ Speaker
- ⑩ Tripod Socket
- ⑪ DC Coupler Terminal Cover
- ⑫ Memory Card / Battery Cover (p. 17)

Mode Switch

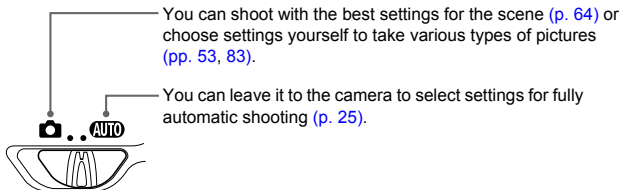
Use the mode switch to change the Shooting mode.

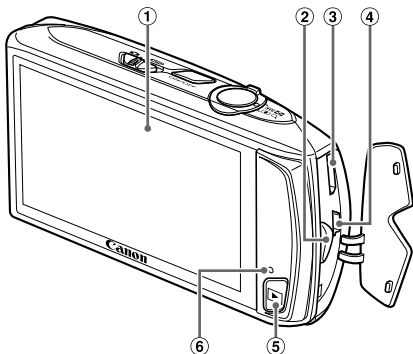



- ① Screen (LCD Monitor) (pp. 44, 187, 189)
- ② Strap Mount (p. 13)
- ③ HDMI Terminal (p. 134)
- ④ A/V OUT (Audio/Video Output) / DIGITAL Terminal (pp. 36, 133, 152)
- ⑤  (Playback) Button (pp. 28, 119)
- ⑥ Indicator (p. 45)

Screen Display

Switching the Display

You can change the screen display by touching **DISP.**. Refer to [p. 187](#) for details on information that appears on the screen.

Shooting



Information Display



No Information Display

Playback



Simple Information Display



Detailed Information Display



Focus Check Display ([p. 126](#))



- Touching **DISP.** while in Playback mode will hide all image information and icons, but you can still switch images ([pp. 28, 29](#)). Touch the screen to restore the original display.
- You can also switch the display by touching **DISP.** while the image displays right after shooting. However, Simple Information Display is not available, and image information will not display. You can change the first screen that displays by choosing the tab, then [Review Info] ([p. 172](#)).

Screen Display in Dark Shooting Conditions

The display automatically brightens when shooting in dark conditions, allowing you to check the composition (Night Display function). However, the brightness of the image on the screen, and the brightness of the actual image recorded may be different. Screen noise may appear and the movement of the subject may appear somewhat jagged on the screen. This has no effect on the recorded image.

Overexposure Warning during Playback

In Detailed Information Display (p. 44), overexposed areas of the image flash on the screen.

Histogram during Playback

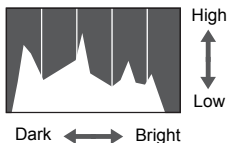

- The graph that appears in Detailed Information Display (p. 189) is called the histogram. The histogram shows the distribution of brightness in an image horizontally, and the amount of brightness vertically. When the graph approaches the right side, the image is bright, but when it approaches the left side, the image is dark, and in this way you can judge the exposure.

Indicator

The indicator on the back of the camera (p. 43) will light or blink depending on the camera's status.

Colors	Status	Operation Status
Green	Lights	Connected to a computer (p. 36)/Display off (p. 169)
	Blinks	During camera start-up, Recording/Reading/Transmitting image data



When the indicator blinks green, do not turn off the power, open the memory card slot/battery cover, shake or jolt the camera. These actions may corrupt the image data or cause the camera or memory card to malfunction.

FUNC. Menu – Basic Operations

Commonly used functions can be set with the FUNC. menu.

The menu items and options differ depending on the Shooting mode (pp. 192 – 195) or Playback mode (p. 200).



1 Display the FUNC. menu.

- Touch FUNC..

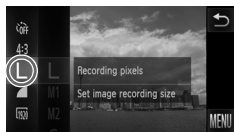

2 Choose a menu item.



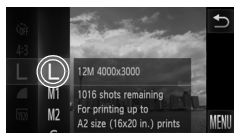



- Drag up or down the menu on the left, or touch a menu item to choose it.
- You can also choose menu items by dragging on the screen outside of the menu.
- Touch the menu item you chose again, or touch the menu on the right.



3 Choose an option.

- Drag up or down the menu on the right, or touch an item to choose it.
- You can also choose menu items by dragging on the screen outside of the menu.
- Touch the menu item you chose again, or touch ↶.
- ▶ The item will be set, and the original screen will reappear.
- To choose a different item from the menu on the left, touch the appropriate item.
- In the screen in Step 2, you can also touch items to choose them in the menu to the right.



The options on the right will not appear if you have selected any of the following items from the FUNC. menu while in Playback mode:  (p. 144),  (p. 159),  (p. 137),  (p. 141),  (p. 30),  (p. 122), (p. 130), (p. 143).

MENU – Basic Operations

Various functions can be set from the menus. The menu items are organized under tabs, such as for shooting (📷) and playback (▶). The options differ depending on the Shooting mode and the Playback mode (pp. 196 – 199).



1 Display the menu.

- Touch FUNC., then touch MENU.

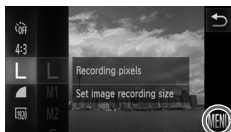

2 Choose a tab.

- Touch a tab, or move the zoom lever (p. 42) left or right to choose a tab.

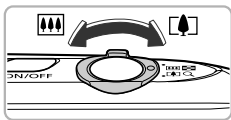
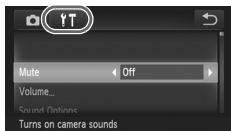

3 Choose an item.

- Drag up or down the screen, or touch an item to choose it.
- Some items require you to touch the item to display a submenu in which you change the setting.

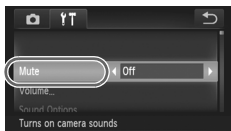



4 Choose an option.

- For items that display ◀▶ to the left and right, touch ◀▶ to change settings.
- For items that display a bar, touch the spot on the bar where you want to make the setting.

5 Complete the setting.

- Touch ↶.
- ▶ The normal screen will reappear.

Changing the Sound Settings

You can silence or adjust the volume of camera sounds.

Muting Sounds

1 Display the menu.

- Touch **FUNC.**, then touch **MENU**.

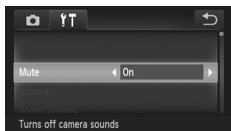

2 Choose [Mute].

- Touch the **FUNC.** tab.
- Drag up or down the screen to choose [Mute], then touch **▶◀** to choose [On].



If you mute camera sounds, the sound will also be muted when playing back movies (p. 33). If you drag up the screen while viewing a movie, the sound will turn on. You can then adjust the volume by dragging up or down the screen.

Adjusting the Volume

1 Display the menu.

- Touch **FUNC.**, then touch **MENU**.

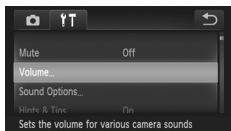

2 Choose [Volume].

- Touch the **FUNC.** tab.
- Drag up or down the screen to touch [Volume].

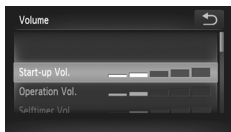

3 Change the volume.

- Drag up or down the screen to choose an item, then touch the point on the bar where you want to change the volume.

Adjusting the Screen Brightness

You can adjust the brightness of the screen.

1 Display the menu.

- Touch **FUNC.**, then touch **MENU**.

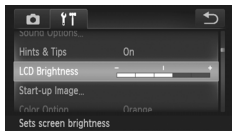

2 Choose [LCD Brightness].

- Touch the **☿** tab.
- Drag up or down the screen to choose [LCD Brightness].

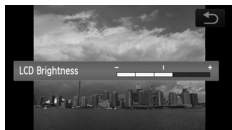

3 Adjust the brightness.

- Touch the point on the bar where you want to change the brightness.

Returning the Camera to Default Settings

When you have mistakenly changed a setting, you can reset the camera to the default settings.

1 Display the menu.

- Touch **FUNC.**, then touch **MENU**.

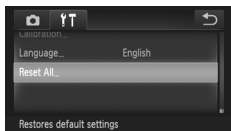

2 Choose [Reset All].

- Touch the **⚙** tab.
- Drag up or down the screen to touch **[Reset All]**.

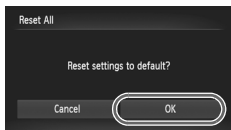

3 Reset the settings.

- Touch **[OK]**.
- ▶ The camera will reset to the default settings.



Are there functions that cannot be reset?

- The **[Date/Time]** (p. 21), **[Language]** (p. 22), **[Video System]** (p. 133), **[Time Zone]** (p. 169), the image registered in **[Start-up Image]** (p. 166), and **[Calibration]** (p. 170) in the **⚙** tab.
- The recorded custom white balance data (p. 87).
- Colors that were chosen in **Color Accent** (p. 72) or **Color Swap** (p. 73).
- Shooting modes set when the mode switch was set to **📷** (pp. 63, 111).

Power Saving Function (Auto Power Down)

To save battery power, the screen turns off, and the camera shuts down automatically when it is not operated for a certain time.

Power Saving during Shooting

The screen will turn off approximately 1 minute after you stop operating the camera. After about 2 more minutes, the lens will retract and the power will turn off. When the screen has turned off but the lens has not yet retracted, pressing the shutter button halfway (p. 24) turns on the screen and shooting can continue.

Power Saving during Playback

The power will turn off approximately 5 minutes after you stop operating the camera.



- You can turn off the power saving function (p. 168).
- You can adjust the time before the screen turns off (p. 169).

3

Shooting with Commonly Used Functions

This chapter explains how to use common functions, such as the self-timer, and how to turn off the flash.

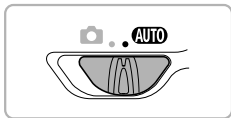

- This chapter assumes that the camera is set to **AUTO** mode. When shooting in another mode, check which functions are available in that mode (pp. 192 – 195).

Turning the Flash Off





You can shoot with the flash turned off.

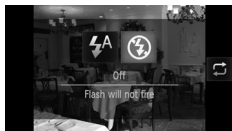

1 Touch .



2 Choose .

- Touch .
- Touch  again to make the setting.
- ▶ Once set,  will appear on the screen.
- To turn the flash back on, follow the steps above to choose .

? What if a flashing appears?

When you press the shutter button halfway in low light conditions where camera shake is likely, a flashing  will appear on the screen. Attach the camera to a tripod to prevent it from moving.



You can also choose items by touching  in Step 2.

Zooming in More Closely on Subjects (Digital Zoom)

You can use the digital zoom to zoom up to approximately 18x maximum, and capture subjects that are too far away for the optical zoom to enlarge. However, depending on the recording pixel setting (p. 60) and zoom factor, the images may appear coarse (the zoom factor will appear in blue).

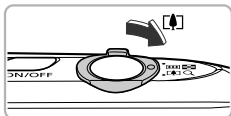

1 Move the zoom lever toward [📷➡].

- Hold the lever until zooming stops.
- ▶ Zooming stops at the largest possible zoom factor without image deterioration. The zoom factor will appear on the screen when you release the zoom lever.

Zoom Factor



2 Move it toward [📷➡] again.

- ▶ The digital zoom will zoom in even further on the subject.



Turning off the digital zoom

To turn off the digital zoom, touch **FUNC.**, then touch **MENU** to choose the  tab, and choose [Digital Zoom] and the [Off] option.



The focal length when using the optical zoom and digital zoom together is approximately 24 – 420 mm, and 24 – 105 mm when using the optical zoom alone (all focal lengths are 35mm film equivalent).

Digital Tele-Converter

The focal length of the lens can be increased by approximately 1.5x or approximately 2.0x. This enables a faster shutter speed and less chance of camera shake than the zoom (including digital zoom) used by itself at the same zoom factor.

However, a recording pixel setting (p. 60) of **L** or **M1** will cause images to appear coarse (the zoom factor will appear in blue).

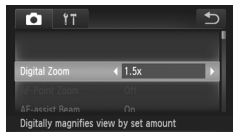

1 Choose [Digital Zoom].

- Touch **FUNC.**, then touch **MENU**.
- Touch the tab.
- Drag up or down the screen to choose [Digital Zoom].

2 Choose the setting.

- Touch to choose a zoom factor.
- Touching restores the settings screen.
- ▶ The view will be enlarged and the zoom factor will appear on the screen.
- To return to standard digital zoom, choose [Digital Zoom] and the [Standard] option.



- The respective focal lengths when using [1.5x] and [2.0x] are approximately 36.0 – 157.5 mm and approximately 48.0 – 210.0 mm (35mm film equivalent).
- The digital tele-converter cannot be used together with the digital zoom.
- The shutter speeds may be the same when at maximum telephoto , and when zoomed in on the subject using Step 2 on p. 55.

Inserting the Date and Time

You can insert the shooting date and time in the lower right corner of an image. Once inserted, however, they cannot be deleted. Be sure to check beforehand that the date and time are correctly set (p. 20).

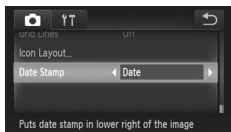

1 Choose [Date Stamp].

- Touch **FUNC.**, then touch **MENU**.
- Touch the tab.
- Drag up or down the screen to choose [Date Stamp].

2 Choose the setting.

- Touch to choose [Date] or [Date & Time].
- Touching restores the settings screen.
- ▶ Once set, [DATE] will appear on the screen.



3 Shoot.

- ▶ The shooting date or time will be recorded in the image's lower right corner.
- To restore to the original setting, choose [Off] in Step 2.



You can insert and print the shooting date in images which do not have an embedded date and time as follows. However, if you do this for images with an embedded date and time, the date and time may be printed twice.

- Use the **DPOF print settings** (p. 159) to print.
- Use the **included software to print**.
Refer to the *Software Guide* for details.
- Print using **printer functions** (p. 151).

Using the Self-Timer



The self-timer can be used to shoot a group photo that includes the photographer. The camera will shoot approximately 10 seconds after the shutter button is pressed.



1 Touch .



2 Choose .

- Touch .
- Touch  again to make the setting.
- ▶ Once set,  will appear on the screen.

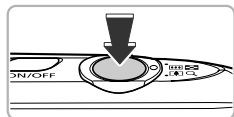

3 Shoot.

- Press the shutter button halfway to focus on the subject, then press it fully.
- ▶ When the self-timer starts, the lamp blinks and the self-timer sound plays.
- ▶ Two seconds before the shutter releases, the lamp and sound speed up (the lamp remains lit when the flash will fire).
- To cancel shooting with the timer after countdown has started, touch the screen.
- To restore the original setting, choose  in Step 2.





- You can also choose items by touching  in Step 2.
- You can change the delay and number of shots (p. 59).
- You can also make settings in the FUNC. menu that appears when you touch FUNC..

Using the Self-Timer to Prevent Camera Shake

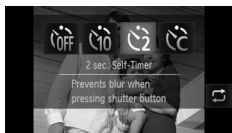
The camera will shoot approximately 2 seconds after the shutter button is pressed, preventing any camera shake that occurs when pressing the shutter button.



Choose .



- Follow Steps 1 – 2 on [p. 58](#) to choose .
- ▶ Once set,  will appear on the screen.
- Follow Step 3 on [p. 58](#) to shoot.

Customizing the Self-Timer

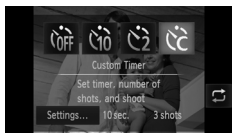
You can set the delay (0 – 30 seconds) and the number of shots (1 – 10 shots).



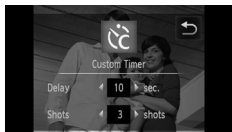

1 Choose .

- Touch  and , then immediately touch [Settings].



2 Choose the settings.

- Touch   to choose a value for the desired option.
- Touch  to make the setting.
- Follow Step 3 on [p. 58](#) to shoot.

? What if the number of shots is set to two or more shots?

- Exposure and white balance settings are set with the first shot.
- If the flash fires or you set a high number of shots, the shooting interval may take longer than usual.
- If the memory card fills, shooting stops automatically.



When you set the delay for more than 2 seconds, the lamp and self-timer sound speed up 2 seconds before the shutter releases (the lamp remains lit when the flash will fire).

Changing the Recording Pixel Setting (Image Size)

You can choose from 4 recording pixel settings.

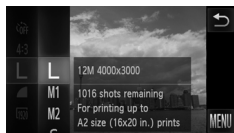



1 Choose the recording pixel setting.

- Touch **FUNC.**, then drag up or down the menu on the left to choose **L**.

2 Choose an option.

- Touch an item you want to set.
- If you drag up or down the menu on the right, other items will appear.
- Touch the menu item again to complete the setting.
- ▶ The setting will appear on the screen.
- To restore to the original setting, choose **L** in Steps 1 – 2.

Changing the Compression Ratio (Image Quality)

You can choose from the following 2 compression ratios (image quality):  (Fine),  (Normal).

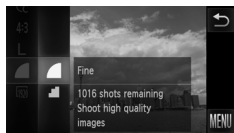









1 Choose the compression ratio setting.

- Touch **FUNC.**, then drag up or down the menu on the left to choose .

2 Choose an option.

- Touch an item you want to set.
- Touch the menu item again to complete the setting.
- ▶ The setting will appear on the screen.
- To restore the original setting, choose  in Steps 1 – 2.

Approximate Values for Recording Pixels and Compression Ratio (for 4:3 Aspect Ratios)

Recording Pixels	Compression Ratio	Single Image Data Size (Approx. KB)	Number of Shots per Memory Card (Approx. shots)	
			4 GB	16 GB
L (Large) 12M/4000x3000		3084	1231	5042
		1474	2514	10295
M1 (Medium 1) 6M/2816x2112		1620	2320	9503
		780	4641	19007
M2 (Medium 2) 2M/1600x1200		558	6352	26010
		278	12069	49420
S (Small) 0.3M/640x480		150	20116	82367
		84	30174	123550

- The values in the table are measured according to Canon standards and may change depending on the subject, memory card and camera settings.
- The values in the table are based on 4:3 aspect ratio. If the aspect ratio is changed (p. 90), more images can be shot because the data size per image will be smaller than with 4:3 images. However, since **M2** 16:9 images have a setting of 1920 x 1080 pixels, their data size will be larger than 4:3 images.

Approximate Values for Paper Size (for 4:3 Aspect Ratios)

A2 (16.5 x 23.4 in.)	L
A3 – A5 (11.7 x 16.5 – 5.8 x 8.3 in.)	
5 x 7 in. Postcard size 3.5 x 5 in.	

- **S** For sending images as e-mail attachments.

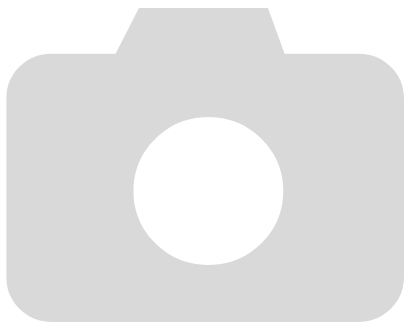

4

Adding Effects and Shooting in Various Conditions

This chapter explains how to add effects and how to shoot in various conditions.



Shooting in Various Conditions

The camera will select the necessary settings for the conditions in which you wish to shoot when you choose the matching mode.



1 Set the camera to mode.

- Set the mode switch to .





2 Choose a Shooting mode.

- Touch **P**.

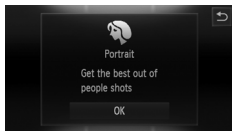

- If you touch  or quickly drag left or right across the screen, other Shooting modes will appear.
- Choose the desired shooting mode.



- ▶ An explanation of the chosen Shooting mode appears on the screen.
- Touch [OK] to complete the setting.
- Touch  to restore the Shooting mode selection screen.

3 Shoot.

Take portraits (Portrait)

- Produces a soft effect when photographing people.





Take shots of kids and pets (Kids&Pets)

- Lets you capture subjects that move around, such as children and pets, without missing photo opportunities.
- Move approximately 1 m (3.3 ft.) or more away from your subject and shoot.



Take nightscapes without using a tripod (Handheld NightScene)

- Lets you take beautiful snapshots of city nightscapes by combining several continuous shots to reduce camera shake and noise.
- When using a tripod, you should shoot in **AUTO** mode (p. 25).

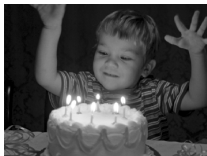

Take shots in low light conditions (Low Light)

- Lets you take shots in dark places with reduced camera shake and subject blur.



Take shots of people at the beach (Beach)

- Lets you take shots of brightly lit people on sandy beaches where the reflected sunlight is strong.



Take shots of foliage (Foliage)

- Lets you shoot trees and leaves, such as new growth, autumn leaves or blossoms, in vivid colors.



Take shots of people in snow **(Snow)**



- Lets you take bright, natural-colored shots of people against snowy backgrounds.







Take shots of fireworks **(Fireworks)**

- Lets you take shots of fireworks in vivid colors.



- In  mode, hold the camera firmly while shooting as multiple images are captured in succession.
- In  mode, attach the camera to a tripod to prevent the camera from moving and blurring the image. Additionally, you should set [IS Mode] to [Off] when shooting with a tripod ([p. 173](#)).



- In  mode, the recording pixel setting will be fixed at **M** (1984 x 1488 pixels).
- In  or  mode, images may appear coarse because the ISO speed ([p. 88](#)) is increased to match the shooting conditions.
- If camera shake is too strong while shooting in  mode, the camera may not be able to combine images or you may not obtain the expected result depending on shooting conditions.

Making Short Movies Automatically (Movie Digest)

You can make a short movie of a day just by taking still images. Each time you take a picture, the scene just before taking your shot will be recorded as a movie. All the movies recorded that day will be saved as a single file.



1 Choose .

- Follow Steps 1 – 2 on [p. 64](#) to choose .

2 Shoot.

- Press the shutter button fully to shoot a still image.
 - ▶ A movie of approx. 2 – 4 sec. will be recorded just before the image is taken.

? What if a movie is not recorded?



If you take a picture just after turning on the camera, selecting  mode or otherwise operating the camera, a movie may not be recorded.



Viewing movies made with Movie Digest

You can select movies made in  mode by date for viewing ([p. 122](#)).



- Since you are also shooting movies when you shoot still images, the battery will be depleted more quickly than in **AUTO**.
- The image quality will be fixed at **640** for movies shot in  mode.
- In the following cases, movies will be saved as separate files even if they were shot on the same day with  mode.
 - If the clip file size reaches 4 GB or the recording time reaches approximately 1 hour
 - If the movie is protected ([p. 137](#))
 - If the Time Zone setting is changed ([p. 169](#))
 - If a new folder is created ([p. 168](#))
- If you operate the camera while shooting a movie, the sounds made will be recorded in the movie.
- The camera will not play sounds, such as when pressing the shutter button halfway, using the controls or the self-timer ([p. 164](#)).

Adding Effects and Shooting





You can add various effects to images when shooting.

1 Choose a Shooting mode.

- Follow Steps 1 – 2 on p. 64 to choose a Shooting mode.

2 Shoot.



Since you may not achieve the expected results with images shot in , , , and  modes, try taking some test shots first.



Shoot images with vivid colors (Super Vivid)

- Lets you take shots with vivid, intense colors.



Take posterized shots (Poster Effect)

- Lets you take shots that look like an old poster or illustration.

Shoot with the Effects of a Fish-Eye Lens (Fish-eye Effect)



Lets you shoot with the distorting effect of a fish-eye lens.

1 Choose .

- Follow Steps 1 – 2 on [p. 64](#) to choose .



2 Choose an effect level.

- Touch .
- ▶ [Effect Level] will appear on the screen.
- Touch  to choose an effect level, then touch .
- ▶ You can check the effect on the screen.

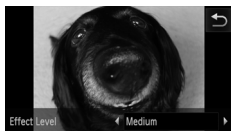

3 Shoot.

Take Shots That Look Like a Miniature Model (Miniature Effect)





Blurs chosen portions in the top and bottom of an image to produce the effect of a miniature model.

1 Choose .

- Follow Steps 1 – 2 on [p. 64](#) to choose .
- ▶ A white frame (the area that will not be blurred) appears on the screen.





2 Choose the area to keep in focus.

- Touch the screen or drag the white frame up or down to change the area to keep in focus.
- Touch , then touch ,  or  to change the size of the focused area and touch .



3 Shoot.



- If you touch  in Step 2, the frame will switch to vertical orientation. You can change the area to keep in focus by touching the screen or dragging the white frame left or right. Touch  again to return the frame orientation to horizontal.
- Holding the camera vertically will change the orientation of the frame.
- Be sure to set a playback speed before shooting a Miniature Effect movie ([p. 113](#)).

Special Effects for Night Backgrounds (Creative Light Effect)



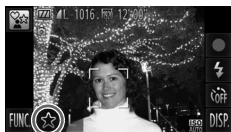

Light displays and other points of light in the night backgrounds behind your subject can be changed into 6 different shapes. Be sure to use the flash when shooting.

1 Choose .

- Follow Steps 1 – 2 on [p. 64](#) to choose .



2 Choose a shape and size.

- Touch .
- ▶ [Select Effect] will appear on the screen.
- Touch the desired shape.
- Touch   to choose a size, then touch .



3 Shoot.

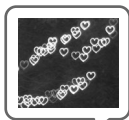

Shooting tips

- Hold the camera firmly and shoot non-moving points of light in as dark a location as possible.
- Make sure your subject is within the range of the flash ([p. 85](#)). Also make sure the subject is not illuminated by any other light sources.



In some shooting conditions, such as when shooting moving points of light, the chosen shape may not show, and the brightness may be different than expected.

Changing the Color and Shooting

You can change the look of an image when shooting. However, depending on shooting conditions, the image may become coarse, or the colors may not come out as expected.

Color Accent

You can choose to retain a single color and change the rest to black and white in a composition.



1 Choose .

- Follow Steps 1 – 2 on [p. 64](#) to choose .



2 Touch .

- ▶ The unchanged image and the Color Accent image will alternately display.
- The color for default settings is green.

3 Specify the color.

- Position the center frame so it is filled with the color you want and touch the frame on the lower part of the screen.
- ▶ The specified color will be recorded.

4 Specify the range of colors.

- Touch   to change the range of colors to be retained.
- Choose a negative value to limit the range of colors. Choose a positive value to extend the range of colors to similar colors.
- Touching  restores the shooting screen.



Recorded color



Using the flash may cause unexpected results in this mode.

Color Swap

You can swap one color in an image for another when recording it. You can only swap one color.



1 Choose .

- Follow Steps 1 – 2 on [p. 64](#) to choose .



2 Touch .

- ▶ The unchanged image and the Color Swap image will alternately display.
- The default setting is to change green to gray.



3 Specify the color to be swapped.



- Position the center frame so it is filled with the color you want and touch the left frame that appears in the lower left of the screen.
- ▶ The specified color will be recorded.



4 Specify the target color.

- Position the center frame so it is filled with the color you want and touch the right frame that appears in the lower left of the screen.
- ▶ The specified color will be recorded.

5 Specify the range of colors to be swapped.

- Touch   to change the range of colors to be retained.
- Choose a negative value to limit the range of colors. Choose a positive value to extend the range of colors to similar colors.
- Touching  restores the shooting screen.



- Using the flash may cause unexpected results in this mode.
- Under some conditions, the image may appear coarse.

Shooting in Monochrome

You can shoot images in black and white, sepia or blue and white.

1 Choose .



- Follow Steps 1 – 2 on [p. 64](#) to choose .



2 Choose a color tone.

- Touch .
- ▶ [Color Tone] will appear on the screen.



- Touch  to choose an effect, then touch .
- ▶ You can check the color tone on the screen.

3 Shoot.

B/W	Shoots in black and white.
Sepia	Shoots with sepia tones.
Blue	Shoots in blue and white.





Shoot with the Effects of a Toy Camera (Toy Camera Effect)

This effect darkens and blurs the corners of the image, and changes the overall color so that it looks like an image shot with a toy camera.

1 Choose .

- Follow Steps 1 – 2 on [p. 64](#) to choose .

2 Choose a color tone.

- Touch .
- ▶ [Color Tone] will appear on the screen.
- Touch   to choose an effect, then touch .
- ▶ You can check the color tone on the screen.



3 Shoot.

Standard	Images will look like they were shot with a toy camera.
Warm	Gives images a warmer tone than [Standard].
Cool	Gives images a cooler tone than [Standard].

Detecting a Face and Shooting (Smart Shutter)

Detecting a Smile and Shooting

The camera will shoot, even without pressing the shutter button, when it detects a smile.

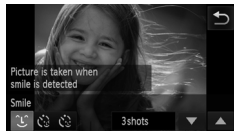

1 Choose ☺.

- Choose in Steps 1 – 2 on p. 64, then touch ☺.
- Touch ☺, then touch ↶.
- ▶ The camera will enter shooting preparation.



2 Point the camera at a person.

- Each time the camera detects a smile it will shoot after the lamp lights.
- Touching ☺_{ON} will pause smile detection. Touch ☺_{OFF} to resume smile detection.

Smile detection:
On/Off

Number of shots, switching modes (pp. 77, 78)

? What if a smile is not detected?

Smiles are easier to detect if the subject faces the camera, and opens their mouth enough to show some teeth when smiling.



Changing the number of shots

Touch ☺, then touch ▲▼ to choose the number of shots. Touch ↶ to change the setting.





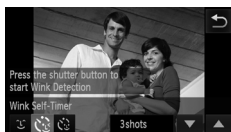

- You should switch to another mode when you finish shooting, or the camera will continue taking shots each time the camera detects a smile.
- You can also shoot by pressing the shutter button.

Using the Wink Self-Timer

Point the camera at a person and press the shutter button fully. The camera will shoot approximately two seconds after it detects a wink.



1 Choose .

- Choose  in Steps 1 – 2 on p. 64, then touch .
- Touch , then touch .

2 Compose the shot and press the shutter button halfway.

- Touch a face displayed on the screen to choose a person to wink (Touch AF).
- Confirm that a green frame appears around the face of the person who will wink.

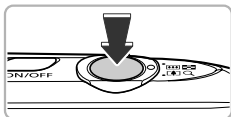

3 Press the shutter button fully.

- ▶ The camera will enter shooting stand-by, and [Wink to take picture] will appear on the screen.
- ▶ The lamp will blink and the self-timer sound will play.

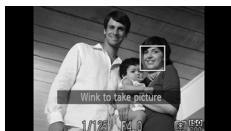

4 Face the camera and wink.





- ▶ The shutter will release approximately 2 seconds after a wink is detected from the person inside the frame.
- To cancel shooting with the timer after countdown has started, touch the screen.

? What if a wink is not detected?

- Wink a bit slowly.
- A wink may not be detected if eyes are covered by hair or a hat, or when wearing glasses.



Changing the number of shots

After touching  on the screen in Step 1, touch   to change the number of shots. Touch  to complete the setting.







- Shutting both eyes will also be detected as a wink.
- If a wink is not detected, the shutter will release approximately 15 seconds later.
- If there are no people in the shot when the shutter button is pressed fully, the camera will shoot after a person enters the shot and winks.

Using the Face Self-Timer

The shutter will release approximately two seconds after the camera detects a new face (p. 95). You can use this when the photographer wants to be in the image, such as a group photo.



1 Choose .

- Choose  in Steps 1 – 2 on p. 64, then touch .
- Touch , then touch .

2 Compose the shot and press the shutter button halfway.

- Make sure a green frame appears on the face focused on and white frames appear on other faces.

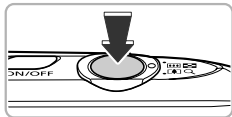

3 Press the shutter button fully.

- ▶ The camera will enter shooting stand-by, and [Look straight at camera to start count down] will appear on the screen.
- ▶ The lamp will blink and the self-timer sound will play.



4 Join the subjects and look at the camera.

- ▶ When the camera detects a new face, the lamp and self-timer sound will speed up (the lamp remains lit when the flash will fire), and two seconds later the shutter will release.
- To cancel shooting with the timer after countdown has started, touch the screen.



Changing the number of shots

After touching  in the screen in Step 1, touch ▲▼ to change the number of shots, then touch ↻ to complete the setting.



Even if your face is not detected after joining the subjects, the shutter will release approximately 15 seconds later.

High-Speed Continuous Shooting (High-speed Burst)

You can shoot continuously at a maximum speed of approximately 8.2 images/second while the shutter button is pressed fully and held.



1 Choose .

- Follow Steps 1 – 2 on [p. 64](#) to choose .

2 Shoot.

- ▶ As long as you hold the shutter button down, the camera will shoot successive images.



- The recording pixel setting will be fixed at **M** (1984 x 1488 pixels).
- The focus, brightness and white balance will be set with the first shot.
- Depending on the shooting conditions, camera settings and the zoom position, the camera may stop shooting momentarily, or the shooting speed may slow down.
- As the number of images increases, the shooting speed may slow down.

Images Displayed During Playback

Since each set of continuous images will become a single group, only the first image captured in that group will be displayed. To indicate that the image is part of a group,  will appear on the screen.



If you erase a grouped image ([p. 139](#)), all the images in the group will also be erased. Be sure to exercise adequate caution.



- If you want to play back images individually ([p. 128](#)), grouping can be canceled ([p. 129](#)).
- Protecting ([p. 137](#)) a grouped image, will protect all of the images in the group.
- If you play back grouped images using Filtered Playback ([p. 123](#)) or Smart Shuffle ([p. 130](#)), grouping is temporarily canceled and images are played back individually.
- Grouped images cannot use certain touch actions ([p. 131](#)), be tagged as favorites ([p. 141](#)), edited ([pp. 144 – 150](#)), categorized ([p. 143](#)), printed ([p. 152](#)) or have the number of copies to be printed set ([p. 161](#)). Play back grouped images individually ([p. 128](#)), or cancel grouping ([p. 129](#)) before trying the above.

Capturing the Best Facial Expressions (Best Image Selection)

The camera takes 5 continuous shots, then detects various aspects of the shot such as facial expressions, and saves only one picture detected as the best.



1 Choose .

- Follow Steps 1 – 2 on [p. 64](#) to choose .

2 Shoot.

- ▶ When the shutter button is pressed fully, the camera takes five continuous shots, and saves one picture only.



- The recording pixel setting will be fixed at **M** (1984 x 1488 pixels).
- The focus, brightness and white balance will be set with the first shot.
- Depending on the shooting conditions, you may not obtain the expected results.



5

Choosing Settings Yourself

In this chapter you will learn how to use the various functions in **P** mode to progressively advance your shooting skills.

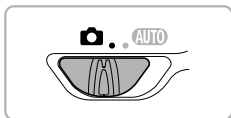

- This chapter assumes that you have set the mode switch to  and the camera is in **P** mode.
- **P** stands for Program AE.
- Before attempting to shoot using a function explained in this chapter in modes other than **P** mode, check if the function is available in those modes (pp. 192 – 197).

Shooting in Program AE

You can choose the settings for various functions to suit your preferences. AE stands for Auto Exposure.

The focusing range is approximately 5 cm (2.0 in.) – infinity at maximum wide angle (☐), and approximately 40 cm (1.3 ft.) – infinity at maximum telephoto (☐).



1 Enter **P** mode.

- Follow Steps 1 – 2 on [p. 64](#) to choose **P**.

2 Adjust the settings according to your purposes ([pp. 85 – 105](#)).

3 Shoot.



What if the shutter speed and aperture value appear in orange?

If a correct exposure cannot be obtained when pressing the shutter button halfway, the shutter speed and aperture value appear in orange. Try the following settings to obtain the correct exposure.

- Turn on the flash ([p. 85](#))
- Choose a higher ISO speed ([p. 88](#))

Adjusting the Brightness (Exposure Compensation)

You can adjust the standard exposure set by the camera in 1/3-stop increments in the range of -2 to +2.



1 Enter Exposure Compensation mode.

- Touch ± 0 .



2 Adjust the brightness.



- While looking at the screen, touch the bar, or drag it left or right, to adjust the brightness, then touch .
- ▶ The exposure compensation amount will appear on the screen.



You can also make settings in the FUNC. menu that appears when you touch FUNC..





Turning the Flash On

You can make the flash fire every time you shoot.

The effective flash range is approximately 50 cm – 5.0 m (1.6 – 16 ft.) at maximum wide angle () , and approximately 50 cm – 2.0 m (1.6 – 6.6 ft.) at maximum telephoto () .



Choose .

- Touch , then touch .
- Touch  again to make the setting.
- ▶ Once set,  will appear on the screen.



The edges of the image may darken if the flash fires.



You can also choose items by touching .

Adjusting the White Balance

The white balance (WB) function sets the optimal white balance for natural looking colors to match the shooting conditions.

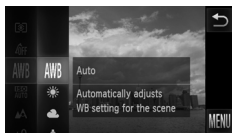







1 Choose the white balance function.

- Touch **FUNC.**, then drag up or down the menu on the left to choose **AWB**.

2 Choose an option.



- Touch an item you want to set.
- If you drag up or down the menu on the right, other items will appear.
- Touch the menu item again to complete the setting.
- ▶ The setting will appear on the screen.

 Auto	Automatically sets the optimal white balance for the shooting conditions.
 Day Light	For shooting outdoors, in fine weather conditions.
 Cloudy	For shooting in cloudy, shady or twilight conditions.
 Tungsten	For shooting under tungsten and bulb-type (3-wavelength) fluorescent lighting.
 Fluorescent	For shooting under warm-white fluorescent, cool-white fluorescent and warm-white-type (3-wavelength) fluorescent lighting.
 Fluorescent H	For shooting under daylight fluorescent and daylight-type (3-wavelength) fluorescent lighting.
 Custom	For manually setting a custom white balance.

Custom White Balance

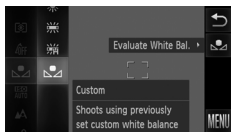
You can adjust the white balance to match the light source at the shooting location. Make sure that you set the white balance under the light source of the actual scene you will shoot.



- Follow Step 2 on [p. 86](#) to choose .
- Make sure the entire screen is filled with a plain, white colored subject, then touch  on the right.
- ▶ The tint on the screen will change when white balance data is set.



If you change camera settings after recording white balance data, the tone may not turn out properly.

Changing the ISO Speed

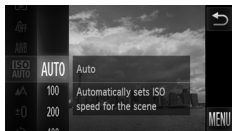

1 Choose the ISO speed.

- Touch **FUNC.**, then drag up or down the menu on the left to choose **ISO AUTO**.

2 Choose an option.

- Touch an item you want to set.
- If you drag up or down the menu on the right, other items will appear.
- Touch the menu item again to complete the setting.
- ▶ The setting will appear on the screen.

ISO AUTO	Automatically adjusts the ISO speed to the Shooting mode and shooting conditions.	
ISO 100 ISO 200	Low	For shooting outdoors, in fine weather conditions.
ISO 400 ISO 800	↕	For shooting in cloudy, or twilight conditions.
ISO 1600 ISO 3200	High	For shooting nightscapes, or in dark interiors.



Changing the ISO speed

- Lowering the ISO speed results in sharper images, but there may be an increased chance of image blurring in certain shooting conditions.
- Raising the ISO speed results in a faster shutter speed, reducing image blurring and letting the flash reach greater distances to the subject. The images, however, will appear coarse.





When the camera is set to **ISO AUTO**, you can press the shutter button halfway to display the automatically set ISO speed.

Correcting the Brightness and Shooting (i-Contrast)

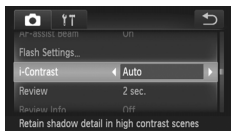
The camera can detect areas in the scene, such as faces or backgrounds, that are too bright or dark and automatically adjust them to the optimum brightness when shooting. Also, when the overall image is lacking in contrast, the camera will automatically correct the image for a sharper impression when shooting.



Choose [i-Contrast].

- Touch **FUNC.**, then **MENU** to choose the  tab. Touch [i-Contrast], then touch ◀▶ to choose [Auto].
- ▶ Once set,  will appear on the screen.



- Under some conditions, the image may appear coarse or may not be corrected properly.
- You can correct recorded images ([p. 149](#)).

Changing the Aspect Ratio

You can change the width to height ratio of an image.

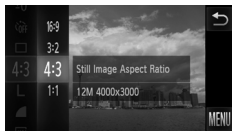

1 Choose 4:3.

- Touch **FUNC.**, then drag up or down the menu on the left to choose **4:3**.

2 Choose an option.

- Touch an item you want to set.
- If you drag up or down the menu on the right, other items will appear.
- Touch the menu item again to complete the setting.
- ▶ Once set, the aspect ratio of the screen will change.

16:9	The same aspect ratio as the screen of this camera, used for displaying on wide-screen HD TVs.
3:2	The same aspect ratio as 35mm film, used for printing out 5 x 7 in. or postcard sized images.
4:3	The same aspect ratio as standard televisions, used for printing images on 3.5 x 5 in. to various A-sized papers.
1:1	A square-shaped aspect ratio.



The digital zoom (p. 55) and digital tele-converter (p. 56) are only available in the **4:3** aspect ratio since [Digital Zoom] is fixed to [Off].



How can I shoot with the display at full screen?

Set the aspect ratio to **16:9**. However, shooting at a 16:9 aspect ratio will result in images whose aspect ratio does not match 5 x 7 in., Postcard size, 3.5 x 5 in., or various A sizes of paper when printing. White margins may be left in the print, and some portions of the image may not print.

Continuous Shooting

You can shoot continuously at a maximum speed of approximately 3.4 images/second while the shutter button is pressed fully and held.

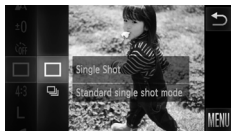

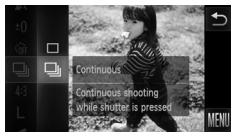

1 Choose a Drive mode.

- Touch **FUNC.**, then drag up or down the menu on the left to choose .



2 Choose an option.

- Touch .
- Touch  again to make the setting.
- ▶ Once set,  will appear on the screen.

3 Shoot.

- ▶ As long as you hold the shutter button down, the camera will shoot successive images.



- Cannot be used with the self-timer (pp. 58, 59).
- Continuous shooting speed increases in  mode (p. 65).
- For continuous shooting, the focus and exposure are locked when the shutter button is pressed halfway.
- Depending on the shooting conditions and the camera settings, the camera may stop shooting momentarily, or the shooting speed may slow down.
- As the number of images increases, the shooting speed may slow down.
- If the flash fires, the shooting speed may slow down.

Changing the Tone of an Image (My Colors)

You can change the tone of an image, for example to sepia or black and white, when shooting.

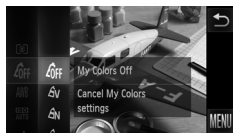

1 Choose My Colors.

- Touch **FUNC.**, then drag up or down the menu on the left to choose **OFF**.

2 Choose an option.

- Touch an item you want to set.
- If you drag up or down the menu on the right, other items will appear.
- Touch the menu item again to complete the setting.
- ▶ The setting will appear on the screen.

My Colors Off	—
Vivid	Emphasizes the contrast and color saturation for a vivid impression.
Neutral	Tones down the contrast and color saturation for neutral hues.
Sepia	Changes the image to sepia tones.
B/W	Changes the image to black and white.
Positive Film	Combines the effects of Vivid Red, Vivid Green and Vivid Blue to produce intense natural appearing colors like those obtained with positive film.
Lighter Skin Tone	Makes skin tones lighter.
Darker Skin Tone	Makes skin tones darker.
Vivid Blue	Emphasizes blue tints. Makes the sky, ocean and other blue subjects more vivid.
Vivid Green	Emphasizes green tints. Makes mountains, foliage and other green subjects more vivid.
Vivid Red	Emphasizes red tints. Makes red subjects more vivid.
Custom Color	You can adjust contrast, sharpness, and color saturation etc. to your preference (p. 93).



- The white balance cannot be set in and (p. 86).
- In and , colors other than people's skin color may change. You may not obtain the expected results with some skin colors.

Custom Color

The contrast, sharpness, color saturation, red, green, blue, and skin tones in an image can be chosen and set at 5 different levels.

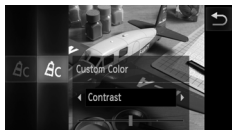

- Follow Step 2 on [p. 92](#) to choose **AC**.
- Touch **C** on the right side of the screen.
- Touch **◀▶** to choose an item, then touch the point on the bar where you want to make a setting.
- The more to the right, the stronger/darker (skin tone) the effect gets, the more to the left, the weaker/lighter (skin tone) the effect gets.
- Touch **↶** to make the setting.

Shooting Close-ups (Macro)

You can shoot an object at a close distance or even shoot extreme close-ups of it. The focusing range is approximately 3 – 50 cm (1.2 in. – 1.6 ft.) from the end of the lens at maximum wide angle (📷).

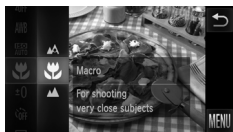

Choose 🌸.

- Touch **FUNC.**, then drag up or down the menu on the left to choose 🌸.
- Touch 🌸, then touch 🌸 again to complete the setting.
- ▶ Once set, 🌸 will appear on the screen.



How can I take better close-ups?

In macro shooting, try attaching the camera to a tripod and shooting in 🔄 to prevent the camera from moving and blurring the image (p. 59).



🌸 will turn gray in the area that displays in the yellow bar underneath the zoom bar, and the camera will not focus.

Shooting Far Away Subjects (Infinity)

When it is difficult to focus because your shot contains subjects that are both near and far, you can change the focusing range to focus more reliably on far away subjects (approx. 3 m (9.8 ft.) or more from the camera) only.

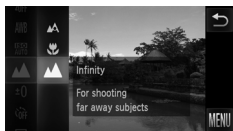

Choose 🏔️.



- Touch **FUNC.**, then drag up or down the menu on the left to choose 🏔️.
- Touch 🏔️, then touch 🏔️ again to complete the setting.
- ▶ Once set, 🏔️ will appear on the screen.

Changing the AF Frame Mode

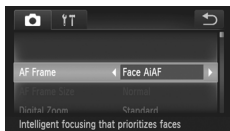
You can change the AF (Auto Focus) frame mode to match the scene you want to shoot.



Choose [AF Frame].

- Touch **FUNC.**, then **MENU** to choose the  tab. Touch [AF Frame], then touch   to choose an option.

Face AiAF

- Detects people's faces and sets the focus, exposure (evaluative metering only) and white balance (AWB only).
- When the camera is pointed at subjects, a white frame appears on the face the camera judges to be the main subject, and gray frames (max. 2) will appear on other faces.
- A frame will follow a moving subject within a certain range.
- When the shutter button is pressed halfway, up to 9 green frames will appear on faces that the camera focuses on.



- If a face is not detected and only gray frames (no white frame) appear, up to 9 green frames will appear on the areas the camera focuses on when the shutter button is pressed halfway.
- If a face is not detected when Servo AF (p. 100) is set to [On], the AF frame will appear in the center of the screen when you press the shutter button halfway.
- Examples of faces that cannot be detected:
 - Subjects that are far away or extremely close
 - Subjects that are dark or light
 - Faces turned to the side or at an angle, or faces with a portion hidden
- The camera may mistakenly identify non-human subjects as a face.
- If the camera cannot focus when you press the shutter button halfway, the AF frame will not appear.

Fixed Frame

A single AF frame will be used. This is effective for focusing on a specific point.



You can reduce the AF frame size

- Touch **FUNC.**, then **MENU** to choose the  tab, then touch [AF Frame Size] and choose [Small].
- The AF frame is set to [Normal] when using the digital zoom (p. 55) or digital tele-converter (p. 56).



If the camera cannot focus when you press the shutter button halfway, the AF frame will turn yellow and  will appear.

Changing the Composition with the Focus Lock

While you keep the shutter button pressed halfway, the focus and exposure are locked. You can now recompose and shoot. This is called Focus Lock.



1 Focus.

- Center the subject you want in focus, and press the shutter button halfway.
- Confirm that the AF frame on the subject is green.



2 Recompose.

- Keep the shutter button pressed halfway and move the camera to recompose the scene.

3 Shoot.



- Press the shutter button fully.

Magnifying the Focal Point

If you press the shutter button halfway, the AF frame will magnify and you can check the focus.



1 Choose [AF-Point Zoom].

- Touch **FUNC.**, then **MENU** to choose the  tab. Touch [AF-Point Zoom], then touch   to choose [On].



2 Check the focus.

- Press the shutter button halfway.
- ▶ In [Face AiAF] (p. 95), the face detected as the main subject will appear magnified.
- ▶ In [Fixed frame] (p. 96), the contents of the AF frame will appear magnified.



What if the display does not magnify?

The display will not appear magnified in [Face AiAF] if a face cannot be detected or is too big in relation to the screen. In [Fixed frame], it will not appear magnified if the camera cannot focus.



The magnified display will not appear when using the digital zoom (p. 55), digital tele-converter (p. 56) or Servo AF (p. 100).

Choosing the Subject to Focus On (Touch AF)

You can choose a specific subject or person's face, or a location on the screen, to focus on and shoot.



1 Choose the subject, face or location to focus on.

- Touch the subject or person shown on the screen.



- ▶ When the AF frame mode is set to [Face AiAF], the camera will beep and display  when it detects the subject. The camera will continue to focus even if the subject moves.



- ▶ When the AF frame mode is set to [Fixed frame], an AF frame will appear at the location where you touch the screen.
- To cancel, touch .



2 Shot.

- Press the shutter button halfway. The frame where the camera focused will change into a green .
- Press the shutter button fully to shoot.



- The camera may not be able to track the subject if the subject is too small, moves too quickly or if the contrast between the subject and the background is too low.
- When shooting in  or  (p. 94) with the AF frame mode set to [Face AiAF], choosing a location to focus on returns the camera to .



A border appeared around the screen when it was touched

Touch operations on faces or subjects appearing outside the border will not work. They will work if the face or subject move inside the border.

Shooting with the AF Lock

The focus can be locked. After locking the focus, the focal distance will not change even when you release your finger from the shutter button.



1 Lock the focus.

- Keep the shutter button pressed halfway and touch inside the frame shown on the left.
- ▶ The focus locks and AFL appears on the screen.
- If you release your finger from the shutter button and touch the screen again, AF lock will cancel, and AFL will disappear.





2 Compose the scene and shoot.

Shooting with Servo AF

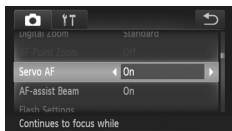
While the shutter button is pressed halfway, the focus and exposure will continue to adjust, allowing you to take pictures of moving subjects without missing a shot.



1 Choose [Servo AF].

- Touch **FUNC.**, then **MENU** and choose the  tab and touch [Servo AF], then touch  to choose [On].

2 Focus.

- The focus and exposure will be maintained where the blue AF frame appears while you press the shutter button halfway.



- The camera may not be able to focus in some conditions.
- In low light conditions, AF frames may not turn blue even after pressing the shutter button halfway. In this case, you can set the focus and exposure with the AF frame setting.
- If a correct exposure cannot be obtained, the shutter speed and aperture value appear in orange. Release your finger from the shutter button, then press it again halfway.
- You cannot shoot with the AF lock in this mode.
- The [AF-Point Zoom] option in the  tab is not available in Servo AF mode.
- Not available when using the self-timer ([pp. 58, 59](#)).

Changing the Metering Method

You can change the metering method (brightness measuring function) to match the shooting conditions.





1 Choose the metering method.

- Touch **FUNC.**, then drag up or down the menu on the left to choose .

2 Choose an option.

- Touch an item you want to set.
- Touch the menu item again to complete the setting.
- ▶ The setting will appear on the screen.

 Evaluative	For standard shooting conditions, including back lit shots. Automatically adjusts the exposure to match the shooting conditions.
 Center Weighted Avg.	Averages the light metered from the entire frame, but gives greater weight to the center.
 Spot	Only meters within the [] (Spot AE Point frame) that appears at the center of the screen. When the AF frame mode is set to [Fixed frame], the Spot AE Point frame will be linked to the AF frame.

Shooting with the AE Lock

You can lock the exposure and shoot, or set the focus and exposure separately to shoot. AE stands for “Auto Exposure”.



1 Lock the exposure.

- Point the camera toward the subject and touch the lower part of the screen (inside the frame shown on the left) while pressing the shutter button halfway.
- ▶ When **AEL** appears, the exposure will be locked.
- If you release your finger from the shutter button and touch the screen again, **AEL** will cancel, and **AEL** will disappear.

2 Compose the scene and shoot.

Shooting with the FE Lock

Just as with the AE lock (p. 102), you can lock the exposure for shooting with the flash. FE stands for “Flash Exposure”.



1 Choose (p. 85).

2 Lock the flash exposure.

- Point the camera toward the subject and touch the lower part of the screen (inside the frame shown on the left) while pressing the shutter button halfway.
- ▶ The flash will fire and when **FEL** appears, the flash output will be retained.
- If you release your finger from the shutter button and touch the screen again, **FEL** will disappear.





3 Compose the scene and shoot.

Shooting with Slow Synchro

You can make the main subject, such as people, appear bright by having the camera provide the appropriate illumination with the flash. At the same time, you can use a slow shutter speed to brighten the background that the light from the flash cannot reach.



1 Choose .

- Touch , then touch .
- Touch  again to make the setting.
- ▶ Once set,  will appear on the screen.

2 Shoot.

- Even if the flash fires, ensure that the main subject does not move until the shutter sound ends.



Attach the camera to a tripod to prevent the camera from moving and blurring the image. Additionally, you should set the [IS Mode] to [Off] when shooting with a tripod ([p. 173](#)).



You can also choose items by touching .

Red-Eye Correction

You can automatically correct red-eye that occurs in images taken with the flash.

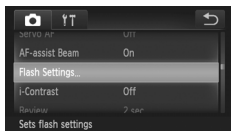

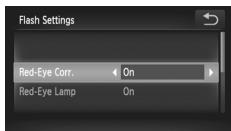

1 Choose [Flash Settings].

- Touch **FUNC.**, then **MENU** and choose the  tab and touch [Flash Settings].



2 Choose the setting.

- Touch [Red-Eye Corr.], then touch  to choose [On].
- ▶ Once set,  will appear on the screen.



Red-eye correction may be applied to areas other than red eyes. For example, when red make-up has been used around eyes.





You can also correct recorded images ([p. 150](#)).

Checking for Shut Eyes

When the camera detects the possibility that people have their eyes shut,  appears on the screen.





1 Choose [Blink Detection].

- Touch **FUNC.**, then **MENU** to choose the  tab. Touch [Blink Detection], then touch  to choose [On].

2 Shoot.

- ▶ When a person with shut eyes is detected, a frame and  appear on the screen.



- This function is only available for the last image shot when you have set the camera to 2 or more shots in  or  mode.
- Not available in  mode.



6

Getting More Out of Your Camera

This chapter explains how to shoot in **Tv** and **Av** modes.

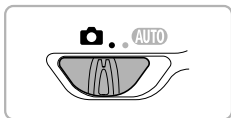

Setting the Shutter Speed

You can set the shutter to the speed at which you want to shoot. The camera will set the appropriate aperture value for the shutter speed you set.

Tv stands for “Time value”.



1 Choose a Shooting mode.

- Follow Steps 1 – 2 on [p. 64](#) to choose **Tv**.

2 Adjust the setting.

- Touch the [1/125].
- Touch the bar, or drag it left or right, to choose a shutter speed, then touch ↶.

3 Shoot.

Available Shutter Speeds

15", 13", 10", 8", 6", 5", 4", 3"2, 2"5, 2", 1"6, 1"3, 1", 0"8, 0"6, 0"5, 0"4, 0"3, 1/4, 1/5, 1/6, 1/8, 1/10, 1/13, 1/15, 1/20, 1/25, 1/30, 1/40, 1/50, 1/60, 1/80, 1/100, 1/125, 1/160, 1/200, 1/250, 1/320, 1/400, 1/500, 1/640, 1/800, 1/1000

- 2" indicates 2 seconds, 0"3 indicates 0.3 second and 1/160 indicates 1/160 second.
- Depending on the zoom position, some shutter speeds may not be available.



- When shutter speeds of 1.3 seconds or slower are used, images are processed to eliminate noise after being taken. A certain amount of processing time may be needed before you can take the next shot.
- You should set the [IS Mode] to [Off] when lowering the shutter speed and shooting with a tripod ([p. 173](#)).
- When shutter speeds of 1.3 seconds or slower are used, the ISO speed is fixed to $\frac{150}{100}$.

? What if the aperture value appears in orange?

If the aperture value appears in orange when the shutter button is pressed halfway, the scene has exceeded the correct exposure limits. Adjust the shutter speed until the aperture value appears in white (Safety shift can also be used (p. 110)).

Setting the Aperture Value

You can set the aperture to a value at which you want to shoot. The camera will set the appropriate shutter speed for the aperture value you set.

Av stands for “Aperture value”, which refers to the size of the aperture opening inside the lens.



1 Choose a Shooting mode.

- Follow Steps 1 – 2 on p. 64 to choose **Av**.

2 Adjust the setting.

- Touch [F4.0].
- Touch the bar, or drag it left or right, to choose an aperture value, then touch ↶.

3 Shoot.

Available Aperture Values

F2.0, F2.2, F2.5, F2.8, F3.2, F3.5, F4.0, F4.5, F5.0, F5.6, F5.8, F6.3, F7.1, F8.0

- Depending on the zoom position, some aperture values may not be available.

What if the shutter speed appears in orange?

If the shutter speed appears in orange when the shutter button is pressed halfway, the scene has exceeded the correct exposure limits. Adjust the aperture value until the shutter speed appears in white. Safety shift can also be used (see below).

Safety Shift



In **Tv** and **Av**, if you touch **FUNC.** or **MENU** side to display the  tab, and set [Safety Shift] to [On], the shutter speed or aperture value is automatically adjusted for the correct exposure when it cannot otherwise be obtained. Safety Shift is disabled when the flash is enabled.

7

Using Various Functions for Shooting Movies

This chapter serves as a more advanced version of the “Shooting Movies” and “Viewing Movies” sections in Chapter 1, and explains how to use various functions for shooting and viewing movies.



- This chapter assumes that you have set the mode switch to .
- The latter half of the chapter explaining movie playback and editing assumes that you have pressed the  button to enter Playback mode.

Shooting Various Kinds of Movies



Just as with still images, you can let the camera select the best settings for the scene or add various effects while shooting movies.













1 Choose a Shooting mode.

- Follow Steps 1 – 2 on [p. 64](#) to choose a Shooting mode.



2 Shoot.



- Touch .
- ▶ Depending on the Shooting mode or movie image quality ([p. 116](#)) you choose, black bars may appear on the sides of the screen. These areas will not be recorded when shooting.
- To stop shooting the movie, touch .

 Portrait	p. 64
 Miniature Effect	p. 113
 Monochrome	p. 74
 Super Vivid	p. 68
 Poster Effect	p. 68
 Color Accent	p. 72

 Color Swap	p. 73
 Beach	p. 65
 Foliage	p. 65
 Snow	p. 66
 Fireworks	p. 66

Other Shooting Modes



You can shoot the following kinds of movies in  and  modes.

 iFrame Movie	Shoots movies that can be edited with iFrame ^{*1} compatible software ^{*2} or devices. Recording pixels are fixed to  (p. 116).
 Super Slow Motion Movie	Shoot fast moving subjects and play them back in slow motion (p. 114).

*1 Video type advocated by Apple.

*2 You can quickly edit and save iFrame movies with version 6.7.2 or later of ZoomBrowser EX or ImageBrowser. If you are using an earlier version of the software, download the latest version from the Canon home page. You can check the version of the included software on the top of the CD-ROM ([p. 2](#)).



- You can also record movies in other Shooting modes by touching .
- Certain settings made in the FUNC. and Shooting menus will automatically change to match settings for shooting movies.
- Even in  or  mode, you can shoot still images when you press the shutter button. However, this is not possible while shooting a movie.

Shoot Movies That Look Like a Miniature Model (Miniature Effect)





You can shoot movies that look like moving miniature models. You create the miniature model effect by choosing the upper and lower portions of the scene that will be blurred, and the playback speed, which makes people and objects in the scene move quickly during playback. Audio will not be recorded.

1 Choose .

- Follow Steps 1 – 2 on [p. 64](#) to choose .
- ▶ A white frame (the area that will not be blurred) appears on the screen.



2 Choose the area to keep in focus.

- Touch the screen to change the area to keep in focus.
- Touch , then touch ,  or  to change the size of the focused area and touch .



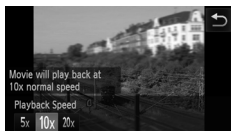

3 Choose a playback speed.

- Touch **10x**, then touch **5x**, **10x** or **20x** to choose a playback speed and touch .





4 Shoot.

- Touch .
- To stop shooting the movie, touch .

Playback Speeds and Estimated Playback Times (for 1 Min. Clips)

Speed	Playback Time
5x	Approx. 12 sec.
10x	Approx. 6 sec.
20x	Approx. 3 sec.



- The image quality will be fixed at 1640 when an aspect ratio of 4:3 is chosen, and 1280 when an aspect ratio of 16:9 is chosen (p. 90).
- If you touch  in Step 2, the frame will switch to vertical orientation and you can change the area to keep in focus by touching the screen. Touch  again to return the frame orientation to horizontal.
- Holding the camera vertically will change the orientation of the frame.
- Since you may not achieve the expected results depending on the shooting conditions, try taking some test shots first.

Shooting Super Slow Motion Movies

You can shoot fast moving subjects and play them back in slow motion. Audio will not be recorded.

1 Choose .

- Follow Steps 1 – 2 on p. 64 to choose .

2 Choose a frame rate.

- After touching FUNC., drag the menu appearing on the left side of the screen up or down to choose , then touch the menu item again.
- Choose a frame rate (the number of frames per second), then touch the menu item again.

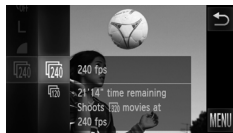



3 Shoot.

- Touch ●.
- ▶ The bar showing the shooting time will appear. Maximum clip length is approx. 30 sec.
- To stop shooting the movie, touch ■.

Frame Rates and Playback Times (for 30 Sec. Clips)

Frame Rate	Playback Time
$\overline{240}$ 240 fps	Approx. 4 min.
$\overline{120}$ 120 fps	Approx. 2 min.



Viewing super slow motion movies

- The movie will play back in slow motion when you follow Steps 1 – 3 on p. 33.
- You can use the included software to change the playback speed of movies shot in  mode. Refer to the *Software Guide* for details.



- The recording pixel setting will be fixed at $\overline{320}$ when shooting in $\overline{240}$, and $\overline{640}$ when shooting in $\overline{120}$.
- The focus, exposure and white balance will be set when you touch ●.

Changing the Image Quality

You can choose among 4 different image quality settings.



1 Choose the image quality setting.

- Touch **FUNC.**, then drag up or down the menu on the left to choose **1920**.

2 Choose an option.

- Touch an item you want to set.
- Touch the menu item again to complete the setting.
- ▶ The option you set will appear on the screen.

Image Quality and Shooting Time per Memory Card

Image Quality	Recording Pixels, Frame Rate	Content	Memory Card Capacity	
			4 GB	16 GB
1920	1920 x 1080 pixels, 24 frames/sec.	For shooting full high-definition movies.	Approx. 14 min. 34 sec.	Approx. 59 min. 40 sec.
1280	1280 x 720 pixels, 30 frames/sec.	For shooting high-definition movies.	Approx. 20 min. 43 sec.*1	Approx. 1 hr. 24 min. 54 sec.*2
640	640 x 480 pixels, 30 frames/sec.	The image quality will be higher when compared with 320 , but the recording time will be shorter.	Approx. 43 min. 43 sec.	Approx. 2 hr. 59 min. 3 sec.
320	320 x 240 pixels, 30 frames/sec.	Since the file size is small, shooting time will increase, but the image quality will decrease.	Approx. 1 hr. 58 min. 19 sec.	Approx. 8 hr. 4 min. 30 sec.

*1 13 min. 35 sec. for iFrame movies (p. 112).

*2 55 min. 38 sec. for iFrame movies (p. 112).

- Based on Canon's testing standards.
- Recording will automatically stop when the clip file size reaches 4 GB, or when the recording time reaches approximately 10 minutes when shooting in **1920** or **1280**, and approximately 1 hour when shooting in **640** or **320**.
- Recording may stop even if the maximum clip length has not been reached on some memory cards. SD Speed Class 6 or higher memory cards are recommended.



Black bars will appear on the sides of the screen in **640** or **320**. These areas will not be recorded when shooting.

Other Shooting Functions

The following functions can be used in the same way as for still images. Some functions, however, may not be available or may not have an effect depending on the Shooting mode.



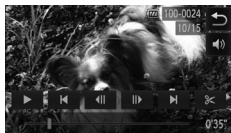

- **Zooming in More Closely On Subjects**
The sound of zoom operations will be recorded.
- **Using the Self-Timer (p. 58)**
- **Using the Self-Timer to Prevent Camera Shake (p. 59)**
- **Adjusting the White Balance (p. 86)**
- **Changing the Tone of an Image (My Colors) (p. 92)**
- **Shooting with the AF Lock (p. 99)**
- **Turning Off the AF Assist Beam (p. 171)**
- **Displaying Grid Lines (p. 172)**
- **Changing the IS-Mode Settings (p. 173)**
- **Changing Icon Order (Icon Layout) (p. 174)**

Editing



You can trim the beginnings and ends of recorded movies.



1 Choose .

- Touch the screen during movie playback to display the movie control panel.
- Touch ,  or the scroll bar to change the displayed frame (frames are the basic units that make up a movie).
- ▶  will change to  at points where you can edit the movie.

2 Touch or .

- ▶ [Delete section of movie] will appear on the screen.
- Even if you touch  when it appears, only the portion from the nearest  to the left will be trimmed when [Cut Beginning] is chosen. Only the portion from the nearest  to the right will be trimmed when [Cut End] is chosen.

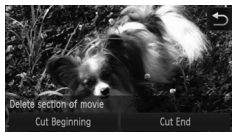

3 Choose a portion to delete.

- Touch [Cut Beginning] or [Cut End].
- [Cut Beginning] will delete from the beginning of the movie to the currently displayed scene.
- [Cut End] will delete from the currently displayed scene to the end of the movie.

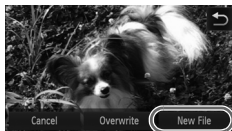

4 Save the edited movie.

- Touch [New File].
- ▶ The movie will be saved as a new file.
- To cancel editing, touch [Cancel].
- To reset the editing range, touch ↶.



- When [Overwrite] is chosen in Step 4, the unedited movie is overwritten with the edited movie, erasing the original.
- When there is not enough space left on the memory card, only [Overwrite] can be chosen.
- If the battery is depleted partway through saving, the edited movie clips may not be saved.
- When editing movies, you should use a fully charged battery, or an AC adapter kit (sold separately) (p. 39).

8

Using Various Playback and Editing Functions

This chapter explains various ways to play back and edit images.

- Press the  button to enter Playback mode before operating the camera.



- It may not be possible to play back or edit images that have been edited on a computer, have had their file names changed, or have been taken on a different camera.
- The edit function (pp. 145 – 150) cannot be used if the memory card does not have enough free space available.

Quickly Searching Images

Searching Images Using Index Display



Displaying multiple images at the same time lets you quickly find the image you want.

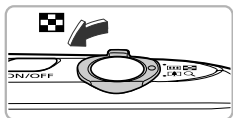

1 Display images in an index.

- After touching , touch the number of images you want to display.



- ▶ Images will display in an index.
- You can also move the zoom lever toward  to display images in an index. Move the zoom lever toward  to reduce the number of images.

2 Switch the displayed images.

- If you drag up or down the screen, images will switch with the movement of your finger.



3 Choose an image.

- Touch an image to choose it, then touch it again to display it in single image playback.
- You can also drag across the screen to move the orange frame, then move the zoom lever toward  to display an image by itself.

Searching Images by Scrolling

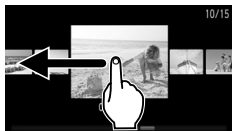

Dragging across the screen will display images in a line letting you quickly search them. You can also jump by the shooting date (Scroll Display).



Choose an image.

- You can switch between images in single image playback by dragging across the screen.
Continuously dragging quickly across the screen will display the screen on the left (Scroll Display).
In this display, drag across the screen to choose images.
- Touching the center image restores single image playback.
- While in Scroll Display, if you quickly drag up or down the screen, you can search images by the shooting date.



To turn off this effect, touch **FUNC.** and then **MENU.** Choose [Scroll Display] in the  tab, then touch  to choose [Off].

Viewing Movies Made with Movie Digest

You can select movies made in  mode (p. 67) by date for viewing.

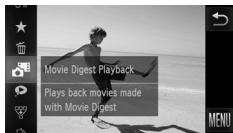

1 Choose .

- After touching **FUNC.**, drag the menu appearing on the left side of the screen up or down to choose , then touch the menu item again.

2 Choose a movie date.

- Touch a date to choose it.

3 Play the movie.

- Touch the date chosen in Step 2.
- ▶ The movie will play.

Viewing Images in Filtered Playback

When there are many images on the memory card, you can filter and display them by a specified filter. You can also protect (p. 137) or delete (p. 139) all images at once while filtered.

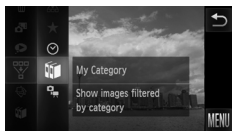

1 Choose .



- Touch **FUNC.**, then drag up or down the menu to the left to choose .

2 Choose a filter.





- Touch an item you want to set.
- If you drag up or down the menu on the right, other items will appear.
- Touch the item you chose again to complete the setting.



3 View the filtered images.

- Touch the desired filter, then touch it again (except for ).
- ▶ Filtered playback starts and a yellow frame appears.
- If you drag across the screen, only the chosen target images will display.
- If you choose  in Step 2, filtered playback will be canceled.

Search filters

 Favorites	Displays the images tagged as favorites (p. 141)
 Shot Date	Displays the images shot on a specified date
 My Category	Displays the images of a specified category (p. 143)
 Still image/Movie	Displays still images, movies or movies made in  mode.



What if you cannot choose a filter?

Filters that do not have any corresponding images cannot be chosen.



Filtered playback

In filtered playback (Step 3), you can view filtered images with “Quickly Searching Images” (p. 120), “Viewing Slideshows” (p. 124), and “Magnifying Images” (p. 127). You can process all filtered images at once while performing operations in “Protecting Images” (p. 137), “Erasing All Images” (p. 139), or “Choosing Images for Printing (DPOF)” (p. 159), by choosing all of the filtered images. However, if you change the category (p. 143), or edit an image and save it as a new image (p. 145), a message will appear, and filtered playback will cancel.

Viewing Slideshows

You can automatically play back images recorded to a memory card. Each image displays for approximately 3 seconds.

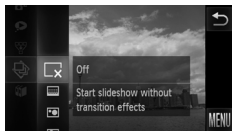

1 Choose .

- After touching **FUNC.**, drag the menu appearing on the left side of the screen up or down to choose , then touch the menu item again.

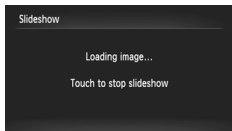

2 Choose a transition effect.

- Touch an effect to choose it.
- Touch the menu item again to complete the setting.
- ▶ The slideshow will start a few seconds after [Loading image...] appears.
- In filtered playback (p. 123), only images matching a filter play back.
- Touch the screen to stop the slideshow.



- You can switch images if you lightly tap the camera (p. 29) during a slideshow (Active Display).
- The power saving function (p. 52) does not work during slideshows.
- You can also use Touch Actions to start a slideshow (p. 131).

Changing Settings

You can set a slideshow to repeat, or change transition effects and the time that slideshow images are displayed. You can choose from 6 transition effects when switching between images.

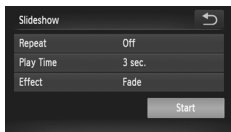

1 Choose [Slideshow].

- Touch **FUNC.**, then **MENU** to choose the  tab, and touch [Slideshow].

2 Choose a setting.

- Touch an item, then touch  to make the setting.
- If you touch [Start], the slideshow starts with your settings.
- Touching the screen during playback will restore the menu screen.



You cannot change [Play Time] if [Bubble] is chosen in [Effect].

Checking the Focus

You can magnify the area of a recorded image that was inside the AF Frame to check the focus.



1 Touch DISP. to switch the focus check display (p. 44).

- ▶ A white frame will appear where the AF frame was when the focus was set.
- ▶ A gray frame will appear on a face detected during playback.
- ▶ The area within the orange frame appears magnified.



2 Switch frames.

- Touch the lower right image, or move the zoom lever toward Q once.
- ▶ The screen shown on the left will appear.
- Touch □→□ to move to a different frame when multiple frames appear.

3 Change the magnification level or location.

- Moving the zoom lever, or touching the magnified image on the lower right of the screen, or Ⓚ Ⓛ will change the displayed magnification rate.
- If you drag across the image on the lower right, you can move the location of the displayed area.
- Touching ↶, or the image in the upper left resets the display to Step 1.



The focus check display is not available for movies.

Magnifying Images



Approximate Location of Displayed Area

Magnify an image.

- When you touch the screen, the image will magnify and and will appear.
- If you keep your finger on the screen, the display will continue to zoom on that part of the image up to a factor of 10x.
- You can also zoom in or out on images by touching or . If you touch and hold or , the display will continue zoom in or out on the image.
- If you drag across the screen, you can move the location of the displayed area.
- Touch to restore single image playback.
- You can also tap the side of the camera gently (p. 29) to switch between images at the same zoom factor (Active Display).





- If you move the zoom lever toward , the display will zoom in on the image and, if you continue to hold the zoom lever, it will continue to zoom in up to a maximum factor of 10x. To zoom out, move the zoom lever toward , or continue to hold it to return to single image playback.
- Movies cannot be magnified.

Viewing Each Image in a Group

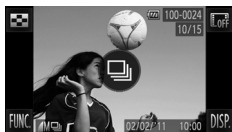
Grouped images taken in  mode (p. 80) can also be viewed individually.



1 Choose an image group.

- Drag left or right across the screen to choose an image that displays , then touch .



2 View each image in the group.

- If you drag left or right across the screen only the images in the group will be displayed.
- Touch  to exit group playback.



Group playback

In group playback (Step 2 above), you can use the FUNC. menu functions that appear when you touch FUNC., as well as search (p. 120) and magnify (p. 127) images. You can process all the images in a group at once while performing operations in “Protecting Images” (p. 137), “Erasing All Images” (p. 139), or “Choosing Images for Printing (DPOF)” (p. 159), by choosing a set of grouped images.

Ungrouping Images

Grouped images taken in  mode can be ungrouped and viewed individually.

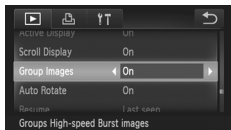



1 Choose [Group Images].

- Touch **FUNC.**, and then **MENU** to choose [Group Images] in the  tab.



2 Choose a setting.

- Touch  to choose [Off].
- Touch  to complete the setting and restore single image playback.
- ▶ Grouped images taken in  mode are ungrouped and appear individually.
- To regroup the images, follow the steps above and select [On].



Grouping cannot be canceled while viewing images individually (p. 128).

Displaying Various Images (Smart Shuffle)

The camera will choose four images based on the displayed image. If you choose one of those images, the camera will select four more images letting you enjoy playing back images in an unexpected order. This will work best if you take many shots of various scenes.

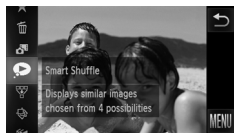

1 Choose .

- Touch **FUNC.**, then drag up or down the screen to choose .
- ▶ Four images will appear as possibilities.



2 Choose an image.

- Touch the image you want to view next.
- ▶ The chosen image will be displayed in the middle, and the next four possibilities will appear.
- If you touch the image in the center of the screen, it will display full-screen. Touch the screen to restore the original display.
- Touch  to return to single image view.



- Only still images shot with this camera will play back in Smart Shuffle.
-  is not available in the following situations:
 - If there are less than 50 images taken with this camera on the memory card
 - If you play back images not supported by Smart Shuffle
 - During filtered playback

Changing Image Transitions

You can choose from 3 transition effects when switching between images in single image playback.

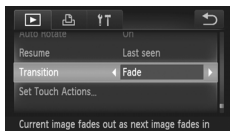

Choose [Transition].

- Touch **FUNC.**, and then **MENU** to choose [Transition] in the **▶** tab, then touch **◀▶** to choose an effect.

Easy Operations with Touch Actions

In single image playback, you can quickly and easily call up functions that have been registered to each of four set dragging patterns (Touch Actions).

Use a Function Registered to **↶**



- Drag across the screen as shown.
- ▶ The function registered to **↶** will be called up.



- By dragging across the screen as shown, you can also call up the functions registered to **↷**, **↵** and **↴**.
- You can change the functions registered to Touch Actions.

Changing Touch Actions Registered Functions

You can register the functions you want to use easily to each of the drag patterns.

1 Choose [Set Touch Actions].

- Touch **FUNC.**, then **MENU** to choose the  tab, and touch [Set Touch Actions].

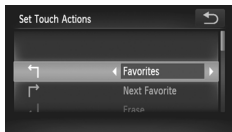

2 Register a function to a drag pattern.

- Drag up or down the screen to choose a drag pattern.
- Touch  to choose the function to register.

Functions that Can be Registered

Favorites	Tag or untag images as favorites.
Next Favorite	Switch to the next image tagged as a favorite
Previous Favorite	Switch to the previous image tagged as a favorite.
Next Date	Switch to first image with the next shooting date.
Previous Date	Switch to first image with the previous shooting date.
Smart Shuffle	Start Smart Shuffle playback.
Slideshow	View a slideshow.
Erase	Erase an image.
Protect	Protect or unlock images.
Rotate	Rotate an image.

Viewing Images on a TV

You can connect the camera to a TV to view images you have shot.



The following functions are available when you perform operations with the camera:

- Switching images
Drag across the screen, or tap the camera lightly with your finger (pp. 28, 29).
- Movie playback (p. 33)
- Magnification (p. 127)
Move the zoom lever toward Q.
- Group playback (p. 128)
- Touch Actions (p. 131)
Smart Shuffle and image erase cannot be called up.
Since nothing will appear on the camera's screen, look at the TV while using the camera screen to perform operations.

Viewing Images on a Standard TV

Using the supplied stereo AV cable (p. 2), you can connect the camera to a TV and control the camera.

1 Turn off the camera and TV.

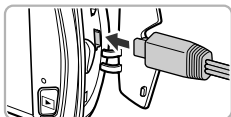

2 Connect the camera to the TV.

- Open the camera's terminal cover and fully insert the cable plug into the camera's terminal.
- Insert the cable plug fully into the video input terminals as shown in the illustration.

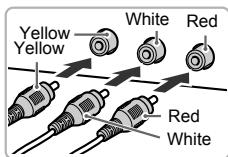

3 Turn on the TV and switch it to the input the cable is connected to.



4 Turn on the camera.

- Press the  button to turn on the camera.
- ▶ The image will appear on the TV (nothing will appear on the screen of the camera).
- Use the camera screen to perform operations.
- After you finish, turn off the camera and TV, and unplug the cable.

? What if the images don't display correctly on the TV?

Images will not display correctly if the camera's video output setting (NTSC/PAL) does not match the TV system. Touch **FUNC.**, then **MENU** to choose the  tab, then choose [Video System] to switch to the correct video system.

Viewing Images on a High-Definition TV

Using the separately sold HDMI Cable HTC-100, you can connect the camera to an HD TV and control the camera.

1 Turn off the camera and TV.

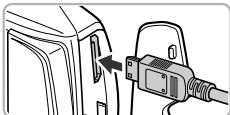

2 Connect the camera to the TV.

- Open the camera's terminal cover and fully insert the cable plug into the camera's terminal.
- Fully insert the cable plug into the TV's HDMI input.

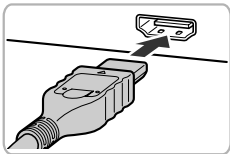

3 Display images.

- Follow Steps 3 and 4 on [p. 133](#) to display the images.



Operation sounds will not play when connected to an HD TV.

Using a TV Remote to Control the Camera

When you connect the camera to an HDMI CEC compatible TV, you can use the TV's remote control to operate the camera and play back images or view slideshows.

You may need to make settings on some TVs. For details, refer to the user guide supplied with the TV.

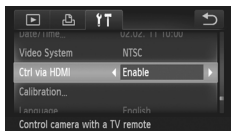

1 Choose [Ctrl via HDMI].

- Touch **FUNC.** and then **MENU** to choose [Ctrl via HDMI] in the **YT** tab, then touch **◀▶** to choose [Enable].

2 Connect the camera to the TV.

- Follow Steps 1 – 2 on [p. 134](#) to connect the camera to the TV.





3 Display images.

- Turn on the TV and press the camera's **▶** button.
- ▶ The image will appear on the TV (nothing will appear on the screen of the camera).

4 Use the TV's remote control.

- Press the remote control's **◀▶** buttons to choose an image.
- Press the OK/Select button to display the camera control panel. Press the **◀▶** buttons to choose an item, then press the OK/Select button again.

Summary of the Camera Control Panel Displayed on the TV

	Return	Closes the menu.
	Group playback	Displays groups of High-speed Burst images (only appears when grouped images are chosen).
	Play movie	Plays a movie (only appears when a movie is chosen).
	Slideshow	Plays back images automatically. During playback, you can press the remote control's ◀▶ buttons to switch images.
	Index playback	Displays images in an index.



- If you move the zoom lever and change the display, you will not be able to control the camera with the TV's remote control unit you return to single image playback.
- Some TVs may not be able to control the camera properly even though they are HDMI CEC compatible.

Protecting Images

You can protect important images so that they cannot be accidentally erased with the camera (pp. 30, 139).

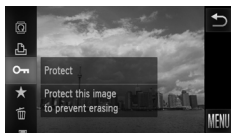

Protect the image.

- Touch **FUNC.**, then drag up or down the menu to the left to choose **Protect**.
- ▶ Once set, **Protect** will appear on the screen.
- To unlock an image, touch **FUNC.** again, then drag up or down the screen to choose **Protect**.



If you format the memory card (pp. 23, 165), protected images will also be erased.



Protected images cannot be erased with the camera's erase function. To erase an image, cancel protection settings first.

Using the Menu

1 Choose [Protect].

- Touch **FUNC.**, then **MENU** to choose the **Protect** tab, and touch [Protect].

2 Choose a selection method.

- Touch a selection method.
- Touch **Protect** to return to the menu screen.

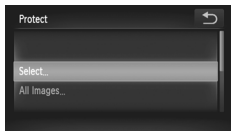

Choosing Images Individually

1 Choose [Select].

- Follow Step 2 on [p. 137](#) to touch [Select].



2 Choose images.

- Drag on the screen to choose an image, then touch the screen.
- ▶ Once set, ✓ will appear on the screen.
- Touching the screen again deselects the image, and ✓ disappears.
- To choose multiple images, repeat the above operation.

3 Protect the image.

- If you touch ↶, a confirmation screen will appear.
- Touch [OK].
- ▶ The images will be protected.

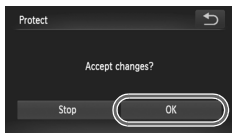

If you switch to Shooting mode or turn off the power before performing the operations in Step 3, images will not be protected.



To choose multiple images, touch  in the upper left of the screen and touch the images you want.

Choose All Images

1 Choose [All Images].

- Follow Step 2 on [p. 137](#) to touch [All Images].

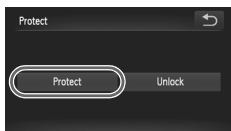

2 Protect images.

- Touch [Protect].



You can unlock groups of protected images if you choose [Unlock] in Step 2.

Erasing All Images

You can choose images and then erase them in groups. Since erased images cannot be recovered, exercise adequate caution before erasing. Protected images ([p. 137](#)) cannot be erased.

Choose a Selection Method

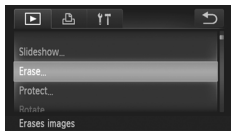

1 Choose [Erase].

- Touch FUNC., then MENU to choose the  tab, and touch [Erase].

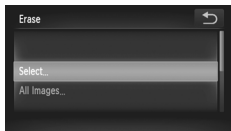

2 Choose a selection method.

- Touch a selection method.
- Touch  to return to the menu screen.

Choosing Images Individually



1 Choose [Select].

- Follow Step 2 on [p. 139](#), touch [Select].

2 Choose an image.

- Drag across the screen to choose an image, then touch the screen.
- ▶ Once set, ✓ will appear on the screen.
- Touching the screen again deselects the image, and ✓ disappears.
- To choose multiple images, repeat the above operation.

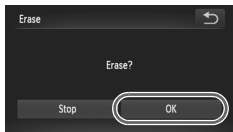

3 Erase.

- If you touch ↵, a confirmation screen will appear.
- Touch [OK].



To choose multiple images, touch  in the upper left of the screen and touch the images you want.

Choose All Images

1 Choose [All Images].

- Follow Step 2 on [p. 139](#), touch [All Images].

2 Erase.

- Touch [OK].

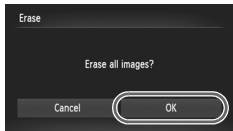

Tagging Images as Favorites

When you tag images as favorites, you can easily categorize just those images. You can also filter out just those images for viewing, protecting or erasing (p. 123).

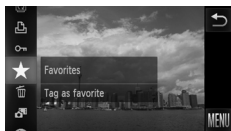

Make the setting.

- Touch **FUNC.**, then drag up or down the menu to the left to choose **★**.
- ▶ Once set, **★** will appear on the screen.
- To unlock an image, touch **FUNC.** again, then drag up or down the menu to the left to choose **★**.



Using the Menu

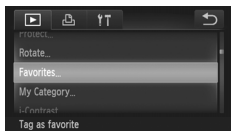

1 Choose [Favorites].

- Touch **FUNC.**, then **MENU** to choose the **▶** tab, and touch [Favorites].



2 Choose an image.

- Drag across the screen to choose an image, then touch the screen.
- ▶ Once set, **✓** will appear on the screen.
- Touching the screen again deselects the image and **✓** disappears.
- To choose multiple images, repeat the above operation.

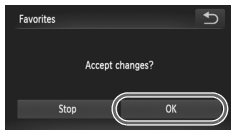

3 Complete the setting.

- If you touch ↶, a confirmation screen will appear.
- Touch [OK].



If you switch to Shooting mode or turn off the power before completing the setting in Step 3, images will not be tagged as favorites.



- If you use Windows 7 or Windows Vista and transfer tagged images to the computer, they will be given a star rating of 3 (★★★☆☆) (except for movies).
- You can also use Touch Actions to tag images as favorites (p. 131).
- To choose multiple images, touch  in the upper left of the screen and touch the images you want.

Organizing Images by Category (My Category)

You can organize images into categories. You can display the images in a category in filtered playback (p. 123) and process all images at once by using the functions below.

- “Viewing Slideshows” (p. 124), “Protecting Images” (p. 137), “Erasing All Images” (p. 139), “Choosing Images for Printing (DPOF)” (p. 159)



- Images are automatically categorized by shooting condition as they are shot.
 - : Images with detected faces, or images shot in or .
 - : Images detected as , or in **AUTO** mode, or images shot in , or .
 - : Images shot in , , .
- You can also display categories by touching **FUNC.** in Step 2, then choosing the tab, and [My Category].

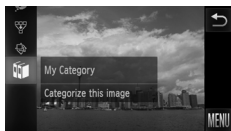

1 Choose .

- Touch **FUNC.**, then drag up or down the screen and touch .



2 Choose images.

- Drag left or right across the screen to choose an image.
- Touch the desired category.
 - ▶ The chosen category will appear in orange.
- Touch the category again to cancel, and it will turn white.
- To choose multiple images, repeat the above operation.

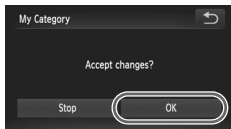

3 Complete the setting.

- If you touch , a confirmation screen will appear.
- Touch [OK].



If you switch to Shooting mode or turn off the power before completing the setting in Step 3, images will not be tagged as My Category.

Rotating Images

You can change the orientation of an image and save it.

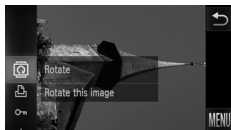



1 Choose .



- Touch **FUNC.**, then drag up or down the menu to the left to choose .



2 Rotate the image.

- Touch  or  and the image will rotate in the chosen direction in 90° increments.
- Touch  to accept the setting.



- Movies shot at  or  cannot be rotated.
- In the screen in Step 2, if you touch **FUNC.** then **MENU**, you can change the icon order by choosing the  tab and [Rotate].
- Images cannot be rotated (p. 176) if [Auto Rotate] is set to [Off].

Resizing Images

You can resize images to a lower pixel setting and save the resized image as a separate file.

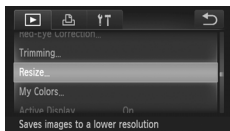

1 Choose [Resize].

- Touch **FUNC.**, then **MENU** to choose the  tab, and touch [Resize].

2 Choose an image.

- Drag across the screen to choose an image, then touch [OK].



3 Choose an image size.

- Touch **M2**, **S** or **XS**, then touch [OK].
 - ▶ [Save new image?] will appear on the screen.

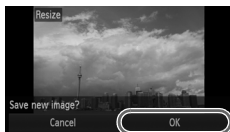

4 Save the new image.

- Touch [OK].
 - ▶ The image will be saved as a new file.



5 Display the new image.

- If you touch , [Display new image?] will appear.
- Touch [Yes].
 - ▶ The saved image will be displayed.



- You cannot resize an image to a larger size.
- Images saved as **XS** in Step 3 cannot be edited.
- Movies cannot be edited.

Trimming

You can cut out a portion of a recorded image and save it as a new image file.

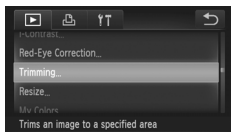

Trimming Area

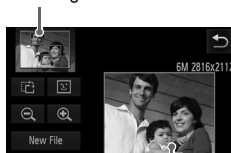

Trimming Area Display

Recorded pixels after trimming

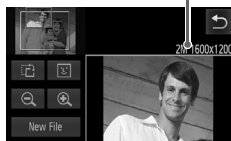





1 Choose [Trimming].

- Touch **FUNC.**, then **MENU** to choose the  tab, and touch [Trimming].

2 Choose an image.

- Drag across the screen to choose an image, then touch [OK].

3 Adjust the trimming area.

- ▶ A frame will appear around the portion of the image to be trimmed.
- ▶ The original image will display in the upper left and the trimmed image will display in the lower right.
- If you move the zoom lever, touch   or the image on the lower right of the screen, you can change the frame size.
- If you drag on the image at the upper left or the image on the lower right, you can move the frame.
- If you touch , you can change the frame orientation.
- In an image with detected faces, gray frames appear around the faces located in the upper left image. The frames can be used for trimming. You can switch between frames by touching .
- Touch [New File].
- ▶ The [Save new image?] screen will appear.

4 Save as a new image and display.

- Follow Steps 4 and 5 on [p. 145](#).



- Images recorded at a pixel setting of **S** (p. 61), or images resized to **XS** (p. 145) cannot be edited.
- Images that can be trimmed will have the same width and height ratio after trimming.
- The number of recorded pixels in a trimmed image will be smaller than before trimming.
- Movies cannot be edited.

Adding Effects with the My Colors Function

You can change the color of an image and save it as a separate image. Refer to [p. 92](#) for details on each menu item.

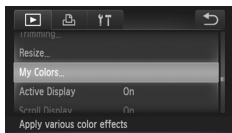

1 Choose [My Colors].

- Touch **FUNC.**, then **MENU** to choose the  tab, and touch [My Colors].

2 Choose an image.

- Drag across the screen to choose an image, then touch [OK].



3 Choose an option.

- Touch an option.
- Touch ◀▶ to display other available options.
- Touch [OK].
- ▶ The [Save new image?] screen will appear.

4 Save as a new image and display.

- Follow Steps 4 and 5 on [p. 145](#).



If you repeatedly change the color of the same image, the quality will gradually deteriorate and you may not achieve the expected color.



- The color of images changed with this function may vary from those recorded with the My Colors function ([p. 92](#)).
- My Colors settings cannot be applied to movies.

Correcting the Brightness (i-Contrast)

The camera can detect areas in an image, such as faces or backgrounds, that are too dark and automatically adjust them to the optimum brightness. Also, when the overall image is lacking in contrast, the camera will automatically correct the image for a sharper impression. You can choose from 4 levels of correction, and save the image as a new file.

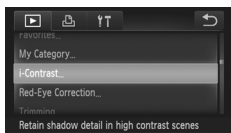

1 Choose [i-Contrast].



- Touch **FUNC.**, then **MENU** to choose the  tab, and touch [i-Contrast].

2 Choose an image.

- Drag across the screen to choose an image, then touch [OK].



3 Choose an option.

- Touch   to choose an item, and touch [OK].
- ▶ The [Save new image?] screen will appear.

4 Save as a new image and display.

- Follow Steps 4 and 5 on [p. 145](#).



- Under some conditions, the image may appear coarse or not be corrected properly.
- Repeatedly adjusting the same image may cause it to become coarse.



What if the image wasn't corrected by the [Auto] option as well as you would like?

Choose [Low], [Medium] or [High] and adjust the image.



Movies cannot be corrected.

Correcting the Red-Eye Effect

You can automatically correct red eyes in images and save them as new files.

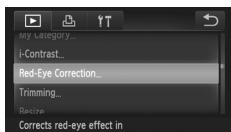

1 Choose [Red-Eye Correction].

- Touch **FUNC.**, then **MENU** to choose the  tab, and touch [Red-Eye Correction].

2 Choose and correct the image.

- Drag across the screen to choose an image, then touch [OK].
- ▶ Red-eye detected by the camera will be corrected and a frame will appear around the corrected portion.
- You can magnify or reduce the size of the image using the procedures in “Magnifying Images” (p. 127).



3 Save as a new image and display.

- Touch [New File].
- ▶ The image will be saved as a new file.
- Follow Step 5 on p. 145.



- Some images may not be corrected properly.
- When [Overwrite] in Step 3 is chosen, the uncorrected image is overwritten with the corrected data, erasing the original image.
- Protected images cannot be overwritten.



Movies cannot be corrected.

Printing

This chapter explains how to choose images for printing, and print using a Canon-brand PictBridge compliant printer (sold separately).

Canon-Brand PictBridge Compliant Printers

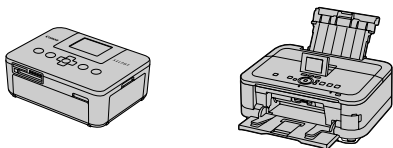

- This chapter uses Canon-brand SELPHY CP series printers in the explanations. The displayed screens and available functions will differ depending on the printer. Please also refer to the Printer User Guide.

Printing Images

Easy Print

You can easily print the pictures you take by connecting the camera to a PictBridge compliant printer (sold separately) using the supplied interface cable (p. 2).

1 Turn off the camera and printer.

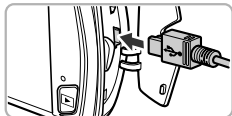

2 Connect the camera to the printer.

- Open the cover and insert the cable's small plug firmly into the camera terminal in the direction shown.
- Insert the cable's large plug into the printer. For connection details, refer to the user guide provided with the printer.

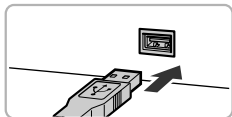

3 Turn on the printer.

4 Turn on the camera.

- Press the  button to turn on the camera.



5 Choose an image.

- Drag across the screen to choose an image.

6 Choose .

- Touch FUNC., then drag up or down the menu at the left to choose .

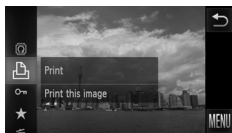



7 Print images.

- Touch [Print].
- ▶ Printing will start.
- If you want to print additional images, repeat Steps 5 and 6 after printing has completed.
- After printing has completed, turn off the camera and printer, and unplug the interface cable.



- Refer to [p. 40](#) for Canon-brand PictBridge compliant printers (sold separately).
- Index printing is not available on certain Canon-brand PictBridge compliant printers (sold separately).

Making Print Settings

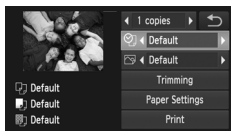

1 Connect the camera to the printer.

- Follow Steps 1 – 6 on [p. 152](#) to display the screen on the left.

2 Choose a menu option.

- Touch an item to choose it.

3 Choose the option settings.

- Touch ◀▶ to choose the option setting.

—	No. of Copies	Choose the number of copies.
📷	Default	Follows the printer's settings.
	Date	Prints the date.
	File No.	Prints the file number.
	Both	Prints both the date and file number.
	Off	—
🖼️	Default	Follows the printer's settings.
	Off	—
	On	Uses shooting information to optimize print settings.
	Red-Eye1	Corrects red-eye.
	Red-Eye2*	Uses [NR], [Face 🌟] and [Red-Eye1] to correct the image.
	Vivid*	Greens in trees, and blues in the sky and ocean are enhanced to be more vivid.
	NR*	Reduces image noise.
	Vivid+NR*	Uses both [Vivid] and [NR] to correct the image.
	Face 🌟*	Corrects brightness for dark faces, such as in backlit shots.
Trimming	—	Choose the area for printing.
Paper Settings	—	Sets the paper size and layout.

* Only appears when connected to Inkjet Printers.

Trimming and Printing (Trimming)

You can cut out a portion of an image for printing.

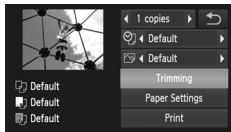

1 Choose [Trimming].

- Follow Steps 1 – 2 on [p. 154](#) to choose [Trimming].
- ▶ A frame will appear around the portion of the image to be trimmed.



2 Choose the trimming area.

- If you move the zoom lever, you can change the frame size.
- Drag the frame to change its position.
- Touch  to rotate the frame.
- Touch [OK] to complete the setting.

3 Print images.

- Follow Step 7 on [p. 153](#) to print.



- You may not be able to trim images depending on the aspect ratio, or if they are too small.
- Trimming photos with embedded dates may not show the dates properly.

Choosing the Paper Size and Layout for Printing

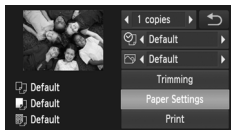

1 Choose [Paper Settings].

- Follow Steps 1 – 2 on [p. 154](#) to choose [Paper Settings].

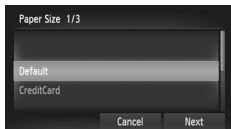

2 Choose a paper size.

- Touch an option to choose it, then touch [Next].

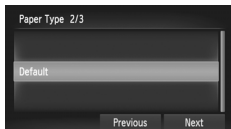

3 Choose the paper type.

- Touch an option to choose it, then touch [Next].

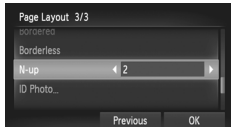

4 Choose the layout.

- Drag up or down the screen to choose a layout.
- Touch ◀▶ to set the number of prints when [N-up] is chosen.
- Touch [OK].

5 Print images.

Available Layout Options

Default	Follows the printer's settings.
Bordered	Prints with a border.
Borderless	Prints without a border.
N-up	Selects how many copies of an images are printed on a sheet.
ID Photo	Prints ID photos. Only images with the same resolution as the camera's L (Large) recording pixel setting and a 4:3 aspect ratio can be chosen.
Fixed Size	Choose the print size. Choose from 3.5 x 5 in., postcard and wide sized prints.

Printing ID Photos

1 Choose [ID Photo].

- Follow Steps 1 – 4 on [p. 156](#) to choose [ID Photo], then touch [Next].

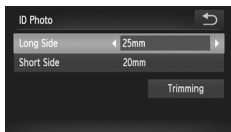

2 Choose the length and width.

- Touch an item to choose it.
- Touch ◀▶ to choose a length, then touch [Trimming].



3 Choose the printing area.

- Follow Step 2 on [p. 155](#) to choose the printing area.

4 Print images.

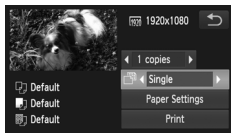

Printing Movies



1 Connect the camera to the printer.

- Follow Steps 1 – 6 on [p. 152](#) to choose a movie and display the screen on the left.

2 Choose a printing method.

- After touching , touch   to choose a printing method.

3 Print images.

Printing Methods for Movies

Single	Prints currently displayed scene as a still image.
Sequence	Prints a sequence of images from a specified scene on a single sheet of paper. If [Caption] is set to [On], you can print the folder number, file number, and the elapsed time for the frame at the same time.



- Touching [Stop] during printing will cancel printing.
- [ID Photo] and [Sequence] cannot be chosen on Canon brand PictBridge compliant printers from CP720/CP730 and earlier models.

Choosing Images for Printing (DPOF)

You can choose up to 998 images on a memory card for printing and specify settings such as the number of copies so that they can be printed together (p. 162) or processed at a photo developer service. These selection methods comply with the DPOF (Digital Print Order Format) standards.



Movies cannot be chosen.

Adding Images to a Print List with the FUNC. Menu

You can add images to the print list (DPOF) directly after shooting or during playback in the FUNC. menu.

1 Choose an image.

- Drag left or right across the screen to choose an image.

2 Choose (movies will be excluded).

- After touching FUNC., drag the menu appearing on the left side of the screen up or down to choose , then touch the menu item again.

3 Add images to the print list.

- Touch ▲▼ to choose the number of prints, then touch [Add].

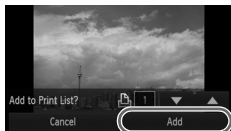

Print Settings

You can set the print type, date and file number. These settings apply to all images chosen for printing.

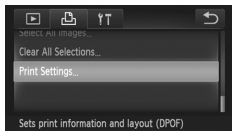

1 Choose [Print Settings].

- Touch **FUNC.**, then **MENU** to choose the  tab, and touch [Print Settings].

2 Choose a setting.

- Touch ▲▼ to choose and set an option.
- Once you touch , the settings will be made, and the menu screen will reappear.

Print Type	Standard	Prints 1 image per page.
	Index	Prints several reduced size images per page.
	Both	Prints both standard and index formats.
Date	On	Prints the shooting date.
	Off	—
File No.	On	Prints the file number.
	Off	—
Clear DPOF data	On	Removes all print settings after printing.
	Off	—



- Some printers or photo developer services may not be able to reflect all of the settings in the prints.
-  may appear when using a memory card with print settings set by a different camera. If you change the settings using this camera, all the previous settings may be overwritten.
- If [Date] is set to [On], some printers may print the date twice.



- With [Index] chosen, the [Date] and [File No.] options cannot be set to [On] at the same time.
- The date will be printed in the style set in the [Date/Time] function in the  tab (p. 20).

Choosing the Number of Copies

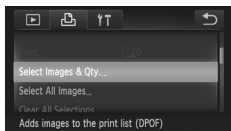

1 Choose [Select Images & Qty.].

- Touch FUNC., then MENU to choose the  tab, and touch [Select Images & Qty.].

2 Choose an image.

- Drag left or right across the screen to choose an image.
- ▶ You will be able to set the number of print copies.
- For [Index], touch the screen. Once chosen, ✓ will appear. If you touch inside the frame again, ✓ will disappear.



3 Set the number of prints.

- Touch ▲▼ to set the number of prints (maximum 99).
- Repeat Steps 2 and 3 to choose other images and the number of prints for each.
- You cannot set the number of copies for index prints. You can only choose which images to print (as shown in Step 2).
- Touch ↶ to complete the setting and return to the menu screen.

Set All Images to Print Once

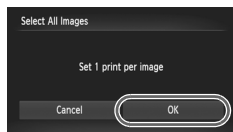

- 1 Choose [Select All Images].**
 - Follow Step 1 on [p. 161](#) to touch [Select All Images].
- 2 Make print settings.**
 - Touch [OK].

Clearing All Selections

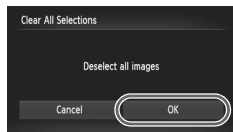

- 1 Choose [Clear All Selections].**
 - Follow Step 1 on [p. 161](#) to touch [Clear All Selections].
- 2 All selections will be cleared.**
 - Touch [OK].



Printing chosen images (DPOF)



- When there are images added to the print list ([pp. 159 – 162](#)), the screen on the left will appear when you connect the camera to a PictBridge compliant printer. Touch [Print now] to easily print images added to the print list.
- If you stop the printer during printing and start again, it will start from the next print.

10

Customizing Camera Settings

You can customize various settings to suit your shooting preferences. The first part of this chapter explains convenient and commonly used functions. The latter part explains how to change shooting and playback settings to suit your purposes.





Changing Camera Settings

You can customize convenient and commonly used functions from the  tab (p. 47).

Changing Sounds

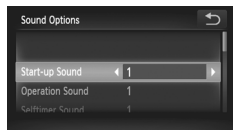
You can change each of the camera's operation sounds.



- Touch [Sound Options].
- Drag up or down the screen to choose an option, then touch   to choose a setting.

- | | |
|---|---|
| 1 | Preset sounds
(cannot be modified) |
| 2 | Preset sounds
You can use the included software to change the sounds (p. 2). |





Even if you change the shutter sound, it will have no effect in  (p. 80).

Turning Off Hints & Tips

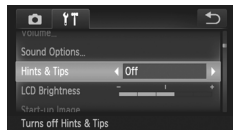
You can turn off this function. However, hints and tips for menus (p. 47) will always display.



- Choose [Hints & Tips], then touch   to choose [Off].

Low Level Memory Card Formatting

Perform low level formatting when [Memory card error] appears, the camera does not operate properly, you think that the recording/reading speed of a memory card has dropped, or recording suddenly stops while shooting a movie. As you cannot retrieve the erased data, exercise adequate caution before formatting the memory card.

1 Display the [Format] screen.

- Follow Steps 1 and 2 on [p. 23](#).

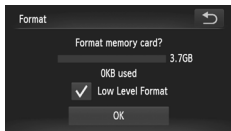

2 Start the low level format.

- Touch the frame to the left of [Low Level Format] to display a ✓.
- Touch [OK].
- ▶ A confirmation screen will appear.
- Touch [OK].
- ▶ Low level formatting starts.
- ▶ When low level formatting ends, [Memory card formatting complete] will appear on the screen.
- Touch [OK].



- Low level formatting may take longer than standard formatting ([p. 23](#)), since all recorded data is erased.
- You can stop a low level format of a memory card by touching [Stop]. When stopping low level formatting, the data will be erased but the memory card can be used without problem.

Changing the Start-up Screen

You can change the start-up screen that appears when you turn on the camera.

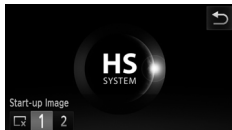



- Touch [Start-up Image].
- Touch an option.

<input type="checkbox"/>	No start-up image
1	Preset images (cannot be modified)
2	Preset images You can set recorded images, and use the included software to change the images.

Registering Recorded Images as the Start-up Screen

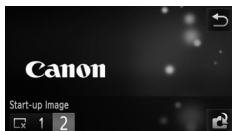
When you press the  button and set the camera to Playback mode, you can register an image.



- Touch [Start-up Image].
- Touch [2], then touch .



- Drag across the screen to choose an image, then touch [OK].
- ▶ The [Register?] screen will appear.
- Touch [OK].



Any previously registered start-up image will be overwritten when registering a new start-up image.



Register the start-up image or sounds with the included software

The dedicated operation sounds and start-up images on the included software can be registered to the camera. Refer to the *Software Guide* for details.

Changing the Screen Color

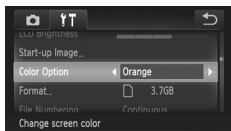

- Choose [Color Option], then touch ◀▶ to choose an option.

Changing the File Number Assignment

Images you shoot are automatically assigned file numbers in the order they were taken, from 0001 – 9999, and saved to folders of up to 2,000 images. You can change the file number assignment.

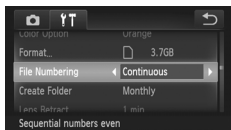

- Choose [File Numbering], then touch ◀▶ to choose an option.

Continuous	Even if you shoot using a new memory card, the file numbers are assigned consecutively until an image with the number 9999 is taken/saved.
Auto Reset	If you replace the memory card with a new one, or a new folder is created, file numbering begins with 0001 again.



- If you use a memory card already containing images, the newly assigned file numbers may continue the existing numbering for both [Continuous] and [Auto Reset]. If you want to start over with file number 0001, format the memory card before use (p. 23).
- Refer to the *Software Guide* for information regarding folder structure or image types.

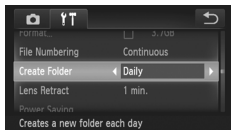

Creating Folders by Shooting Date

Images are saved into folders created each month, however, you can also create folders by shooting date.



- Choose [Create Folder], then touch ◀▶ to choose [Daily].
- Images will be saved into folders created on each shooting date.

Changing the Lens Retract Time

For safety reasons, the lens retracts about 1 minute after pressing the  button when in a Shooting mode (p. 28). If you want the lens to retract immediately when you press the , set the retract time to [0 sec.].

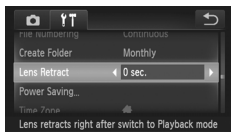

- Choose [Lens Retract], then touch ◀▶ to choose [0 sec.].

Turning Off the Power Saving Function

You can set the power saving function (p. 52) to [Off]. Setting it to [On] is recommended to save battery power.

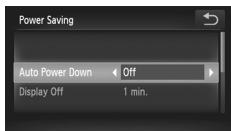

- Touch [Power Saving].
- Drag up or down the screen to choose [Auto Power Down], then touch ◀▶ to choose [Off].
- If you set the power saving function to [Off], be sure to turn the camera off after use.

Setting the Screen Shut-Off Time

You can adjust the time the screen takes to shut off automatically (p. 52). This also works when [Auto Power Down] is set to [Off].

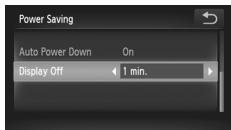

- Touch [Power Saving].
- Drag up or down the screen to choose [Display Off], then touch ◀▶ to choose a time.
- In order to save battery power, you should choose less than [1 min.].

Using the World Clock

When traveling abroad, you can record images with local dates and times simply by switching the time zone setting. If you pre-register the destination time zones, you can enjoy the convenience of not having to switch the Date/Time settings.

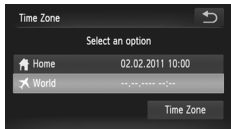
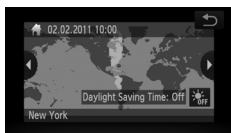
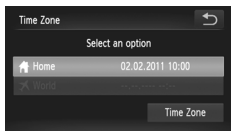

1 Set the home time zone.

- Touch [Time Zone].
- When setting this for the first time, check the information that displays on the screen on the left, then touch [Time Zone].
- Touch ◀▶ to choose the home time zone. Touch ☀ OFF to set daylight saving time (adds 1 hour).
- Touch ↶.

2 Set the world time zone.

- Touch [✈ World], then touch [Time Zone].
- Touch ◀▶ to choose the destination time zone.
- You can also set the daylight saving time as in Step 1.
- Touch ↶.

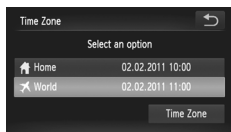

3 Choose the world time zone.

- Touch [World], then touch .
- ▶ will appear in the [Time Zone] or shooting screen (p. 187).



If you change the date or time in the setting (p. 20), your [Home] time and date will automatically change.

Calibrating the Touch Panel

You can calibrate the touch panel if you are having difficulty choosing items or buttons. Be sure to use the toggle attached to the strap to calibrate the touch panel accurately.

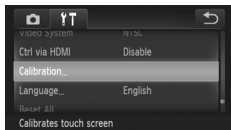

- Touch [Calibration].

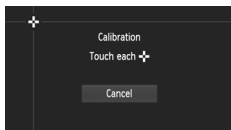



- Use the toggle attached to the strap to touch that appears on the screen (p. 14).
- Follow the on-screen instructions and touch the screen four times in the following order: in the upper left, lower left, lower right and upper right parts of the screen.



Only use the attached toggle to perform operations. Do not use other objects, such as pens or pencils.

Changing Shooting Function Settings

If you set the mode switch to , and the mode to **P**, you can change the settings in the  tab (p. 47).



Before attempting to shoot using a function explained in this section in modes other than **P**, check if the function is available in those modes (pp. 196 – 197).

Turning Off the AF Assist Beam

The lamp will automatically light to assist focusing in low light conditions when you press the shutter button halfway. You can turn off the lamp.

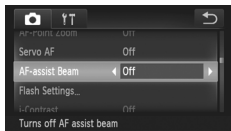



- Choose [AF-assist Beam], then touch   to choose [Off].

Turning Off the Red-Eye Reduction Function

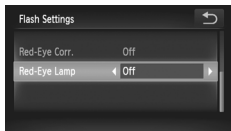
The red-eye reduction lamp lights in order to reduce the red-eye effect that occurs when shooting in dark conditions with the flash. You can turn off this function.



- Touch [Flash Settings].
- Drag up or down the screen to choose [Red-Eye Lamp], then touch   to choose [Off].

Changing the Image Display Time Right After Shooting

You can change the length of time the images display right after shooting.

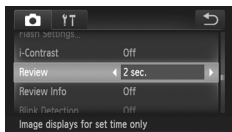

- Choose [Review], then touch ◀▶ to choose an option.

2 – 10 sec.	Displays images for the set time.
Hold	The image displays until you press the shutter button halfway.
Off	Images will not display.

Changing the Way the Image Displays Right After Shooting

You can change the way the image displays right after shooting.

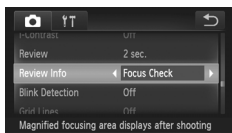

- Choose [Review Info], then touch ◀▶ to choose an option.

Off	Displays the image only.
Detailed	Displays detailed information (p. 189).
Focus Check	The area inside the AF frame is magnified, allowing you to check the focus. The procedure is the same as in “Checking the Focus” (p. 126).

Displaying Grid Lines

You can display grid lines on the screen for vertical and horizontal guidance while shooting.

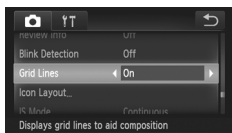

- Choose [Grid Lines], then touch ◀▶ to choose [On].



Grid lines will not be recorded on the image.

Changing the IS-Mode Settings

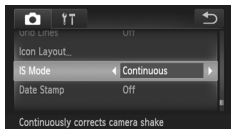

- Choose [IS Mode], then touch ◀▶ to choose an option.

Continuous	Image stabilization is always on. You can confirm the effects directly on the display, which makes it easier to check the composition or focus. When shooting movies, the camera also reduces strong camera shake, for example when walking (Dynamic mode).
Shoot Only*	Image stabilization is only active at the moment of shooting.
Panning*	Image stabilization only counters up and down motion. This option is recommended for shooting objects moving horizontally.
Off	—

* Setting changes to [Continuous] when shooting movies.



- If camera shake is too strong, attach the camera to a tripod. You should also set the IS Mode to [Off] when the camera is attached to a tripod.
- When using [Panning], hold the camera horizontally to shoot. Image stabilization does not work when the camera is held vertically.

Changing Icon Order (Icon Layout)

You can add icons to the shooting screen, or change their arrangement.

Adding Icons



1 Display the settings screen.

- In a shooting screen, touch and hold one of the icons.
- When [Changes which icons appear and their positions] appears, lift your finger off the screen once, then touch the center of the screen.
- ▶ The setting screen shown to the left will appear.

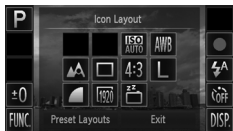

2 Add an icon.

- Drag the desired icon that appears in the center of the screen in Step 1 to the position you want.
- When you drag the icon near a position where it can be placed, an orange frame appears. Lift your finger off the screen to add the icon there. The icon will exchange places with any existing icon in that position.
- Positions with grayed out icons are unavailable.



3 Complete the setting.

- Touch [Exit].



If you have placed an icon in the upper right corner of the screen and then touch and hold that icon in Step 1, !▶ will appear and the layout screen will not be displayed. Choose a different icon instead.



Rearranging Icons



- Drag the desired icon that appears in the layout screen in Step 1 on p. 174 to the position you want.
- ▶ The icon will exchange places with any existing icon in that position.

Removing Icons



- When in the layout screen that appears in Step 1 on p. 174, drag the icon you want to remove to the center and then to  that will appear on the lower part of the screen.
- If you drag an icon that cannot be removed,  will not appear.

Preset Layouts

You can choose from 3 preset icon layouts. Only default icons will be displayed. Added icons will not appear.

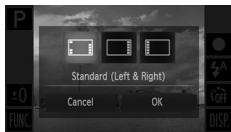

- Touch [Preset Layouts] in the layout screen in Step 1 on p. 174.
- Touch the desired icon arrangement, then touch [OK].
- If you touch [Cancel], the layout will not change, and the settings screen will reappear.



You can also display the layout screen if you touch **FUNC.**, then **MENU**, and choose [Icon Layout] from the  tab.

Changing Playback Function Settings

You can adjust the settings in the  tab by pressing the  button (p. 47).

Turning Off Active Display

You can turn off Active Display (pp. 29, 127) so that gently tapping the side of the camera or tilting the camera does not cause images to switch.

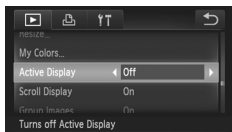

- Choose [Active Display], then touch  to choose [Off].

Choosing the Image that First Displays in Playback

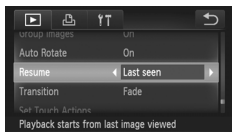



- Choose [Resume], then touch  to choose an option.

Last seen	Resumes with the image last viewed.
Last shot	Resumes with the most recently shot image.

Turning Off the Auto Rotate Function

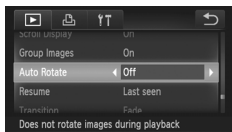
When you play back images on the camera, images shot in vertical orientation automatically rotate and display vertically. You can turn off this function.



- Select [Auto Rotate], then touch  to select [Off].



- Images cannot be rotated (p. 144) if you have set [Auto Rotate] to [Off]. Rotated images will also appear in their original orientation.
- In Smart Shuffle (p. 130), even if [Auto Rotate] is set to [Off], images taken vertically will be displayed vertically, while rotated images will appear in their rotated orientation.

11

Useful Information

This chapter introduces how to use the AC adapter kit and Eye-Fi card (both sold separately), troubleshooting tips, and contains lists of functions and items that appear on the screen.

Using Household Power

If you use AC Adapter Kit ACK-DC40 (sold separately), you can use the camera without worrying about how much charge is left in the battery.

1 Turn off the camera.

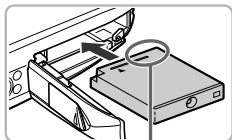

Terminal

2 Insert the coupler.

- Follow Step 2 on [p. 17](#) to open the cover, then insert the coupler as shown until it locks into place with a click.
- Follow Step 5 on [p. 18](#) to close the cover.

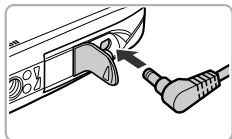

3 Plug the cord into the coupler.

- Open the cover and fully insert the plug into the coupler.

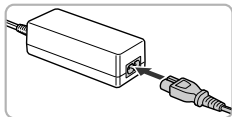

4 Connect the power cord.

- Connect the power cord to the compact power adapter, then plug the other end into a power outlet.
- Turn the camera on to use it.
- After you finish, turn off the camera and unplug the power cord from the power outlet.



Do not unplug the plug or power cord with the camera turned on. This could erase images you have taken or damage the camera.

Using an Eye-Fi Card

Before using an Eye-Fi card, be sure to check whether Eye-Fi card use is authorized in the country or territory of use (p. 17).

When you put a prepared Eye-Fi card into the camera, you can automatically transfer your images wirelessly to a computer, or upload them to a web service.

Image transfer is a function of the Eye-Fi card. For details on how to setup and use the card, and concerning problems transferring images, please refer to the Eye-Fi card user guide, or contact the manufacturer.



Please keep the following things in mind when using an Eye-Fi card.



- Even if you set [Eye-Fi trans.] to [Disable] (p. 180), the Eye-Fi card may transmit radio waves. Be sure to remove the Eye-Fi card from the camera before entering areas that prevent unauthorized transmission of radio waves, such as hospitals and airplanes.
- If you have trouble transferring images, check the card or computer settings. For details, refer to the user guide supplied with the card.
- Depending on the connection status of the wireless network, it may take time to transfer images, or image transfer may be interrupted.
- Due to its transfer function, the Eye-Fi card may become hot.
- Battery consumption will be quicker than in normal use.
- Camera operations will be slower than in normal use. This may be resolved by setting [Eye-Fi trans.] to [Disable].

If you put an Eye-Fi card into the camera, the connection status can be checked in the shooting screen (information display) and playback screen (simple information display).

(Gray)	Not connected
(Flashing white)	Connecting
(White)	Transfer standby
(Animated)	Transferring
	Interrupted
	Error retrieving Eye-Fi card info (Turn the camera off and on again. If this continues to appear, there may be a problem with the card.)

will appear on transferred images.



- The power saving function does not work while transferring images (p. 52).
- Choosing  will interrupt the Eye-Fi connection. Choosing another Shooting mode or entering Playback mode will reopen the Eye-Fi connection, but movies made with  may be transferred again.

Checking Connection Information

You can check the Eye-Fi card's access point SSID, or connection status.

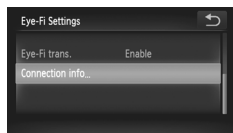

Choose [Connection info].

- Touch **FUNC.**, then **MENU** to choose the **Y↑** tab, and touch [Eye-Fi Settings].
- Touch [Connection info], then touch [Connection info] again.
- ▶ The connection info screen will appear.

Disabling Eye-Fi Transfer

You can set the card to disable Eye-Fi transfer.

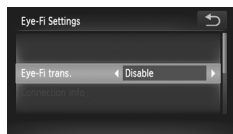

Choose [Disable] in [Eye-Fi trans.].

- Touch **FUNC.**, then **MENU** to choose the **Y↑** tab, and touch [Eye-Fi Settings].
- Choose [Eye-Fi trans.], then touch **◀▶** to choose [Disable].



What if [Eye-Fi Settings] does not appear?

[Eye-Fi Settings] will not appear when an Eye-Fi card is not inserted in the camera, and when an Eye-Fi card's write-protect tab is in the locked position. For this reason, settings cannot be changed for Eye-Fi cards equipped with a write-protect tab when the tab is in the locked position.

Troubleshooting

If you think there is a problem with the camera, first check the following. If the items below do not solve your problem, contact a Canon Customer Support Help Desk as listed on the included customer support list.

Power

You pressed the ON/OFF button, but nothing happened.

- Confirm that the battery is the correct type, and is not depleted (p. 16).
- Confirm that the battery is properly inserted (p. 18).
- Confirm that the memory card/battery cover is securely closed (p. 18).
- If the battery terminals are dirty, battery performance will decrease. Clean the terminals with a cotton swab and re-insert the battery several times.

Battery is consumed quickly.

- Battery performance decreases at low temperatures. Warm the battery, for example, by placing it in your pocket with the terminal cover on.

Lens will not retract.

- Do not open the memory card/battery cover while the power is on. After closing the memory card/battery cover, turn the power on then back off (p. 18).

TV Output

Image is distorted or not showing on TV (p. 134).

Shooting

Cannot shoot.

- When in Playback mode (p. 22), press the shutter button halfway (p. 24).

Screen does not display properly in dark places (p. 45).

Screen does not display properly while shooting.

Please note, the following will not be recorded in still images, but will be recorded in movies.

- When shooting under fluorescent or LED lighting, the screen may flicker, and a horizontal bar may appear.

A flashing appears on the screen and the shot cannot be taken even though the shutter button was pressed fully (p. 27).

appears when the shutter button is pressed halfway (p. 54).

- Set the [IS mode] to [Continuous] (p. 173).
- Set the flash to  (p. 85).
- Increase the ISO speed (p. 88).
- Attach the camera to a tripod. Additionally, you should set the [IS Mode] to [Off] when shooting with a tripod (p. 173).

Image is blurred.

- Press the shutter button halfway to focus on the subject, then press fully to shoot (p. 24).
- Shoot the subject within the focusing distance (p. 201).
- Set the [AF-assist Beam] to [On] (p. 171).
- Confirm that functions which you do not intend to use (macro, etc.) are not set.
- Shoot using the focus lock or AF lock (pp. 96, 99).

Even when you press the shutter button halfway, the AF frame does not appear, and the camera does not focus.

- If you center on the light and dark contrasting area of the subject and push the shutter button halfway, or repeatedly push the shutter button halfway, the AF frame will appear and the camera will focus.

Subject is too dark.

- Set the flash to  (p. 85).
- Correct the brightness with exposure compensation (p. 85).
- Adjust the image with i-Contrast (pp. 89, 149).
- Use spot metering or AE Lock to shoot (pp. 101, 102).

Subject is too bright (overexposed).



- Set the flash to  (p. 54).
- Correct the brightness with exposure compensation (p. 85).
- Use spot metering or AE Lock to shoot (pp. 101, 102).
- Reduce the light illuminating the subject.

Image is dark even though the flash fired (p. 27).

- Shoot within an appropriate distance for flash photography (p. 85).
- Increase the ISO speed (p. 88).

Image taken using the flash is too bright (overexposed).

- Shoot within an appropriate distance for flash photography (p. 85).
- Set the flash to  (p. 54).

White dots appear on the image when shooting with the flash.

- Light from the flash has reflected off dust particles or other objects in the air.

Image appears rough or grainy.

- Shoot with the ISO speed on a lower setting (p. 88).
- Depending on the Shooting mode, when shooting in a high ISO speed the image may appear rough or grainy (pp. 65, 66).

Eyes appear red (p. 104).

- Set the [Red-Eye Lamp] to [On] (p. 171). When shooting with the flash, the lamp (on the front of the camera) lights (p. 42), and for approximately 1 second while the camera is reducing red-eye, it is not possible to shoot. It is more effective if the subject is looking directly at the lamp. Even better results can be obtained by increasing the lighting in indoor settings or approaching closer to the subject.
- Correct images with red-eye correction (p. 150).

Recording images to the memory card takes a long time, or continuous shooting slows down.

- Perform a low-level format of the memory card in the camera (p. 165).

Cannot make settings for shooting functions or FUNC. menu.

- The items in which settings can be made differ depending on the shooting mode. Refer to “Functions Available in Each Shooting Mode” and “Shooting Menu” (pp. 192 – 197).

Shooting Movies

Correct shooting time does not display, or stops.

- Format the memory card in the camera, or use a memory card capable of recording at high speeds. Even when the shooting time does not display properly, the recorded video will be the length that it was actually shot (pp. 23, 32).

! appeared on the screen and shooting ended automatically.

The camera's internal memory was insufficient. Try one of the following:

- Perform a low-level format of the memory card in the camera (p. 165).
- Change the image quality setting (p. 116).
- Use a memory card capable of recording at high speeds (p. 116).

Subject appears distorted.

- The subject may appear distorted if it passes quickly in front of the camera while shooting.

Playback

Cannot play back images or movies.

- If the file name or folder structure is changed on a computer, you may not be able to play back images or movies. Refer to the *Software Guide* for information regarding folder structure or file names.

Playback stops, or audio cuts out.

- Use a memory card that has had a low-level format performed on it with this camera (p. 165).
- If you copy a movie to a memory card that reads slowly, playback may interrupt momentarily.
- Depending on its capabilities, when playing movies on a computer, frames may drop or the audio may cut out.

Screen

Touch operations do not work as expected.

- Since the camera uses a pressure sensitive touch panel, try touching the screen slightly harder or use the toggle attached to the strap (p. 14).
- Calibrate the touch panel (p. 170).



! appears on the upper right of the screen.

- You are touching the upper right part of the screen. Take your finger off the screen.

Computer

Cannot transfer images to a computer.

It may be possible to solve the problem when the camera is connected to a computer via cable by reducing the transfer speed.

- Turn off the camera. Keep the shutter button pressed fully and move the zoom lever toward , then press the  button. Now move the zoom lever toward . Touch [B] in the screen that appears, then touch it again.

Eye-Fi Card

Cannot transfer images (p. 179).

List of Messages That Appear on the Screen

If error messages appear on the screen, try one of the following solutions.

No memory card

- The memory card is not installed in the correct direction. Install the memory card in the correct direction (p. 18).

Memory card locked

- The SD memory card, SDHC memory card, SDXC memory card or Eye-Fi card's write protect tab is set to "LOCK". Unlock the write protect tab (p. 17).

Cannot record!

- You attempted to shoot an image without a memory card. Install the memory card in the correct direction to shoot (p. 18).

Memory card error (p. 165)

- If the same message appears even when a formatted memory card is installed in the correct direction, contact a Canon Customer Support Help Desk (p. 18).

Insufficient space on card

- There is not enough free space on the memory card to shoot (pp. 25, 31, 53, 83, 111) or edit images (pp. 145 – 150). Erase the images (pp. 30, 139) to open space for new images, or insert an empty memory card (p. 17).

Touch AF unavailable

- Touch AF cannot be used in your current Shooting mode (p. 192).
- You are touching the upper right part of the screen (p. 13). Only touch the location where you want to use Touch AF.

Touch AF canceled

- The camera could no longer recognize the subject you selected using Touch AF (p. 98).

Change the battery pack. (p. 17)**No Image.**

- There are no images recorded on the memory card that can be displayed.

Protected! (p. 137)**Unidentified Image/Incompatible JPEG/Image too large./Cannot play back AVI/RAW**

- Unsupported images, or images with corrupted data cannot be displayed.
- Images manipulated on a computer, that have had their file name changed, or have been taken with a different camera may not display.

Cannot magnify!/Cannot play back this content in Smart Shuffle/Cannot rotate/Cannot modify image/Cannot register this image!/Cannot modify/ Cannot assign to category/Unselectable image.

- Incompatible images cannot be magnified (p. 127), played back in Smart Shuffle (p. 130), tagged as favorites (p. 141), rotated (p. 144), edited (pp. 145 – 150), registered to the start-up screen (p. 166), categorized (p. 143), or added to a print list (p. 159).
- Grouped images cannot be processed (p. 80).
- Images manipulated on a computer, that have had their file name changed, or have been taken with a different camera may not be magnified, played back in Smart Shuffle, tagged as favorites, rotated, edited, registered to the start-up screen, categorized, or added to a print list.
- Movies cannot be magnified (p. 127), played back in Smart Shuffle (p. 130), edited (pp. 145 – 150), added to a print list (p. 159), or registered to the start-up screen (p. 166).

Exceeded selection limit

- You chose more than 998 images in print settings. Choose less than 998 images (p. 161).
- Print settings could not be saved correctly. Reduce the number of selected images and try again (p. 161).
- You chose 501 or more images in Protect (p. 137), Erase (p. 139), Favorites (p. 141), My Category (p. 143) or Print Settings (p. 159).

Communication error

- Images could not be transferred to the computer or printed due to the large amount of images (approx. 1000) stored on the memory card. Use a commercially available USB card reader to transfer the images. Insert the memory card into the printer's card slot to print.

Naming error!

- The folder or image could not be created because there is an image with the same file name as the folder or image that the camera is attempting to create, or the highest possible file number has already been reached. In the **↑↑** menu, change [File Numbering] to [Auto Reset] (p. 167) or format the memory card (p. 23).

Lens Error

- This error can occur if you hold the lens while it is in motion or when using it in a location with excessive dust or sand in the air.
- If this error message continues to appear, contact a Canon Customer Support Help Desk as there may be a problem with the lens.

A camera error was detected (Error number)

- If an error code appears directly after taking a picture, the shot may not have been recorded. Check the image in Playback mode.
- If this error code reappears, note the Error number (Exx) and contact a Canon Customer Support Help Desk as there may be a problem with the camera.

File Error

- Photos from other cameras or images that have been altered using computer software may not be printable.

Print error

- Check the paper size settings. If this message appears when the settings are correct, turn the printer off and back on, then make the settings again.

Ink absorber full

- Contact a Canon Customer Support Help Desk for an ink absorber replacement.

Information Displayed on the Screen

Shooting (Information Display)

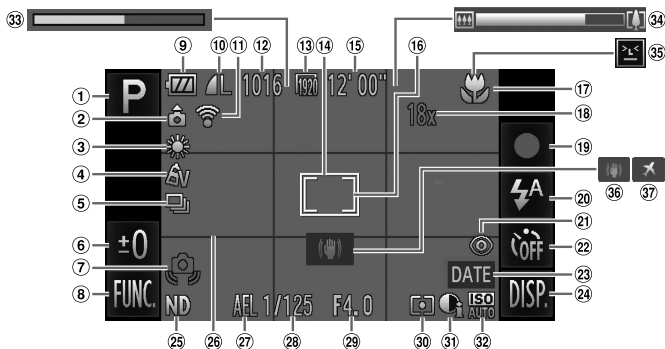

- | | | |
|--|--|--|
| ① Shooting Mode (p. 192), Scene Icon (p. 188) | ⑫ Recordable Shots (p. 61) | ⑳ DISP. (Display) (p. 44) |
| ② Camera Orientation* | ⑬ Image Quality (Movies) (p. 116) | ㉕ ND Filter (p. 27) |
| ③ White Balance (p. 86) | ⑭ AF Frame (p. 95) | ㉖ Grid Lines (p. 172) |
| ④ My Colors (p. 92) | ⑮ Remaining Time (p. 116) | ㉗ AE Lock (p. 102), FE Lock (p. 102) |
| ⑤ Drive Mode (p. 91) | ⑯ Spot AE Point Frame (p. 101) | ㉘ Shutter Speed (p. 108) |
| ⑥ Exposure Compensation Amount (p. 85) | ⑰ Focusing Range (p. 94), AF Lock (p. 99) | ㉙ Aperture Value (p. 109) |
| ⑦ Camera Shake Warning (p. 26) | ⑱ Digital Zoom Magnification (p. 55) / Digital Teleconverter (p. 56) | ㉚ Metering Method (p. 101) |
| ⑧ FUNC. (Function) (p. 46) | ㉒ Shooting Movies (p. 31) | ㉛ i-Contrast (p. 89) |
| ⑨ Battery Charge Indicator (p. 16) | ㉓ Flash Mode (pp. 54, 85) | ㉜ ISO Speed (p. 88) |
| ⑩ Compression (Image Quality) (p. 60) / Recording Pixels (pp. 60, 116) | ㉔ Red-Eye Correction (p. 150) | ㉝ Super Slow Motion Movie Shooting Time (p. 114) |
| ⑪ Eye-Fi Connection Status (p. 179) | ㉖ Self-Timer (pp. 58, 59) | ㉞ Zoom Bar (p. 26) |
| | ㉗ Date Stamp (p. 57) | ㉟ Blink Detection (p. 105) |
| | | ㊱ Image Stabilizer (p. 173) |
| | | ㊲ Time Zone (p. 169) |

* : Standard, : Held vertically

When shooting, the camera detects if it is held vertically or horizontally, and adjusts settings accordingly for the best shot. It also detects orientation during playback, so you can hold the camera in either orientation and it will automatically rotate images for correct viewing.

This function may not operate correctly when the camera is pointed straight up or down.

Scene Icons

In **AUTO** mode, the camera displays an icon for the scene it has determined and then automatically focuses and selects the optimum settings for subject brightness and color.

Subject Background	People			Non-Human Subjects			Icon Background Color
	When Moving	With Strong Facial Shadows		When Moving	When Close		
Bright				AUTO			Gray
Backlit			—				
Including Blue Skies				AUTO			Light Blue
Backlit			—				
Sunsets	—				—		Orange
Spotlights							
Dark				AUTO			Dark Blue
When Using Tripod		—			—		





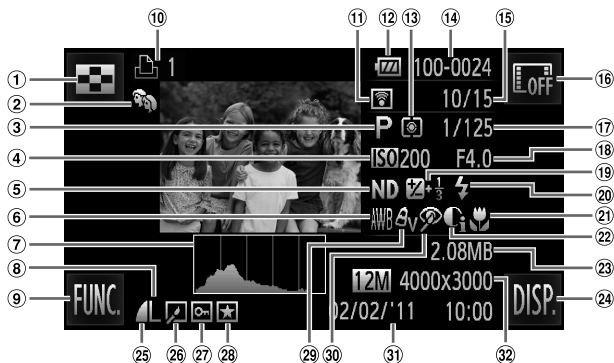



* Appears when the scene is dark and the camera is attached to a tripod.

Playback (Detailed Information Display)



- | | | |
|--|---|--|
| ① Index Display (p. 120) | ⑬ Metering Mode (p. 101) | ⑳ File Size (pp. 61, 116) |
| ② My Category (p. 143) | ⑭ Folder Number – File Number (p. 167) | ㉑ DISP. (Display) (p. 44) |
| ③ Movies (p. 33), High-speed Burst (p. 80), Shooting Mode (p. 192) | ⑮ Displayed image number / Total number of images | ㉒ Compression (Image Quality) (p. 60) |
| ④ ISO Speed (p. 88), Playback Speed (Movies) (p. 114) | ⑯ No Information Display (p. 44) | ㉓ Group Playback (p. 128), Image Editing (pp. 145 – 150) |
| ⑤ ND Filter (p. 27) | ⑰ Shutter Speed (Still Images) (p. 108), Image Quality / Frame Rate (Movies) (p. 116) | ㉔ Protect (p. 137) |
| ⑥ White Balance (p. 86) | ⑱ Aperture Value (p. 109) | ㉕ Favorites (p. 141) |
| ⑦ Histogram (p. 45) | ⑲ Exposure Compensation Amount (p. 85) | ㉖ My Colors (pp. 92, 148) |
| ⑧ Recording Pixels (pp. 60, 116), MOV (Movies) | ⑳ Flash (p. 85) | ㉗ Red-Eye Correction (p. 150) |
| ⑨ FUNC. (Function) (p. 46) | ㉑ Focusing Range (p. 94) | ㉘ Shooting Date and Time (p. 20) |
| ⑩ Print List (p. 159) | ㉒ i-Contrast (pp. 89, 149) | ㉙ Still Images: Recording Pixels (p. 60) |
| ⑪ Eye-Fi Transfer Complete (p. 179) | | ㉚ Movies: Movie Length (p. 116) |
| ⑫ Battery Charge Indicator (p. 16) | | |

Summary of Movie Control Panel in “Viewing Movies” (p. 33)

	Exit
	Touch to display the volume panel, then touch ▲▼ to adjust the volume. When the volume is set to 0, 🔊 will appear.
	Playback
	Skip backward* (Continues to skip backward if you keep touching the screen.)
	Previous frame (Slow rewind if you touch and hold the icon.)
	Next frame (Slow advance if you touch and hold the icon.)
	Skip forward* (Continues to skip forward if you keep touching the screen.)
	Edit (p. 117)

* Displays the frame approx. 4 sec. before or after the current frame.

















- You can skip forward or backward if you lightly tap the camera (p. 29) while viewing a movie (Active Display).
- Touch the scroll bar, or drag it left or right to change the displayed frame.

Handling Precautions

- This camera is a high-precision electronic device. Do not drop it or subject it to strong impacts.
- Never place the camera close to magnets, motors or other devices that generate strong electromagnetic fields. Exposure to strong magnetic fields may cause malfunctions or corrupt image data.
- If water droplets or dirt become stuck on the camera or screen, wipe with a dry soft cloth or eyeglass wiper. Do not rub or apply force.
- Never use cleaners containing organic solvents to wipe the camera or screen.
- Use a commercially available blower brush to remove dust from the lens. For stubborn dirt contact a Canon Customer Support Help Desk as listed in your Warranty System Booklet.
- When you move the camera rapidly from cold to hot temperatures, condensation may form on the internal or external surfaces of the camera. To avoid condensation, put the camera in an airtight, resealable plastic bag and let it adjust to temperature changes slowly before removing it from the bag.
- If condensation has formed on the camera, stop using it immediately, as continued use may damage the camera. Remove the battery and memory card, and wait until the moisture has completely evaporated before resuming use.

Functions Available in Each Shooting

Shooting Modes		AUTO										
			P	Av	Tv							
Function												
Exposure Compensation (p. 85)		—	○	○	○	○	○	○	○	○	○	○
Flash (pp. 54, 85)		○	○	—	—	○	○	○	○	○	○	○
		—	○	○	○	○	○	○	○	○	○	○
		*1	○	○	—	○	—	—	—	—	—	—
		○	○	○	○	○	○	○	○	○	○	○
Self-Timer (pp. 58, 59)		○	○	○	○	○	○	○	○	○	○	○
	  	○	○	○	○	○	○	○	—	—	—	—
Self-Timer Settings (p. 59)	Delay*3	○	○	○	○	○	○	○	—	—	—	—
	Shots*4	○	○	○	○	—	○	○	—	—	—	—
AE Lock/FE Lock*5 (p. 102)		—	○	○	○	○	—	—	—	—	—	—
AF Lock (p. 99)		—	○	○	○	○	—	—	—	—	—	—
Touch AF (p. 98)		○	○	○	○	—	○	○	*6	*6	*6	—
Screen Display (p. 44)	Information/ No Information	○	○	○	○	○	○	○	○	○	○	○

*1 Not selectable but switches to  depending on the circumstances.

*2 Not selectable but switches to  when the flash fires.



















*3 Cannot be set to 0 seconds when in modes where the number of shots cannot be set.

*4 Fixed to 1 shot when in modes where the number of shots cannot be set.

*5 FE Lock not available when set to .

*6 Only available when a face is detected.

Functions Available in Each Shooting Mode

																		
																		
○	—	○	○	○	○	○	—	○	○	—	—	○	○	○	○	—	—	
—	—	—	○	○	○	○	—	○	○	○	○	○	○	○	—	—	—	
—	—	—	—	○	○	○	○	○	○	○	○	○	○	○	—	—	—	
—	—	—	—	—	—	—	*2	—	—	—	—	—	—	—	—	—	—	
○	○	○	○	○	○	○	○	○	○	○	○	○	○	○	○	—	—	
○	○	○	○	○	○	○	○	○	○	○	○	○	○	○	○	○	○	
—	—	○	○	○	○	○	○	○	○	○	○	○	○	○	○	○	○	
—	—	○	○	○	○	○	○	○	○	○	○	○	○	○	○	○	○	
—	—	○	○	○	○	○	○	○	○	○	○	○	○	○	○	—	—	
—	—	—	—	—	—	—	—	—	—	—	—	—	—	—	—	—	—	
—	—	—	—	—	—	—	—	—	—	—	—	—	—	—	—	—	—	
○	—	—	○	—	—	—	○	○	○	○	○	○	○	○	—	—	—	
○	○	○	○	○	○	○	○	○	○	○	○	○	○	○	○	○	○	

○ Selectable, or set automatically. — Not selectable.

Functions Available in Each Shooting Mode



















Function	Shooting Modes										
	AUTO	P	Av	Tv	M	B	S	SR	SR	SR	
FUNC. Menu											
Metering Method (p. 101)		○	○	○	○	○	○	○	○	○	○
		—	○	○	○	○	—	—	—	—	—
My Colors (p. 92)	OFF	○	○	○	○	○	○	○	○	○	○
	Av AN Ae ^{*1}	—	○	○	○	○	—	—	○	○	○
	BW ^{*1} Ap AL AD AB AG AR AC ^{*2}	—	○	○	○	○	—	—	○	○	○
White Balance (p. 86)	AWB	○	○	○	○	○	○	○	○	○	○
		—	○	○	○	○	—	—	○	○	○
ISO Speed (p. 88)	ISO AUTO	○	○	○	○	○	○	○	○	○	○
	ISO 100 200 400 800 ISO 1600 ISO 3200	—	○	○	○	○	—	—	—	—	—
Focusing Range (p. 94)		○	○	○	○	○	○	○	○	○	○
		—	○	○	○	○	○	—	—	—	—
Drive Mode (p. 91)		○	○	○	○	○	○	○	○	○	○
		—	○	○	○	—	○	○	—	—	—
Aspect Ratio (Still Images) (p. 90)	16:9 3:2 4:3 1:1	○	○	○	○	—	○	○	○	○	○
	L	○	○	○	○	○	○	○	○	○	○
Recording Pixels (p. 60)	M1 M2	○	○	○	○	○	○	○	○	○	○
	M	—	—	—	—	—	—	—	—	—	—
	S	○	○	○	○	○	○	○	○	○	○
Compression Ratio (p. 60)		○	○	○	○	○	○	○	○	○	○
		○	○	○	○	○	○	○	○	○	○
Image Quality (Movies) (pp. 114, 116)	1920	○	○	○	○	○	○	○	○	○	○
	1280	○	○	○	○	○	○	○	○	○	○
	640	○	○	○	○	○	○	○	○	○	○
	320	○	○	○	○	○	○	○	○	○	○
	1920 1280	—	—	—	—	—	—	—	—	—	—

*1 White balance is not selectable.

*2 Contrast, sharpness, color saturation, red, green, blue, and skin tone can be set in 5 levels.

*3 Only 4:3 and 16:9 are available.





Functions Available in Each Shooting Mode

																	
																	
FUNC. Menu																	
○	○	○	○	○	○	○	○	○	○	○	○	○	○	○	○	○	○
—	—	—	—	—	—	—	—	—	—	—	—	—	—	—	—	—	—
○	○	○	○	○	○	○	○	○	○	○	○	○	○	○	○	○	○
—	—	—	—	—	—	—	—	—	—	—	—	—	—	—	○	—	—
○	○	○	○	○	○	○	○	○	○	○	○	○	○	○	○	○	○
○	○	—	○	—	—	—	—	—	—	—	—	—	—	—	○	—	—
○	○	○	○	○	○	○	○	○	○	○	○	○	○	○	○	○	○
—	—	—	—	—	—	—	—	—	—	—	—	—	—	—	—	—	—
○	○	○	○	○	○	○	○	○	○	○	○	○	○	○	○	○	○
○	○	○	○	○	○	○	○	○	○	○	○	○	○	○	○	—	○
—	—	○	○	○	○	○	○	○	○	○	○	○	○	○	○	○	○
○	○	—	○	○	○	○	○	○	○	○	○	○	○	○	○	—	—
—	—	—	—	—	*3	—	○	○	○	○	○	○	○	○	○	—	—
—	—	○	—	○	○	○	○	○	○	○	○	○	○	○	○	○	○
—	—	—	—	—	—	—	○	○	○	○	○	○	○	○	○	○	○
○	○	—	○	—	—	—	—	—	—	—	—	—	—	—	—	—	—
—	—	—	—	—	—	—	○	○	○	○	○	○	○	○	○	○	○
○	○	○	○	○	○	○	○	○	○	○	○	○	○	○	○	○	○
○	○	○	○	○	—	○	○	○	○	○	○	○	○	○	○	○	—
○	○	○	○	○	○	○	○	○	○	○	○	○	○	○	○	○	—
○	○	○	○	○	—	○	○	○	○	○	○	○	○	○	○	—	—
—	—	—	—	—	—	—	—	—	—	—	—	—	—	—	—	—	○

○ Selectable, or set automatically. — Not selectable.

Menus

Shooting Menu

Function		Shooting Modes										
		AUTO	P	Av	Tv	M	B	A				
AF Frame (p. 95)	Face AiAF*1	○	○	○	○	○	○	○	○	○	○	○
	Fixed frame	—	○	○	○	○	○	○	○	—	—	—
AF Frame Size*2 (p. 96)	Normal	—	○	○	○	○	○	○	○	—	—	—
	Small	—	○	○	○	○	○	○	○	—	—	—
Digital Zoom (p. 55)	Standard	○	○	○	○	○	○	○	○	○	○	○
	Off	○	○	○	○	○	○	○	○	○	○	○
	Digital Tele-converter (1.5x/2.0x)	○	○	○	○	○	○	○	○	○	○	○
AF-Point Zoom (p. 97)	On	○	○	○	○	—	○	—	○	○	○	○
	Off	○	○	○	○	○	○	○	○	○	○	○
Servo AF (p. 100)	On	—	○	○	○	—	○	○	—	—	—	—
	Off*3	○	○	○	○	○	○	—	○	○	○	○
AF-assist Beam (p. 171)	On	○	○	○	○	○	○	○	○	○	○	○
	Off	○	○	○	○	○	○	○	○	—	○	○
Flash Settings (pp. 104, 171)	Red-Eye Corr.	On	○	○	○	○	○	○	○	○	○	○
		Off	○	○	○	○	○	○	○	○	○	○
	Red-Eye Lamp	On/Off	○	○	○	○	○	○	○	○	○	○
i-Contrast (p. 89)	Auto	○	○	○	○	○	—	—	—	—	—	—
	Off	—	○	○	○	○	○	○	○	○	○	○
Safety Shift (p. 110)	On	—	—	○	○	—	—	—	—	—	—	—
	Off	○	○	○	○	○	○	○	○	○	○	○
Review (p. 172)	Off/2 – 10 sec./Hold	○	○	○	○	○	○	○	○	○	○	○
Review Info (p. 172)	Off/Detailed/Focus Check	○	○	○	○	○	○	○	○	○	○	○
Blink Detection (p. 105)	On	○	○	○	○	○	○	○	○	○	○	○
	Off	○	○	○	○	○	○	○	○	○	○	○
Grid Lines (p. 172)	On/Off	○	○	○	○	○	○	○	○	○	○	○
Icon Layout (p. 174)		○	○	○	○	○	○	○	○	○	○	○
IS Mode (p. 173)	Off	—	○	○	○	○	○	○	○	○	○	○
	Continuous	○	○	○	○	○	○	○	○	○	○	○
	Shoot Only	—	○	○	○	○	○	○	○	○	○	○
	Panning	—	○	○	○	○	○	○	○	○	○	○
Date Stamp (p. 57)	Off	○	○	○	○	○	○	○	○	○	○	○
	Date/Date & Time	○	○	○	○	○	○	○	○	○	○	○

*1 Operation differs depending on the shooting mode when faces are not detected.

*2 Available when the AF frame is set to [Fixed frame]. *3 [On] when moving people are detected in **AUTO**.

†† Set up Menu

Item	Content	Ref. Page
Mute	On/Off*	p. 49
Volume	Set all operation sounds (5 levels).	p. 49
Sound Options	Set the sounds for each camera operation.	p. 164
Hints & Tips	On*/Off	p. 164
LCD Brightness	Sets screen brightness (5 levels).	p. 50
Start-up Image	Add an image as a start-up image.	p. 166
Color Option	Orange*/Blue Gray/Khaki/Pink	p. 167
Format	Formats memory card, erasing all data	pp. 23, 165
File Numbering	Continuous*/Auto Reset	p. 167
Create Folder	Monthly*/Daily	p. 168
Lens Retract	1 min.*/0 sec.	p. 168
Power Saving	Auto Power Down: On*/Off Display Off: 10, 20 or 30 sec./1*, 2 or 3 min.	pp. 52, 168, 169
Time Zone	Home*/World	p. 169
Date/Time	Date and time settings	p. 21
Video System	NTSC/PAL	p. 134
Ctrl via HDMI	Enable/Disable*	p. 135
Calibration	Calibrates the touch panel.	p. 170
Eye-Fi Settings	Eye-Fi connection settings (only appears when Eye-Fi card is inserted)	p. 179
Language	Choose display language.	p. 22
Reset All	Returns camera to default settings.	p. 51

* Default setting

Playback Menu

Item	Content	Ref. Page
Slideshow	Plays back images automatically.	p. 124
Erase	Erases images (Select, All Images).	p. 139
Protect	Protects images (Select, All Images).	p. 137
Rotate	Rotates images.	p. 144
Favorites	Tags or untags images as favorites.	p. 141
My Category	Categorizes images.	p. 143
i-Contrast	Corrects dark portions and contrast in still images.	p. 149
Red-Eye Correction	Corrects red eyes in still images.	p. 150
Trimming	Trims portions of still images.	p. 146
Resize	Resizes and saves still images.	p. 145
My Colors	Adjusts colors in still images.	p. 148
Active Display	On*/Off	p. 176
Scroll Display	On*/Off	p. 121
Group Images	On*/Off	p. 129
Auto Rotate	On*/Off	p. 176
Resume	Last seen*/Last shot	p. 176
Transition	Fade*/Scroll/Slide/Off	p. 131
Set Touch Actions	Register a playback function to a drag pattern.	p. 132

* Default setting

Print Menu

Item	Content	Ref. Page
Print	Displays printing screen (When connected to a printer).	—
Select Images & Qty.	Chooses individual images for printing.	p. 161
Select All Images	Chooses all images for printing.	p. 162
Clear All Selections	Cancel all settings for printing.	p. 162
Print Settings	Sets the printing style.	p. 160

Playback Mode FUNC. Menu

Item	Content	Ref. Page
Rotate	Rotates displayed image.	p. 144
Print List	Selects or clears settings for printing displayed image ([Print] appears when the camera is connected to the printer).	p. 159
Protect	Protects/unlocks displayed image.	p. 137
Favorites	Tags/untags displayed image as favorites.	p. 141
Erase	Erases displayed image.	p. 139
Movie Digest Playback	Plays back movies made in the Movie Digest mode.	p. 122
Smart Shuffle	Starts Smart Shuffle.	p. 130
Filtered Playback	Filters/cancels filter for displayed image.	p. 123
Slideshow	Plays back images automatically.	p. 124
My Category	Categorizes images.	p. 143

Specifications

Image Sensor

Camera Effective Pixels Approx. 12.1 million pixels

Lens

Focal Length 4.4x zoom: 4.3 (W) – 18.8 (T) mm
(35mm film equivalent: 24 (W) – 105 (T) mm)

Focusing Range 3 cm (1.2 in.) – infinity (W), 40 cm (1.3 ft.) – infinity (T)
• Macro 3 – 50 cm (W) (1.2 in. – 1.6 ft. (W))

Image Stabilizer System Lens-shift type

Imaging Processor DIGIC 4

LCD Monitor

Type TFT color (wide viewing angle type)

Size 8.0 cm (3.2 in.)

Effective Pixels Approx. 461,000 dots

Aspect Ratio 16:9

Features Touch panel
Brightness adjustment (5 levels)

Focus

Control System Autofocus: Single (Continuous in Auto mode), Servo AF/
Servo AE, Touch AF

AF Frame Face AiAF, Fixed frame

Metering System Evaluative, Center-weighted average, Spot

Exposure Compensation

(Still Images) /

Exposure Shift (Movies) ±2 stops in 1/3-stop increments

ISO Speed

(Standard Output Sensitivity,

Recommended Exposure Index) Auto, ISO 100/200/400/800/1600/3200

White Balance Auto, Day Light, Cloudy, Tungsten, Fluorescent,
Fluorescent H, Custom

Shutter Speed 1 – 1/1600 sec.
15 – 1/1600 sec. (Total shutter speed range)

Aperture

Type Iris (Used together with ND filter)

f/number f/2.0 – f/8.0 (W), f/5.8 – f/8.0 (T)

Flash

Modes Auto, on, Slow Synchro, off

Range 50 cm – 5.0 m (W), 50 cm – 2.0 m (T)
(1.6 – 16 ft. (W), 1.6 – 6.6 ft. (T))

Specifications

Shooting Modes	Auto* ¹ , P, Av, Tv, Movie Digest, Portrait, Kids&Pets, Smart Shutter* ² , High-speed Burst, Best Image Selection, Handheld Night Scene, Low Light, Fish-eye Effect, Miniature Effect, Toy Camera Effect, Creative Light Effect, Monochrome, Super Vivid, Poster Effect, Color Accent, Color Swap, Beach, Foliage, Snow, Fireworks, iFrame Movie, Super Slow Motion Movie
	• Movies are recorded by pressing the movie button.
	*1 Smart Auto also available for movies
	*2 Smile, Wink Self-timer, Face Self-timer
Digital Zoom	Still images/Movies: Approx. 4.0x (up to approx. 18x in combination with the optical zoom) Safety Zoom, Digital tele-converter
Continuous Shooting	
Mode	Normal
Speed (Normal).....	Approx. 3.4 shots/sec. (In P mode)
	Approx. 8.2 shots/sec. (In High-speed Burst mode)
Number of Shots (Approximate) (CIPA compliant)	Approx. 180
Recording Media	SD memory card, SDHC memory card, SDXC memory card, MultiMediaCard, MMC <i>plus</i> card, HC MMC <i>plus</i> card
File Format	Design rule for Camera File system, DPOF (Version 1.1) compliant
Data Type	
Still Images	Exif 2.3 (JPEG)
Movies.....	Movies: MOV (Image data: H.264; Audio data: Linear PCM (stereo))
Number of Recording Pixels	
Still Images	16:9
	Large: 4000 x 2248, Medium 1: 2816 x 1584, Medium 2: 1920 x 1080, Small: 640 x 360
	3:2
	Large: 4000 x 2664, Medium 1: 2816 x 1880, Medium 2: 1600 x 1064, Small: 640 x 424
	4:3
	Large: 4000 x 3000, Medium 1: 2816 x 2112, Medium 2: 1600 x 1200, Small: 640 x 480
	1:1
	Large: 2992 x 2992, Medium 1: 2112 x 2112, Medium 2: 1200 x 1200, Small: 480 x 480

Movies.....	<p>Super Slow Motion Movie: 640 x 480 (120 fps^{*1} when shooting, 30 fps^{*2} during playback), 320 x 240 (240 fps^{*3} when shooting, 30 fps^{*2} during playback) Miniature Effect: 1280 x 720^{*4}, 640 x 480^{*4} iFrame Movie: 1280 x 720 (30 fps^{*2}) Movies other than the above: 1920 x 1080 pixels (24 fps^{*5}), 1280 x 720 (30 fps^{*2}), 640 x 480 (30 fps^{*2}), 320 x 240 (30 fps^{*2}) ^{*1} Actual frame rate is 119.88 fps. ^{*2} Actual frame rate is 29.97 fps. ^{*3} Actual frame rate is 239.76 fps. ^{*4} Shooting: 6 fps/3 fps/1.5 fps, Playback: 30 fps^{*2} ^{*5} Actual frame rate is 23.976 fps.</p>
Interface.....	<p>Hi-Speed USB HDMI output Analog audio output (stereo) Analog video output (NTSC/PAL)</p>
Direct Print Standard	PictBridge
Power Source	<p>Battery Pack NB-6L Compact Power Adapter CA-DC10 (when used with DC Coupler DR-40)</p>
Dimensions (CIPA compliant).....	100.6 x 55.4 x 25.0 mm (3.96 x 2.18 x 0.98 in.)
Weight (CIPA compliant)	<p>Approx. 185 g (6.53 oz.) (Including the battery and memory card) Approx. 165 g (5.82 oz.) (camera body only)</p>

Battery Pack NB-6L

Format	Rechargeable Lithium-ion Battery Pack
Nominal Voltage	3.7 V DC
Nominal Capacity	1000 mAh
Charging Cycles	Approx. 300 times
Operating Temperatures	0 – 40 °C (32 – 104 °F)
Dimensions	34.4 x 41.8 x 6.9 mm (1.35 x 1.65 x 0.27 in.)
Weight	Approx. 21 g (Approx. 0.74 oz.)

Battery Charger CB-2LY/CB-2LYE

Rated Input	100 V – 240 V AC (50/60 Hz), 0.085 A (100 V) – 0.05 A (240 V)
Rated Output	4.2 V DC, 0.7 A
Charge Time	Approx. 1 hour 55 min. (when using NB-6L)
Operating Temperatures	0 – 40 °C (32 – 104 °F)
Dimensions	58.6 x 86.4 x 24.1 mm (2.31 x 3.40 x 0.95 in.)
Weight	Approx. 70 g (Approx. 2.47 oz.) (CB-2LY) Approx. 61 g (Approx. 2.15 oz.) (CB-2LYE) (excluding power cord)

- All data is based on tests by Canon.
- Camera specifications or appearance are subject to change without notice.

Index

A

AC Adapter Kit.....	39, 178
Accessories.....	39
Active Display.....	29, 176
AE Lock.....	102
AF Frames.....	26, 95
AF → Focus	
AF Lock.....	99, 187
AF-Point Zoom.....	97
Aspect Ratio.....	90
AUTO Mode (Shooting Mode).....	25
Av (Shooting Mode).....	109

B

Battery	
Charge Indicator.....	16
Power Saving.....	52, 168, 169
Recharge.....	15
Battery Charger.....	2, 39
Beach (Shooting Mode).....	65
Best Image Selection (Shooting Mode)...	81
Black and White Images.....	92
Blink Detection.....	105

C

Calibration.....	170
Camera	
Default Settings.....	51
Holding the Camera.....	13
Camera Shake.....	27, 54, 173
Color Accent (Shooting Mode).....	72
Color Swap (Shooting Mode).....	73
Components Guide.....	42
Compression (Image Quality).....	60
Continuous Shooting.....	91
Best Image Selection.....	81
High-speed Burst.....	80
Creative Light Effect (Shooting Mode).....	71
Custom White Balance.....	87

D

Date and Time → Date/Time	
Date/Time	
Adding to Image.....	57

Changing.....	21
Setting.....	20
World Clock.....	169
Default Settings.....	51
DIGITAL CAMERA Solution Disk.....	2
Digital Tele-Converter.....	56
Digital Zoom.....	55
Display Language.....	22
DPOF.....	159
Drag.....	14
Drive Mode.....	91
Dynamic Mode.....	173

E

Editing	
i-Contrast.....	149
My Colors.....	148
Red-Eye Correction.....	150
Resizing (Making Images Smaller).....	145
Trimming.....	146
Erasing All Images.....	140
Erasing Images.....	30, 139
Error Messages.....	184
Exposure	
AE Lock.....	102
Correction.....	85
FE Lock.....	102
Eye-Fi Card.....	17, 179

F

Face AiAF (AF Frame Mode).....	95
Face Self-Timer (Shooting Mode).....	78
Factory Settings → Default Settings	
FE Lock.....	102, 187
File Numbering.....	167
Fireworks (Shooting Mode).....	66
Fish-eye Effect (Shooting Mode).....	69
Fixed Frame (AF Frame Mode).....	96
Flash	
Off.....	54
On.....	85
Slow Synchro.....	103
Focus	
AF Frames.....	26, 95

- AF Lock 99
 AF-Point Zoom 97
 Servo AF..... 100
 Touch AF 98
 Focus Check 126
 Focus Lock..... 96
 Focusing Range
 Infinity 94
 Macro..... 94
 Foliage (Shooting Mode)..... 65
 Format → Memory Cards, Formatting
 Formatting (Memory Card)..... 23, 165
 FUNC. Menu
 Basic Operations 46
 List..... 192, 200
- G**
- Grid Lines 172, 187
- H**
- Handheld NightScene
 (Shooting Mode)..... 65
 High-speed Burst (Shooting Mode)..... 80
 Household Power..... 178
- I**
- Icon Layout..... 174
 i-Contrast..... 89, 149
 iFrame Movie (Shooting Mode)..... 112
 Image Quality → Compression Ratio
 Images
 Display Time..... 172
 Editing → Editing
 Erasing Images..... 30, 139
 Playback → Viewing
 Protect 137
 Included Items → Accessories
 Indicator..... 43, 45
 Infinity (Focus Mode)..... 94
 Interface Cable..... 2, 36, 152
 ISO Speed..... 88, 187
- K**
- Kids&Pets (Shooting Mode)..... 65
- L**
- Lamp 42, 171
 LCD Monitor → Screen
 Low Light (Shooting Mode) 65
- M**
- Macro (Focus Mode) 94
 Magnified Display 127
 Memory Cards..... 17
 Available Shots..... 19, 61
 Formatting 23, 165
 Shooting Time 32
 Menu
 Basic Operations 47
 List..... 196
 Metering Method 101
 Miniature Effect (Shooting Mode).... 70, 113
 Monochrome (Shooting Mode)..... 74
 Movie Digest (Shooting Mode)..... 67
 Movies
 Editing..... 117
 Image Quality (Recording Pixels/
 Frame Rate) 116
 Shooting Time 32, 116
 Viewing (Playback) 33
 MultiMediaCard/MMC*plus*/HC MMC*plus* →
 Memory Cards
 My Category 143
 My Colors (Playback) 148
 My Colors (Shooting)..... 92
- P**
- P (Shooting Mode) 84
 PictBridge 40, 152
 Playback → Viewing
 Playback With Transition Effects..... 131
 Portrait (Shooting Mode) 64
 Poster Effect (Shooting Mode) 68
 Power → Battery, AC Adapter Kit
 Power Saving 52, 168, 169
 Printing 152
 Program AE..... 84
 Protect..... 137

R

Recording Pixels (Image Size)	60
Red-Eye Correction	104, 150
Resizing (Making Images Smaller)	145
Rotate	144

S

Safety Shift	110
Screen	
Display Language	22
Information Display	187, 189
Menu → FUNC. Menu, Menu	
Switching the Display	44
Scroll Display	121
SD/SDHC/SDXC Memory Card → Memory Cards	
Self-Timer	
10 Second Self-Timer	58
Changing Delay and Number of Shots	59
Face Self-Timer (Shooting Mode)	78
Two Second Self-Timer	59
Wink Self-Timer (Shooting Mode)	77
Sepia Tones	92
Servo AF	100
Shooting	
Number of Shots	16, 19, 61
Shooting Date and Time → Date/Time	
Shooting Info	187
Shooting Time	32
Slideshow	124
Smart Shuffle	130
Smile (Shooting Mode)	76
Snow (Shooting Mode)	66
Software	
DIGITAL CAMERA Solution Disk	2
Installation	35
Software Guide	2
Transferring Images to a Computer for Viewing	34
Sound Settings	49
Stereo AV Cable	2, 133
Strap	2, 13, 14
Super Slow Motion (Shooting Mode)	114
Super Vivid (Shooting Mode)	68

T

Tag Images as Favorites	141
Terminal	36, 133, 134, 152, 178
Toggle	14
Touch	14
Touch Actions	131, 132
Touch AF	28, 98
Touch Panel	14
Toy Camera Effect (Shooting Mode)	75
Travel Abroad	16, 39, 169
Trimming	146
Troubleshooting	181
Tv (Shooting Mode)	108

V

Video → Movies	
Viewing	
Filtered Playback	123
Images on a TV	133
Index Display	120
Magnified Display	127
Scroll Display	121
Single Image Playback	28
Slideshow	124
Smart Shuffle	130
Viewing Images on a TV	133

W

White Balance	86
Wink Self-Timer (Shooting Mode)	77
World Clock	169
Wrist Strap → Strap	

Z

Zoom	26, 31, 55
------------	------------

Disclaimer

- Reprinting, transmitting, or storing in a retrieval system any part of this guide without the permission of Canon is prohibited.
- Canon reserves the right to change the contents of this guide at any time without prior notice.
- Illustrations and screenshots in this guide may differ slightly from the actual equipment.
- The above items notwithstanding, Canon accepts no liability for damages due to mistaken operation of the products.
- The iFrame logo and the iFrame symbol are trademarks of Apple Inc.