

ASSEMBLY AND INSTALLATION INSTRUCTIONS

T0290

WARNING: TO AVOID RISK OF ELECTRICAL SHOCK, BE SURE TO SHUT OFF POWER WHILE INSTALLING OR SERVICING THIS FIXTURE.

NOTE: 1. Before installing, consult local electrical codes for wiring and grounding requirements.
2. READ AND SAVE THESE INSTRUCTIONS.

Hardware Package (included):

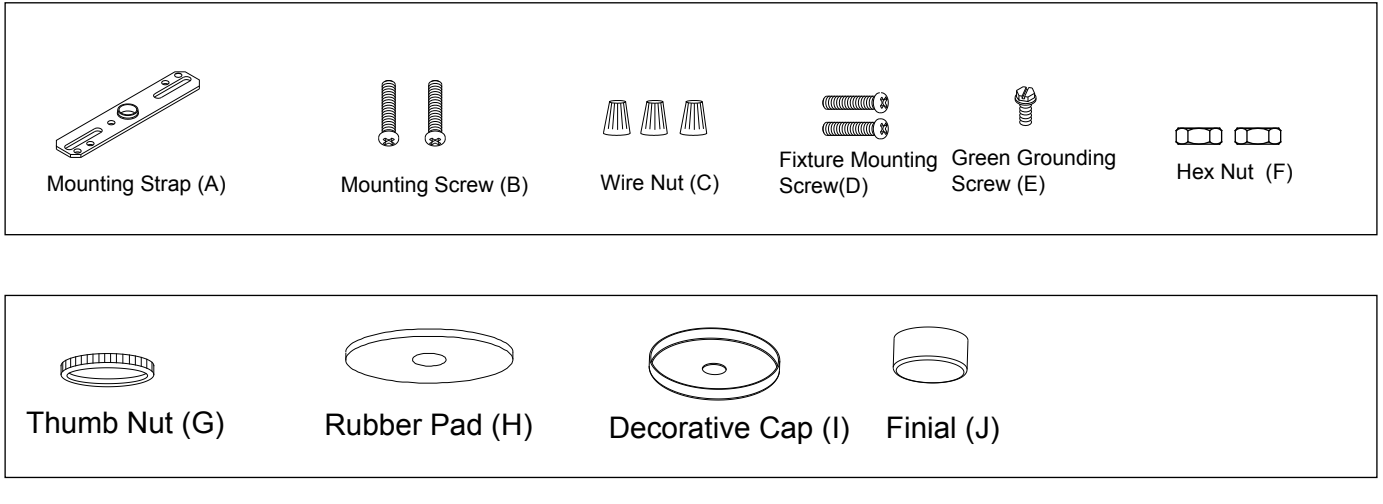

Installation Steps

Turn off the power at fuse or circuit box.

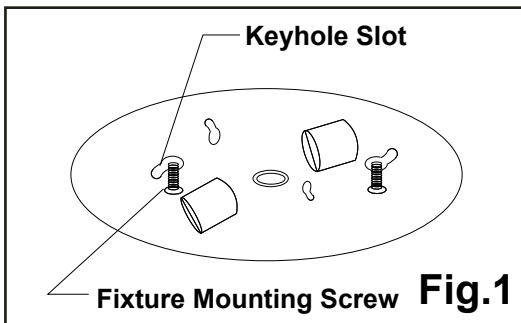

1. Attach two fixture mounting screws to the mounting strap, and then secure it with two lock nuts. Adjust the length of the fixture mounting screws if necessary.
2. Attach the mounting strap to the outlet box using two mounting screws.

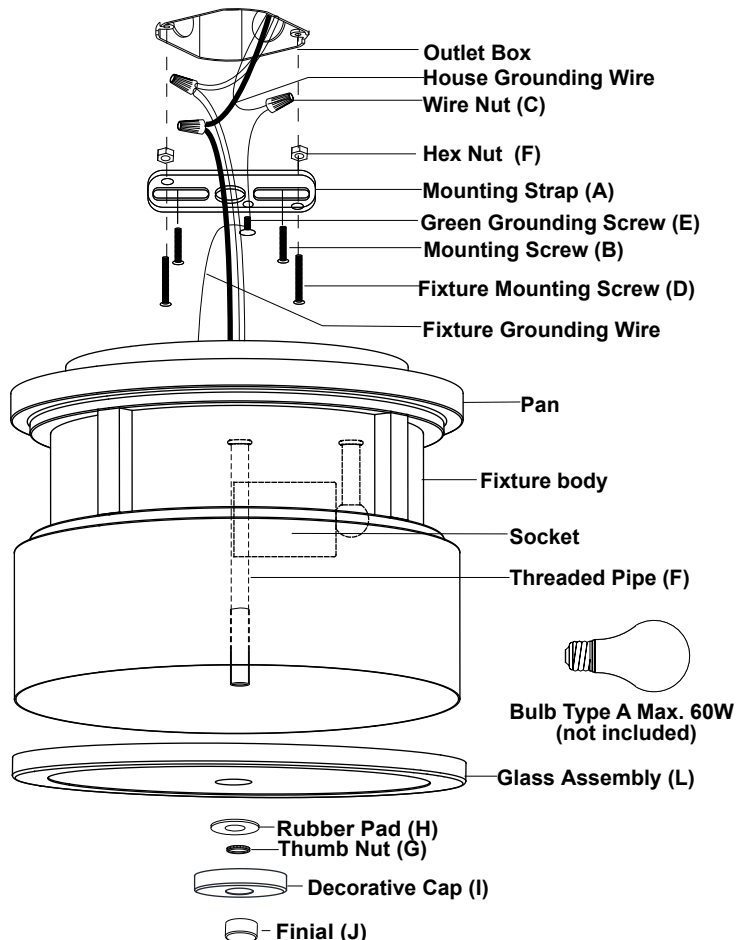

 **VAXCEL**







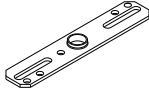

161006

3. Pull out the outlet wires and the house grounding wire from the outlet box. Make wire connections using the wire nuts:
 - The black (hot) wire from the fixture to the black (hot) wire from the power source.
 - The white (neutral) wire from the fixture to the white (neutral) wire from the power source.
 - Attach the fixture grounding wire to the mounting strap with the green grounding screw. Then connect it to the house grounding wire with the wire nut.
 Carefully put the wires back into the outlet box.
4. Attach the pan to the mounting strap by inserting two fixture mounting screw heads into the key holes, and rotate the pan until it locks in place. Then secure the screws tightly. (See Fig.1)
5. Install bulbs (not included). See relamping label at socket area or packaging for maximum allowed wattage.
6. Slip the glass assembly up through threaded pipe and secure it with a rubber pad and thumb nut. Slide the decorative cap up to glass assembly, and secure it with the finial.

Turn off the power at fuse or circuit box.

The following parts are available for re-order if damaged or missing.

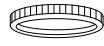
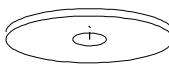
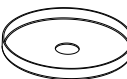
Spare Parts List:

					 Mounting Hardware 5606MM(1 SET)
Mounting Strap (A)	Mounting Screw (B)	Wire Nut (C)	Fixture Mounting Screw (D)	Green Grounding Screw (E)	
				 Hardware Package 5607MM(1 SET)	
Thumb Nut (F)	Rubber Pad (G)	Decorative Cap (H)	Finial (I)		

