

MODEL/S
GGFLW6002B
GGFLW6002W
GGFLW8002W
GGFLW9002B

V2.0 | 0426



ESSENTIALS FOR LIFE

User Manual

**Front Load
Washing Machine**

SÔLT

Purchase Details

For future reference, please record the following information which can be found on the rating plate and the date of purchase which can be found on your sales invoice.

STORE DETAILS

STORE NAME | _____

ADDRESS | _____

TELEPHONE | _____ PURCHASE DATE | _____

PRODUCT DETAILS

MODEL NO. | _____

SERIAL NO.* | _____



Welcome

Congratulations on purchasing your new Front Loader!
The Sôlt brand is proudly distributed within Australia by Residentia Group Pty Ltd.

Residentia Group

—
Head Office.
165 Barkly Ave
Burnley
Victoria 3121
Australia

—
ACN.
600 546 656

—
Online.
residentia.group

Sôlt

—
Online.
www.solt.house

—
Instagram.
[/solt.house](https://www.instagram.com/solt.house)

—
Facebook.
[/solt.appliances](https://www.facebook.com/solt.appliances)

Please refer to the warranty card at the rear of this manual for information regarding your product's parts and labour warranty, or visit us online at www.residentia.group

At Residentia Group, we are customer obsessed and our Support Team are there to ensure you get the most out of your appliance. Should you want to learn more about your front loader features, and importantly taking care of your appliance when cleaning, our Support Team are here to help.

You can use our online Support Centre at anytime by visiting <http://support.residentiagroup.com.au>, or you can contact us via calling us on 1300 11 HELP (4357).

It is important that you read through the following use and care manual thoroughly to familiarise yourself with the installation and operation requirements of your appliance to ensure optimum performance.

Again, thank you for choosing an Sôlt appliance and we look forward to being of service to you.

Kind Regards,
The Residentia Team

**This page
is intentionally
left blank**

Contents	2	Purchase Details
	3	Welcome
	6	Safety Instructions
	8	Installation
	10	Your Washing Machine
	13	Quick Start Guide
	14	Operating Instructions
	20	Cleaning & Maintenance
	22	Troubleshooting
	24	Technical Specifications
	25	Attach Your Receipt
	26	Warranty Information

Customer Care

Sôlt recommends the use of original spare parts. When contacting our customer service team, please ensure that you have the following information at hand (which can be found on your appliances' rating plate).

- Model Number
- Serial Number

T . 1300 11 4357 | E. support@residentiagroup.com.au

Safety Instructions

CONDITIONS OF USE

- This appliance is intended to be used in household and similar applications such as farm houses or by customers in serviced apartments, holiday apartments and other residential type of environments.

SAFETY INSTRUCTIONS

- Before the installation and use of the appliance, carefully read the supplied instructions.
- The manufacturer is not responsible if an incorrect installation and use causes injuries and damages.
- Always keep the instructions with your appliance for future reference.

WARNING: To prevent any damages to your and others' life or property, you have to follow the safety notes.

WARNING: Caution, risk of fire!

CHILDREN & VULNERABLE PEOPLE SAFETY

WARNING: Risk of suffocation, injury or permanent disability.

- This appliance can be used by children aged from 8 years and above and persons with reduced physical, sensory or mental capabilities or lack of experience and knowledge if they have been given supervision or instruction for the operation of the appliance by a person who is responsible for their safety.
- Children should be supervised to ensure that they do not play with the appliance.
- Keep all packaging away from children.
- Keep all detergents away from children.
- Keep children and pets away from the appliance door when it is open. Check the machine before every operation.
- Cleaning and user maintenance shall not be made by children without supervision.
- Glass door may be very hot during the operation. Keep kids and pets far away from the machine during the operation very wet rooms as well as in the rooms with explosive or caustic gas.

INSTALLATION

- Remove all the packaging.
- Do not install or use a damaged appliance.
- Obey the installation instruction supplied with the appliance.
- Old hose-sets are not to be reused and the new hose-sets supplied with the appliance are to be used.
- Before any maintenance the device, unplug the appliance from the mains.
- Make sure that the water and electrical devices must be connected by a qualified technician in accordance with the manufacturer's instructions and local safety regulations.
- Plug must be accessible after installation.
- Make sure that the floor where you install the appliance is flat, stable, heat resistant and clean.
- Always remove the plug and turn off the water supply to the appliance after every use.
- This washing machine is for indoor use only.
- Sharp and rigid items such as coins, nails and screws may cause serious damage to this appliance- always ensure pockets of clothing are empty.
- Always ensure that the drum has drained all water before opening the appliance door. If water is visible, do not open the appliance door.
- Do not install the appliance behind a lockable door, a sliding door or a door with a hinge on the opposite side, where the appliance door cannot be fully opened.
- Always be careful when you move the appliance because it is heavy. Always wear safety gloves.
- Always move the appliance vertically.
- The rear surface of the appliance must be put against the wall.
- The openings must not be obstructed by a carpet.
- This appliance should not be installed in a bathroom or similar wet rooms, as well as rooms with explosive or caustic gases.
- Washing machines with a single water inlet and should only be connected to the cold water supply outlet. Models featuring two inlet valves should be correctly connected to the hot and cold water outlets.
- The appliance can be installed as freestanding or below the kitchen counter with correct space. This washing machine is not intended to be built-in.
- When the appliance is put in its permanent position, check if it is fully level with the aid of a spirit level. If it is not, adjust the feet until it is.
- The max. inlet water pressure, in pascals. The min. inlet water pressure, in pascals.
- Remove all packages and transport bolts before using the appliance. Otherwise, serious damage may result.

Maximum inlet pressure	1.0Mpa
Minimum inlet pressure	0.05Mpa

ELECTRICAL CONNECTION

WARNING: Caution, risk of fire and electrical shock!

- To ensure your safety, power plug must be inserted into an earthed three-pole socket. Check carefully and make sure that your socket is properly and reliably earthed.
- Plug must be accessible after installation.
- Make sure that the electrical information on the rating plate agrees with the power supply. If not, contact an electrician.
- Always use a correctly installed shockproof socket.
- Do not use multi-plug adapters and extension cables.
- Make sure not to cause damage to the mains plug and to the mains cable. Should the appliance power supply cable need to be replaced, this must be carried out by our Service Centre.
- Connect the mains plug to the mains socket only at the end of the installation. Make sure that there is access to the mains plug after the installation. Do not connect the appliance plug with a power connection board.
- Do not pull the mains cable to disconnect the appliance. Always pull the mains plug.
- Do not touch the mains cable or the mains plug with wet hands.
- This appliance complies with the E.E.C. Directives.

CARE & CLEANING

WARNING: Risk of injury or damage to the appliance.

- Before maintenance, deactivate the appliance and disconnect the mains plug.
- Do not use water spray and steam to clean the appliance.
- Clean the appliance with a moist soft cloth. Only use neutral detergents. Do not use abrasive products, abrasive cleaning pads, solvents or metal objects.

TRANSPORT

- Always move the appliance cautiously. Do not use the machine door or the handle of the detergent dispenser, to lift the appliance.
- Transportation bolts should be reinstalled within the machine by a specialised person, prior to transporting the appliance.
- Ensure that all accumulated water is drained from the appliance before moving.

PRODUCT DISPOSAL

- Disconnect the appliance from the mains supply.
- Cut off the mains cable and discard it.
- Remove the door catch to prevent children and pets to get closed in the appliance.

APPLIANCE USE

WARNING: Risk of fire, explosion, electric shock or damage to the appliance.

- Use this appliance in a household only.
- **Before operating this appliance, ensure that all packaging and transport bolts have been removed.** Otherwise, serious damage can occur to the appliance.
- Before washing any clothes for the first time, the washing machine should be operated for one whole cycle without any clothes inside.
- Always unplug the machine and turn off the water supply after use. The max. inlet water pressure, in pascals. The min. inlet water pressure, in pascals.
- Do not climb up or sit on top of the appliance.
- Do not change the specification of this appliance.
- If you use fabric softener or similar products, obey the instructions on the packaging.
- Do not sit or stand on the open door.
- Obey the maximum load volume of 8.0 kg (refer to the "Program chart" chapter).
- Ensure all objects are removed from clothing pockets such as lighters and matches.
- Please only use front load washing machine detergents. Flammable and explosive or toxic solvents are forbidden for use with this appliance. Gasoline and alcohol should not be used as a detergent.
- **Do not wash or dry articles that have been cleaned in, washed in, soaked in, or dabbed with combustible or explosive substances(such as wax, oil, paint, gasoline, degreasers, dry-cleaning solvents, kerosene, etc.) This may result in fire or explosion.** If they have been in contact with any of the above, beforehand thoroughly rinse items of washing by hand.
- Never wash carpets or rugs within the appliance.
- Never refill the water by hand during washing.
- Be careful to avoid burns when the machine drains hot washing water.
- After a wash program completes, please wait two minutes before opening the door.
- If a tumble dryer is installed on top of the washing machine, use the suitable stacking kit. The stacking kit, available from your authorised vendor, can be used only with the appliance specified in the instructions, supplied with the accessory. Read it carefully before installation (Refer to the Installation leaflet).
- Never lean against the machine door.
- Please do not close the machine door with excessive force and if you find it difficult to close the door, ensure that the clothing load isn't excessive.
- Glass door may become hot during operating.

Installation

INSTALLATION POSITIONING

- Ensure that your appliance is installed on solid and flat ground, in a level position.
- Please do not place the appliance on a slope, soft carpet or wooden floor.
- Avoid positioning the appliance in direct sunlight or where there is inadequate ventilation.
- Your appliance should only be installed within an internal environment. Do not install the appliance outdoors.
- Room temperature must be above 0°C.

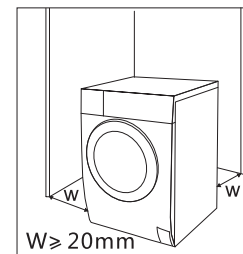

UNPACKING THE WASHING MACHINE

WARNING:

- Packaging material (e.g. Films, Styrofoam) can be dangerous for children.
- There is a risk of suffocation! Keep all packaging well away from children.

1. Remove the cardboard box and styrofoam packing.
2. Lift the washing machine and remove the base packing. Make sure the small triangle foam is removed with the bottom one together. If not, lay the unit down with side surface, then remove the small foam from the unit bottom manually.
3. Remove the tape securing the power supply cord and drain hose.
4. Remove the inlet hose from the drum.

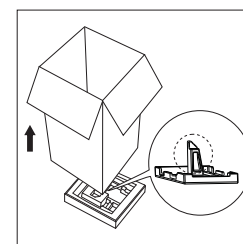

REMOVING THE TRANSPORT BOLTS

WARNING: Before using the appliance, the transport bolts must be removed from the backside of this machine. Please take the following steps to remove the bolts:

- Loosen all 4 bolts with a spanner
- Remove the bolts including the rubber parts and keep them for future use.
- Close the holes using the cover caps.
- Keep the transport bolts for future use.

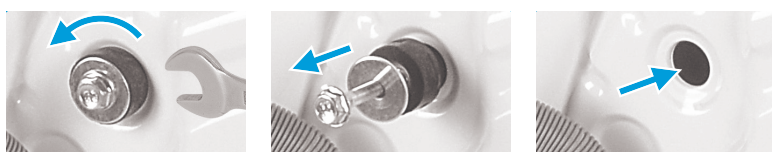
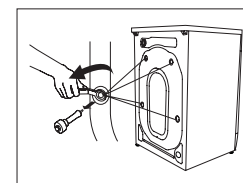

Note:

You'll need the transport bolts again if you move the appliance, so make sure you keep them in a safe place.

LEVELLING THE WASHING MACHINE

WARNING: The lock nuts on all four feet must be screwed tightly against the housing.

- If the floor is obviously uneven, your appliance feet need to be adjusted. If your appliance isn't level, it will cause your appliance to vibrate, and potentially move from its position.
- Once you've positioned your washing machine, press down from the top in all four corners to ensure that it's completely stable (i.e. not rocking in any direction). Also use a spirit level to ensure that it is completely level in all directions.
- Should you need to make adjustments, use a spanner to turn the appliance legs until it makes contact with the floor. Turn the leg using one hand and then fasten the nut up against the appliance cabinet, to lock the leg in place.
- After making any adjustments to the appliance legs, re-check to ensure it is level and no rocking occurring.

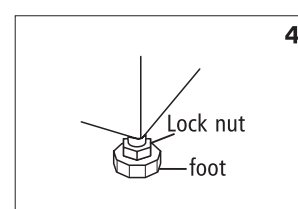
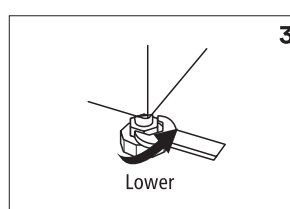
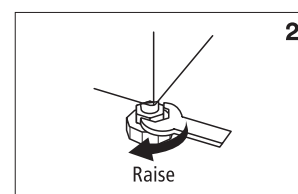
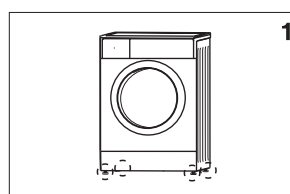

CONNECT THE WATER SUPPLY HOES PIPE

WARNING:

- To prevent leakage or water damage, follow the instructions in this chapter
- Do not kink, crush, modify or sever the water inlet hose!

Connect the water supply hose to the water inlet valve and a water tap with cold water as indicated.



Note: Connect manually, do not use tools.
Check if the connections are tight.

POSITION THE DRAIN HOSE

The outlet hose (used to drain the discharged water) is to be ideally connected to the relevant waste pipe, although it can also be positioned to drain into a sink/trough.

Note that the outlet hose has a minimum outlet position of 60cm and a maximum position of 100cm (as illustrated below).

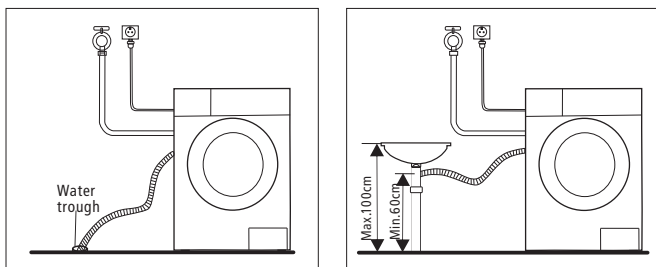

WARNING:

- If you are positioning the outlet hose to drain into a sink or trough, please ensure that it is fixed in place and that the sink remains unblocked at all times.
- If drain hose is too long, do not force it into washing machine as it will cause abnormal noises.

APPLYING THE ACOUSTIC SPONGE

Note: Please make sure to assemble the acoustic sponges, which can effectively reduce the noise caused by the machine while working, in order to provide you with a more peaceful and quiet living environment.

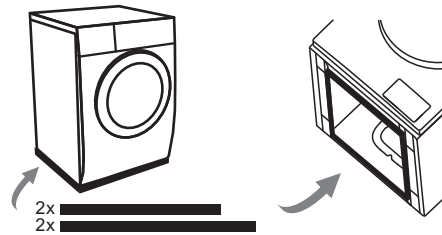

1. Lie the machine laid on the floor, using some soft material like foam or clothes between the machine and floor for protection;
2. Stick the 2× longer sponges to the longer bottom edges of machine, and the 2× shorter sponges to the shorter bottom edges.

Your Washing Machine

PRODUCT COMPONENTS

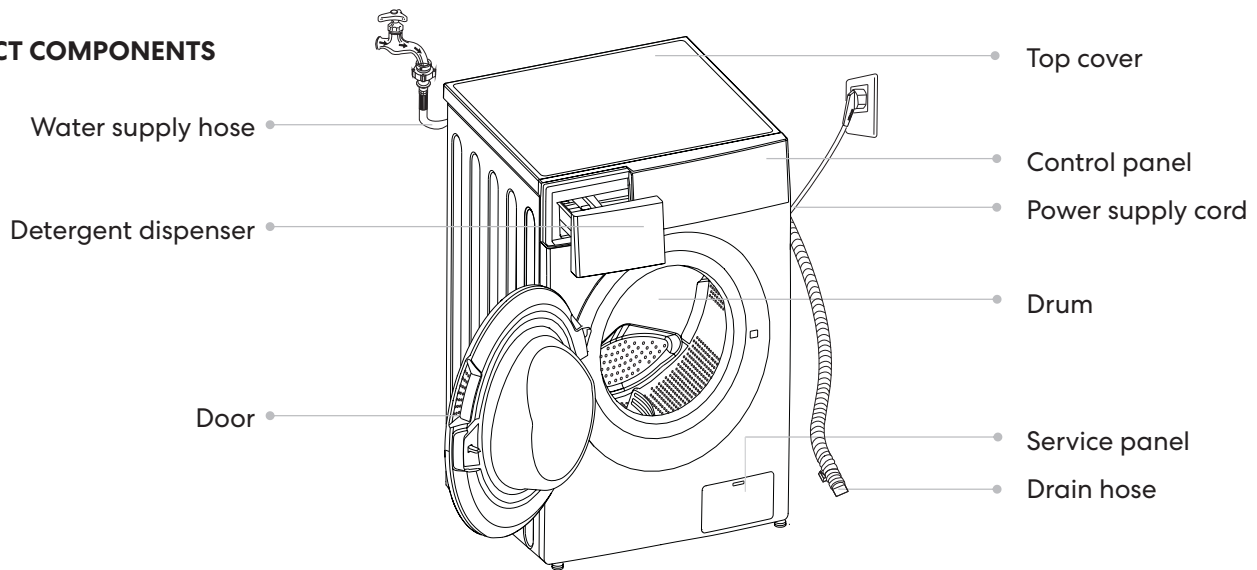

CONTROL PANEL

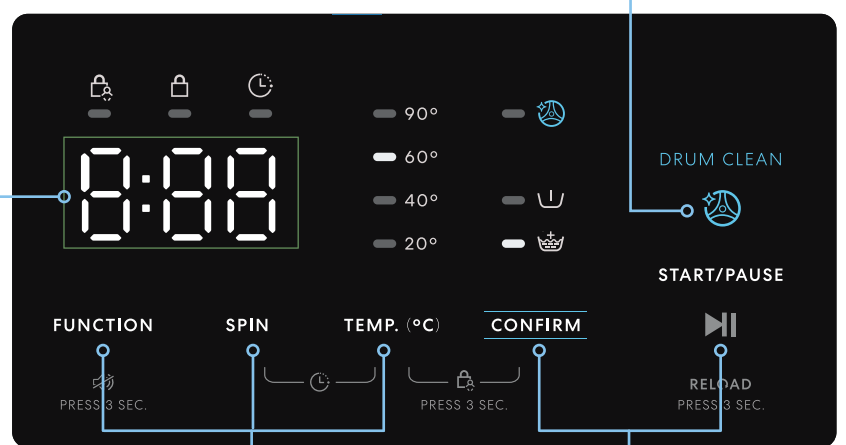
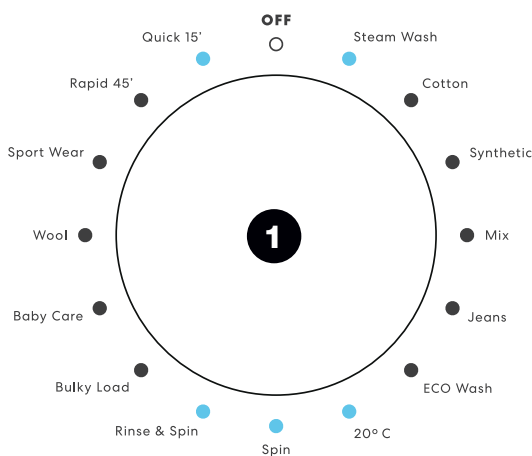

1 Program selection dial:

Different washing cycles can be selected according to the users need and the type of laundry to be washed.

2 Display:

The display shows the setting, estimated program time remaining, options and status messages of your washer. This display will remain on through the cycle.

Wash Time	Delay Time
1:25	2h
Speed	Error
400	E30
End	
End	

3 Additional function buttons:

These buttons are used for setting additional functions to your cycle.

4 Drum Clean:

Specially set in the machine to clean the drum and tube.

5 Confirm & Start/Pause buttons:

Touch the 'Confirm' button, followed by 'Start/Pause' button (within a minute of pressing 'Confirm') to begin the cycle.

This updated process prevents accidental activation. Press and hold the 'Start/Pause' button for 3 seconds to use the Reload function.

Note: The images in this user manual are for explanatory purposes only.

Your Front Loader Washing Machine may appear slightly different, however the functions remain the same.

DISPLAY SCREEN

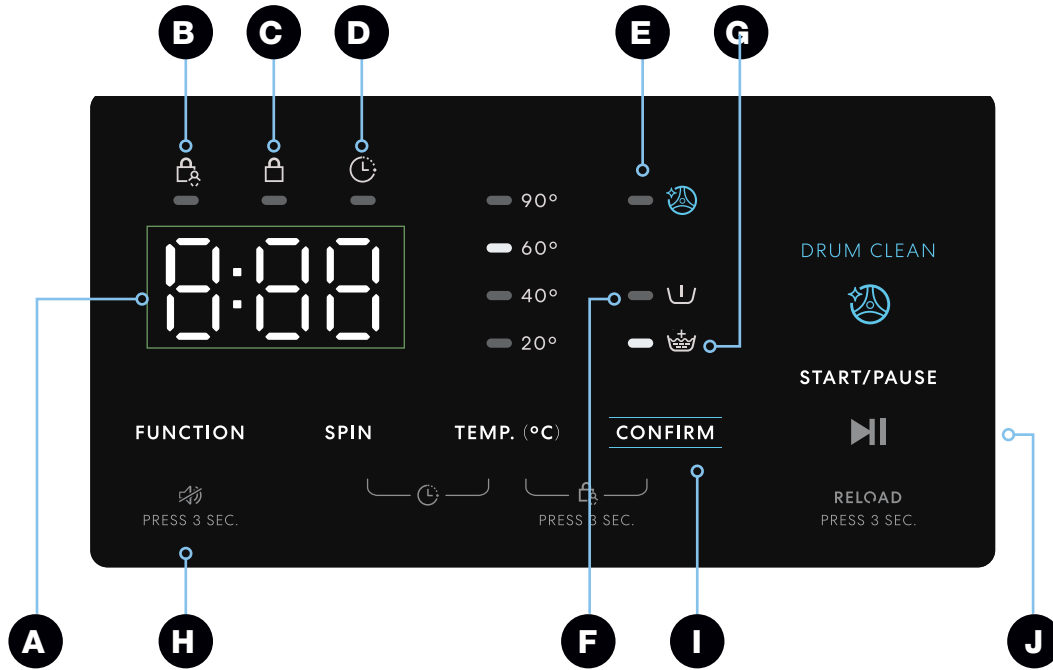

A		Display	E		Drum Clean
B		Child lock	F		Pre Wash
C		Door lock	G		Extra Rinse
D		Delay	H		Mute
I	CONFIRM	Confirm Button	J		Start/Pause Button

ACCESSORIES

1 Transport hole plug



2 Supply hose cold water



3 Owner's manual



4 Acoustic sponges



5 Quick Start Guide



Your Washing Machine (Continued)

DETERGENT DISPENSER

The detergent drawer of your washing machine is split into three compartments:

- I Pre-wash detergent compartment.
Refer to the Wash Programs Table to see which programs utilise a pre-wash.
- II Main detergent compartment.
This is the common detergent drawer.
- ☼ Softener compartment.

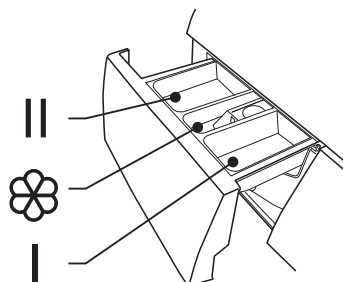

WARNING: Liquid detergent is only required in compartment “I” after selecting the Pre-Wash function.

Program	Pre Wash	Main Detergent	Softener
Steam Wash	Optional	Required	Optional
Cotton	Optional	Required	Optional
Synthetic	Optional	Required	Optional
Mix	Optional	Required	Optional
Jeans	Optional	Required	Optional
ECO Wash	—	Required	Optional
20° C	—	Required	Optional
Spin	—	—	—
Rinse & Spin	—	—	Optional
Bulky Load	Optional	Required	Optional
Baby Care	Optional	Required	Optional
Wool	—	Required	Optional
Sport Wear	Optional	Required	Optional
Rapid 45'	—	Required	Optional
Quick 15'	—	Required	Optional

Note:

- When using granulated detergent or additive, before they are poured into the detergent box, it is suggested to mix water for dilution and then to pour into the detergent box. This prevents the inlet of the detergent box from blockages and overflowing.
- Please choose a suitable type of detergent for the various washing temperature to get the best washing performance with less water and energy consumption.

Quick Start Guide

QUICK START:

Follow the procedure below to operate your washing machine.

CAUTION:

- Before washing, please make sure it's installed properly.
- Your appliance was thoroughly checked before it left the factory. To remove any residual water and to neutralise potential odours, it's recommended to clean your appliance before first use. For this reason, start the Cotton program at 90°C without laundry and detergent

BEFORE WASHING

1. Install your washing machine.
2. Plug in the power supply.
3. Turn on the water supply.
4. Open the door and load in the laundry.
5. Close the machine door.
6. Measure the detergent and pour in the appropriate amount
7. Power on the washing machine.
8. Select the desired program.
9. Select any additional functions if required.
10. Press the Confirm button and then press the Start/Pause button to begin.
11. Completion of the washing cycle.
 - At the completion of a wash program, the washing machine will make an audible tone and "End" will be displayed on the screen.
12. Turn off the water supply
 - Although the washing machine would be switched off, the power outlet should be switched off and the plug should be pulled out for safety reasons.

Operating Instructions

PREPARATION BEFORE WASHING CLOTHES

Please follow these steps carefully to avoid trouble with your washing machine and damaging your clothing.

Washing Considerations

- The working condition of the washer should be (0-40)°C. If used under 0°C, the inlet valve and draining system may be damaged. If the machine is placed under condition of 0°C or less, then it should be transferred to normal ambient temperature to ensure the water supply hose and drain hose are not frozen before use.
- Please check the labels and the explanation of using detergent before wash. Use non-foaming or less-foaming detergent suitable for machine washing properly.
- New clothes in particular, can leach colour onto other clothing items, particularly whites. Consider washing these and bright colours separately.
- Stained clothing should be treated with a stain remover, prior to washing.
- Temperature sensitive clothes should be washed in accordance with their care direction label. Otherwise distortion and/or changes in colour could occur.
- Never allow washing to sit in the machine for a long period of time- particularly when wet. Clothes can become mouldy and develop an odour.
- Certain clothing cannot be washed in a washing machine and their care directions may state dry cleaning or hand washing required.
- Wrinkle style clothes, embossed clothes, resin clothes, etc may become distorted when immersed in water.
- Avoid washing clothes without care direction labels within the appliance, to be safe.
- Always remove all items from clothing pockets, as hard items can cause damage to the appliance.
- Try to wash clothing colours and sizes in like loads, as this will improve the effectiveness of the washing and results.
- Close all clothing zips and ensure all buttons are fastened securely.
- Delicate items such as bras, handkerchiefs and ties should be washed within a special washing bag, to prevent damage to themselves and other clothes.
- When washing a large single item that could become heavy (i.e. a towel or jacket), it can cause the appliance to become unbalance during its spin cycle. Therefore it's recommended to add one or two more clothing items to help the machine balance.
- Try to remove any pet hair, dust and stains from clothing prior to washing.
- Baby clothing should be washed separately.
- Clothing that gets easily "fuzzed" or loses fibres easily, should be washed separately.
- Black clothing items should be washed separately.
- Do not wash waterproof materials within the washing machine.

Pay Attention to Detergents

- Only use suitable front load washing machine detergents with this appliance. Powders and liquid detergents only.
- Only ever use the recommended quantity of detergent, as per the manufacturer's guidelines, as an excessive quantity can cause excessive bubbles and overflow to occur.
- It can also result in detergent residue remaining on the clothing after completion of the wash cycle.

WARNING: Always keep detergents and additives out of reach from children.

Clothing Classifications

The symbol types on care labels are typically classified into the following textiles: Cotton, Blended Fibre, Synthetic Fibre, Silk, Wool and Artificial Fibre.

Confirm the Washing Capacity

Never load the machine with excessive weights, as it will affect your washing results.

WASHING CLOTHES FOR THE FIRST TIME

Before washing any clothes, please perform one cycle without clothes inside as follows:

- Connect the power source and water.
- Insert a small amount of detergent into the detergent drawer and close it.
- Select a Cotton program at 90°C.
- Press the “Confirm” button.
- Press the “Start/Pause” button on the appliance.
- Allow the program to complete and your washing machine is now ready for use.

SELECTING A PROCEDURE

You should select your washing program based on the type of clothing, quantity and dirtiness level, in combination with the following temperature table.

Temperature Mode	Application
90° C	Seriously soiled clothing, pure white cotton (I.e. bed linen, towels, table cloths, etc)
60° C	Moderately soiled clothing, cotton and synthetic articles with certain decolourising degree (I.e. shirts, pajamas, etc)
40° C, 20° C, Cold Water	Lightly soiled clothing, synthetics and wool

To select a program:

- First turn the Program Selection Dial to the corresponding wash program, according to the type of textiles being washed.
- Secondly, select the desired temperature based on the level of dirtiness.

Note: Generally the higher the temperature, the more power that's consumed.

- Finally, select your desired spin speed. The higher the spin speed, the drier the textiles will be at completion, however more delicate textiles will be more wrinkled. Delicate textiles should be set with a lower spin speed.

Selecting the main washing program depends on the types of clothing to be washed, as follows:

Steam Wash

Select this function for steam-assisted washing. The higher temperature makes it easier to break down stains more effectively, getting rid of allergens and bacteria whilst also reducing the need to iron wrinkles in clothing.

Cotton

Suitable for hard wearing and heat resistant textiles made from cotton or linen. To increase the washing results the main washing time is increased.

Synthetic

The procedure is shorter compared with that for cottons and the washing intensity is relatively gentle. It is recommended for washing synthetic articles, for example: shirts, coats, etc.

Mix

You can select this procedure for washing durable clothes, that typically require more wash time and intensity. It is ideal for any “daily” clothing such as cotton, including sheets, pillowcases, bathrobes and underwear.

Jeans

Suitable for durable garments such as denim.

ECO Wash

This procedure saves energy and limits the washing temperatures between 20°C–60°C. The default set temperature is 20°C. Use with a small quantity of clothes which are only lightly dirty.

20° C

You can select this procedure for washing delicate items where the care label suggests Cold Wash. To be used with only a small quantity of clothing at a time with light soiling only. The default temperature of this washing procedure is 20° C.

Spin

This procedure provides a spin only option. Residual soapy water shall be drained out before spinning.

Rinse & Spin

This procedure provides a short rinse cycle followed by a spin cycle.

Operating Instructions (Continued)

Bulky Load

You can select this procedure for washing bulky items.

Baby Care

Washing the baby's clothes, it can make the baby's wear cleaner and make the rinse performance better to protect the baby skin.

Wool

You can select this procedure to wash wool textiles labeled with "Machine Wash". Please select the proper washing temperature according to the clothings care label. Furthermore, the proper detergent amount should be used for wool textiles, which is generally less than normal wash loads.

Sport Wear

You can select this procedure for washing sport and active-wear clothing.

Rapid 45'

This procedure is suitable for washing a small quantity of clothes without heavy soiling.

Quick 15'

You can select this procedure for washing a small quantity of clothing, where items are only lightly soiled.

ADDITIONAL WASH OPTIONS

Delay Function

The Delay function can be set where the delay is 0–24 Hrs.

To set the Delay function:

- Select a wash program;
- Press "Spin" and "Temp." buttons together at the same time until it reaches your desired Delay setting to choose the time;
- Press Confirm button, followed by the Start/Pause button to commence the delay operation.

To Cancel the Delay function:

- Press "Spin" and "Temp." buttons together at the same time until the display shows OH.
It should be pressed prior to starting the program.
If the program has already started, turn off the machine to reset.

Spin Function

Select this button to manually set the spin speed of your wash program.

GGNFLW6002W: 0–400–600–800–1000–1200

GGNFLW8002W: 0–400–600–800–1000–1200–1400

GGNFLW9002B: 0–400–600–800–1000–1200–1400

Temperature Function

Select this button to manually set the temperature of your wash program.

Cold – 20°C – 40°C – 60°C – 90°C

Pre Wash Function

Press the Function button until the Pre Wash function is set.

Extra Rinse Function

Press the Function button until the Extra Rinse function is set.

Drum Clean

After 25 washes, the Drum Clean light will illuminate to remind you to run this cycle. This program provides a 90°C high temperature sterilisation cycle to clean the drum and tube. When this procedure is performed, clothes or other items should not be added. Use this program regularly according to your needs.

To cancel the reminder for another 25 cycles, press and hold the Drum Clean button for 3 seconds.

Reload (Add a Garment) Function

This function can be executed during operation of a washing program. When the drum of the machine is still in motion and/or there is a large amount of water inside, the machine will not allow the door to be opened.

To use the Reload function:

- Press and hold the Start/Pause button for 3 seconds.
- Once the drum stops rotating, the door will unlock and allow you to open.
- Add your additional clothing items and close the door.
- Press the Confirm button.
- Press the Start/Pause button once again to continue the wash program.

Child Lock

To avoid the washing procedure being altered by children, you can activate the child lock function. All buttons and dials won't alter the machines settings, however the On/Off button will still function. When Child Lock is activated, "CL" will display alternating with the remaining wash time on the screen. At the completion of your cycle, "CL" and "END" will alternate on the display for 10 seconds, then the indicator will flash for 3 seconds.

Note:

If the machine is switched off when Child Lock is active, it will remain in Child Lock mode when switched back on.

To activate or deactivate the Child Lock:

- Press and hold the "Temp." and "Confirm" buttons together at the same time for 3 seconds, whilst the machine is operating.
- The machine will make an audible tone to let you know that the Child Lock is activated or deactivated.

Note:

At the completion of a wash program, the child lock will become deactivated automatically.

Mute function

This function allows you to turn the audible tone on or off, to indicate that your washing program is complete. By default, the audible signal is set to On.

When the Mute function is on, your appliance will make an audible tone when:

- The additional wash functions are pressed.
- If the washing machine is operating and the program selector knob is turned, the appliance will make an audible tone to alert the user that an invalid choice has been made.
- At the completion of a washing program, an audible tone will sound.

To activate or deactivate the Mute function:

- Press and hold the "Function" buttons for 3 seconds.

Confirm function

Press this button before starting the wash cycle each time.

The steps are as follows:

- Select a program and any additional wash options.
- Select a Confirm
- Press Start/Pause within 1 minute after confirmation to begin the wash cycle.

Note:

After pressing Confirm, the machine will be locked and cannot open unless the machine is restarted.

Operating Instructions (Continued)

Washing Program Table

GGFLW6002B & GGFLW6002W

Program	Load (kg)	Default Temp (° C)	Default Speed (RPM)	Default Time
Steam Wash	3.0	40	1000	1:26
Cotton	6.0	40	1000	1:28
Synthetic	3.0	40	1000	1:25
Mix	6.0	40	1000	0:58
Jeans	6.0	40	800	1:40
ECO Wash	6.0	20	1000	0:59
20° C	3.0	20	1000	1:01
Spin	6.0	-	1000	0:12
Rinse & Spin	6.0	-	1000	0:20
Bulky Load	6.0	40	1000	1:48
Baby Care	6.0	60	1000	2:01
Wool	2.0	40	600	1:07
Sport Wear	3.0	20	800	0:47
Rapid 45'	2.0	20	800	0:45
Quick 15'	2.0	Cold	800	0:15

- Energy test program: ECO Wash, Temp: 60° C.
Speed: the highest speed; Other as the default.
Half load for 6.0kg machine: 3.0kg.
- “ECO Wash” is the standard washing programs to which the information in the label and the fiche relates, and they are suitable to clean normally soiled cotton laundry and that they are the most efficient programs in terms of combined energy and water consumptions for washing that type of cotton laundry, that the actual water temperature may differ from the declared cycle temperature.

Note:

The parameters in this table are only for user's reference.

The actual parameters maybe different with the parameters in above mentioned table.

Washing Program Table

GGFLW8002W

Program	Load (kg)	Default Temp (° C)	Default Speed (RPM)	Default Time
Steam Wash	4.0	40	1000	1:26
Cotton	8.0	40	1000	1:28
Synthetic	4.0	40	1000	1:25
Mix	8.0	40	1000	0:58
Jeans	8.0	40	800	1:40
ECO Wash	8.0	20	1000	0:59
20° C	4.0	20	1000	1:01
Spin	8.0	-	1000	0:12
Rinse & Spin	8.0	-	1000	0:20
Bulky Load	8.0	40	1000	1:48
Baby Care	8.0	60	1000	2:01
Wool	2.0	40	600	1:07
Sport Wear	4.0	20	800	0:47
Rapid 45'	2.0	20	800	0:45
Quick 15'	2.0	Cold	800	0:15

- Energy test program: ECO Wash, Temp: 60° C.
Speed: the highest speed; Other as the default.
Half load for 8.0kg machine: 4.0kg.
- “ECO Wash” is the standard washing programs to which the information in the label and the fiche relates, and they are suitable to clean normally soiled cotton laundry and that they are the most efficient programs in terms of combined energy and water consumptions for washing that type of cotton laundry, that the actual water temperature may differ from the declared cycle temperature.

Note:

The parameters in this table are only for user's reference.

The actual parameters maybe different with the parameters in above mentioned table.

Operating Instructions (Continued)

Washing Program Table

GGFLW9002B

Program	Load (kg)	Default Temp (° C)	Default Speed (RPM)	Default Time
Steam Wash	4.5	40	1000	1:26
Cotton	9.0	40	1000	1:28
Synthetic	4.5	40	1000	1:25
Mix	9.0	40	1000	0:58
Jeans	9.0	40	800	1:40
ECO Wash	9.0	20	1000	0:59
20° C	4.5	20	1000	1:01
Spin	9.0	-	1000	0:12
Rinse & Spin	9.0	-	1000	0:20
Bulky Load	4.5	40	1000	1:48
Baby Care	9.0	60	1000	2:01
Wool	2.0	40	600	1:07
Sport Wear	9.0	20	800	0:47
Rapid 45'	2.0	20	800	0:45
Quick 15'	2.0	Cold	800	0:15

- Energy test program: ECO Wash, Temp: 60° C.
Speed: the highest speed; Other as the default.
Half load for 9.0kg machine: 4.5kg.
- “ECO Wash” is the standard washing programs to which the information in the label and the fiche relates, and they are suitable to clean normally soiled cotton laundry and that they are the most efficient programs in terms of combined energy and water consumptions for washing that type of cotton laundry, that the actual water temperature may differ from the declared cycle temperature.

Note:

The parameters in this table are only for user's reference.

The actual parameters maybe different with the parameters in above mentioned table.

Cleaning & Maintenance

CLEANING PROCEDURES

WARNING: Before beginning any cleaning or maintenance, always ensure the appliance is switched off, the power plug is removed from the power outlet and the water supply has been closed.

CLEANING THE WASHING MACHINE EXTERIOR

Proper maintenance of your washing machine will keep it looking as new and extend its working life.

- The exterior surface can be cleaned with household cleaners and a soft damp cleaning cloth.
- If there is any residual water at the completion of a washing program, please use a cloth to wipe it off immediately.

Note: Never use solvents or harsh cleaning chemicals on your washing machine's exterior.

CLEANING THE INTERNAL DRUM

Should any rust form on the inside drum (i.e. water was left to sit for an extended period of time), please remove immediately using a chlorine free detergent. Never use steel wool or a harsh abrasive.

Note: Never place laundry in the washing machine when performing the Drum Clean program.

CLEANING THE DOOR SEAL AND GLASS

Wipe the glass and seal after each wash to remove lint and stains. If lint builds up it can cause leaks. Remove any coins, buttons and other foreign objects from the seal after each wash.

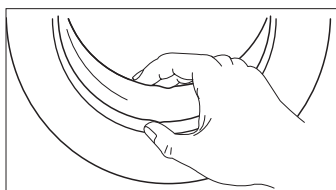

FROZEN WASHING MACHINE

Should the temperature drop below zero and your washing machine becomes frozen, you should:

- Disconnect the power supply for the washing machine.
- Wash the tap connection with warm water, to help you to disconnect the inlet pipe.
- Remove the inlet pipe and immerse in warm water (i.e. within a bathtub).
- Pour some warm water into the washing machine drum and wait for approximately 10 minutes.
- Reconnect the inlet pipe to the tap and washing machine and open the water supply.
- Wait until the room's ambient temperature returns to above 0°C before trying to operate the washing machine.

CLEANING THE DETERGENT DRAWER

You should periodically follow these steps to ensure the detergent drawer remains clean.

- Press down on the arrow, located on the cover for the fabric softener compartment of the detergent drawer and remove the drawer out of the recess.
- Clean the inside of the recess with a brush.
- Lift the softener cover off the dispenser drawer and wash both items with water.
- Re-install the fabric softener compartment cover into the detergent drawer, and push the drawer back into position.

Note:

- Do not use abrasive or caustic agents to clean the plastic parts.
- Clean the detergent dispenser every 3 months to ensure the normal operation of the appliance.

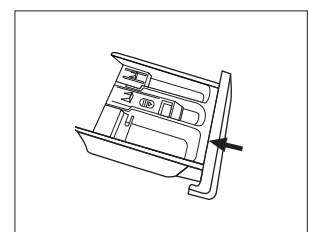
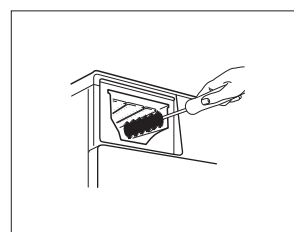
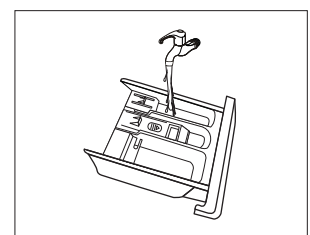
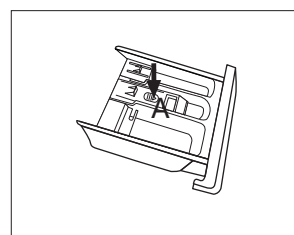

CLEANING THE INLET FILTER

You should clean the inlet filter every 3 months, or if you find that insufficient water is being supplied to your washing machine when the supply tap is open.

To clean the inlet filter:

- Close the water supply tap and remove the water supply hose from it.
- Clean the filter with a brush.
- Unscrew the water supply hose from the rear of the machine. Pull out the filter with long pliers.
- Use a brush to clean the filter.
- Reinstall the filter to the water inlet and reconnect the water supply hose.

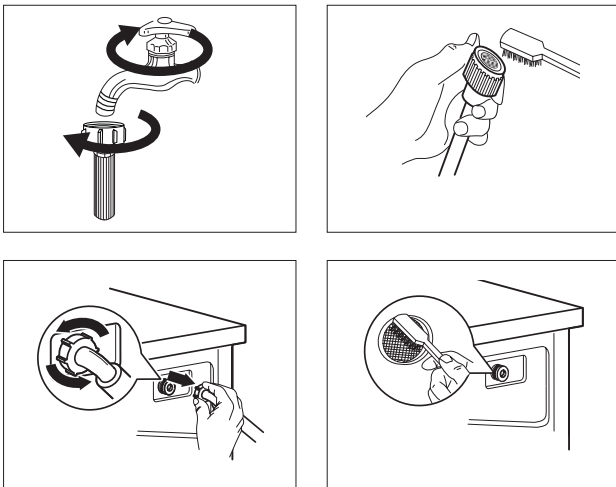

CLEANING THE DRUM PUMP FILTER (REMOVING FOREIGN OBJECTS)

WARNING: To avoid the risk of an electric shock, always remove the power plug from the power outlet before cleaning the Drain Pump filter.

Periodically you should clean the drain pump filter to ensure normal operation of your washing machine. The type of washing, frequency and soil level of your washing cycles will alter how often this procedure needs to be undertaken, however you should inspect the filter regularly.

Should your washing machine not empty and/or spin, or your machine makes unusual noises during operation, your Drain Pump filter could be blocked. Follow this procedure to check or remove any foreign objects.

- After disconnecting the power, open the filter cover at the front base of your washing machine.
- Unscrew the filter in an anti-clockwise direction and remove any foreign objects.
- Re-install the filter and close the service panel. Leaking may occur if it is not re-installed correctly.

WARNING: Never remove the pump cover when the washing machine is in operation, always wait until the appliance has finished and is empty. There can be hot water within the pump, so be careful to avoid burns, should it have operated recently. When replacing the cover, be careful to ensure it is closed securely.

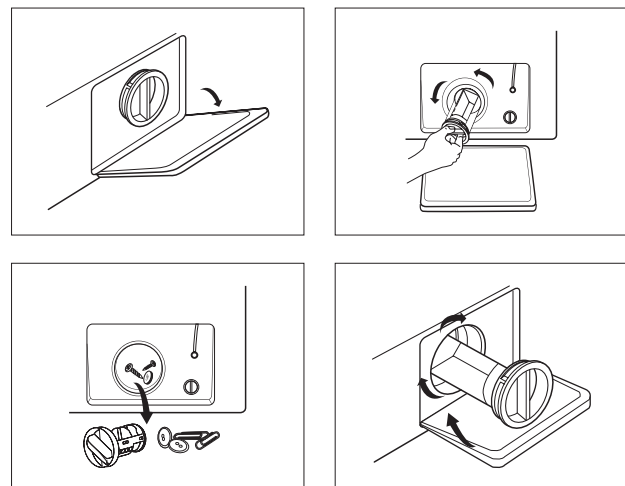

Troubleshooting

WARNING

Only authorised technicians can carry out repairs.

Before contacting our customer service team, please refer to the table below to see if your fault can be fixed by yourself. Should a service technician visit be arranged and its found there are no faults with the appliance, a call out charge will apply.

PROBLEM	SOLUTION
Washing Machine won't start-up	<ul style="list-style-type: none">• Check that the mains plug is inserted and switched on at the power point.• Check that the door is closed securely or if there are clothes preventing it from closing.• Check that the relevant fuse hasn't blown.• Check that the On/Off button has been pressed.• Check that the water supply tap has been opened.
Door won't open	<ul style="list-style-type: none">• The machine's safety protection is in operation. Disconnect the power and reconnect the power.
Water is leaking	<ul style="list-style-type: none">• The inlet pipe or outlet hose may not be tightened or blocked.• Check and fasten all water connection pipes.• Inlet or Outlet hoses may be damaged. Please check.
Detergent residues remain in the detergent drawer	<ul style="list-style-type: none">• Ensure you are using a correct amount of detergent.• Follow the cleaning steps to remove any damp residual detergent from the drawer.
Display isn't lighting up	<ul style="list-style-type: none">• Check that the power isn't disconnected.• PC board may have issues. Please contact our customer service team.
Washing results aren't to expectations	<ul style="list-style-type: none">• Ensure you are using a sufficient amount of detergent.• Ensure the correct quantity of clothes are being used depending on the wash program selected.• Ensure you are using the correct wash program to suit the clothing and level of dirtiness.• Try using an alternative detergent.
Washing machine is making an abnormal noise or vibrating	<ul style="list-style-type: none">• Ensure the washing machine is level.• Ensure that all transportation bolts have been removed.• Ensure the appliance has been installed on a solid and level floor.• Ensure that all legs are making contact with the floor and adjust as required.• Follow the Drain Pump cleaning procedure and ensure there are no foreign objects.

Note: If the above steps don't resolve your issue or you cannot resolve the fault by yourself:

- Turn the appliance off.
- Switch off the appliance at the power outlet and remove the plug.
- Call our customer service team.

INDICATION	PROBLEM	SOLUTION
E30	Door is not closed properly	<ul style="list-style-type: none"> Restart after the door is closed Check if there are clothes or washing articles stuck
E10	Water injecting problem while washing	<ul style="list-style-type: none"> Check if the water pressure is too low Straighten the water pipe Check if the inlet valve filter is blocked
E21	Overtime water draining	<ul style="list-style-type: none"> Check if the drain hose is blocked
E12	Water overflow	<ul style="list-style-type: none"> Restart the washer

Note: If the above steps don't resolve your issue or you cannot resolve the fault by yourself:

- Turn the appliance off.
- Switch off the appliance at the power outlet and remove the plug.
- Call our customer service team.

Technical Specifications

Below outlines the technical specifications for your Washing Machine.

Model	GGSFLW6002B	GGSFLW6002W	GGSFLW8002W	GGSFLW900B
Washing Capacity	6.0kg	6.0kg	8.0kg	9.0kg
Dimensions (W × D × H mm)	595 × 470 × 850	595 × 470 × 850	595 × 533 × 850	595 × 589 × 850
Net Weight	55kg	55kg	60kg	61kg
Rated Power	2000W	2000W	1950W	2000W
Power Supply	220-240V, ~50Hz, 10Amp	220-240V, ~50Hz, 10Amp	220-240V, ~50Hz, 10Amp	220-240V, ~50Hz, 10Amp
Standard Water Pressure	0.05MPa~1.0MPa	0.05MPa~1.0MPa	0.05MPa~1.0MPa	0.05MPa~1.0MPa

Technical Specifications (Continued)

TESTING METHODS:

GGFLW6002B & GGFLW6002W

ADDITIONAL INFORMATION FOR STANDARD PERFORMANCE TESTING:
(AS/NZS 2040.1:2005+Amdt1-2007+Amdt2-2009)

1. Water connections: Cold water connection
2. Water supply pressure: 320 kPa
3. Warm wash Program: ECO Wash, 60°C, Spin 1200 RPM, Display: 4:50
Cold wash program: Cotton Cold (no temperature display is cold wash)
4. Detergent type: Drum detergent
5. Detergent quantity: Default
6. Adding detergent:
The detergent is dissolved and added as Paragraph B7.3 of AS/NZS 2040.1
The detergent shall be dissolved in 1 L of water
7. Anti-sudsing agent: Max
8. Test load mass: 6.0kg
9. Water consumption: 61L
10. Test Voltage: 220-240V~,50Hz

GGFLW8002W

ADDITIONAL INFORMATION FOR STANDARD PERFORMANCE TESTING:
(AS/NZS 2040.1:2005+Amdt1-2007+Amdt2-2009)

1. Water connections: Cold water connection
 2. Water supply pressure: 320 kPa
 3. Warm wash Program: ECO Wash 60°C, 1400 RPM, Display: 6:32
Cold wash program: Cotton Cold (no temperature display is cold wash)
 4. Detergent type: Drum detergent
 5. Detergent quantity: Default
 6. Adding detergent:
The detergent is dissolved and added as Paragraph B7.3 of AS/NZS 2040.1
The detergent shall be dissolved in 1 L of water
 7. Anti-sudsing agent: Max
 8. Test load mass: 8.0kg
 9. Water consumption: 68L
- Test Voltage: 220-240V~,50Hz

GGFLW9002B

ADDITIONAL INFORMATION FOR Standard performance TESTING:
(AS/NZS 2040.1:2005+Amdt1-2007+Amdt2-2009)

- Water Connections: Cold water connection
- Water Supply Pressure: 320 kPa
- Warm Wash Program: ECO Wash, 60°C, Spin 1400 RPM, Display: 6:56
Cold Wash Program: Cotton Cold (no temperature display is cold wash)
- Detergent Type: Drum detergent
- Detergent Quantity: Default
- Adding Detergent:
The detergent is dissolved and added as Paragraph B7.3 of AS/NZS 2040.1
The detergent shall be dissolved in 1 L of water
- Anti-sudsing Agent: Max
- Test Load Mass: 9.0kg
- Water Consumption: 91L
- Test Voltage: 220-240V~,50Hz

**Attach your receipt
to this page**



Warranty Information

WARRANTY TERMS & CONDITIONS LAUNDRY

This document sets out the terms and conditions of the product warranties for Residentia Group Appliances. It is an important document. Please keep it with your proof of purchase documents in a safe place for future reference should you require service for your Appliance.

1. IN THIS WARRANTY

- (a) 'acceptable quality' as referred to in clause 10 of this warranty has the same meaning referred to in the ACL;
 - (b) 'ACL' means Trade Practices Amendment (Australian Consumer Law) Act (No.2) 2010;
 - (c) 'Appliance' means any Residentia Group product purchased by you accompanied by this document;
 - (d) 'ASR' means Residentia Group authorised service representative;
 - (e) 'Residentia Group' means Residentia Group Pty Ltd of 165 Barkly Ave, Burnley VIC 3121, ACN 600 546 656 in respect of Appliances purchased in Australia;
 - (f) 'major failure' as referred to in clause 10 of this warranty has the same meaning referred to in the ACL and includes a situation when an Appliance cannot be repaired or it is uneconomic for Residentia Group, at its discretion, to repair an Appliance during the Warranty Period;
 - (g) 'Warranty Period' means:
 - (i) where the Appliance is used for personal, domestic or household use (i.e. normal single family use) as set out in the instruction manual, the Appliance is warranted against manufacturing defects for 24 months, following the date of original purchase of the Appliance;
 - (h) 'you' means the purchaser of the Appliance not having purchased the Appliance for re-sale, and 'your' has a corresponding meaning.
2. This warranty only applies to Appliances purchased and used in Australia and is in addition to (and does not exclude, restrict, or modify in any way) any non-excludable statutory warranties in Australia.
 3. During the Warranty Period Residentia Group or its ASR will, at no extra charge if your Appliance is readily accessible for service, without special equipment and subject to these terms and conditions, repair or replace any parts which it considers to be defective. Residentia Group or its ASR may use remanufactured parts to repair your Appliance. You agree that any replaced Appliances or parts become the property of Residentia Group. This warranty does not apply to light globes, batteries, seals, filters or similar perishable parts.
 4. Parts and Appliances not supplied by Residentia Group are not covered by this warranty.

5. You will bear the cost of transportation, travel and delivery of the Appliance to and from Residentia Group or its ASR. If you reside outside of the service area, you will bear the cost of:
 - (a) travel of an authorised representative;
 - (b) transportation and delivery of the Appliance to and from Residentia Group or its ASR, in all instances, unless the Appliance is transported by Residentia Group or its ASR, the Appliance is transported at the owner's cost and risk while in transit to and from Residentia Group or its ASR.
6. Proof of purchase is required before you can make a claim under this warranty.
7. You may not make a claim under this warranty unless the defect claimed is due to faulty or defective parts or workmanship. Residentia Group is not liable in the following situations (which are not exhaustive):
 - (a) the Appliance is damaged by:
 - (i) accident
 - (ii) misuse or abuse, including failure to properly maintain or service
 - (iii) normal wear and tear
 - (iv) power surges, electrical storm damage or incorrect power supply
 - (v) incomplete or improper installation
 - (vi) incorrect, improper or inappropriate operation
 - (vii) insect or vermin infestation
 - (viii) failure to comply with any additional instructions supplied with the Appliance;
 - (b) the Appliance is modified without authority from Residentia Group in writing;
 - (c) the Appliance's serial number or warranty seal has been removed or defaced;
 - (d) the Appliance was serviced or repaired by anyone other than Residentia Group, an authorised repairer or ASR.
8. This warranty, the contract to which it relates and the relationship between you and Residentia Group are governed by the law applicable where the Appliance was purchased.
9. To the extent permitted by law, Residentia Group excludes all warranties and liabilities (other than as contained in this document) including liability for any loss or damage whether direct or indirect arising from your purchase, use or non use of the Appliance.
10. For Appliances and services provided by Residentia Group in Australia, the Appliances come with a guarantee by Residentia Group that cannot be excluded under the Australian Consumer Law. You are entitled to a replacement or refund for a major failure and for compensation for any other reasonably foreseeable loss or damage. You are also entitled to have the Appliance repaired or replaced if the Appliance fails to be of acceptable quality and the failure does not amount to a major failure. The benefits to you given by this warranty are in addition to your other rights and remedies under a law in relation to the Appliances or services to which the warranty relates.
 11. At all times during the Warranty Period, Residentia Group shall, at its discretion, determine whether repair, replacement or refund will apply if an Appliance has a valid warranty claim applicable to it.
 12. Missing parts are not covered by warranty. Residentia Group reserves the right to assess each request for missing parts in a case by case basis. Any parts that are not reported missing in the first week after purchase will not provide free of charge.
 13. To enquire about claiming under this warranty, please follow these steps:
 - (a) carefully check the operating instructions, user manual and the terms of this warranty;
 - (b) have the model and serial number of the Appliance available;
 - (c) have the proof of purchase (e.g. an invoice) available;
 - (d) telephone the numbers shown below.
 14. You accept that if you make a warranty claim, Residentia Group and its ASR may exchange information in relation to you to enable Residentia Group to meet its obligations under this warranty.

IMPORTANT

Before calling for service, please ensure that the steps in point 13 have been followed.

Telephone contacts

- ▶ Service: Please call 1300 11 HELP (4357)

The Australian Consumer Law requires the inclusion of the following statement with this warranty:

Our goods come with guarantees that cannot be excluded under the Australian Consumer Law. You are entitled to a replacement or refund for a major failure and for compensation for any other reasonably foreseeable loss or damage. You are also entitled to have the goods repaired or replaced if the goods fail to be of acceptable quality and the failure does not amount to a major failure.

**This page
is intentionally
left blank**

**This page
is intentionally
left blank**

**An initiative by
Residentia Group**



ESSENTIALS FOR LIFE

**T. 1300 11 4357
E. support@residentiagroup.com.au**

www.solt.house



E2447

SÔLT