

**EN** Instruction manual

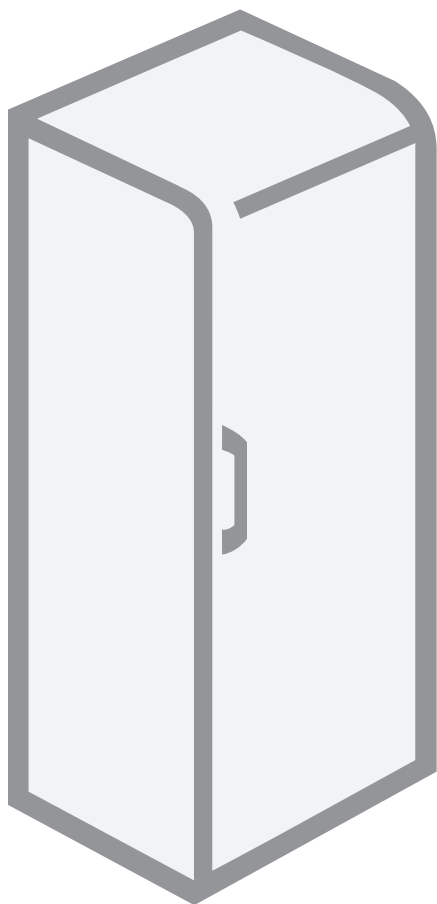

Refrigerator

We thank you for the confidence you have shown by purchasing our appliance.  
We wish you find a lot of pleasure in its use.

**The appliance is intended solely for household use.**

**The refrigerator** is intended for storing fresh food at temperatures above 0°C.

<b>Important notes and warnings .....</b>	<b>3</b>
<b>Advice for saving power with refrigeration appliances .....</b>	<b>5</b>
<b>Appliance description .....</b>	<b>6</b>
<b>Installation and connection .....</b>	<b>7</b>
<b>Changing the direction of door opening .....</b>	<b>9</b>
<b>Operating the appliance with mechanic controls...</b>	<b>13</b>
<b>Operating the appliance with electronic controls ..</b>	<b>14</b>
<b>Appliance interior equipment.....</b>	<b>19</b>
<b>Recommended distribution of food in the appliance .....</b>	<b>23</b>
<b>Storing food in the refrigerator .....</b>	<b>24</b>
<b>Storing food in the FreshZone drawer .....</b>	<b>25</b>
<b>Defrosting the appliance.....</b>	<b>26</b>
<b>Cleaning the appliance .....</b>	<b>26</b>
<b>Troubleshooting .....</b>	<b>27</b>
<b>Information about appliance noise .....</b>	<b>28</b>

## Important notes and warnings

- This appliance can be used by children aged from 8 years and above and persons with reduced physical, sensory or mental capabilities or lack of experience and knowledge if they have been given supervision and instruction concerning use of the appliance in a safe way and understand the hazards involved.

Children shall not play with the appliance.

Cleaning and user maintenance shall not be made by children without supervision.

- Before connecting the appliance to the power mains, please read carefully the instructions for use which describe the appliance and its correct and safe use. The instructions apply for several appliance types/models; thus, settings or equipment may be described herein which is not available in your appliance.
- Remove the packaging intended for protecting the appliance or particular parts during transport.
- Spacers are fitted on the corners of the doors. Remove them and insert the supplied plugs into their slots (only in some models).
- Before connecting the appliance to the power mains, let the appliance rest in a vertical position for approximately 2 hours. This will reduce the possibility of operation faults due to the effect of transport on the cooling system.
- The appliance must be connected to the power mains and grounded in compliance with the effective standards and regulations.
- The appliance may not be used outdoors and it may not be exposed to rain.
- Before cleaning the appliance, unplug the appliance from the power mains (unplug the power cord from the wall outlet).
- If the power cord is damaged, it must be replaced by a service technician or other adequately trained person.
- If the appliance will be out of use for a prolonged period of time, switch it off using the relevant button, and unplug the appliance from the power mains. Empty the appliance, defrost it, clean it, and leave the door ajar.



- If LED lighting does not work, call a service technician. Do not attempt a repair of the LED lighting yourself, as there is danger of contact with high voltage!
- To protect the environment, take the obsolete appliance to an authorized home appliance collection center.
- Packaging is made of environmentally friendly materials that can be recycled, disposed of, or destroyed without any hazard to the environment.
- Do not let the children play with the appliance.
- Cleaning and user maintenance shall not be made by children without supervision.
- Rating plate can be found in the appliance interior. If the language on the rating plate is not the language of your choice or the language of your country, replace it with the one supplied.
- **WARNING!** Ventilation openings on the appliance or built-in cupboard must be kept clean and unobstructed at all times.
- **WARNING!** Do not use any mechanical accessories or other methods to defrost the appliance, except for those expressly recommended by the manufacturer.
- **WARNING!** During installation, cleaning, and removal of appliance, be careful not to damage the insulation of the parts of the cooling system. This will also prevent pollution.
- **WARNING!** Do not use any electric devices inside the appliance, except for those allowed by the manufacturer of this refrigeration appliance.



The symbol on the product or its packaging indicates that the product should not be treated as normal household waste. The product should be taken to an authorized collection center for waste electric and electronic equipment processing. Correct disposal of the product will help prevent any negative effects on the environment and health of people which could occur in case of incorrect product removal. For detailed information on removal and processing of the product, please contact the relevant municipal body in charge of waste management, your waste disposal service, or the store where you bought the product.

# Advice for saving power with refrigeration appliances

- Install the appliance as specified in the instruction manual.
- Do not open the door more often than necessary.
- Occasionally make sure air circulation underneath the appliance is unobstructed.
- Condenser unit on the rear wall should be kept clean (see chapter Cleaning the appliance).
- If the gasket is damaged or does not provide a perfect seal for other reasons, have it replaced as soon as possible.
- Store the food in tightly sealed containers or appropriate packaging.
- Before placing the food in the appliance, cool it to room temperature.
- Defrost frozen food in the refrigerator compartment.
- Remove the drawers from the freezer compartment as described in the instruction manual, in order to make use of the entire interior.
- Defrost your conventional freezer when an approximately 3-5 millimeter layer of frost or ice has built up on the refrigerated surfaces.
- Make sure the layout of shelves in the compartment is uniform and that the food is placed so that the air can freely circulate in the appliance interior (observe the recommended placement of food as described in the instructions).
- In appliances with a fan, do not block the fan slots.
- If you do not need the fan or the ionizer, switch them off to reduce power consumption.

# Appliance description

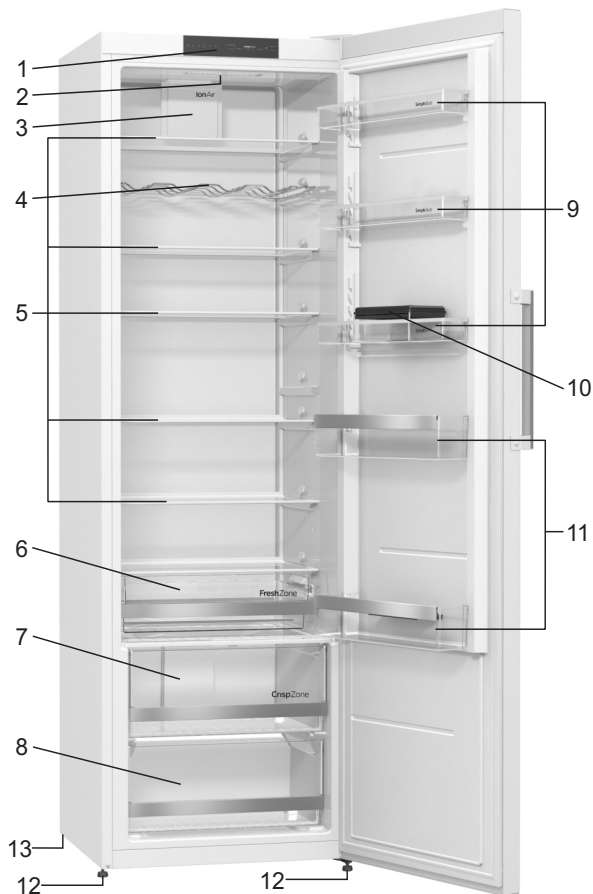

- 1 Control unit
- 2 Led lighting of refrigerator interior
- 3 Fan with air ionizer (+ on/off switch)\*
- 4 Bottle rack\*
- 5 Pull-out glass shelf (height adjustable)
- 6 FreshZone drawer\*
- 7 CrispZone fruit and vegetables drawer with humidity control
- 8 Fruit and vegetables drawer
- 9 SimpleSlide height-adjustable door bin
- 10 Multibox storage bin\*
- 11 Bottle bin
- 12 Foot
- 13 Caster\*

- Appliance interior equipment may change according to the appliance model.
- The drawers are protected against pulling out. To remove a drawer from the appliance, open it, then lift the front part and pull it out.
- Some models also feature a control unit on the door.

\* Only in some models

# Installation and connection

## Selecting the room

- Install the appliance in a dry and well ventilated room. The appliance will operate correctly if the environment temperature is in the interval specified in the table. The appliance class is indicated on the rating plate / label with the basic information on the appliance.

Class	Temperature
SN (subnormal)	from +10°C to +32°C
N (normal)	from +16°C to +32°C
ST (subtropical)	from +16°C to +38°C
T (tropical)	from +16°C to +43°C

**Warning:** Make sure the room where the appliance is installed is large enough. There should be at least 1 m<sup>3</sup> of space per 8 grams of refrigerant. Amount of refrigerant is stated on the rating plate in the appliance interior.

## Installing the appliance

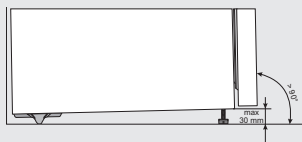

Appliance installation should be carried out by at least two persons to avoid any physical injury or damage to the appliance.

- The appliance must stand level or tilted slightly to the back, stable on a solid base. At the front, the appliance is fitted with two adjustable legs that can be used to level the appliance. At the rear side, casters allow for easier installation of the appliance (only with some models).
- There should be a clearance of at least 5 cm between the appliance and any cupboard installed above it, in order to allow adequate cooling of the condenser unit.
- The appliance is supplied with two spacers which should be installed on the lower part of the housing to prevent from pushing the appliance too close to the wall. Appliance may also be installed without the spacers; however, this may increase power consumption.
- Do not expose the appliance to direct sunlight and do not place it near any source of heat. If this cannot be avoided, install an insulation panel.



- The appliance may stand alone or it may be placed ext to a cupboard or a wall. Consider the clearance required to fully open the door in order to allow pulling out the drawers and shelves (see installation diagram).

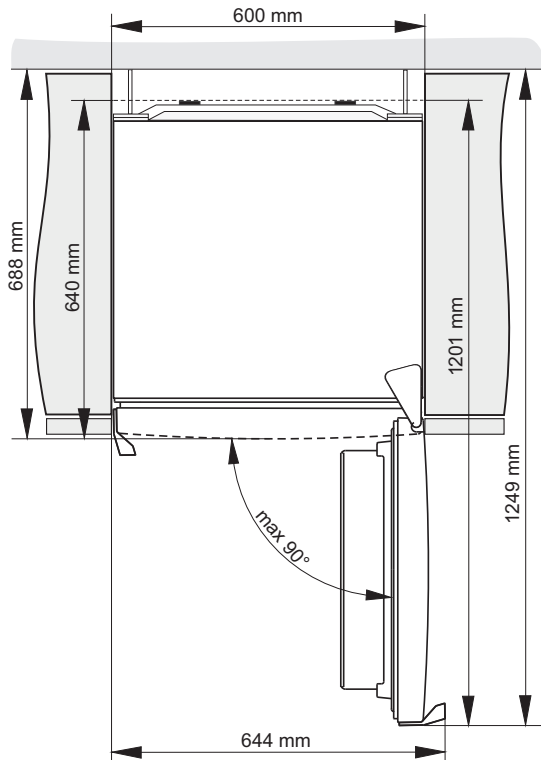

**Note:** When placing the appliances side by side, the anti-dew (anti-condensation) set has to be purchased and installed!

Code for ordering the set:

- appliances with a height of 1850 mm: 576604.

## Connecting the appliance

- Connect the appliance to the power mains using a connection cable. The wall outlet should be fitted with a ground contact (safety socket). Nominal voltage and frequency are indicated on the rating plate/label with basic information on the appliance.
- The appliance must be connected to the power mains and grounded in compliance with the effective standards and regulations. The appliance will withstand short-term deviations from the nominal voltage, but not more than +/- 6%.

# Changing the direction of door opening

## Version I – controls in the appliance interior

**Tools required: socket wrench No. 8, Phillips screwdriver, torx 25, flat screwdriver**

**The procedure to change the direction of door opening should be carried out by at least two persons.**

1. Remove the upper hinge cover (A) and the covering cap (G).
2. Undo the upper hinge (B) and remove the door (C) from the lower hinge (D).
3. Tilt the appliance backwards (make sure you do not press against the condenser unit on the rear wall of the appliance as this may damage the cooling system), unscrew the lower hinge (D) and the foot (E), and move them to the opposite side. Make sure the washer is installed like it was before disassembly.
4. Move the door hinges (F) to the opposite side and replace the door (C) back on the lower hinge (D).
5. Use the screws to attach the upper hinge (B) on the opposite side.
6. Replace the upper hinge cover (A) and the covering cap (G) on the opposite side.
7. Replacing the handle (H): remove the handle covering caps, undo the screws, and remove the handle. Remove the hole plugs on the opposite side of the door and attach the handle. Replace the covering caps on the handle. Insert the new hole plugs supplied in the bag with the instruction manual into the holes where the handle was initially attached.

### Replacing the hinged handle:

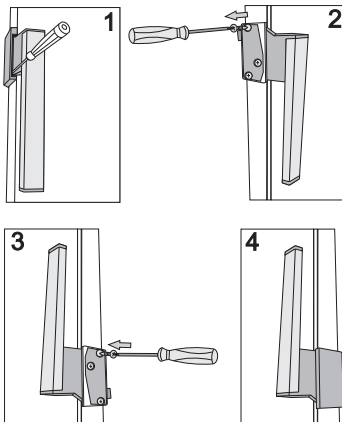

- Push a small screwdriver into the handle slot as indicated in Figure 1 and remove the cover.
- Remove the caps on the opposite side of the door.
- Undo the three screws, making sure not to disassemble the handle.
- Rotate the handle by 180° as indicated in Figure 3 and attach it to the opposite side of the door.
- Replace the cover and the caps.

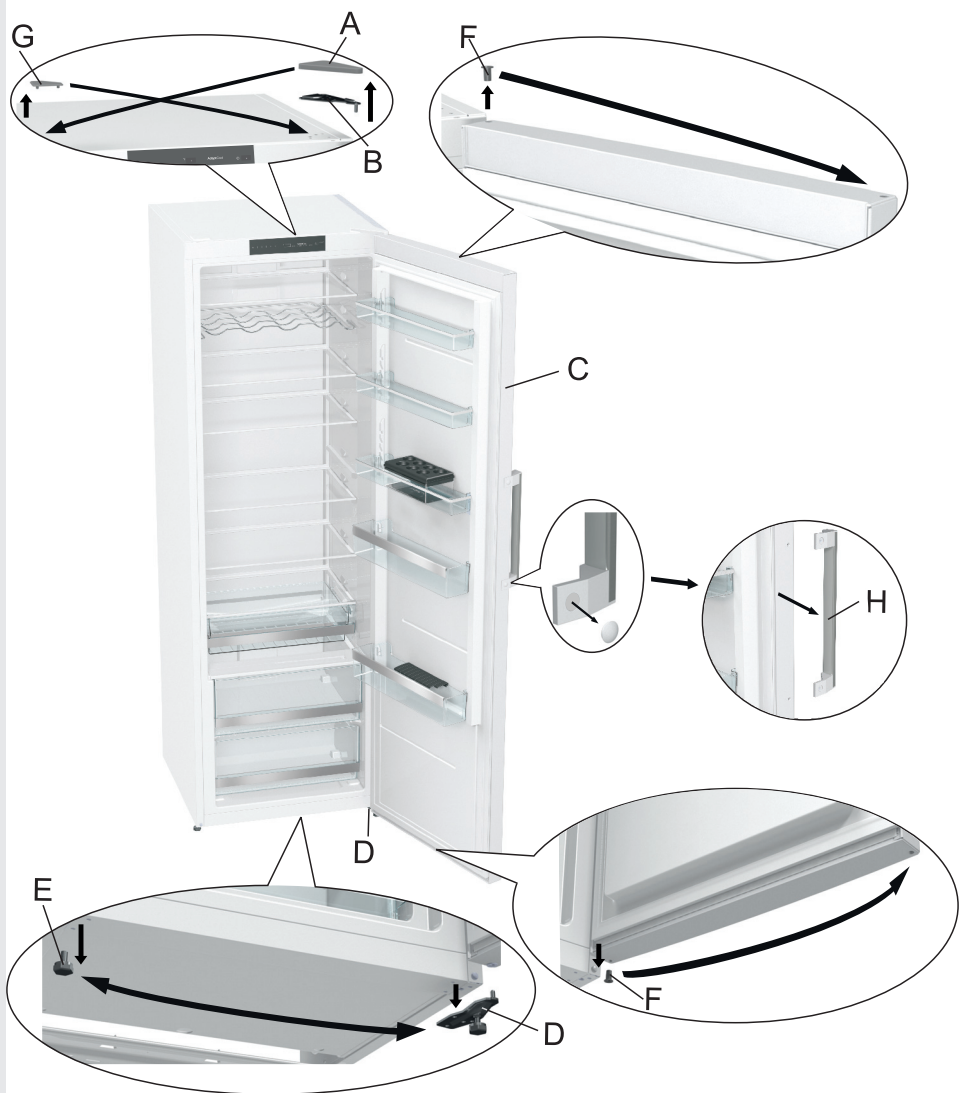

## ***Version II – Controls on the door***

**Tools required: socket wrench No. 8, Phillips screwdriver, torx 25, flat screwdriver**

**The procedure to change the direction of door opening should be carried out by at least two persons.**

1. Remove the upper hinge cover (A), the connector cover (B1) and the covering cap (M).
2. Disconnect the connector (C), undo the upper hinge (D) and remove the door (E) from the lower hinge (I).
3. Remove the side panels (F) and (G), then unscrew and remove the middle panel (H).
4. Move the upper hinge (D) along with the connector and cable to the opposite side – make sure to install the cable into the grooves in the panels like it was before disassembly. Then, replace all three panels (F), (G), and (H).
5. Tilt the appliance backwards (make sure you do not press against the condenser unit on the rear wall of the appliance as this may damage the cooling system), unscrew the lower hinge (I) and the foot (J), and move them to the opposite side. Make sure the washer is installed like it was before disassembly.
6. Move the cap (B2), door hinge (K) and retainer (L) to the opposite side and replace the door (E) on the lower hinge (I).
7. Use the screws to attach the upper hinge (D) on the opposite side and reconnect the connector (C).
8. Replace the upper hinge cover (A), the connector cover (B1) and the covering cap (M).
9. Replacing the handle (N): remove the handle covering caps, undo the screws, and remove the handle. Remove the hole plugs on the opposite side of the door and attach the handle. Replace the covering caps on the handle. Insert the new hole plugs supplied in the bag with the instruction manual into the holes where the handle was initially attached.

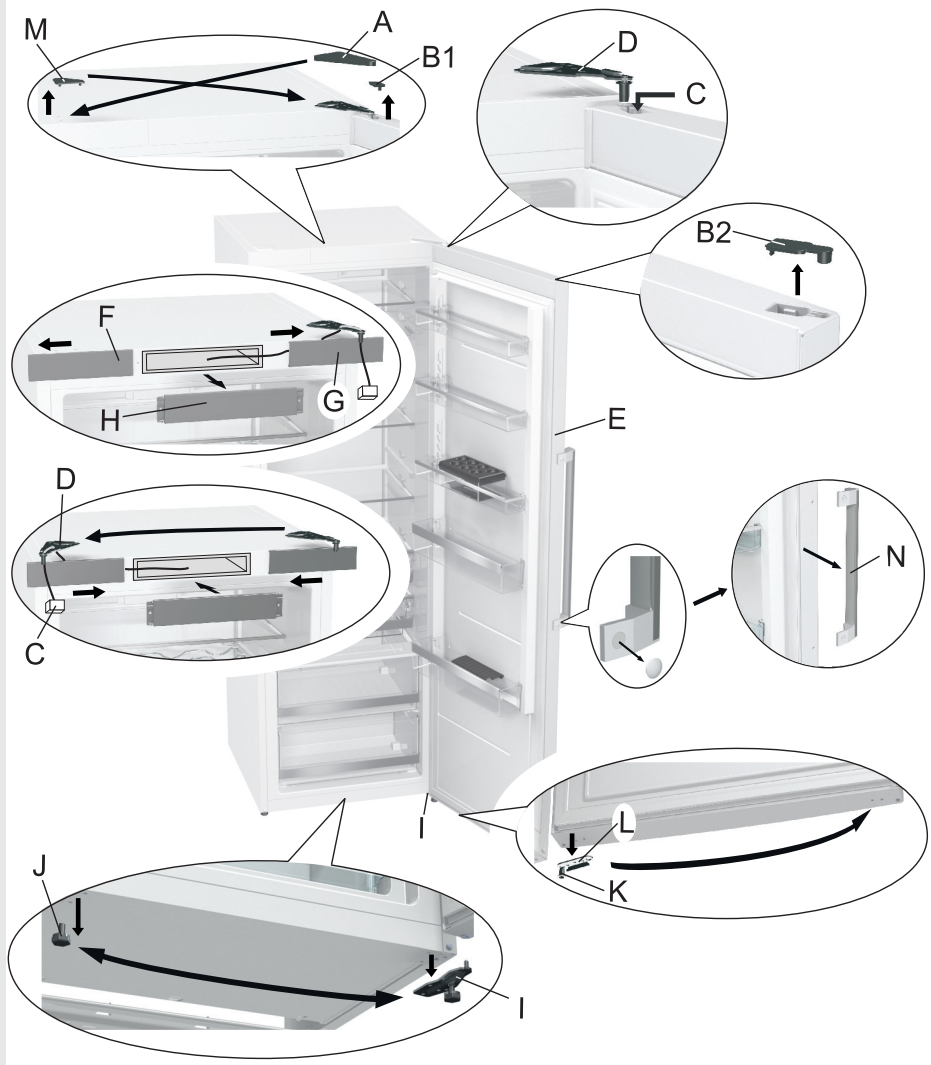

# Operating the appliance with mechanic controls

## CONTROL UNIT 1

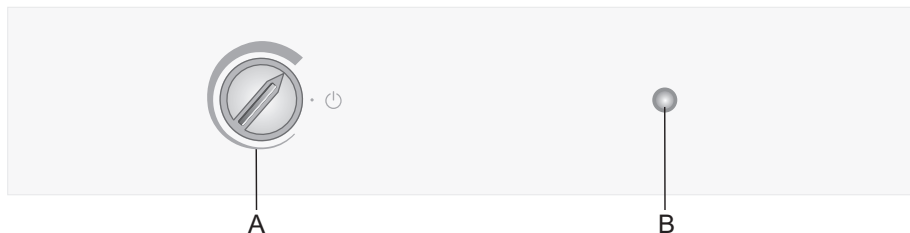

A Temperature setting and on/off knob

B Lighting on/off key

### Switching the appliance on/off

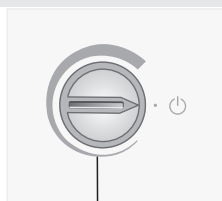

A

To switch on: rotate the **A** dial clockwise.

**Switching off:** Rotate the **A** knob back to the position in which the arrow is aligned with the symbol  (caution: appliance will remain powered, i.e. there will still be electric current in the appliance).

### Adjusting the temperature

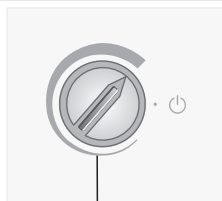

A

- To set the desired temperature, rotate the **A** dial in clockwise direction, i.e. to the right.
- A change in the environment temperature will affect the temperature in the appliance. Adjust the setting with the **A** dial accordingly. Positions towards the **thicker part** of the sign mean a lower temperature in the appliance (cooler). Settings towards the **thinner part of the sign** mean a higher temperature (warmer).

# Operating the appliance with electronic controls

## CONTROL UNIT 2

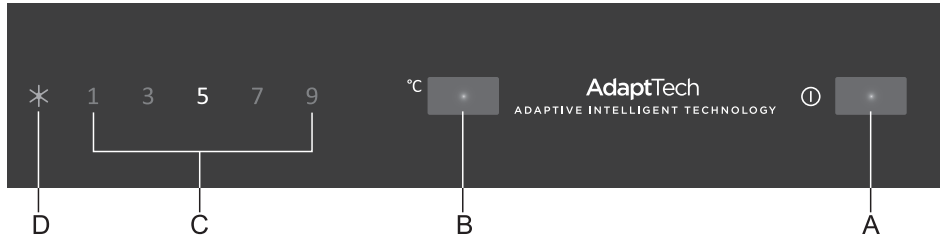

- A On/off switch
- B Temperature adjustment and cooling boost key
- C Refrigerator temperature display
- D Cooling boost function display

### Switching the appliance on/off

The appliance can be switched on and off with the on/off key **A**.

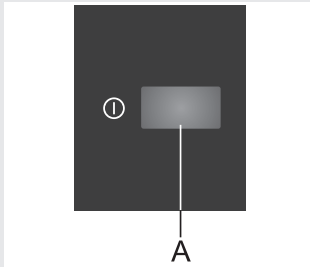

### Adjusting the temperature in the appliance

- Adjust the temperature as desired with the **B** key.
- When the **B** key is pressed for the first time, the most recently set temperature will be displayed on the display unit **C**. Key pressing the **B** key until the desired temperature is displayed on the display unit **C**. Three seconds after the last press of the key, the selected temperature is automatically saved as the most recently selected temperature.

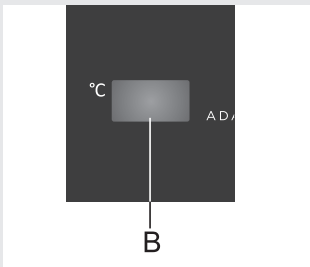

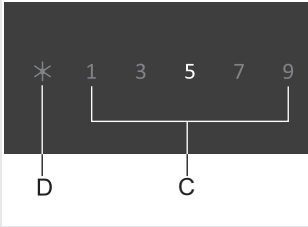

- Recommended setting is 5°C.

### Refrigerator boost

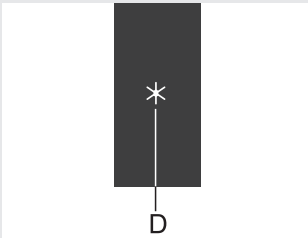

- Use this setting after switching on the appliance for the first time, before cleaning, or before inserting a large amount of food.

To activate the cooling boost function, press the **B** key until the symbol **D** lights up.

If the function is not deactivated manually, it will be deactivated automatically after approximately six hours. Refrigerator compartment temperature will return to the most recent setting. Cooling boost function can also be switched off before it is automatically deactivated by setting a temperature for the refrigerator compartment.

## CONTROL UNIT 3

### Controls on the door

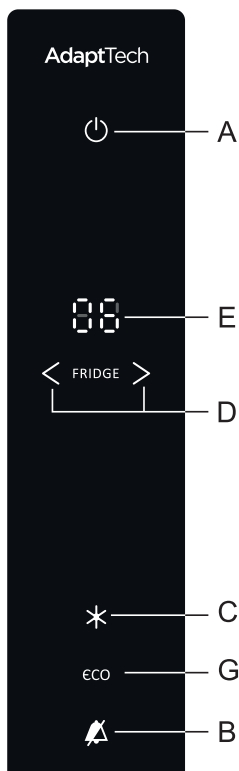

- A On/off key
- B Acoustic alarm off key
- C Cooling boost on/off key
- D Refrigerator temperature keys
- C Refrigerator temperature display
- G ECO function on/off key

## Switching the appliance on/off

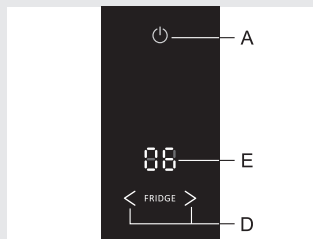

**Switching the appliance on:** Switch on the appliance by briefly pressing the **A** key.

**Switching off the appliance:** To switch off the appliance, press the **A** key and hold it for 3 seconds.

## Adjusting the temperature in the appliance

- Use the **D** keys to set the temperature.
  - < lower temperature ; > higher temperature.
- Refrigerator compartment temperature can be set in the range from +1°C to 9°C.
- After one of the **D** keys is pressed, the most recent temperature setting will flash on the display unit **E**. Use the **D** keys to set the desired temperature. Three seconds after the last key is pressed, the most recent temperature setting is automatically stored for the refrigerator compartment.

## Cooling boost

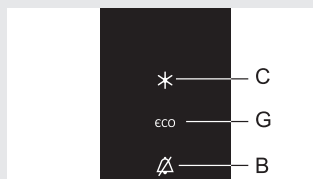

- Use this setting after switching on the appliance for the first time, before cleaning, or before inserting a large amount of food.

To activate the cooling boost, press the **C** key.

If the function is not deactivated manually, it will be deactivated automatically after approximately six hours.

Refrigerator compartment temperature will return to the most recent setting.

Cooling boost function can also be switched off before it is automatically deactivated by setting a temperature for the refrigerator compartment.

## High temperature alarm

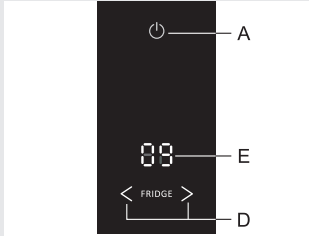

If the temperature inside the appliance is too high, acoustic alarm will be activated (intermittent tone) and the **B** key will flash.

- Acknowledge and turn off the acoustic alarm by pressing the **B** key.
- The acoustic alarm will be activated every 24 hours if the temperature in the appliance is not low enough and there is danger of food spoilage. The alarm will be switched off automatically as soon as the temperature in the refrigerator drops to a level that no longer presents spoilage hazard.
- When the appliance is switched on for the first time, there is a 24-hour delay in temperature alarm operation as it takes some time for appliance to reach the adequate temperature. Thus, unnecessary activation of alarm is prevented.
- If the temperature in the appliance is too high due to a power supply failure, »9°C« will flash on the display unit.

**Open door alarm:** if the door is open for more than 2 minutes, acoustic alarm will be activated and the **B** key will flash. When the door is closed, the alarm will be deactivated. It can also be switched off by pressing the **B** key.

## Eco function

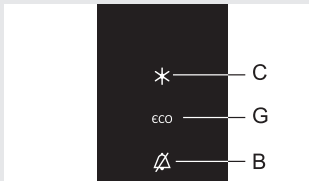

To activate the **Eco** function, press the **G** key. With this function activated, appliance will operate with optimum settings.

## Safety block (child safety lock)

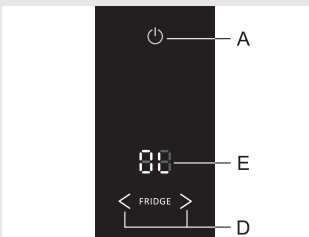

Use this function if you do not wish to manually adjust the appliance settings.

To activate, press and hold the **B** key (for three seconds); L will appear on the display **E**.

This will lock all keys except **B**.

To deactivate the safety lock, press the **B** key and hold it for three seconds.

# Appliance interior equipment

(\* Equipment depends on the model)

## Shelf



- For easier access to food and clarity, the shelves can be partly pulled out.
- The shelves may be adjusted to suit your preferences using the guides in the refrigerator interior. To remove a shelf from the refrigerator, pull it out to the point when it is stopped by the guide. Then, lift it slightly at the front part and pull it all the way out.

Store perishables at the back of the shelf where the temperature is the lowest.

## Wire bottle rack\*



- Some models also feature a wire bottle holder. The bottle holder is protected against being inadvertently pulled out. It can only be pulled out when it is empty. To pull it out, lift it slightly at the back and pull it towards you. Place the bottle holder so that the length of the bottles does not prevent proper closing of the door. The holder can take a maximum load of 9 0.75-liter bottles or 13 kilograms of total weight – see label on the right side in the appliance interior.
- Cans may also be placed on the bottle rack (lengthwise or crosswise).

## Elastic bottle mat\*

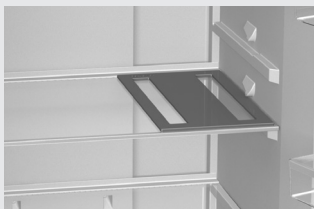

- Some models feature an elastic mat on which bottles or cans can be placed.
- The mat can also be used as a trivet for hot pans.

## CrispZone – fruit and vegetable bin with humidity control

- The bin at the bottom of the refrigerator is intended for storing fruit and vegetables. It provides humidity and prevents the food from drying out.
- Store the food in suitable packaging to prevent them from emitting or taking on odours. The bin has integrated humidity regulator which allows setting the humidity according to the amount of food stored.



**Smaller amounts of food** - push the control slider to the right;  
**Larger amounts of food** - push the control slider to the left;

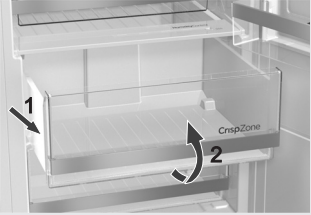

- Removing the fruit and vegetable bin:
  - Pull out the bin as far as it will go. Then, lift the front part and pull it out completely.

### **Interior side of the refrigerator door**

Mounted on the refrigerator door are compartments (shelves or bins) intended for storing cheese, butter, eggs, yoghurt and other smaller packages, tubes, cans, etc. There is a bottle shelf at the lower end of the door.

### **Adjustable door bins**

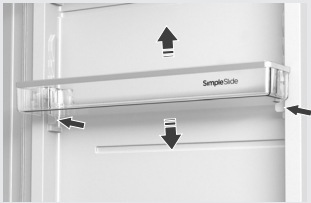

The height of the door bins can be adjusted without having to remove the bins from the appliance. Simply pull the two levers on each side of the bin towards you and slide the bin up or down.

To remove a bin from the appliance, lift it as far as it will go and pull it out.

### **Storage bin (MultiBox)\***



- **MultiBox** bin offers a convenient way for storing food with a strong or pungent smell, e.g. ripened or blue-vein cheese, sausages, onions, butter etc.
- The silicone lid provides an air-tight seal that prevents the food from drying out and the odour to spread throughout the refrigerator compartment.
- The silicon lid can also be used as an egg or ice tray.
- If the flexible lid is used as an egg tray, place it directly on the bottom of the door bin and use the open lower part of the MultiBox bin to store food in smaller packages – pâté, jams, smaller tubes etc.

## Fan\*

- The fan placed under the refrigerator compartment ceiling or hidden in the freezer unit will make sure the temperature is distributed more evenly and reduce condensation (dew) on the storage surfaces.

## Ionizer (IonAir)\*

- **Air ionizer** placed in the refrigerator compartment removes most bacteria, viruses, gases, and unpleasant odours to make sure the air in the refrigerator is always fresh. The food will remain fresh and tasty longer.
- Air ionizer can be switched on and off using the switch located on the fan housing or on the side of the cooling tower (depending on the model).

Control unit 1

### Switching the fan and ionizer on and off

ON =  OFF = 0

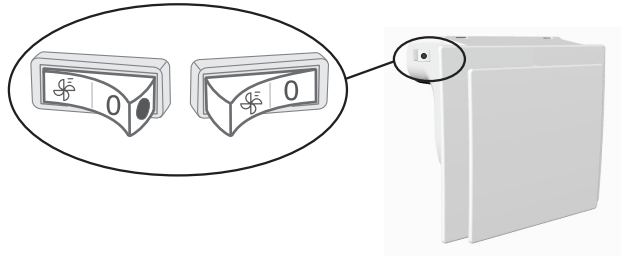

*When the fan and the ionizer are switched on, a red dot will be visible on the switch.*

### Switching the ionizer on/off

ON = I                      OFF = 0

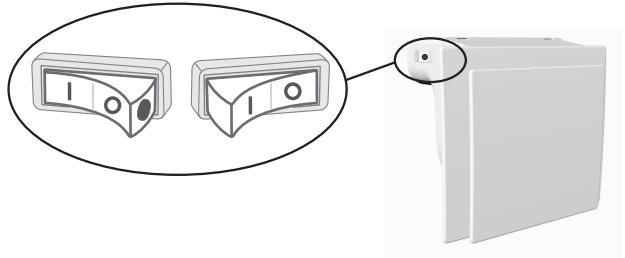

*When the ionizer is switched on, a red dot will be visible on the switch.*

### **Adaptive Intelligent Technology**

(only with control units 2 and 3)

Innovative sensor technology allows adjusting appliance operation to the user's habits or behaviour. Adaptive intelligent system monitors, analyzes, and records on weekly basis the use of appliance and adapts appliance operation to the perceived patterns. If the appliance is able to anticipate increased frequency of door opening, the appliance will automatically lower the temperature before such time to reduce heating of the food as the door is opened more often.

# Recommended distribution of food in the appliance

## **Recommended distribution of food in the appliance**

### **Sections of the refrigerator:**

- **upper part:** canned food, bread, wine, pastry etc.
- **middle part:** dairy products, ready-made meals, desserts, soft drinks, beer, cooked food, etc.
- **Fresh bin:** - meat, meat produce, delicatessen;
- **Fruit and vegetable bin:** fresh fruit, vegetables, salads, root vegetables, potatoes, onions, garlic, tomatoes, tropical fruit, sauerkraut, turnips etc.





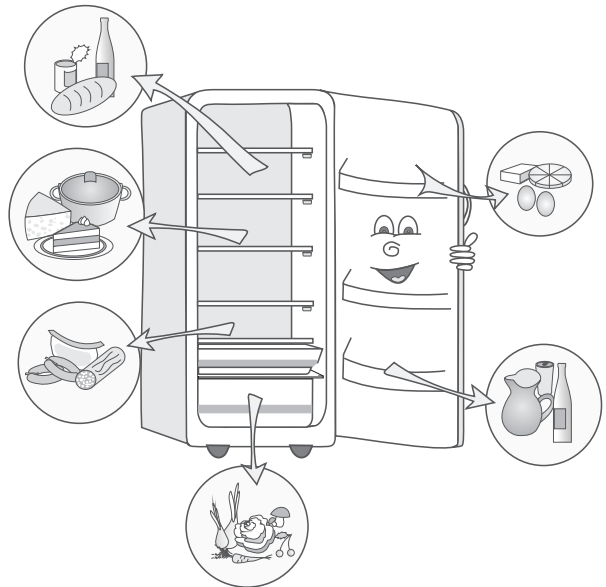



### **Sections in the refrigerator compartment door:**

- **upper/middle door bins:** eggs, butter, cheese etc.
- **lower door bins:** beverages, cans, bottles etc.



# Storing food in the refrigerator

## Important warnings regarding food storage

-  **Correct use of the appliance, appropriate packaging, maintaining the right temperature, and observing the food hygiene standards has a decisive impact on the quality of food storage.**
-  **Observe the expiry dates for the food, specified on the packaging.**
-  **Food stored in the refrigerator should be kept in closed containers or appropriate packaging to prevent them from emitting or receiving odours.**
-  **Do not store inflammable, volatile, and explosive substances in the refrigerator.**
-  **Bottles with high alcohol content should be tightly sealed and stored in an upright position.**
-  **Some organic solutions, essential oils in lemon and orange peel, butter acid, etc. may damage the plastic surfaces in case of a prolonged contact, causing damage and premature ageing of these materials.**
-  **Unpleasant odour warns of lacking cleanliness of the appliance or perished contents (see *Cleaning the Appliance*).**
-  **If you are leaving home for a longer period of time, remove perishables from the refrigerator.**

## Food storage times

### Recommended storage time in the refrigerator

Type of food	Time
eggs, marinades, smoked meat	up to 10 days
cheese	up to 10 days
root vegetables	up to 8 days
butter	up to 7 days
deserts, fruit, ready-to-eat food, chunks of raw meat	up to 2 days
fish, raw minced meat, seafood	up to 1 day

## Storing food in the FreshZone drawer

In the **FreshZone** compartment, food stays fresh longer than in a conventional refrigerator, retaining more flavour and nutrients. Decay and loss of mass are slowed down; therefore, fruit and vegetables remain fresh and natural longer.

For optimum performance, the drawer should be fully closed.

- When buying food, make sure it is fresh as this will determine the quality of the food, as well as how long it will keep in the fridge.
- Store the food in closed containers or appropriate packaging to prevent them from emitting or receiving odours.
- Take the food from the drawer 30-60 minutes before use to allow the aroma and flavour develop at room temperature.
- Food sensitive to low temperature and not appropriate for storage in the **FreshZone** drawer include the following: pineapple, avocado, bananas, olives, potatoes, eggplant, cucumbers, beans, peppers (capsicum), melons, watermelons, pumpkins, squash, zucchini etc.
- To remove the drawer:
  - Pull out the drawer until it is blocked.
  - Then, lift it at the front and pull it all the way out.

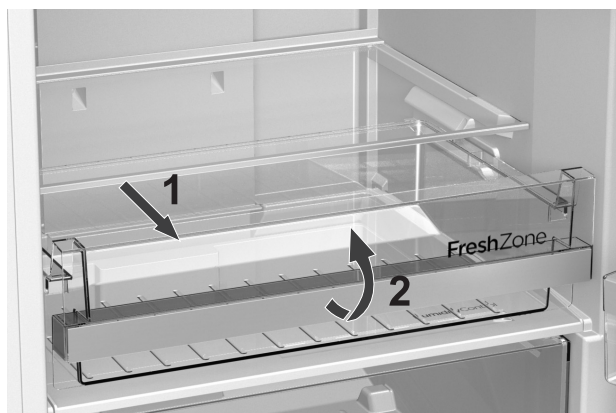

## Defrosting the appliance

### Automatic refrigerator defrosting

Refrigerator does not need defrosting because the ice on the back interior wall is thawed automatically. Any accumulated ice will melt when the compressor unit is inactive. Drops will flow through an opening in the refrigerator rear wall into a tray fitted above the compressor, from where they will evaporate.

If an excessive layer of ice is formed on the rear wall of refrigerator interior (3-5 mm), switch off the appliance and defrost the appliance manually.

## Cleaning the appliance

### Before cleaning, unplug the appliance from the power mains

– switch off the appliance (see chapter Switching the Appliance On/Off) and unplug the power cord from the wall outlet.

- Use a **soft cloth** to clean all surfaces. Cleaners that contain **abrasive substances, acids, or solvents are not suitable for cleaning** as they may damage the surface.

Clean the appliance **exterior** with water or a mild solution of suds. Lacquer-coated and aluminium surfaces may be cleaned with lukewarm water to which you have added a mild detergent. Use of cleaners with low alcohol content is allowed (e.g. window cleaners). Do not use cleaners containing alcohol for cleaning plastic materials.

**Appliance interior** can be cleaned with lukewarm water to which you can add some **vinegar**.



- A gutter and an opening through which the water from thawed ice flows are located underneath the cooling panel that cools the refrigerator interior. The gutter and the opening may not be clogged. Inspect them often and clean if necessary (e.g. with a plastic straw).
- Frost or ice build-up, 3-5 mm thick, will increase power consumption. Therefore, it should be regularly removed. Do not use any sharp objects, solvents, or sprays.
- The **condenser** unit mounted on the (exterior) back wall should always be kept clean, free of dust or deposits resulting from kitchen smoke or fumes. Occasionally clean the dust using a soft non-metal brush or a vacuum cleaner.

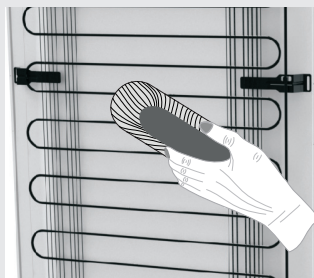

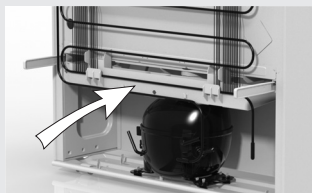

- Also clean the **tray** above the refrigerator compressor. If you remove it, replace it after cleaning. Make sure it is placed horizontally.
- After cleaning, switch the appliance back on and insert the food.

## Troubleshooting

Problem:	Cause or remedy:
Appliance is connected to the power mains but it does not work.	<ul style="list-style-type: none"> <li>• Make sure there is voltage in the power outlet and that the appliance is switched on.</li> </ul>
Cooling system operates continuously for a long period of time:	<ul style="list-style-type: none"> <li>• Too high environment temperature.</li> <li>• Door opened too frequently or too long.</li> <li>• Door not closed correctly (possible impurities on the seal, misaligned door, damaged seal etc.).</li> <li>• Too much fresh food inserted at once.</li> <li>• Sensor in the refrigerator (A) blocked by fresh food. Make sure the air can circulate around the sensor (only with some models).</li> <li>• Insufficient compressor and condenser cooling. Check the air circulation behind the appliance and clean the condenser unit.</li> </ul>
Excessive build-up of ice on the back wall of refrigerator interior can be a result of the following:	<ul style="list-style-type: none"> <li>• Door opened too frequently or too long.</li> <li>• Warm food placed in the refrigerator.</li> <li>• Food in contact with the back interior wall of the refrigerator.</li> </ul>
	<ul style="list-style-type: none"> <li>• Poor door sealing. If the seal is dirty or damaged, clean it or replace it.</li> </ul>
Condensate (dew) on the shelf above the drawers:	<ul style="list-style-type: none"> <li>• This is a transient phenomenon which cannot be entirely avoided in periods of high environment temperature and humidity. It subsides when temperature and humidity are normalized. We recommend cleaning the drawers more frequently and wiping the droplets occasionally.</li> <li>• Open the humidity control slider.</li> <li>• Place the food in to bags or other airtight packaging.</li> </ul>
Water leaking from the refrigerator:	<ul style="list-style-type: none"> <li>• Clogged water discharge opening or water dripping past the water gutter.</li> <li>• Clean the clogged opening, for example using a plastic straw.</li> <li>• If a thick layer of ice builds up, defrost the appliance manually (see Defrosting the Appliance).</li> </ul>
	<ul style="list-style-type: none"> <li>• A longer power failure.</li> </ul>
The <b>B</b> key will flash (applies to control unit 3).	<ul style="list-style-type: none"> <li>• Door opened too frequently or too long.</li> <li>• Door not closed correctly (possible impurities on the seal, misaligned door, damaged seal etc.).</li> <li>• A longer power failure.</li> <li>• Too much fresh food inserted at once.</li> </ul>



Problem:	Cause or remedy:
Door is difficult to open:	<ul style="list-style-type: none"> <li>• If you are trying to open the appliance door after just having closed it, this could be difficult to do. As you open the door, some cool air escapes from the appliance and it is replaced by warm air from the environment. When this air is cooled, negative pressure is generated which results in problems as you try to open the door. After a few minutes, the condition is normalized and the door can be easily opened again.</li> </ul>
LED lighting does not work:	<ul style="list-style-type: none"> <li>• If LED lighting does not work, call a service technician.</li> <li>• Do not attempt a repair of the LED lighting yourself, as there is danger of contact with high voltage!</li> </ul>
Indication of error code on the display (only with some models):	<ul style="list-style-type: none"> <li>• If E appears on the display, call a service technician.</li> </ul>

If none of the instructions above fixes your problem, call the nearest authorized service center and state the type, model, and serial number found on the rating plate/label which is located in the appliance interior.

## Information about appliance noise

Cooling in refrigerator freezers is made possible by a cooling system that also includes a compressor (and a fan with some appliances), which generates some noise. The level of noise depends on installation, proper use, and age of the appliance.

- **After connecting the appliance to the power mains**, compressor operation, or the sound of flowing liquid, may be somewhat louder. This is not a sign of malfunction and it will not affect the useful life of the appliance. In time, appliance operation and this noise will become quieter.
- Sometimes, **unusual or loud noise** may appear during appliance operation; these are mostly the result of improper installation:
  - The appliance must stand level and stable on a solid base.
  - The appliance may not be in contact with a wall or adjacent furniture.
  - Make sure the interior equipment sits firmly in its place and that the noise is not caused by cans, bottles or other containers placed next to each other.
- Due to the higher workload on the cooling system when the door is opened more frequently or for a longer time, when a large amount of fresh food is introduced, or when intensive freezing or cooling functions are activated, the appliance can temporarily generate more noise.

WE RESERVE THE RIGHT TO MAKE CHANGES THAT  
DO NOT AFFECT THE FUNCTIONALITY OF THE  
APPLIANCE.

Instructions for use of the appliance can also be found on our website at [www.gorenje.com](http://www.gorenje.com) / < <http://www.gorenje.com> / >

