

**Patriot**  
LIGHTING

SKU Number: 351-9160

351-8341

3LT Semi-Flush Mount

Model Number: ISF689A03GPH-M

ISF719A03CH







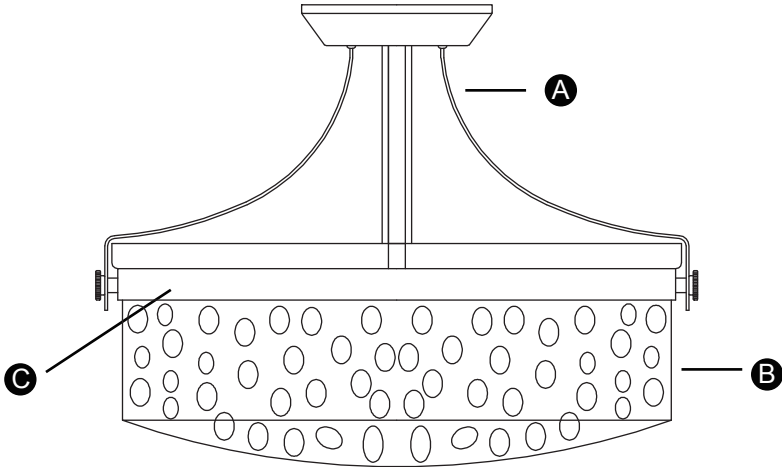

**Questions, problems, missing parts?**

Before returning to your retailer, call our customer service at 1-800-267-4427 Monday – Friday 8:00 a.m. – 5:00 p.m. EST

**PACKAGE CONTENTS**



**HARDWARE CONTENTS Note: Hardware not shown actual size.**

<b>AA</b>		Wire Nut x 3	<b>DD</b>		Star Washer x 2
<b>BB</b>		Mounting Bracket x 1	<b>EE</b>		Cap Nut x 2
<b>CC</b>		Electrical Box Screw x 2	<b>FF</b>		Nut x 3



## IMPORTANT SAFETY INSTRUCTIONS

Please read and understand this entire manual before attempting to assemble, operate or install the product.

Please save this instruction manual.

### WARNING

- Turn off electricity at main fuse box (or circuit breaker box) before beginning installation by removing fuse (or switching off circuit breaker).
- Be careful not to damage or cut the wire insulation (covering) during fixture installation. Do not permit wires to contact any surface having a sharp edge. To do so may damage or cut the wire insulation, which could cause serious injury or death from electric shock.
- This product must be installed in accordance with the applicable installation code by a person familiar with the construction and operation of the product and the hazards involved.
- Connect the ground wires (bare copper or green) from your fixture to the ground wire (bare copper or green) or ground screw in the electrical box.

### CAUTION

- All electrical connections must be in agreement with local codes, ordinances or the national electric code (NEC). Contact your municipal building department to learn about your local codes, permits and/or inspections.
- Risk of fire – most dwellings built before 1985 have supply wire rated for 140°F/60°C. Consult a qualified electrician before installation.
- Do not connect this fixture to an electrical system that does not provide a means for equipment grounding. Never use a fixture in a two-wire system that is not grounded. If you are not sure your lighting system has a grounding means, do not attempt to install this fixture. Contact a qualified, licensed electrician for information with regards to proper grounding methods as required by the local electrical code in your area.
- If a dimmer control switch is used with this fixture, obtain professional advice to determine the correct type and electrical rating required.

## PREPARATION

Before beginning assembly, installation or operation of product, make sure all parts are present. Compare parts with package contents list and diagram on previous page. If any part is missing or damaged, do not attempt to assemble, install or operate the product. Contact customer service for replacement parts.

Tools Required for Assembly (not included): Screwdriver, Phillips Screwdriver, Pliers, Electrical Tape, Wire Cutters, Safety Glasses, Ladder, Wire Stripper

# ASSEMBLY INSTRUCTIONS

1. Spread the arms evenly.

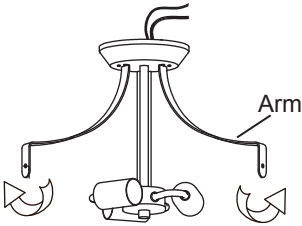

2. Position the glass (B) into the ring (C).

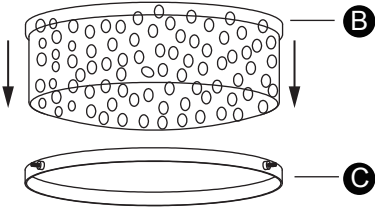

3. Secure the glass (B) in place with the nuts (FF).

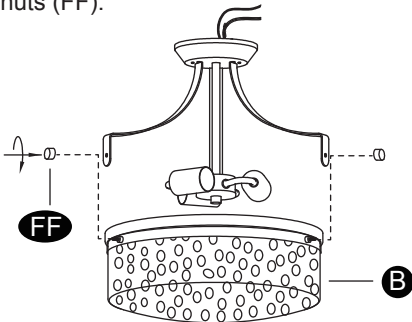

4. Loosen the hex nuts. Adjust studs to desired length and lock in place with hex nuts.

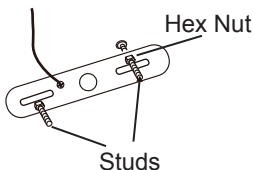

5. Mount the mounting bracket (BB) to electrical box using electrical box screws (CC). Make sure the studs on the mounting bracket (BB) are facing out from the electrical box.

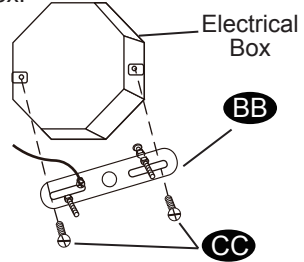

6. Connect the ground wires (bare copper or green) from your fixture to the ground wire (bare copper or green) or ground screw in the electrical box. Connect black wires from fixture to black wire in electrical box and connect the white wires from fixture to white wire in electrical box.

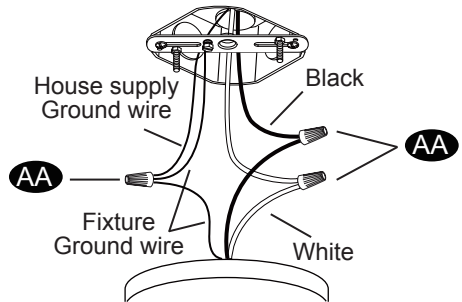

7. Once connections of wires are completed, carefully tuck wires and wire nuts (AA) into the electrical box making sure no bare wire (on the black and white) is visible at the wire nuts (AA).

8. Position fixture over studs on mounting bracket (BB) assembly. Secure fixture (A) in place with star washers (DD) and cap nuts (EE).

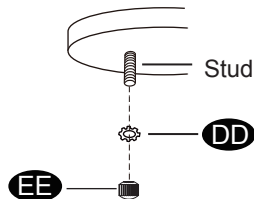

9. Install proper bulb type and wattage (not included).

## CARE AND MAINTENANCE

- To clean, turn off and wipe with a damp, non-abrasive cloth.
- When cleaning, use only a soft brush or lint free cloth to avoid scratching the finish.
- Abrasive cleaning agents are not required and should be avoided to prevent damage to finish.

## TROUBLESHOOTING

- 1) The light does not come on at all:
  - a) Make sure the wall switch and circuit breaker are on.
  - b) Make sure the wiring is correct.
- 2) Fuse blows or circuit trips when light is turned on.
  - a) Check for crossed wires, ensure wiring is correct.

If unable to fix any of the above issues, please consult a certified electrician.

**5-YEAR LIMITED WARRANTY:** If, during normal use, this **PATRIOT LIGHTING®** light fixture fails due to a defect in material and workmanship within five (5) years from the date of purchase, simply bring this light fixture with your original sales receipt back to your nearest **MENARDS®** retail store. At its discretion, **PATRIOT LIGHTING®** agrees to have the lighting fixture replaced with the same or similar **PATRIOT LIGHTING®** product free of charge, within the stated warranty period, when returned by the original purchaser with original sales receipt. This warranty: (1) excludes expendable parts including but not limited to light bulbs; (2) does not cover damage that has resulted from abuse or misuse; and (3) does not cover any losses, labor, injuries to persons/property or costs. This warranty does give you specific legal rights and you may have other rights, which vary from state to state.



### Questions, problems, missing parts?

Before returning to your retailer, call our customer service at 1-800-267-4427 Monday – Friday 8:00 a.m. – 5:00 p.m. EST