

DESÉA

ISTRUZIONI PER L'USO

OPERATING INSTRUCTIONS

MODE D'EMPLOI

BEDIENUNGSANLEITUNG

INSTRUCCIONES DE USO

INSTRUÇÕES DE UTILIZAÇÃO

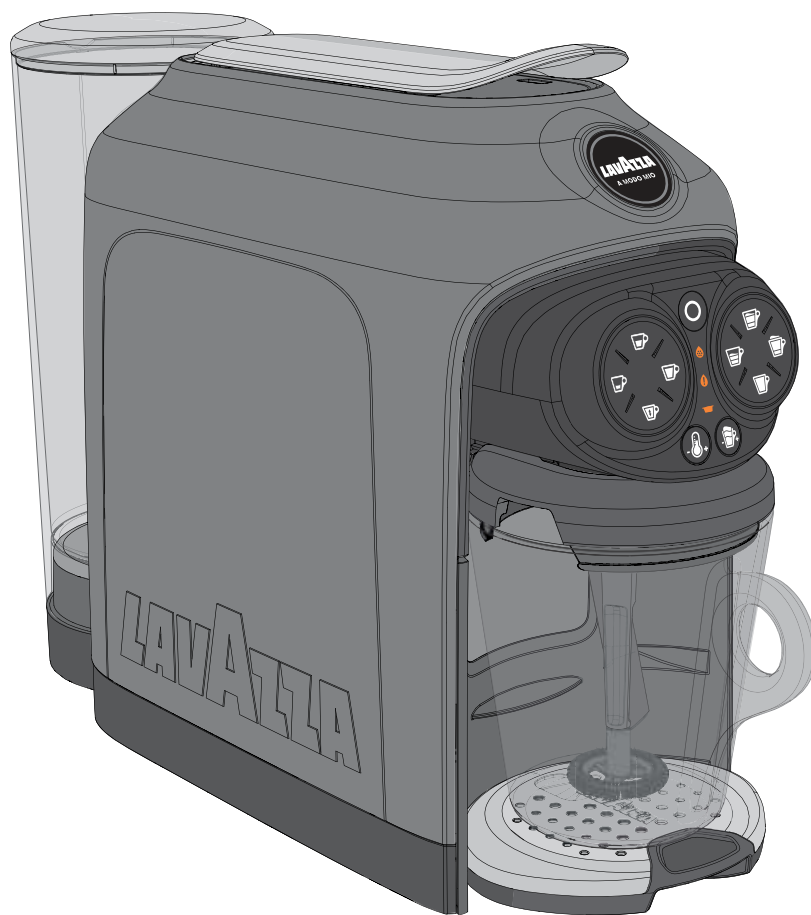

LEGGERE
ATTENTAMENTE
LE ISTRUZIONI

READ THE
INSTRUCTIONS
CAREFULLY

LIRE
ATTENTIVEMENT
LES INSTRUCTIONS

DIE
BEDIENUNGSANLEITUNG
AUFMERKSAM LESEN

LEER ATENTAMENTE
LAS INSTRUCCIONES

LER ATENTAMENTE
AS INSTRUÇÕES

! Intended use:

This appliance is intended to be used in household and similar applications such as:

- staff kitchen areas in shops, offices and other working environments;
- farm houses;
- by clients in hotels, motels and other residential type environments;
- bed and breakfast type environments.

The improper use of the machine may cause possible injuries.

It is prohibited to make any technical changes to the machine.

The machine may not be used by children under 8 years of age or persons with physical, sensory or mental impairment, or lacking the necessary experience, unless supervised or after being instructed in the safe use of the machine and understanding the potential dangers.

Do not let children play with the machine. Keep the machine and its mains lead out of the reach of children under 8 years of age.

The necessary cleaning and maintenance meant to be performed by the user must not be carried out by children if not under direct supervision and older than 8 years.

! Installation site:

Place the coffee machine in a safe place, where nobody may overturn it or be injured by it. Do not keep the machine at a temperature below 41°F (5°C) as freezing may damage it. Do not use the coffee machine outdoors.





Do not place the machine on very hot surfaces or close to flames.

The coffee machine shall not be stored inside a cabinet when it's in use.

! Power supply:

The coffee machine shall be connected only to adequate power sockets equipped with grounding means.

The voltage must match the one on the appliance identification plate.

-  **Power supply cable:**
Do not operate the coffee machine if the power cord is damaged. If the power cord is damaged, it must be replaced by the manufacturer (or the latter's technical service staff) or, in any case, by a person duly qualified to do that, in order to prevent any risk. Do not pass the power cable for angles and sharp edges, over very hot objects, and protect it from oil. Do not carry or pull the coffee machine holding it by the power cord. Do not remove the plug by pulling the power cord, do not touch it with wet hands. Power cord should not hang loose from tables or shelves.
-  **Danger of electrocution:**
Live parts should never come into touch with water.
Do not immerse the machine.
-  **Protect children under 8 years of age:**
Prevent children from playing with the machine.
Children are not aware of the risks related to electric household appliances.
Do not leave the machine packaging materials within the reach of children.
-  **Danger of burns:**
Do not touch the hot parts (cartridge holder group) of the machine immediately after use. While dispensing the drink, pay attention to any possible splashes of hot liquid.
-  **Cleaning:**
Before cleaning, unplug the machine and let it cool down.
Do not immerse the machine in water! It is strictly forbidden to tamper with the internal parts of the machine. Change the water in the tank if not used for 3 days.
To prevent damage to the appliance do not use alkaline cleaning agents when cleaning, use a soft cloth and a mild detergent.

**Storing the machine:**

If the machine remains inactive for a long time, unplug it and store it in a dry place out of reach of children. Keep it protected from dust and dirt.

**Servicing / Maintenance:**

In case of failure, problems or a suspected fault resulting from falling of the machine, immediately unplug the machine. Do not attempt to operate a faulty machine.

Only the authorized Lavazza Service Centres can carry out the necessary operations and repairs. Lavazza will not be responsible for possible damage resulting from repairs and operations not carried out by them.

**Water tank:**

Fill the tank only with fresh, non-sparkling, drinking water. Do not operate the machine if the water is not at least above the minimum level indicated on the tank.

**Capsule compartment:**

Only Lavazza **A MODO MIO** or compatible capsules must be introduced in the capsule-holder; do not put in your fingers or any other object.

The capsules shall be used only once.

**Machine disposal at the end of its operational life:**

INFORMATION FOR THE USER: the symbol of the crossed-out wheeled bin on the appliance or its packaging indicates that the product must be disposed of separately from other waste at the end of its operational life.

The user must therefore take the appliance to be disposed of to an appropriate separate collection centre for electrical and electronic equipment.

Appropriate separate waste collection, in view of the decommissioned equipment's recycling, processing and environment-friendly disposal, helps avoiding possible adverse effects both on the environment and the public health and, also, promotes the reuse and/or recycling of the materials the machine is made up of. Specific administrative sanctions provided for by current regulations will be applied for illicit disposal of the product by the user.

PACKAGE CONTENT *

- DESÉA machine
- Welcome kit consisting of 9 assorted Lavazza **A MODO MIO** capsules and a Lavazza **A MODO MIO** leaflet (included only in some countries)
- Instruction booklet
- Quick guide
- Warranty sheet

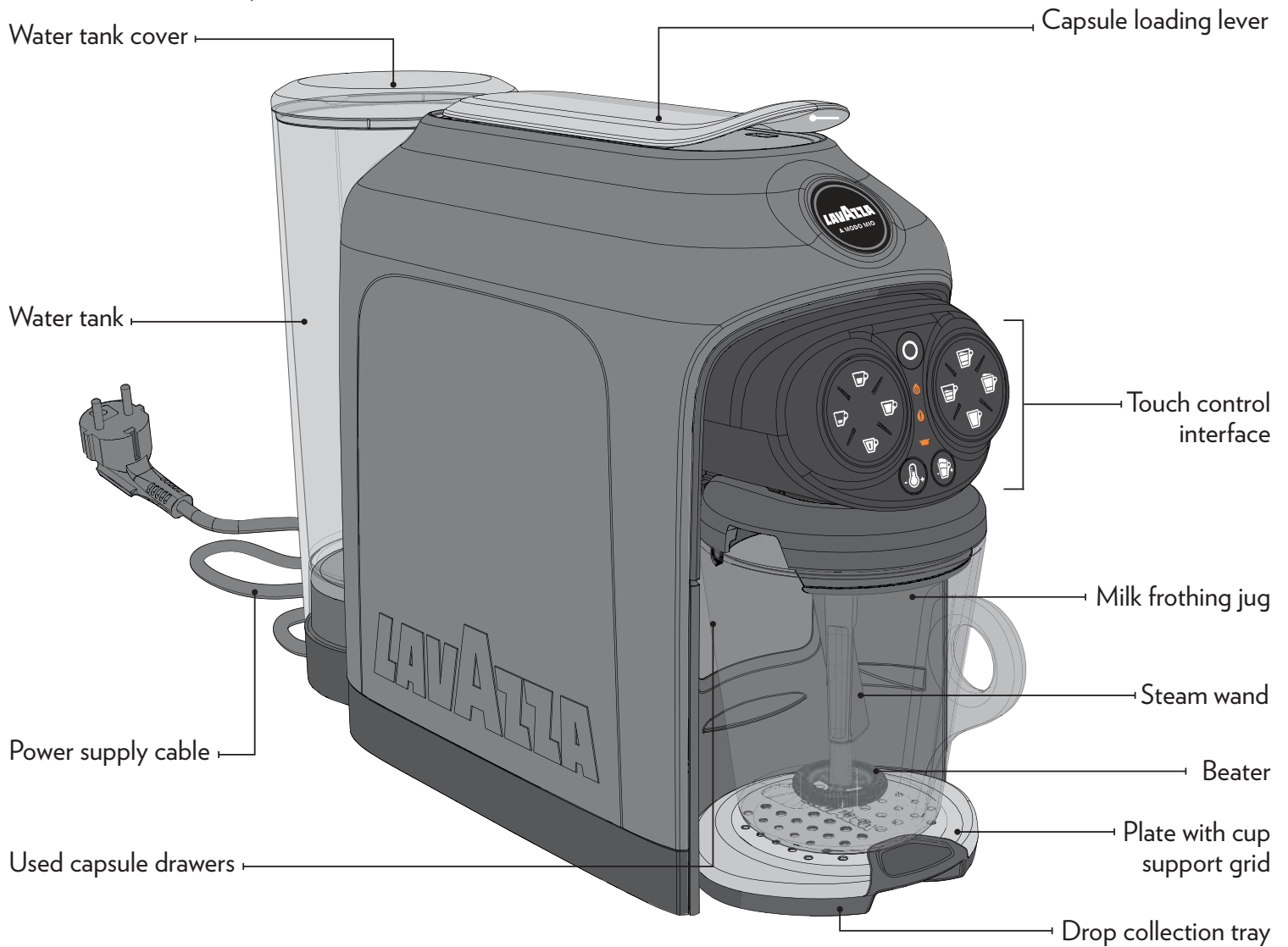

* The characteristics and the package content can vary according to the target market.

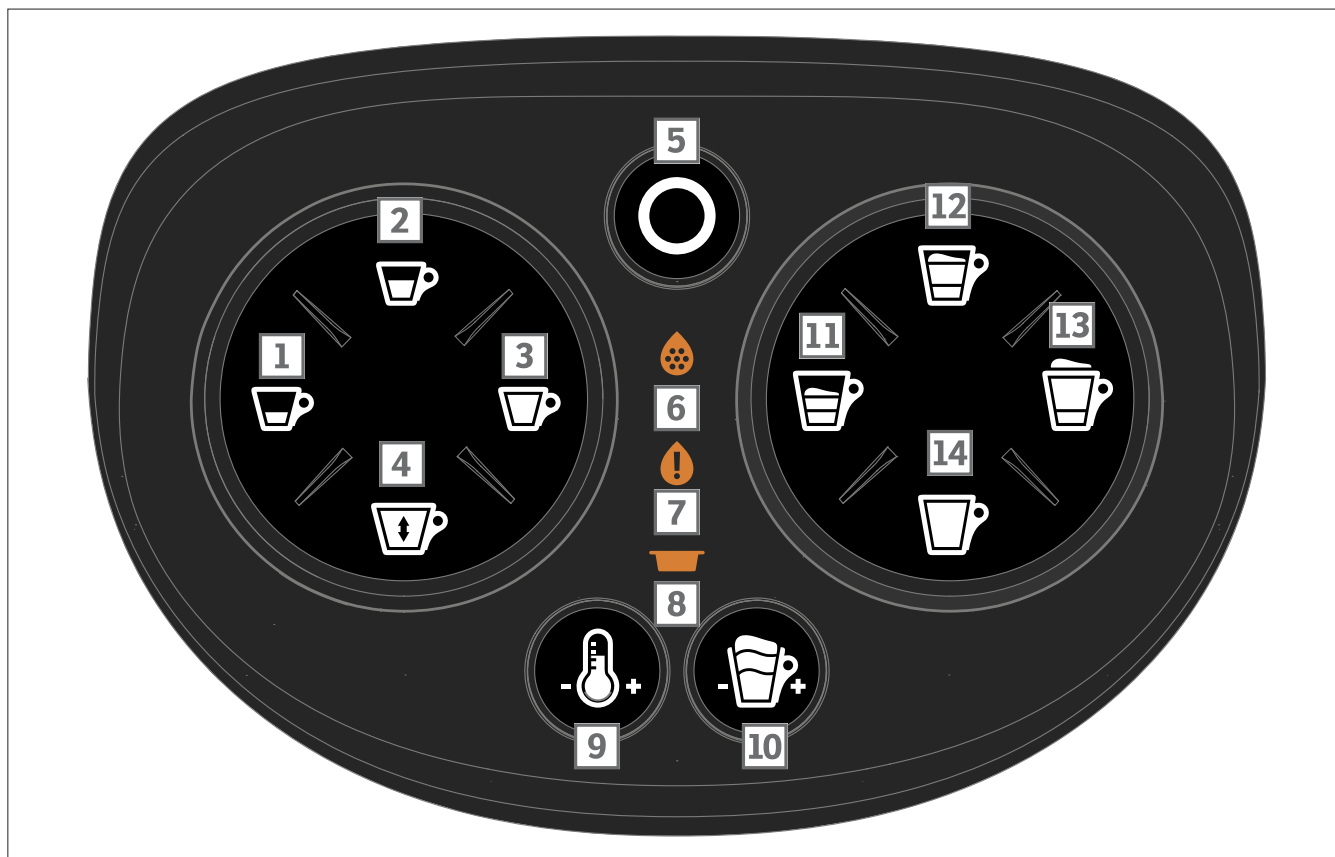

TOUCH CONTROL INTERFACE

- | | |
|---|---|
| 1 ESPRESSO supply button | 8 Warning light drip tray drawer |
| 2 LONG ESPRESSO supply button | 9 TEMPERATURE boost button |
| 3 LONG COFFEE supply button | 10 FOAM control button |
| 4 FREE DOSE BEVERAGE supply button | 11 CAPPUCINO supply button |
| 5 On / Stand-by button | 12 CAPPUCINO LARGE supply button |
| 6 Warning light decalcification | 13 MILK MACCHIATO supply button |
| 7 Warning light no water | 14 HOT / COLD WHIPPED MILK supply button |

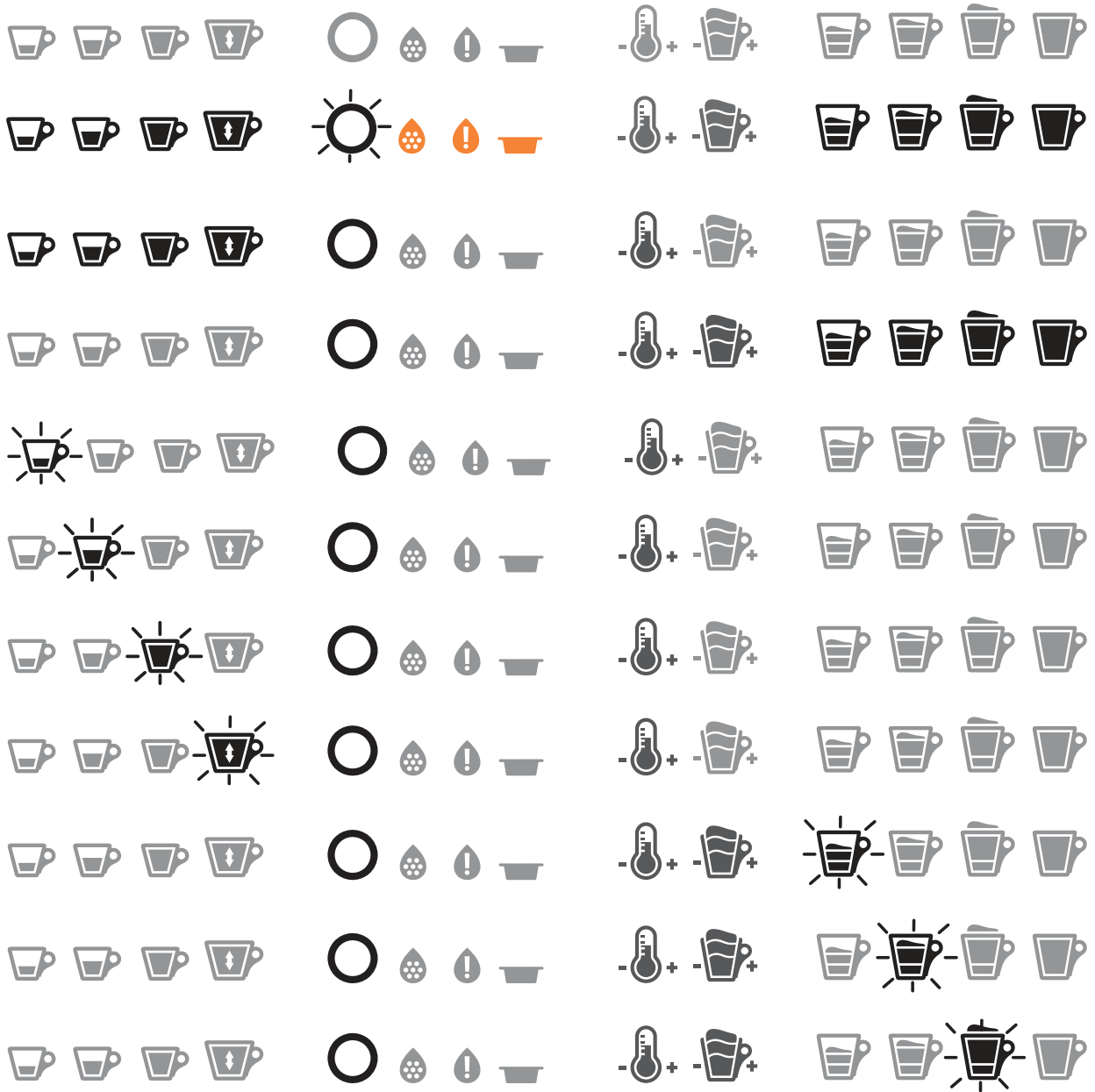

INDICATOR LIGHTS

EN

	Delivering Hot Whipped Milk (button 14)									
	Delivering Cold Whipped Milk (button 14)									
	Programming Espresso measure (button 1)									
	Programming Long Espresso measure (button 2)									
	Programming Long Coffee measure (button 3)									
	Programming Free Dose measure (button 4)									
	No water in tank									
	Used capsule drawer filled									
	Used capsule drawer positioned incorrectly or absent									
	Descaling required									
	Machine Block									

= Off = On = Flashing = Acoustic feedback



- !** We are not liable for any damages in case of:
- incorrect use and other uses than the intended purposes;
 - repairs not carried out at Lavazza authorized service centers;
 - tampering;
 - use of spare parts and accessories which are not original;
 - failure to decalcify;
 - storage in rooms below 39°F (4°C);
 - use below 41°F (5°C);
 - use over 104°F (40°C);
 - use in places with relative humidity above 95%;
 - using non-compatible capsules.
- In any of these cases, the warranty is cancelled.

STARTING THE MACHINE

- !** Place the coffee machine on a flat and stable surface, far from water and heat sources. Machine damages due to non-observance of these indications are not covered by warranty.

- 1** Lift and remove the cover, then the water tank itself.
- 2** Rinse the tank before using it.
- 3** Fill the water tank up to the MAX level indicated, using only fresh drinking water. Fit the tank back into place, then close by using the cover.

i *The cover can be lifted to fill the tank directly.*

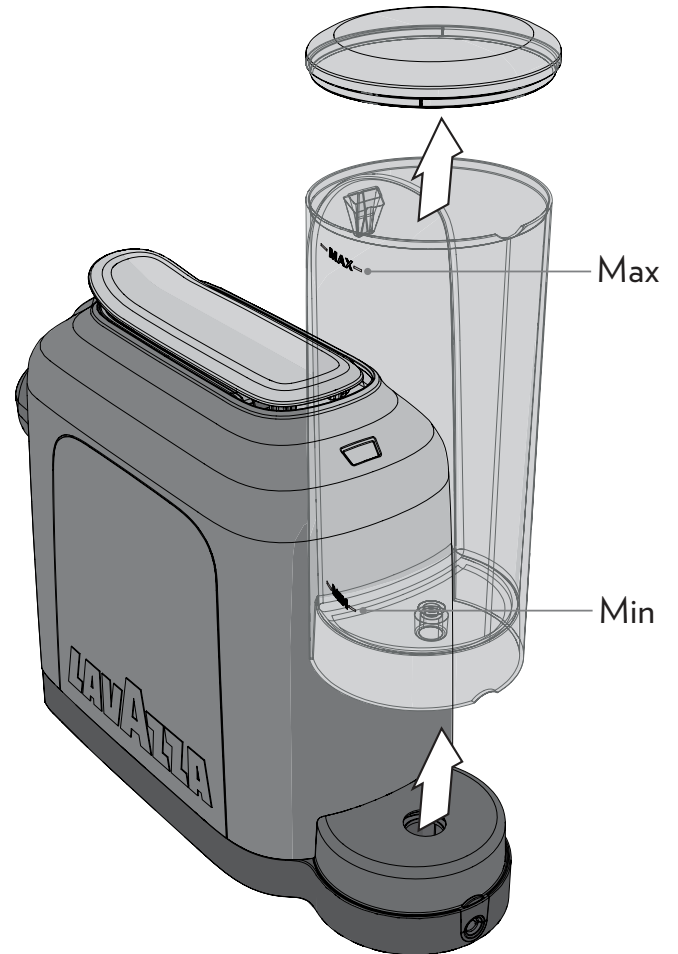

- !** The water level should never exceed the MAX indication.

Only use non-carbonated fresh water. Hot water and other liquids can damage the tank and the machine. Do not operate the machine without water: make sure that there is enough water in the tank.



- !** Make sure that the hands, the machine, the cord and the support surface of the machine are not wet.

MACHINE SETTING

EN

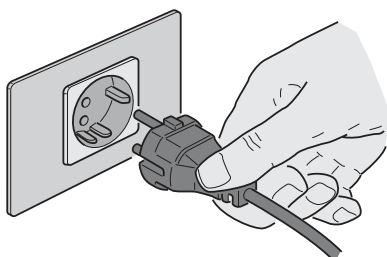
- 4 Fit the supply plug into the power outlet.



- 5 Press the **ON/STAND-BY** button  to switch the machine on. The machine will emit an acoustic signal . All buttons will come on to a steady white light, whereas the alarm warning lamps will come on to a steady orange light over an instant.

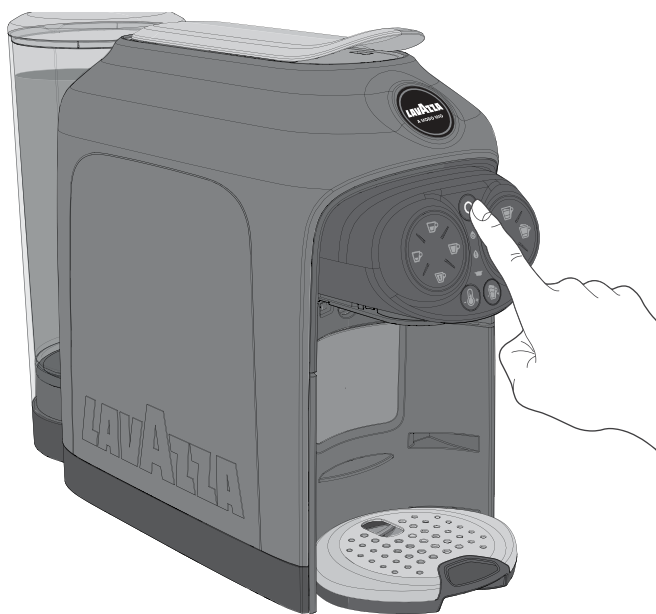

- 6 The coffee machine starts the heating cycle. The **ON/STAND-BY** button  will start blinking to a light white.

- 7 The machine will be ready when the **ON/STAND-BY** button  stops blinking and the supply button lights are steadily.

-  When the milk whipping jug is not inserted, the machine will only turn on the coffee supply buttons and the temperature selection button. The milk beverage warning lights will be **OFF** and the buttons will not work.



-  By pressing one of the supply buttons during the heating cycle, you can reserve the beverage that will be supplied at the end of the heating cycle.

- 8 Upon the first machine start-up, you shall supply 16.9fl oz (0.5 litres) of water, with no capsule inserted and keeping the lever lowered.

- 9** Place a cup under the supplying spout.
- 10** Press the **FREE DOSE**  button and wait for the supply to end.







- i** Open and close the lever before removing and emptying the cup.





- 11** Empty the cup and supply one more time, by pressing the **FREE DOSE**  button again.

- !** When a supply is selected, the machine will activate the electric water pump over 7 seconds. If water is found inside the hydraulic circuit, the machine will normally supply. If no water is found inside the hydraulic circuit, the machine will stop supplying over 5 seconds and will try to supply again up to a maximum of 5 time. After 5 attempts have been made, the machine will cause the “No water” warning lamp  to come on to a steady orange light, to inform that water is missing, and will also emit an acoustic signal.

ACOUSTIC SIGNAL ACTIVATION / DEACTIVATION

- 1** Set the machine to the stand-by mode.
- 2** Simultaneously keep the **ESPRESSO** / **LONG COFFEE**  buttons depressed over at least 5 seconds.
- i** The machine will emit a prolonged acoustic signal  to notify the acoustic signal deactivation, and two brief acoustic signals  to notify the activation.
- 3** Once the procedure has been completed, the machine will go back to the stand-by mode.

STAND-BY FUNCTION

- i** To ensure the energy conservation the machine automatically passes to the **STAND-BY** mode after 9 minutes of not being used. The machine can be manually set to the stand-by mode, before a 9 minutes' time, by pressing the **ON/STAND-BY**  button: the machine will emit an acoustic signal . In the “**STAND-BY**” mode, the buttons will be OFF, and the **ON/STAND-BY** button  will come on to a less intense light. The machine can be activated again by pressing the **ON/STAND-BY**  button.

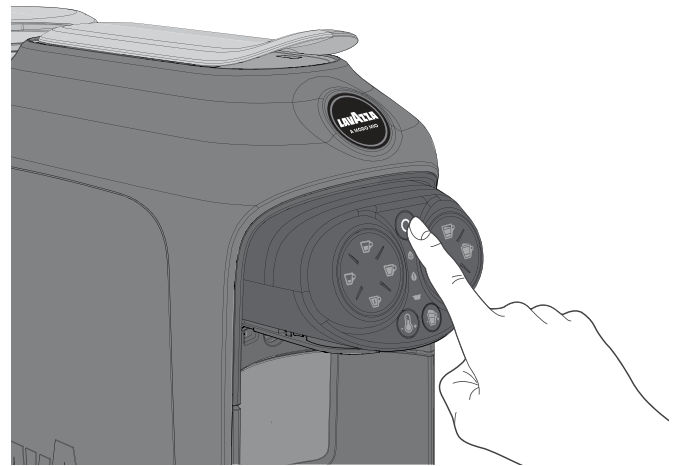

MACHINE SETTING

EN

PREPARATION FOR COFFEE BREWING

The coffee machine features two positions for preparing the coffee: espresso cup/mug.

- 1** To use an espresso coffee cup, remove the cup support plate.

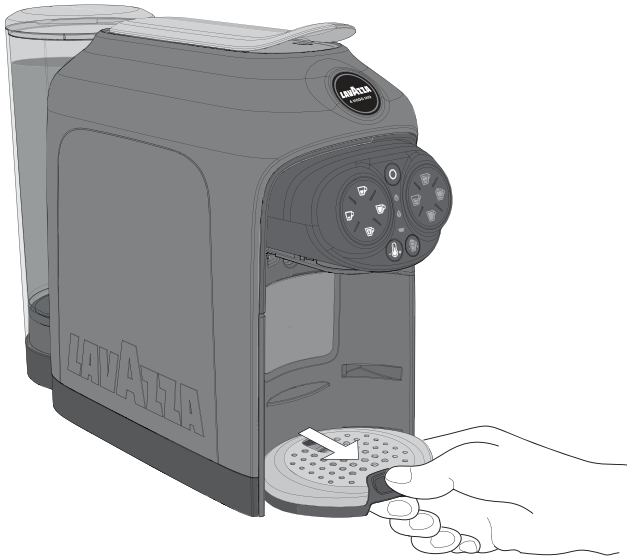

- 2** Fit the cup support plate into the slot available at the top.

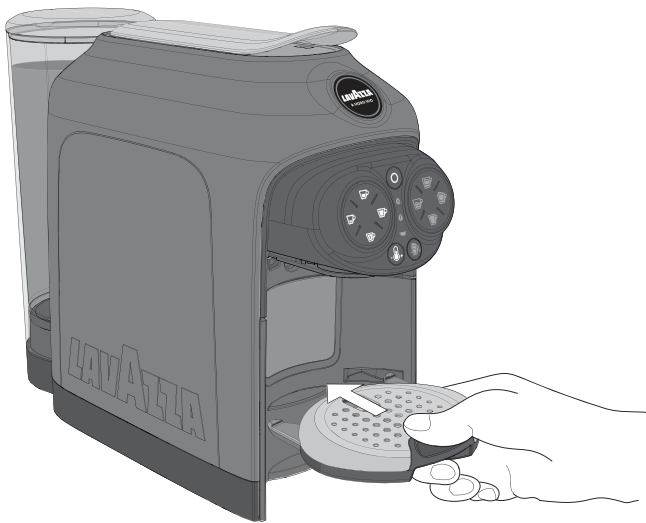

- 3** Place the cup onto the plate.



- 4** To use a big cup, place the cup (or glass) directly onto the plate at the bottom.

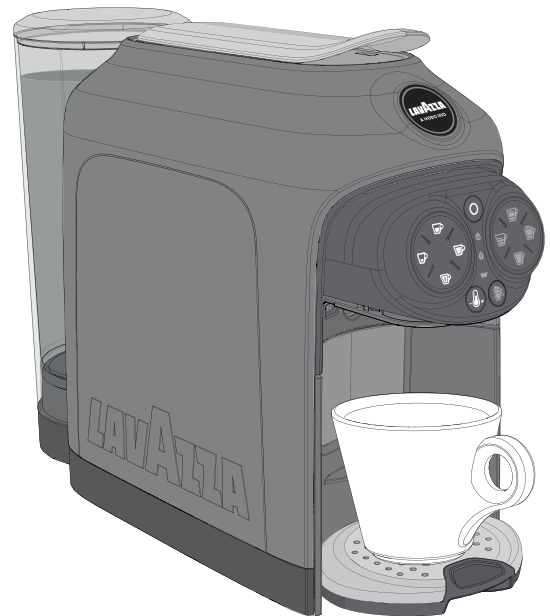

PROVISION FOR PREPARING THE MILK-BASED BEVERAGES

! When the milk whipping jug is inserted, the machine will only turn on the milk-based beverage supply buttons, the temperature selection button and the foam control button. The Coffee beverage warning lights will be OFF and the buttons will not work.



The milk whipping jug features three preparation levels:



 CAPPUCINO

 CAPPUCINO LARGE

 MILK MACCHIATO
WHIPPED MILK

! Always follow the levels indicated inside the milk whipping jug.

1 When using for the first time, carry out a cleaning cycle on the milk frothing jug.

2 Open the milk whipping jug and fill it with fresh, non-carbonated drinking water up to the **MILK MACCHIATO/WHIPPED MILK** level sign  - .



3 Close the milk whipping jug with the cover and pay attention to the correct position and direction of the cover.

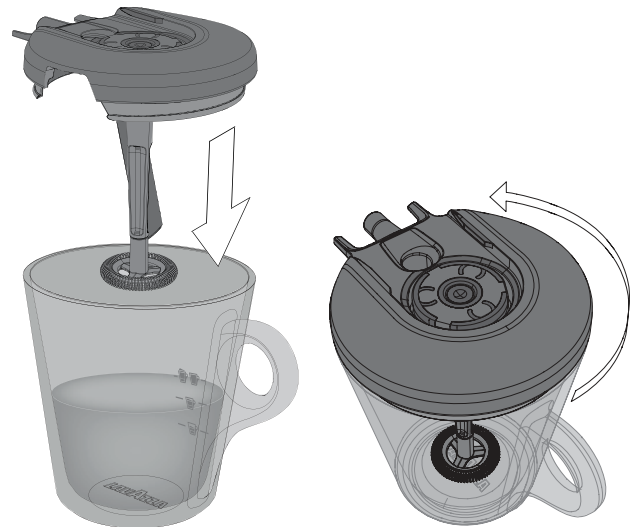

MACHINE SETTING

EN

- 4** Insert the milk whipping jug into the machine.

i The machine will emit an acoustic signal  to indicate the correct insertion of the milk whipping jug.



- 6** After cleaning remove the jug from the machine.



- 5** Press the **MILK MACCHIATO**  button to start the cleaning cycle.

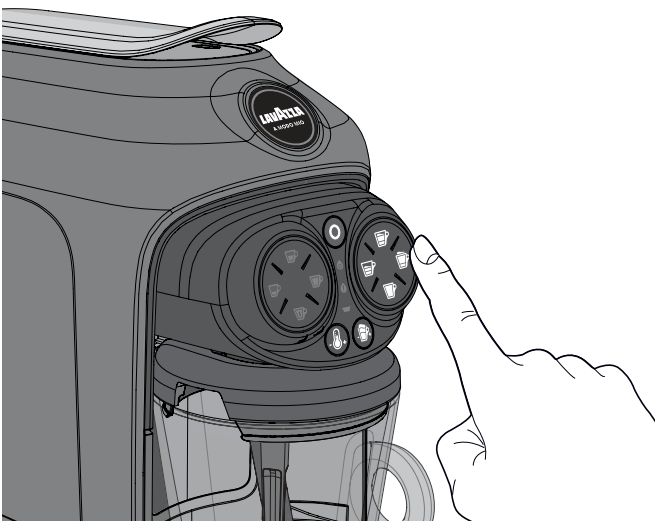

- 7** Wash all the components with cold or warm water, then dry them up and fit them back into place correctly.

ESPRESSO / LONG ESPRESSO DELIVERY

i Make sure that the coffee supply buttons have come on to a steady white light.

- 1** Place the mug/cup as shown (see PREPARATION FOR COFFEE BREWING).
- 2** Lift the capsule loading lever until it locks into position to open the capsule fitting compartment.

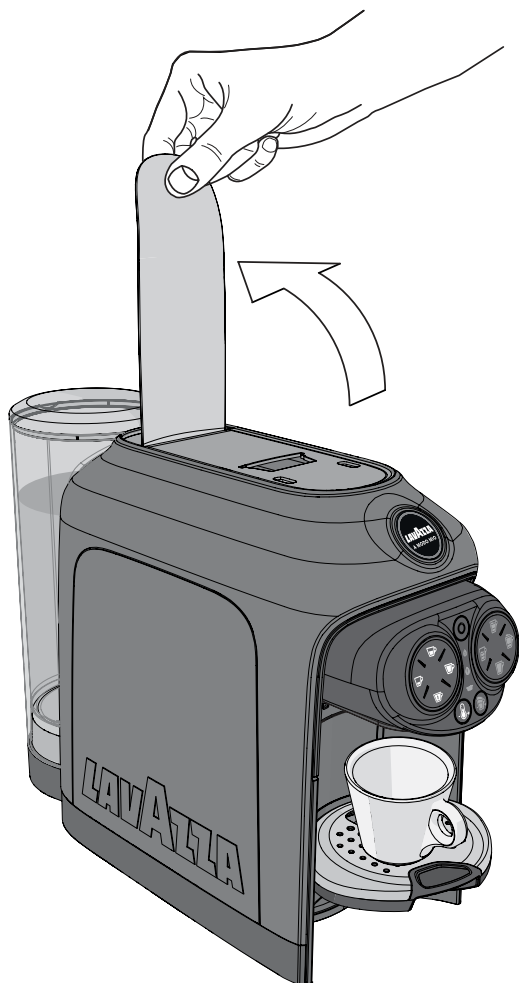

Never put fingers or objects in the capsule-holder

Only Lavazza **A MODO MIO** or compatible capsules must be introduced in the capsule-holder.

Single-dose capsules are prepared to dispense one coffee/product.

DO NOT use the capsules more than once.

Inserting two or more capsules can cause the machine to malfunction.

3

Put a Lavazza **A MODO MIO** capsule into the capsule fitting compartment.





PREPARING THE COFFEE

EN

- 4** Lower the capsule loading lever to close the capsule fitting compartment.



- i** If you wish a hotter coffee, you can increase the beverage temperature by pressing the “**TEMPERATURE boost**” button - .

The machine will, when the button is pressed, emit an acoustic signal  and the button light will get brighter.

If you wish to go back to the standard temperature, press the “**TEMPERATURE boost**” button -  again.

The machine will, when the button is pressed, emit an acoustic signal  and the button light will get dimmer.



- !** The temperature cannot be changed during the supply phase.

- 5** To start supplying:
press the **ESPRESSO** ☕ (1 fl oz /30 ml) or
press the **LONG ESPRESSO** ☕ (1.5 fl oz/45 ml).

The machine will stop delivery automatically when the programmed measure is reached.



- i** The supply button will light up to a blinking white light when the product is being supplied.
You can stop supplying by pressing the supply button again.

! If, during the dispensing cycle power supply is interrupted proceed as follows:

- Restore the power supply.
- Press the **ON/STAND-BY** button ○ and wait for the button to light up to a steady white light.
- Replace the capsule inside the capsule fitting compartment with a new one.
- Restart the coffee dispensing.

! If, during the dispensing cycle water ⚠ is exhausted within the tank proceed as follows:

- Fill the water tank up to the indicated **MAX** level.
- Replace the capsule inside the capsule fitting compartment with a new one.
- Restart the coffee dispensing.

! Supplying without a capsule the doses may not respect the programmed quantity.

- 6** Once supply is over, lift and then lower the capsule loading lever to unload the exhausted capsule.

- 7** To supply again, wait until both the supply button and the **ON/STAND-BY** button ○ come on to a steady white light.

PREPARING THE COFFEE

EN

LONG COFFEE DELIVERY

! Do steps: **1**, **2**, **3** and **4** in paragraph ESPRESSO DELIVERY.

- 5** Press the **LONG COFFEE**  (3 fl oz/90 ml) button to start delivery. The machine will stop delivery automatically when the programmed measure is reached.



i The supply button will light up to a blinking white light when the product is being supplied. You can stop supplying by pressing the supply button again.

- 6** Once supply is over, lift and then lower the capsule loading lever to unload the exhausted capsule.
- 7** To supply again, wait until both the supply button and the **ON/STAND-BY** button  come on to a steady white light.

FREE DOSE BEVERAGE DELIVERY

! Do steps: **1**, **2**, **3** and **4** in paragraph ESPRESSO DELIVERY.

i In case of soluble capsules, it is recommended that a brief plain (i.e. by using only water) supply should be dispensed before inserting the capsule, so that you can best enjoy the product.

- 5** Press the **FREE DOSE BEVERAGE**  button to start delivery. Once the desired amount of brewed coffee is reached, press the button again to stop brewing.

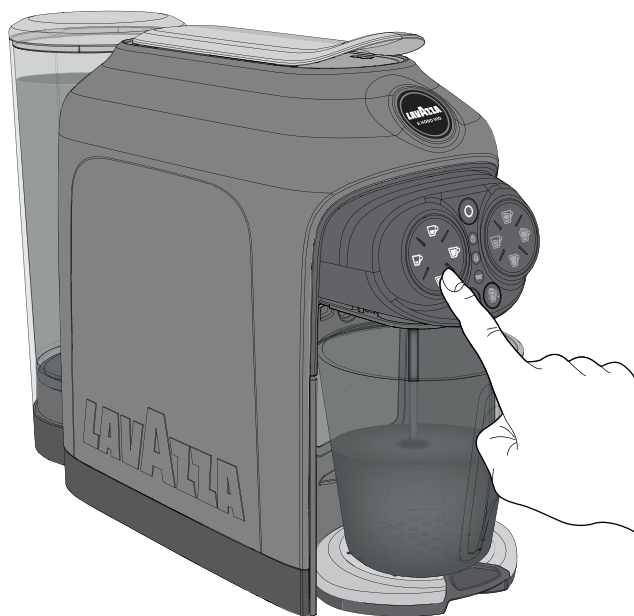

i The supply button will light up to a blinking white light when the product is being supplied. You can stop supplying by pressing the supply button again.

- 6** Once supply is over, lift and then lower the capsule loading lever to unload the exhausted capsule.
- 7** To supply again, wait until both the supply button and the **ON/STAND-BY** button  come on to a steady white light.

COFFEE DOSE PROGRAMMING

i Measures are always programmed using the same button; any action by pressing other buttons will be ignored. The programmed amount of brewed coffee can be changed by repeating the programming.

! It is not possible to program the coffee dose in milk-based beverages.

- 1** Press the **ON/STAND-BY** button  to switch the machine on. The machine will be ready when the **ON/STAND-BY** button  stops blinking and the supply button lights are steadily.
- 2** Lift the pod loading lever until it locks into position to open the pod fitting compartment.
- 3** Put a Lavazza **A MODO MIO** capsule into the capsule fitting compartment.
- 4** Lower the pod loading lever to close the pod fitting compartment. Place the cup onto the plate.



- 5** Press down the button of the icon you wish to program. The machine will start supplying and, after approximately 3 seconds, the other coffee buttons will start blinking and the machine will beep , to indicate that the programming mode has been accessed.
- 6** Keep the supply button depressed
- 7** Once the desired amount of coffee has been obtained, stop supply by releasing the button. The machine will stop and the dose will be programmed



- i** If the programmed measure exceeds the maximum allowed the machine will automatically stop delivery, the delivery button will blink and the last programmed measure will be saved in the memory.
If there is a power failure during programming, the last programmed value remains in the memory.
If during a dose programming, water lack  is indicated, the machine stops the supply and the dose being programmed won't be saved. Once filled the water tank, repeat the dose programming procedure.

PREPARING THE MILK-BASED BEVERAGES

EN

DELIVERING CAPPUCCINO

! When the milk whipping jug is inserted, the machine will only turn on the milk-based beverage supply buttons, the temperature selection button and the foam control button. The coffee beverage warning lights will be **OFF** and the buttons will not work.

1 Open the milk whipping jug and fill it with milk up to the **CAPPUCCINO**  level sign.

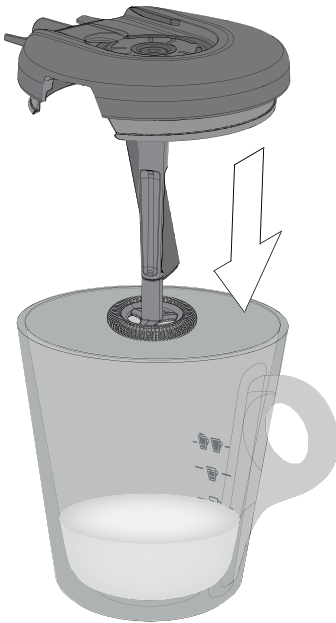

! Pour the exact amount of milk indicated on the jug. Do not pour too much milk or too little milk. Otherwise, hot milk may in both cases spill out of the container.

i Use only cold milk at the fridge temperature 39°F-46°F (4-8°C). Do not use milk at room temperature. Using soy milk will not guarantee the best results.

2 Close the milk whipping jug and fit it into the machine.

i When the milk frothing jug is correctly positioned, the machine emits a beep .



! Make sure that the milk whipping jug has been correctly put in place and, also, that the beverage supply buttons are **ON** with a steady white light.

- 3** Put a **Lavazza A MODO MIO** capsule into the capsule fitting compartment.

! Check that a capsule has been inserted. If there is no capsule, the machine will delivery water, not coffee.

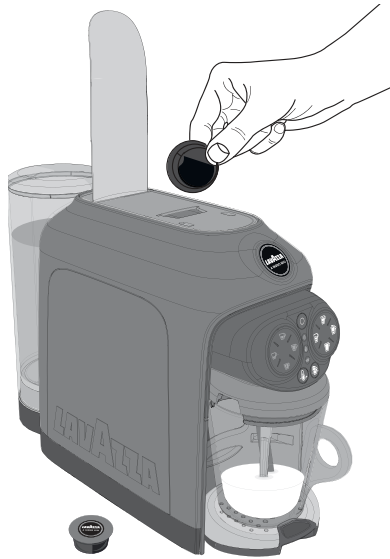

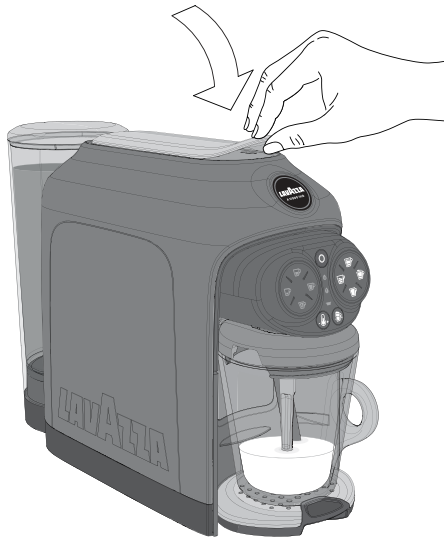

- 4** Lower the capsule loading lever to close the capsule fitting compartment.

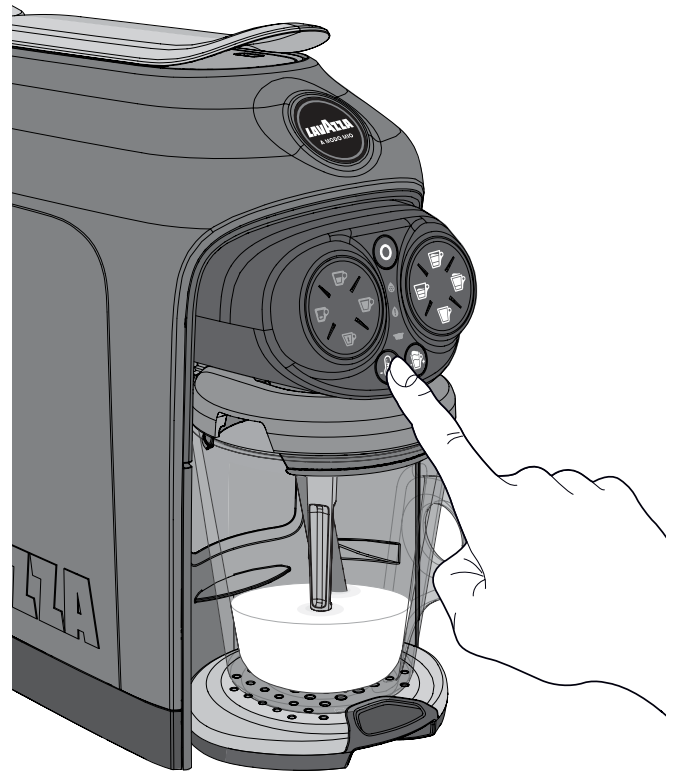

- i** If you wish a hotter coffee, you can increase the beverage temperature by pressing the **“TEMPERATURE boost”** button .

The machine will, when the button is pressed, emit an acoustic signal  and the button light will get brighter.



- i** If you wish to go back to the standard temperature, press the **“TEMPERATURE boost”** button  again.

The machine will, when the button is pressed, emit an acoustic signal  and the button light will get dimmer.

- !** The temperature cannot be changed during the supply phase.

PREPARING THE MILK-BASED BEVERAGES

EN

- i** If you wish more foam in the beverage, you can increase the amount of the same by pressing the **FOAM** control button .

The machine will emit an acoustic signal  when the button is pressed.

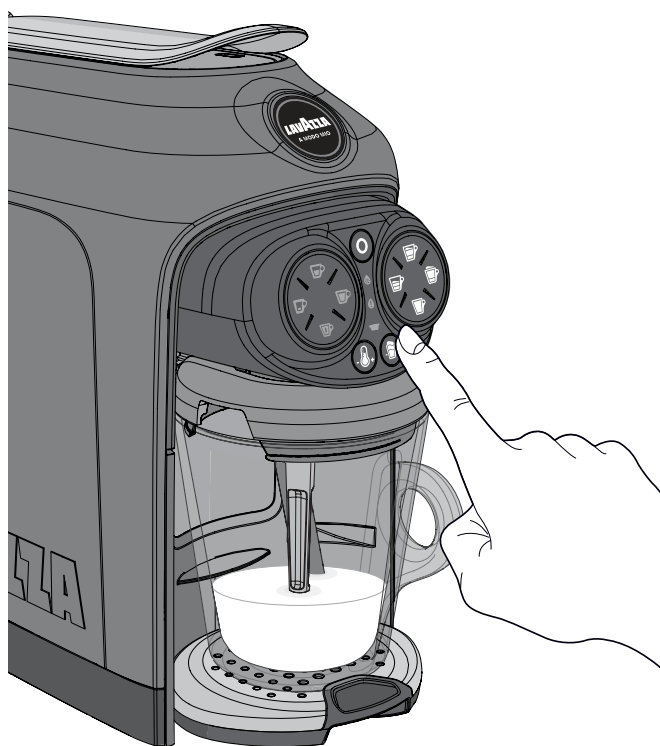

- i** If you wish to go back to the normal foam amount, press the **FOAM** control button again .

The machine will emit an acoustic signal  when the button is pressed.

- !** The foam amount cannot be changed when the beverage is being supplied.

- 5** Press the **CAPPUCCINO**  2.8fl oz (80 ml) button to start the machine. After a few seconds the machine will start to warm and froth the milk. When ready, the machine delivers the measure of coffee in the jug and stops automatically.

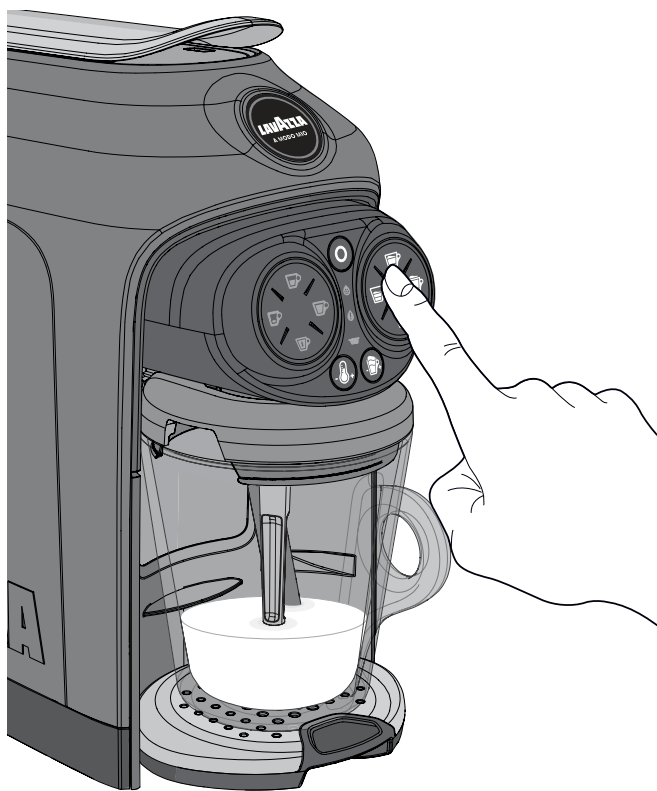

- !** Do not use the milk frothing jug to conserve the beverages. Always clean the jug thoroughly after each use.

- i** The supply button will light up to a blinking white light when the product is being supplied. You can stop supplying by pressing the supply button again.

- !** Do not make more than 5 consecutive beverages. The machine will be ready to use again after about 10 minutes.

DELIVERING CAPPUCCINO LARGE

- 1** Open the milk whipping jug and fill it with milk up to the **CAPPUCCINO LARGE**  level sign.

! Do steps: **2**, **3** and **4** in paragraph **CAPPUCCINO DELIVERY**.

- 5** Press the **CAPPUCCINO LARGE**  4.5 fl oz (130 ml) button to start the machine.

After a few seconds the machine will start to warm and froth the milk.

When ready, the machine delivers the measure of coffee in the jug and stops automatically.

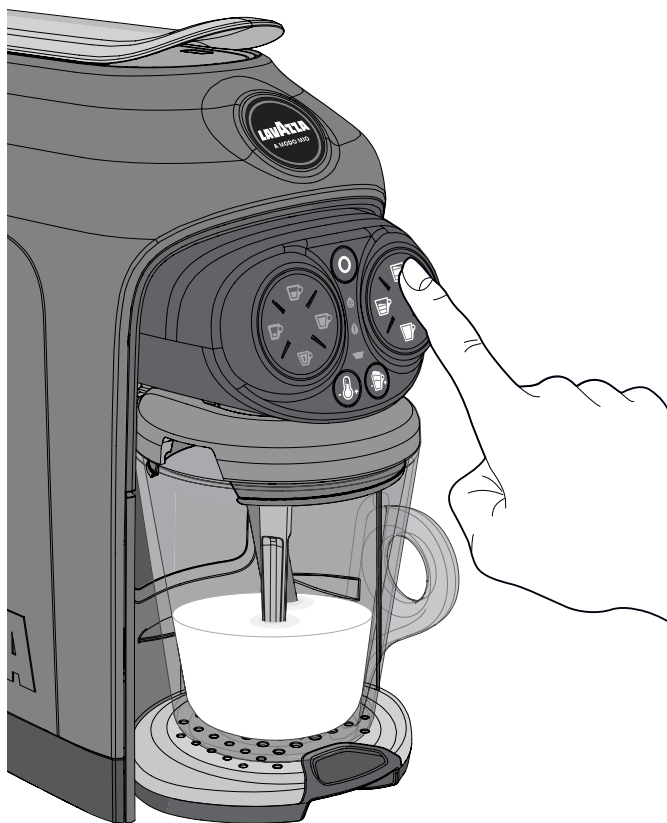

DELIVERING MILK MACCHIATO

- 1** Open the milk whipping jug and fill it with milk up to the **MILK MACCHIATO**  level sign.

! Do steps: **2**, **3** and **4** in paragraph **CAPPUCCINO DELIVERY**.

- 5** Press the **MILK MACCHIATO**  6.1 fl oz (175 ml) button to start the machine.

After a few seconds the machine will start to warm and froth the milk.

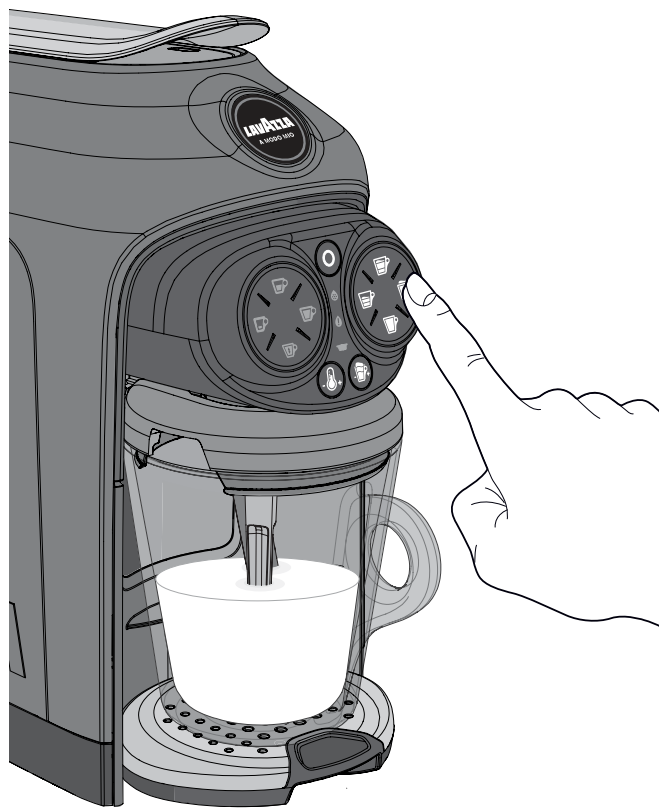

When ready, the machine delivers the measure of coffee in the jug and stops automatically.



PREPARING THE MILK-BASED BEVERAGES

EN



DELIVERING HOT WHIPPED MILK

- 1 Open the milk whipping jug and fill it with milk up to the **MILK MACCHIATO / WHIPPED MILK**  -  level sign.
- 2 Close the milk whipping jug and fit it into the machine.
- 3 Press the **HOT WHIPPED MILK**  button 6.1 fl oz (175 ml) to start the preparation.

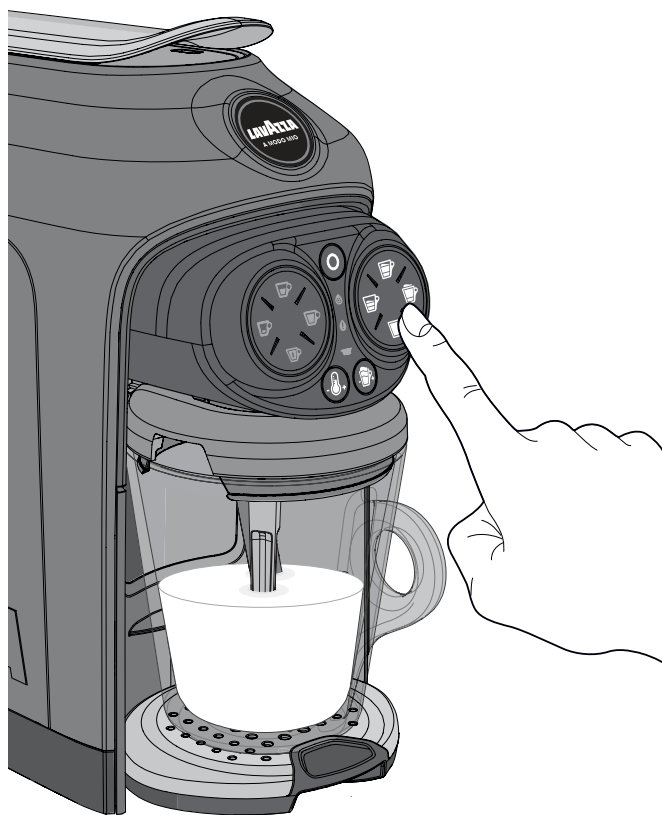
After a few seconds, the machine will start warming and whipping the milk.



DELIVERING COLD WHIPPED MILK

- 1 Open the milk whipping jug and fill it with milk up to the **MILK MACCHIATO / WHIPPED MILK**  -  level sign.

! Pour the exact amount of milk indicated on the jug. Do not pour too much milk or too little milk. Otherwise, hot milk may in both cases spill out of the container.

i Use only cold milk at the fridge temperature 39°F-46°F (4-8°C). Do not use milk at room temperature. Using soy milk will not guarantee the best results.

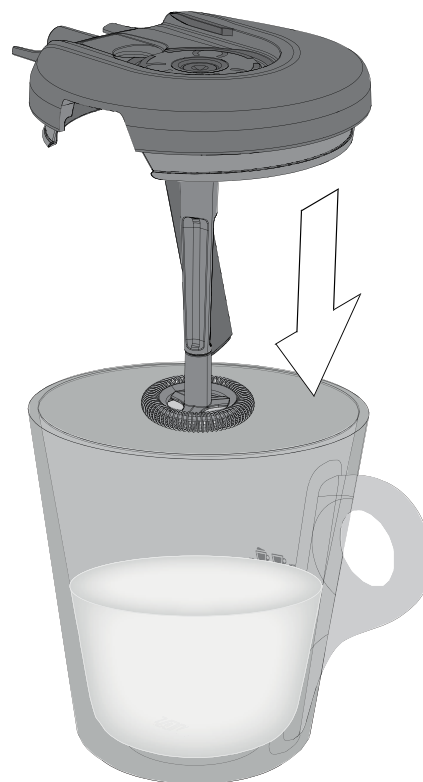



2 Close the milk whipping jug and fit it into the machine.

i When the milk frothing jug is correctly positioned, the machine emits a beep .

! Make sure that the milk whipping jug has been correctly put in place and, also, that the beverage supply buttons are ON with a steady white light.

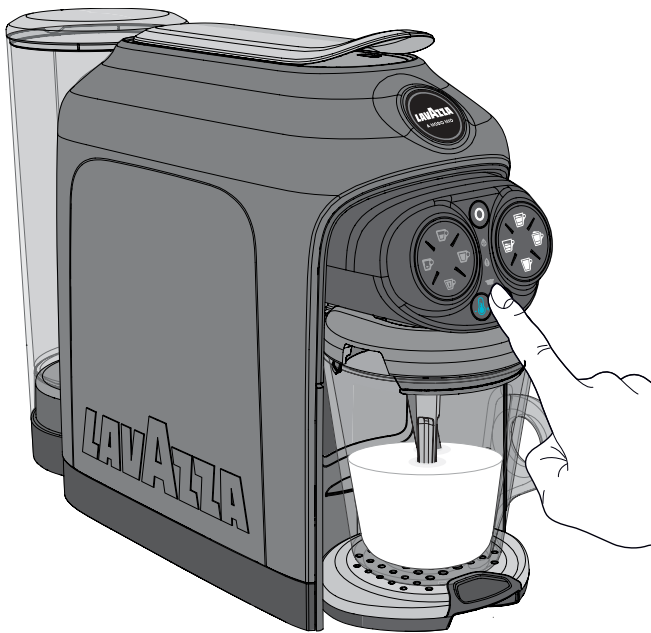
3 Keep the **TEMPERATURE Boost** button + depressed over at least 3 seconds.



i The machine will emit a double acoustic signal  to indicate the shift to the cold beverage preparation.

! Both the **TEMPERATURE Boost** button  and the **COLD WHIPPED MILK**  icon will turn blue and the machine will only enable the **COLD WHIPPED MILK** supply button .

4 Press the **COLD WHIPPED MILK** button  6.1 fl oz (175 ml) to start the preparation. After a few seconds, the machine will start whipping the milk.

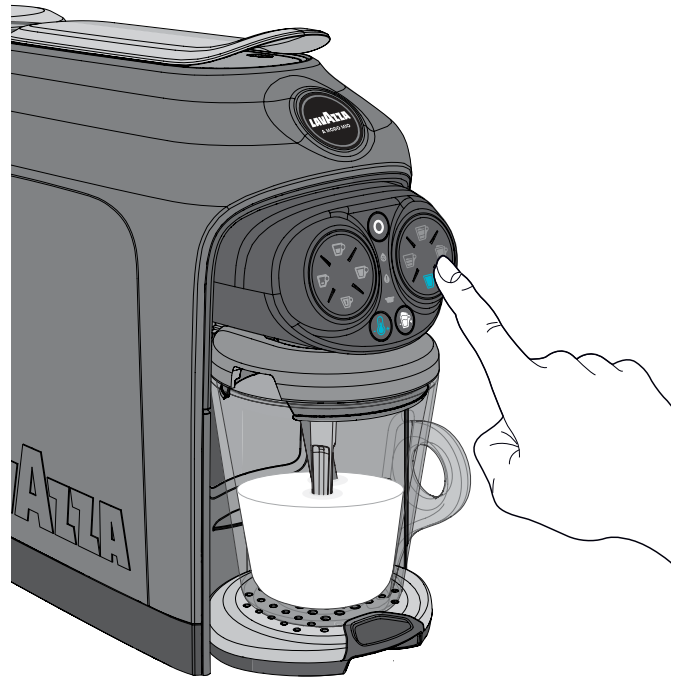

! Do not use the milk frothing jug to conserve the beverages. Always clean the jug thoroughly after each use.

i When the beverage is being supplied, the selected button will be ON with a blinking blue light.

5 To supply again, wait until both the supply button and the **ON/STAND-BY** button  come on to a steady white light.

! Do not make more than 5 consecutive beverages. The machine will be ready to use again after about 10 minutes.

CLEANING THE MACHINE

! Never use solvents, alcohol or other aggressive substances or ovens for drying the coffee machine components.

Wash machine components (electric components excluded) with cold/lukewarm water and non-abrasive clothes/sponges.

All removable components can be cleaned by using a dishwasher.

Do not leave water in the tank and water circuit for more than 3 days. If this is the case, drain the tank and circuit, rinse it and refill it with fresh water, then carry out a delivery without capsule before making any coffee or other beverage.

COFFEE DISPENSER CLEANING

To clean the dispenser, perform a weekly **COFFEE BREWING** procedure without inserting the capsule.



CLEANING THE DROP COLLECTION TRAY AND THE USED CAPSULE COLLECTION TRAY

i The capsule collection tray warning lamp  will come on when the used capsule tray is full and, therefore, has to be emptied and fitted back into place again.

1 Remove the drop collection tray and the used capsule collection tray.

i The machine will emit an acoustic signal  to inform that the capsule collection tray has been removed.

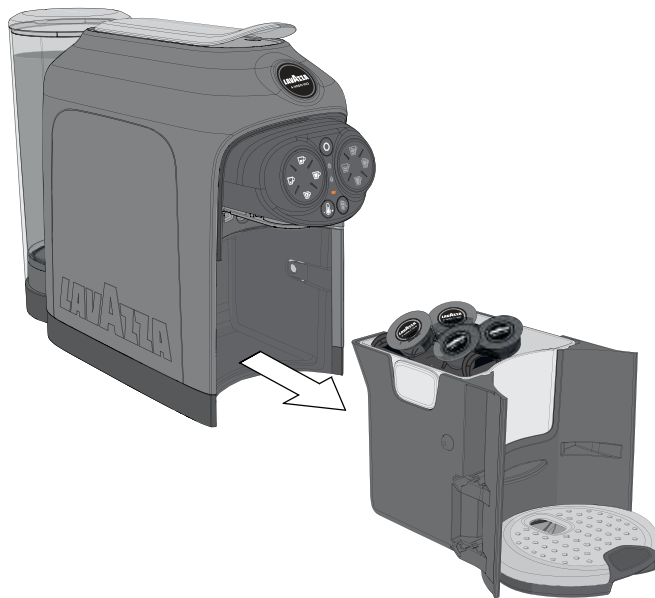

i If the drawer is removed for more than 5 seconds, the machine will zero the capsules inserted count.

- 2** Remove the drop collection tray and the capsule collection tray, then empty the used capsules and the fluids found in the drop collection tray.

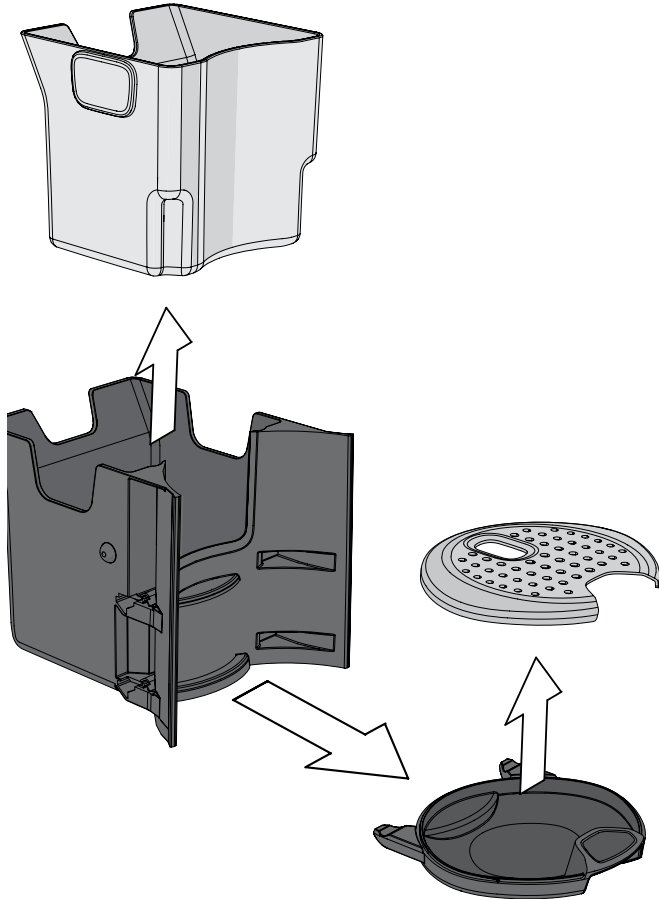

- 3** Wash all the components with cold or warm water, or in a dishwasher, then dry them up and fit them back into place correctly.

i Regularly check that the drop collection tray is not full, so as to prevent fluid leakage.

CLEANING MILK FROTHING JUG

- 1** Open the milk frothing jug and separate its components.

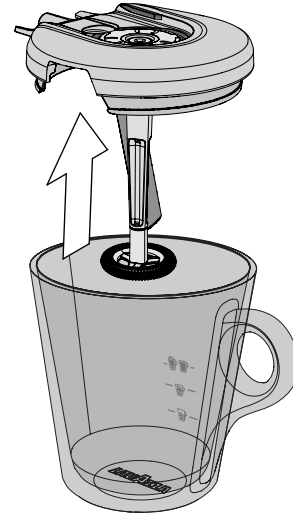

- 2** Remove the steam wand from the milk whipping jug cover.

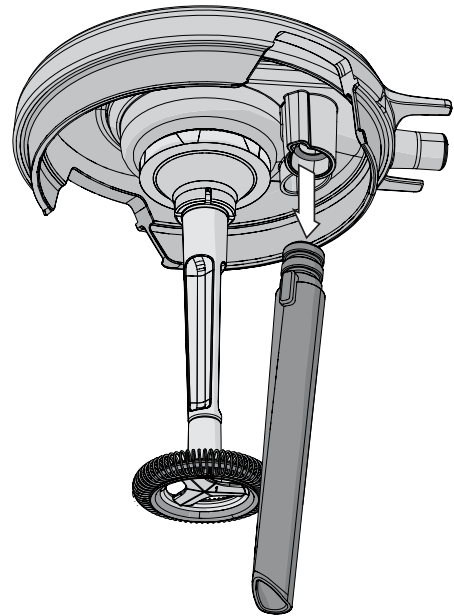

MAINTENANCE AND CLEANING

EN

- 3** Wash all the components with cold or warm water.

i Wash the jug, the whisk and the steam nozzle in cold water or in a dishwasher at low temperature. Wash the components separately.

- 4** Fit the steam wand onto the milk whipping jug cover.

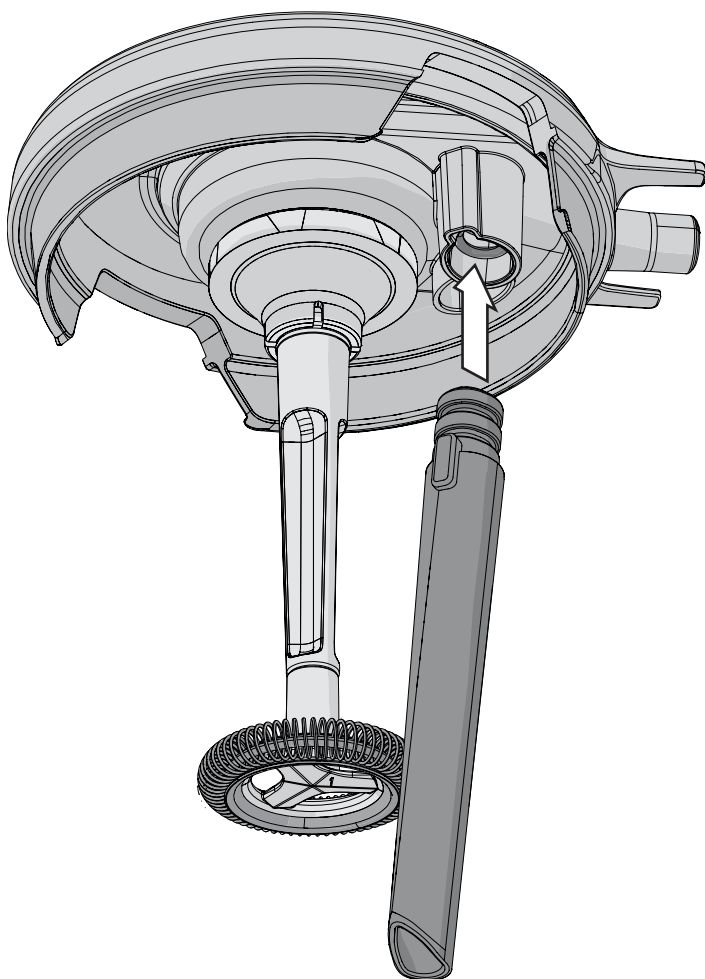

- 5** Fit the cover onto the milk whipping jug.

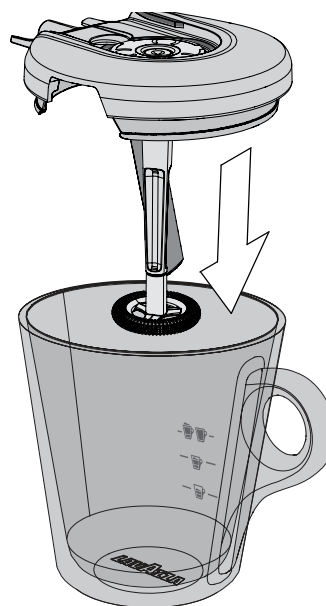

- 6** Close the milk whipping jug with its cover and pay attention to the correct position and direction of the cover.

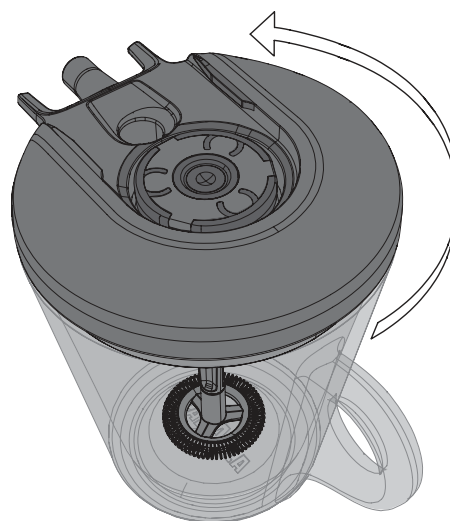

- ⚠ Prior to starting the machine, check the machine serial number that is printed under the Bar Code in the label underneath the machine and find the operating instructions in the dedicated section.

DESCALING AS REGARDS MACHINES WITH SERIAL NUMBER FROM 2231S001116896 TO 2232S001116943 FROM 2244S001120116

- ⚠ Carefully read the descaling instructions.

Limescale normally builds up with extended use of the appliance; the machine needs descaling every 2 months and/or whenever a reduction in water flow is noticed. The descaling cycle will be requested by the machine through the switching-on of the special warning lamp 🚫.

- ⚠ Do not switch the machine off when the descaling cycle is under way.

The machine must be monitored during the descaling cycle. The cycle will have, once it has been started, to be performed completely.

Check there is no capsule inside the capsule containing compartment.

The milk frothing jug MUST be inserted during the descaling cycle.

Items needed for descaling:



Milk frothing jug

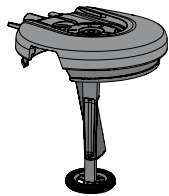

Milk frothing jug cover



Capsule tray and drop collection tray

- 1 Remove and empty the water tank and remove the milk whipping jug.

- ⚠ Do not drink the descaling solution and products dispensed until the completion of the cycle. Never use vinegar as a descaling solution.

- i To decalcify the machine, It is recommended that the **LAVAZZA DESCALING** agent should be used.

- 2 Fill the tank with the **LAVAZZA DESCALING** agent 8.7fl oz (250 ml) and water 8.7fl oz (250 ml). Fit the tank back into place on the machine.



- i Use a moist cloth to wipe off the squirts or drops, if any.

- 3 Put the tank back in place on the machine.

- 4 Place the milk frothing jug (complete with its cover) into position on the machine.

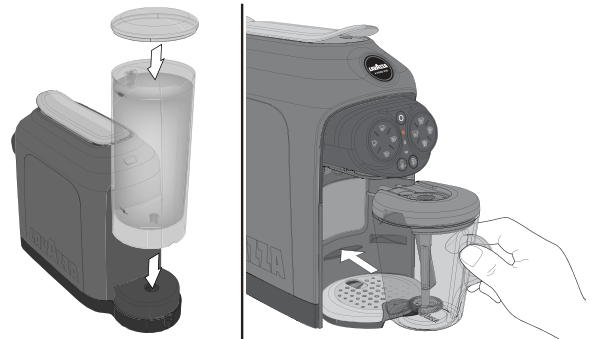

MAINTENANCE AND CLEANING

EN

- 5** Keep, with the machine in the stand-by mode, the **LONG ESPRESSO** ☕ and **FREE DOSE** ☕ supply buttons simultaneously depressed over at least 3 seconds.

i The machine will emit a prolonged acoustic signal 🗣️*, then the: **ON/STAND-BY** ⏻, and **LONG COFFEE** button ☕ and the descaling warning lamp will all come on to a steady light 🔆.

* The acoustic signals will not be emitted if they have been turned OFF.

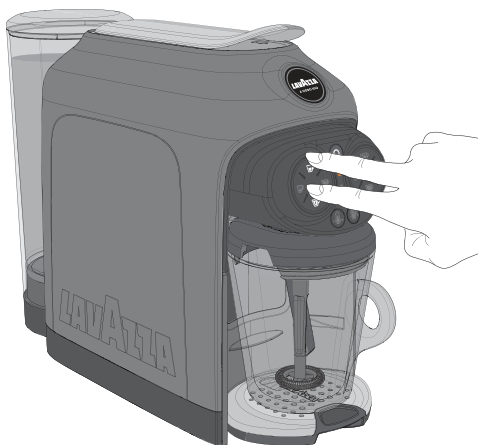

- 6** Press the **LONG COFFEE** button ☕ to start the descaling cycle.

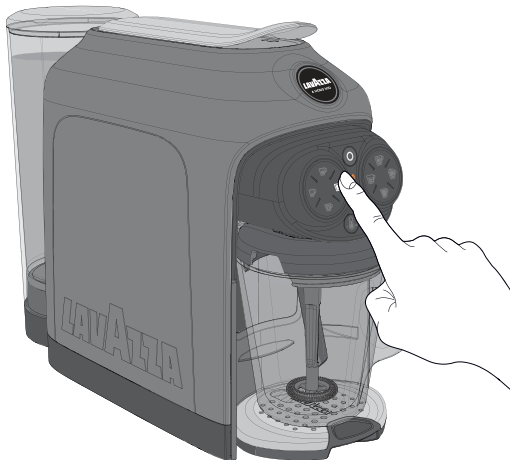

- !** If the **LONG COFFEE** button ☕ is not pressed within 9 minutes after the acoustic signal has been emitted, the machine will go back to the “Stand-by” mode and the step **5** in the procedure shall be repeated, to start the cycle.

In case of power supply interruption, the machine will, upon the first power-on, resume the descaling procedure where it was interrupted: press the **LONG COFFEE** button ☕ to restart **DESCALING**.

- 7** The machine will automatically activate the descaling process, after the heating cycle is over.

i During the descaling cycle, the **LONG COFFEE** button ☕ will be ON and blinking and the descaling warning lamp 🔆 will be ON to a steady light.

- !** During the descaling cycle, the machine will automatically perform intermittent supply cycles, to allow the container to be emptied.





i The descaling cycle can be temporarily interrupted by pressing either the **LONG COFFEE** button ☕ ON/STAND-BY button ⏻. To start the cycle again, press the **LONG COFFEE** button ☕.

- 8** The cycle will be temporarily interrupted when the fluid runs out in the machine tank.

! **DO NOT** top up the tank during this phase.
You must allow the tank to empty completely.

- 9** Empty the milk frothing jug used to collect the descaling solution.

i **ON/STAND-BY** , **LONG COFFEE** button  and "No water" warning lamp  will be **ON** to a steady light. Descaling warning lamp  will be **ON** and **blinking**.

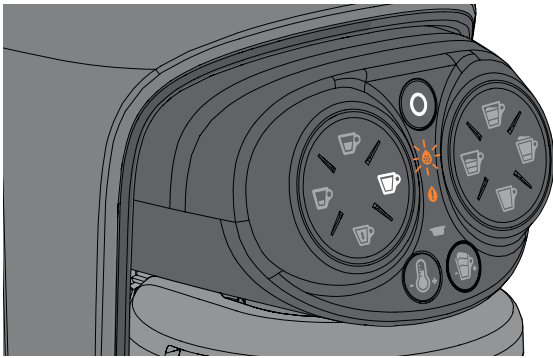

- 10** Remove the water tank, rinse and wash it accurately. Fill it with drinking fresh non-carbonated water up to the **MAX.** level.

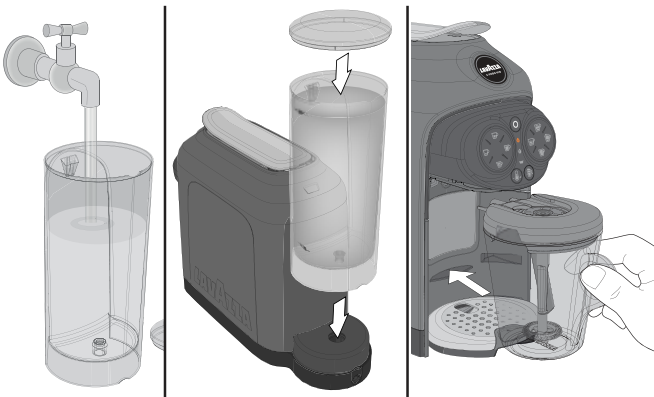

! In case of power supply interruption, the machine will, upon the first power-on, resume the rinse procedure where it was interrupted: press the **LONG COFFEE** button  to restart **RINSING**.

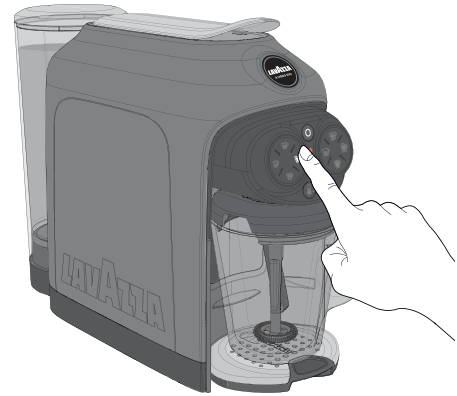

- 11** Fit the tank with water. Place the milk frothing jug (complete with its cover) back into position on the machine.

- 12** Press the **LONG COFFEE** button  to start the rinsing cycle.



- 13** At the end of the first rinse cycle, refill the water tank and start the second rinse cycle by pressing the **LONG COFFEE** button .

i To end the rinse cycle, a minimum amount of water of **67.62 fl oz (2 litres) (approximately 2 tanks)** will have to be supplied.

In case of lack of water, the cycle will be temporarily interrupted, the machine will emit a prolonged acoustic signal  (if enabled) and the "No water  warning lamp will come on to a steady light.

Top up the tank and press the **LONG COFFEE** button  again to restart the rinse cycle

- 14** At rinse end, the descaling warning lamp goes off, which confirms that the procedure has come to an end. Before using the machine, empty and thoroughly rinse the milk frothing jug and its cover, clean it using a soft moist cloth.

MAINTENANCE AND CLEANING

EN

**DESCALING AS REGARDS MACHINES WITH SERIAL NUMBER:
FROM 1947S001034763 TO 231S001116895
FROM 2242S001116944 TO 2244S001120115**

i The machine serial number is shown below the barcode on the label put under the machine.

! Carefully read the descaling instructions.

Limescale normally builds up with extended use of the appliance; the machine needs descaling every 2 months and/or whenever a reduction in water flow is noticed. The descaling cycle will be requested by the machine through the switching-on of the special warning lamp available .

! Do not switch the machine off when the descaling cycle is under way.

The machine must be monitored during the descaling cycle.

The cycle will have, once it has been started, to be performed completely.

Check there is no capsule inside the capsule containing compartment.

1 Remove and empty the water tank and remove the milk whipping jug.

! Do not drink the descaling solution and products dispensed until the completion of the cycle. Never use vinegar as a descaling solution.

i To decalcify the machine, It is recommended that the **LAVAZZA DESCALING** agent should be used.



2 Fill the tank with the **LAVAZZA DESCALING** agent 8.7fl oz (250 ml) and water 8.7fl oz (250 ml).

3 Fit the tank back into place on the machine.





i Use a moist cloth to wipe off the squirts or drops, if any.



4 Place a container with a capacity of at least 16.9 fl oz (0.5 L) under the supplying device.

5 Keep, with the machine in the **STAND-BY** mode, the **LONG ESPRESSO**  and **FREE DOSE**  supply buttons simultaneously depressed over at least 3 seconds.





i The machine will emit a prolonged acoustic signal *, then the **ON/STAND-BY** button , **LONG COFFEE** button  and the descaling warning lamp will all come on to a steady light .

*The acoustic signals will not be emitted if they have been turned OFF.



- 6** Press the **LONG COFFEE** button  to start the descaling cycle.



- !** If the **LONG COFFEE** button  is not pressed within 9 minutes after the acoustic signal has been emitted, the machine will go back to the “Stand-by” mode and the step **6** in the procedure shall be repeated, to start the cycle.

In case of power supply interruption, the machine will, upon the first power-on, resume the descaling procedure where it was interrupted: press the **LONG COFFEE** button  to restart **DESCALING**.

- 7** The machine will automatically activate the descaling process, after the heating cycle is over.

- i** During the descaling cycle, the **LONG COFFEE** button  will be **ON** and **blinking** and the descaling warning lamp  will be **ON** to a steady light

- !** During the descaling cycle, the machine will automatically perform intermittent supply cycles, to allow the container to be emptied.

- i** The descaling cycle can be temporarily interrupted by pressing either the **LONG COFFEE** button , **ON/STAND-BY** button . To start the cycle again, press the **LONG COFFEE** button .

- 8** The cycle will be temporarily interrupted when the fluid runs out in the machine tank.

- !** **DO NOT** top up the tank during this phase. You must allow the tank to empty completely.

- 9** Empty the container used to collect the solution.

- i** **ON/STAND-BY** button , **LONG COFFEE** button  and “No water” warning lamp  will be **ON** to a steady light. Descaling warning lamp  will be **ON** and **blinking**.

- 10** Remove the water tank, rinse and wash it accurately. Fill it with drinking fresh non-carbonated water up to the **MAX.** level.



- !** In case of power supply interruption, the machine will, upon the first power-on, resume the rinse procedure where it was interrupted: press the **LONG COFFEE** button  to restart **RINSING**.

- 11** Fit the tank back into place on the machine. Place a container with a capacity of at least 16.9 fl oz (0.5 L) under the supplying device.

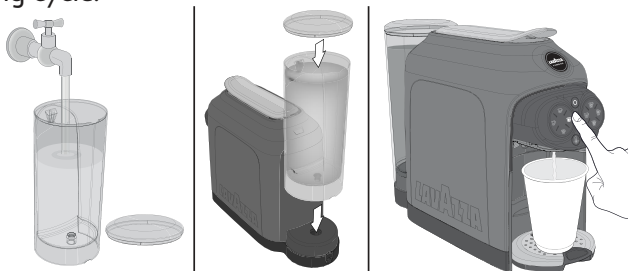
- 12** Press the **LONG COFFEE** button  to start the rinsing cycle.



- i** To end the rinse cycle, a minimum amount of water of **33.81 fl oz (1 litre) (approximately 1 full tank)** will have to be supplied.

In case of lack of water, the cycle will be temporarily interrupted, the machine will emit a prolonged acoustic signal  (if enabled) and the “No water” warning lamp  will come on to a steady light. Top up the tank and press the **LONG COFFEE** button  again to restart the rinse cycle.

- 13** At rinse end, the descaling warning lamp goes off, which confirms that the procedure has come to an end. Before using the machine, empty and thoroughly rinse the milk frothing jug and its cover, clean it using a soft moist cloth.

DESCALING AS REGARDS MACHINES WITH SERIAL NUMBER UNTIL 1947S001034762

i The machine serial number is shown below the barcode on the label put under the machine.

! Carefully read the descaling instructions.

Limescale normally builds up with extended use of the appliance; the machine needs descaling every 2 months and/or whenever a reduction in water flow is noticed. The descaling cycle will be requested by the machine through the switching-on of the special warning lamp available .

! Do not switch the machine off when the descaling cycle is under way. The machine must be monitored during the descaling cycle. The cycle will have, once it has been started, to be performed completely. Check there is no capsule inside the capsule containing compartment.

1 Remove and empty the water tank and remove the milk whipping jug.

! Do not drink the descaling solution and products dispensed until the completion of the cycle. Never use vinegar as a descaling solution.

i To decalcify the machine, It is recommended that the **LAVAZZA DESCALING** agent should be used.



2 Fill the tank with the **LAVAZZA DESCALING** agent 8.7fl oz (250 ml) and water 8.7fl oz (250 ml).

3 Fit the tank back into place on the machine.

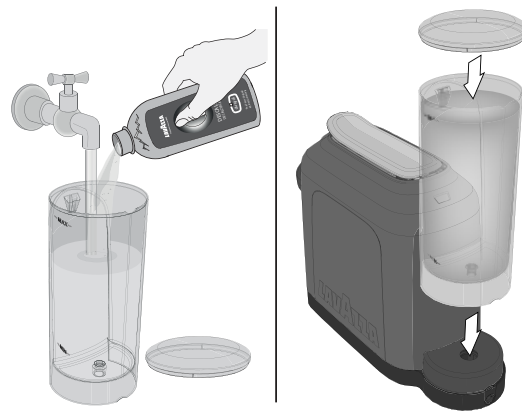
i Use a moist cloth to wipe off the squirts or drops, if any.



4 Place a container with a capacity of at least 16.9 fl oz (0.5 L) under the supplying device.

5 Keep, with the machine in the **STAND-BY** mode, the **ESPRESSO**  and **LONG ESPRESSO**  supply buttons simultaneously depressed over at least 3 seconds.





i The machine will emit a prolonged acoustic signal, then the **ON/STAND-BY** , **FREE DOSE**  and the descaling warning lamp will all come on to a steady light .

*The acoustic signals will not be emitted if they have been turned OFF.



- 6** Press the **FREE DOSE** button  to start the descaling cycle.



- !** If the **FREE DOSE** button  is not pressed within 9 minutes after the acoustic signal has been emitted, the machine will go back to the “Stand-by” mode and the step **6** in the procedure shall be repeated, to start the cycle.

In case of power supply interruption, the machine will, upon the first power-on, resume the descaling procedure where it was interrupted: press the **FREE DOSE** button  to restart **DESCALING**.

- 7** The machine will automatically activate the descaling process, after the heating cycle is over.

- i** During the descaling cycle, the **FREE DOSE** button  will be **ON** and **blinking** and the descaling warning lamp  will be **ON** to a steady light

- !** During the descaling cycle, the machine will automatically perform intermittent supply cycles, to allow the container to be emptied.

- i** The descaling cycle can be temporarily interrupted by pressing either the **FREE DOSE** button , **ON/STAND-BY** button . To start the cycle again, press the **FREE DOSE** button .

- 8** The cycle will be temporarily interrupted when the fluid runs out in the machine tank.

- !** **DO NOT** top up the tank during this phase. You must allow the tank to empty completely.

- 9** Empty the container used to collect the solution.

- i** **ON/STAND-BY** button , **FREE DOSE** button  and “No water” warning lamp  will be **ON** to a steady light. Descaling warning lamp  will be **ON** and **blinking**.

- 10** Remove the water tank, rinse and wash it accurately. Fill it with drinking fresh non-carbonated water up to the **MAX.** level.



- !** In case of power supply interruption, the machine will, upon the first power-on, resume the rinse procedure where it was interrupted: press the **FREE DOSE** button  to restart **RINSING**.

- 11** Fit the tank back into place on the machine. Place a container with a capacity of at least 16.9 fl oz (0.5 L) under the supplying device.

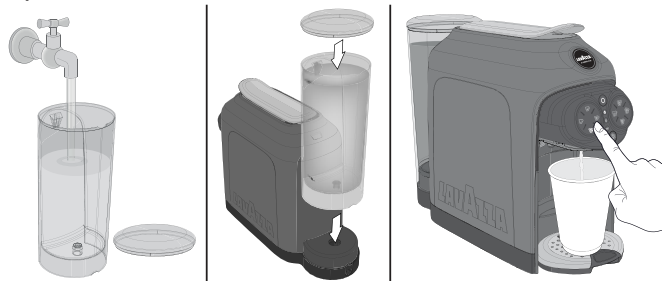
- 12** Press the **FREE DOSE** button  to start the rinsing cycle.







- i** To end the rinse cycle, a minimum amount of water of **33.81 fl oz (1 litre) (approximately 1 full tank)** will have to be supplied.

In case of lack of water, the cycle will be temporarily interrupted, the machine will emit a prolonged acoustic signal  (if enabled) and the “No water” warning lamp  will come on to a steady light. Top up the tank and press the **FREE DOSE** button  again to restart the rinse cycle.

- 13** At rinse end, the descaling warning lamp goes off, which confirms that the procedure has come to an end. Before using the machine, empty and thoroughly rinse the milk frothing jug and its cover, clean the machine using a soft moist cloth.

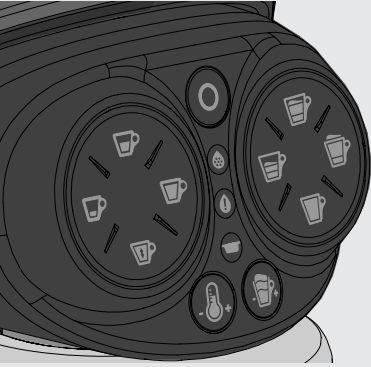
TROUBLESHOOTING

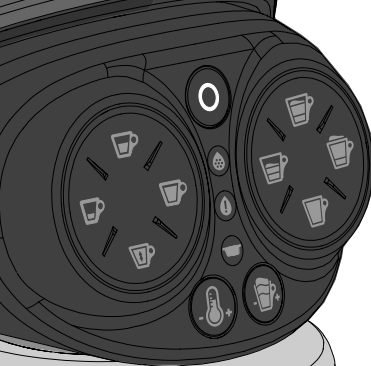
EN

Problem encountered	Possible causes	Solution
<p>Machine does not turn ON/STAND-BY  warning lamp OFF.</p> 	<ul style="list-style-type: none"> » Machine is not connected to the power source. » The machine is connect to power strip not working. » Power supply not available in the electric/household mains. 	<ul style="list-style-type: none"> » Connected the machine to the power source. » Connected the machine directly to the power source. » Connect another device to check the power supply. <p>IF THE PROBLEM REMAIN PLEASE CONTACT LAVAZZA CUSTOMER SERVICE.</p>
<p>The machine will not switch on after the ON/STAND-BY button  is pressed.</p> 	<ul style="list-style-type: none"> » Touch interface fails to respond. » Wrong simultaneous pressure of 2 buttons. 	<ul style="list-style-type: none"> » Verify that the interface surface and the user's hands are clean and dry. » Wait a few seconds, then press the ON/STAND-BY button  only. <p>IF THE PROBLEM REMAIN PLEASE CONTACT LAVAZZA CUSTOMER SERVICE.</p>
<p>Excessive heating time perceived (i.e. more than 40 seconds).</p>	<ul style="list-style-type: none"> » Machine storage at low temperatures (e.g.: cellar/garage). 	<ul style="list-style-type: none"> » Keep the machine in a suitable place over at least 1 hour. Then, plug the machine into the mains socket and try to switch it on. <p>IF THE PROBLEM REMAIN PLEASE CONTACT LAVAZZA CUSTOMER SERVICE.</p>

Problem encountered	Possible causes	Solution
The machine is very noisy.	<ul style="list-style-type: none"> » Machine not is on a flat and stable surface. » Power supply cable incorrectly positioned. » Movable parts not fitted properly. » No water in the tank. » Capsule not present 	<ul style="list-style-type: none"> » Check the surface. » Check the correct position of the cable into the base of the machine. » Fit the movable parts properly. » Top up the tank with fresh drinking water. » Insert Lavazza A MODO MIO capsule or compatible. <p>IF THE PROBLEM REMAIN PLEASE CONTACT LAVAZZA CUSTOMER SERVICE.</p>
Unit ready for use and failing to acknowledge the button press.	<ul style="list-style-type: none"> » Wrong button press/activation. » Used capsule collection tray not fitted. » Water circuit clogged with scale deposits. 	<ul style="list-style-type: none"> » Press one of the illuminated buttons with your fingertip, then check the availability of the acoustic signal (if activated) and the proper blinking of the selected icon. » Check the correct insertion of the tray, with the resulting alarm warning lamp switch-off. Check for correct supplying. <p>IF THE PROBLEM REMAIN PLEASE CONTACT LAVAZZA CUSTOMER SERVICE.</p>
The lever remains closed after the supply.	<ul style="list-style-type: none"> » Used capsule tray full. 	<ul style="list-style-type: none"> » Empty the tray and try to open the lever. <p>IF THE PROBLEM REMAIN PLEASE CONTACT LAVAZZA CUSTOMER SERVICE.</p>

TROUBLESHOOTING

EN

Problem encountered	Possible causes	Solution
<p>No supply (the machine is switched on, yet it supplies no coffee or water).</p>	<ul style="list-style-type: none"> » No water in the tank. » Tank not inserted correctly. » Capsule loading lever lifted or not lowered correctly. » No water flow in the hydraulic circuit (no activation). » Capsule not compatible. » Presence of limescale. 	<ul style="list-style-type: none"> » Top the tank up with drinking fresh water, then check for correct supplying. » Correctly fit the tank in, then check for correct supplying. » Lower the capsule loading lever up to the stop, then check for correct supplying. » Disconnect the power cord, wait 10 seconds, then connect the power cord again. Switch the machine on and wait for the heating cycle to be over. Check for correct supplying (the machine will automatically make attempts at filling the hydraulic circuit). » Try again by using another capsule from a different package. » Perform the descaling procedure by means of the Lavazza descaling agent. <p>IF THE PROBLEM REMAIN PLEASE CONTACT LAVAZZA CUSTOMER SERVICE.</p>
<p>Water leaks in the coffee machine.</p>	<ul style="list-style-type: none"> » Tank damaged. » Spent capsule drawer filled. » Capsule stuck. » Capsule not compatible. 	<ul style="list-style-type: none"> » Check for leaks in the tank keeping it separate from the machine. » Empty the spent capsule drawer. » Open and close the lever to drop the capsule. Remove and empty the capsule collection tray. » Use suitable capsules (i.e. Lavazza A MODO MIO capsules or any compatible capsule). <p>IF THE PROBLEM REMAIN PLEASE CONTACT LAVAZZA CUSTOMER SERVICE.</p>

Problem encountered	Possible causes	Solution
ON/STANDBY button  blinking red.	» Inadequate machine storing conditions / Temporary lock.	» Unplug the machine from the power socket and allow it to rest at room temperature enough time (max. 1 hour). Plug the machine in again, then press the switch-on button (make one attempt only). IF THE PROBLEM REMAIN PLEASE CONTACT LAVAZZA CUSTOMER SERVICE.
The loading lever does not reach the supply position or requires an excessive closing effort.	» Spent capsule drawer filled. » Capsule stuck.	» Empty the tray and make an attempt at closing the lever. » Open and close the lever to drop the capsule. IF THE PROBLEM REMAIN PLEASE CONTACT LAVAZZA CUSTOMER SERVICE.
Coffee is dispensed too fast and, therefore, it is not so creamy.	» A previously used capsule is used. » Capsule not present. » Capsule not compatible.	» Use a new capsule. » Insert the capsule. » Try again by using another capsule from a different package. IF THE PROBLEM REMAIN PLEASE CONTACT LAVAZZA CUSTOMER SERVICE.
The coffee is cold.	» Slow supplying, hydraulic circuit clogged with limescale.	» Perform the descaling procedure by means of the Lavazza descaling agent. IF THE PROBLEM REMAIN PLEASE CONTACT LAVAZZA CUSTOMER SERVICE.

TROUBLESHOOTING

EN





Problem encountered	Possible causes	Solution
The machine emits no sound	» Acoustic signal OFF.	<p>» Set the machine to the stand-by mode, then simultaneously keep the “Espresso coffee” and “Weak coffee” buttons depressed over at least 5 seconds (refer to the “GETTING THE MACHINE READY” section)</p> <p>IF THE PROBLEM REMAIN PLEASE CONTACT LAVAZZA CUSTOMER SERVICE.</p>
Coffee flows out slowly drop by drop.	<p>» Capsule not compatible.</p> <p>» An inadequate pod has been used.</p> <p>» Supplying device clogged.</p> <p>» Hydraulic circuit clogged with limescale.</p>	<p>» Try again by using another capsule from a different package.</p> <p>» Remove the used capsule and use a new capsule.</p> <p>» Clean the coffee dispensing spout (see MAINTENANCE AND CLEANING).</p> <p>» Perform the descaling procedure by means of the Lavazza descaling agent.</p> <p>IF THE PROBLEM REMAIN PLEASE CONTACT LAVAZZA CUSTOMER SERVICE.</p>
The milk-based beverage warning lights are OFF and the buttons won't work.	<p>» Milk jug missing or inserted wrongly.</p> <p>» Milk cover positioned with the nozzles facing the handle.</p>	<p>» Insert the milk jug. The milk preparation warning lights will be turned on if the jug is inserted correctly</p> <p>» Turn the milk cover so that the nozzle will face the direction opposite the handle. The milk preparation warning lights will be turned on if the jug is inserted correctly.</p> <p>IF THE PROBLEM REMAIN PLEASE CONTACT LAVAZZA CUSTOMER SERVICE.</p>

Problem encountered	Possible causes	Solution
Milk does not foam.	<ul style="list-style-type: none"> » Milk unsuitable for use. » Too hot milk temperature. » Beater coil not fitted into place. » Water circuit clogged with scale deposits. 	<ul style="list-style-type: none"> » It is recommended that whole milk (pasteurized or UHT treated) and/or cold skimmed milk from the fridge 39°F-46°F (4-8°C) should be used. » Use milk at the fridge temperature (i.e. ranging between 4°C and 8°C). » Make sure that the beater coil has been fitted into place correctly. » Perform the descaling procedure by means of the Lavazza descaling agent. <p>IF THE PROBLEM REMAIN PLEASE CONTACT LAVAZZA CUSTOMER SERVICE.</p>
The milk-based beverage temperature is too hot.	<ul style="list-style-type: none"> » Insufficient amount of milk fed with respect to the selected / desired amount. 	<ul style="list-style-type: none"> » Add more milk by following the indications of the icons on the milk jug. <p>IF THE PROBLEM REMAIN PLEASE CONTACT LAVAZZA CUSTOMER SERVICE.</p>
The milk-based beverage temperature is too cold.	<ul style="list-style-type: none"> » Excessive amount of milk fed with respect to the selected / desired amount. » Water circuit clogged with scale deposits. 	<ul style="list-style-type: none"> » Decrease the amount of milk by following the indications of the icons on the milk jug. » Perform the descaling procedure by means of the Lavazza descaling agent. <p>IF THE PROBLEM REMAIN PLEASE CONTACT LAVAZZA CUSTOMER SERVICE.</p>
Noisy operation of the cappuccino maker during the preparation with milk.	<ul style="list-style-type: none"> » Milk whipping beater incorrectly fitted into place. 	<ul style="list-style-type: none"> » Fit the milk whipping beater into the correct position, as shown in the Manual (see page 71). <p>IF THE PROBLEM REMAIN PLEASE CONTACT LAVAZZA CUSTOMER SERVICE.</p>

TROUBLESHOOTING

EN

Problem encountered	Possible causes	Solution
No coffee available for preparing the cappuccinos and the milk with coffee	<ul style="list-style-type: none"> » Coffee capsule missing. » Previous coffee capsule not discharged. » Early removal of the milk jug. 	<ul style="list-style-type: none"> » Insert a coffee capsule and prepare the new desired beverage by eliminating the previous one. » Discharge the used capsule, insert a new one and prepare the new desired beverage by eliminating the previous one. » Wait for the acoustic signal  at the end of preparing the selected beverage. <p>IF THE PROBLEM REMAIN PLEASE CONTACT LAVAZZA CUSTOMER SERVICE.</p>
Milk spilling out of the jug	<ul style="list-style-type: none"> » Milk jug broken. » Excessive milk jug filling (above the upper notch / icon). » Insufficient milk jug filling (below the selected notch / icon). » Selection of the same beverage used for the previous preparation. 	<ul style="list-style-type: none"> » Check the integrity of the milk jug. In case of breakage, CONTACT THE LAVAZZA CUSTOMER SERVICE. » Fill with the correct amount, as shown by the icons on the jug. » Fill with the correct amount, as shown by the icons on the jug. » Prepare the new desired beverage by eliminating the previous one and by applying one cycle ONLY. <p>IF THE PROBLEM REMAIN PLEASE CONTACT LAVAZZA CUSTOMER SERVICE.</p>

Problem encountered	Possible causes	Solution
COLD WHIPPED MILK  beverage preparation hot	» Wrong access procedure for the COLD WHIPPED MILK  beverage.	» Repeat the access procedure by keeping the "Temperature boost" button depressed until the icon turns BLUE  (as shown in page 67 of the Manual). IF THE PROBLEM REMAIN PLEASE CONTACT LAVAZZA CUSTOMER SERVICE.
ON/STANDBY button  red warning light with acoustic signal  emitted when preparing a milk-based beverage.	» Products other than milk (e.g. powders) have been used.	Use only milk to prepare the beverages supplied by the machine. IF THE PROBLEM REMAIN PLEASE CONTACT LAVAZZA CUSTOMER SERVICE.

Contact Lavazza Customer Service for any problem or failure not included in the above list.

TECHNICAL SPECIFICATIONS

- Power supply: 220-240V / 50-60Hz
- Nominal power: 1500W
- Dimensions:

Height	Width	Depth
280 mm	145 mm	380 mm
11.02 in	5.70 in	14.96 in
- Weight: 4,5 kg (8,81 lb)
- Water tank removable type: 1,1 L (38,71 oz)
- Housing materials: Thermoplastic
- Cable Length: 0,8 m (31.49 in)