

Gear Pro



ACTIV



Model:

GDV288

The 'Gear Pro Activ' App



Appearance and Buttons

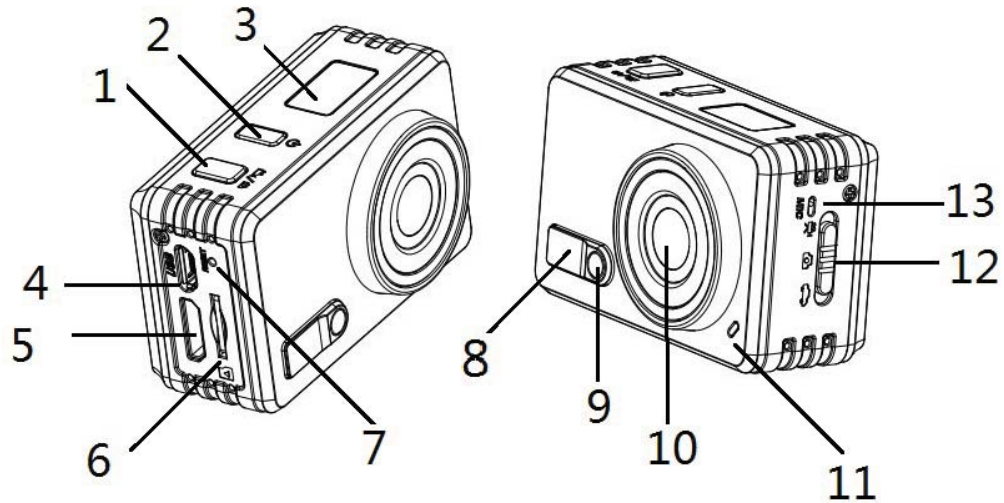

1. Shutter Button
2. Power Button
3. LCD Display
4. Micro USB Port
5. Mini HDMI Port
6. Micro SD Card Slot
7. Reset Button
8. Wi-Fi Switch
9. Wi-Fi Status Indicator
10. Lens
11. Charging Indicator
12. Mode Selector Switch
13. Microphone

LCD Display Illustration

Turn on the camera, the LCD will display the following:

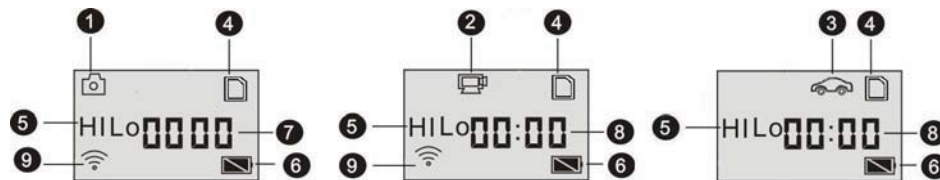

1. Camera mode
2. Video recording mode
3. Vehicle-mounted mode
4. SD card icon (display when loaded)
5. Resolution icons:
 - ❖ In camera mode:
 - HI** stands for 8 Mega Pixels (3264x2448),
 - LO** stands for 5 Mega Pixels (2592x1944),
 - ❖ In video recording and vehicle-mounted modes:
 - HI** stands for 1080p (1920x1080) @ 30fps
 - LO** stands for 720P (1280x720) @ 60fps
6. Battery icon: current battery level of the camera
7. Counter, displays up to 9999.
8. Timer, displays minutes and seconds.
9. Wi-Fi icon (display when enabled)

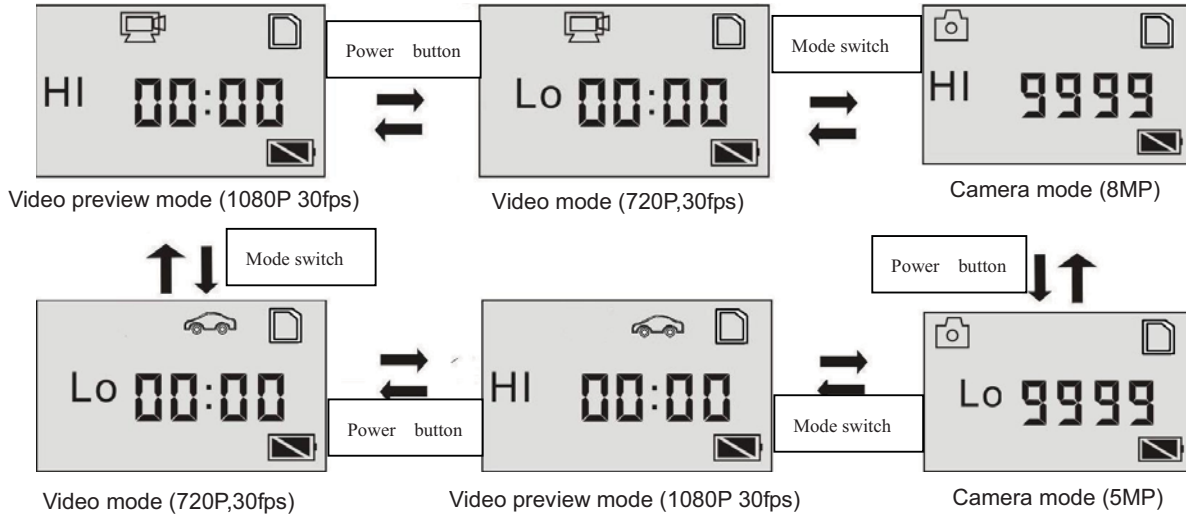

Working Mode Flow Chart

After powering on the camera, you can adjust settings by pressing the Power Button and sliding the Mode Selector Switch on the side.







Sliding the Mode Selector Switch, located on the side panel, changes the Gear Pro from camera, video recording and vehicle mounted modes. Simply slide the switch to choose your desired mode.

The Recording Mode icons appear as the following:

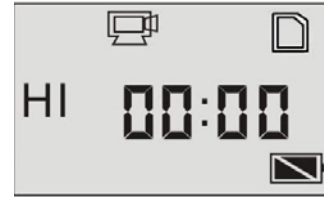
	video recording	HI stands for 1080p (1920x1080) @ 30fps
		LO stands for 720p (1280x720) @ 60fps
	picture taking	HI stands for 8MP (3264 x 2448) resolution
		LO stands for 5MP (2592 x 1944) resolution
	vehicle-mounted	HI stands for 1080p (1920x1080) @ 30fps
		LO stands for 720p (1280x720) @ 60fps

Default Settings and Display



	Video recording mode icon	Gear Pro is in video recording mode.
HI	Video resolution	FHD: 1080p @ 30fps
00:00	Recording time	Time display stands for 00 minutes then 00 seconds
	SD card icon	Displayed when SD card is inserted, otherwise no display
	Battery level	Battery is full
	Wi-Fi icon	Displayed when activated

In video recording and vehicle-mounted modes, press the Shutter button to start recording (The indicator light will blink on the front of the camera meaning the Gear Pro is recording video). The LCD display will also activate its timer showing you the length of your video recording. Press the shutter again to stop recording.

In camera mode, press the Shutter button to take photos. The LCD display will also generate a number. This number, according to the size of your inserted Micro SD Memory Card, indicates how many photos are remaining and available to take. (Until the capacity of your memory card is depleted).



Recording Modes



Video recording mode

To record a video, please check whether the Gear Pro is in Video mode.

(the icon  is played on the screen)

Start recording: Press and release the  button, the icon  will appear on the LCD display.

Stop recording: Press and release the  button, the blue indicator will stop blinking, meaning the recording is stopped.

When the SD card is full, or the battery runs out, the recording will stop automatically, and the recorded video will be saved before the Gear Pro powers off.



Camera mode

To take a photo, please check whether the Gear Pro is in Camera mode.



(the icon  is played on the screen)

Press and release the  button, The blue indicator will flash, meaning a photo is taken.

Vehicle-mounted mode

Please check whether the Gear Pro is in Vehicle-mounted mode.

(the icon  is played on the screen)

Start recording: Press and release the  button, the icon  and  will appear on the LCD display.

Stop recording: Press and release the  button, and the blue indicator will stop blinking, meaning the recording is stopped.

***Please note, while recording in Vehicle-mounted mode, the Gear Pro will save a segment for recording every 3 minutes, then start to record the next segment of video. When the storage card is full, the earliest segment of video will be deleted to release the corresponding space for continuous recording.**

Micro SD Card

Be sure to have a compatible Micro SD Memory Card:

High speed card at least Class 4 is recommended

1. Insert a micro SD or micro SDHC card, as shown below:

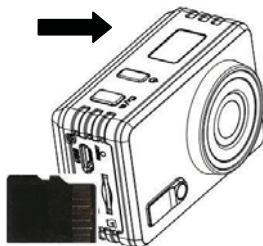

Turn off the Gear Pro before inserting or removing the card.

Charging

The Gear Pro comes with built-in rechargeable lithium battery.

When the Gear Pro is off, connect it to your Mac or PC via USB cable to charge the battery.

During charging, the battery indicator light will blink on.

Note: When the Gear Pro is on, connecting it to your computer will not charge the camera.

Basic Operation

Turn on/off

To power on: press and hold  the button for about 3 seconds, until the LCD displays “ON”.

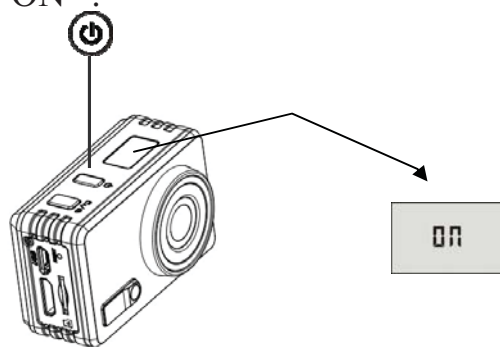

To power off: press and hold the  button for about 3 seconds, LCD displays “OFF” .

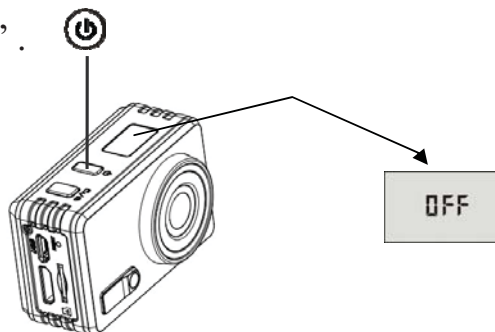

Note: The Gear Pro will turn off automatically if idle for 5 minutes

Wi-Fi Connection

Enable/disable Wi-Fi

The Wi-Fi is disabled by default. Press the Wi-Fi button on the front of the camera to enable it. The orange indicator will blink and the Wi-Fi icon will display on LCD screen. After a few seconds, the Wi-Fi button will remain orange, signaling ready for use with the app. Press the Wi-Fi button again to power off.

Wi-Fi icon display

Please see the LCD display below after activating Wi-Fi:

In video recording modes:



Wi-Fi is disabled by default

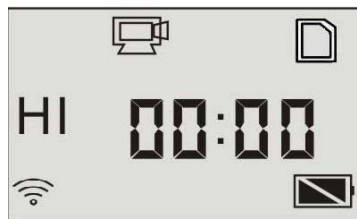

When Wi-Fi is enabled,
the Wi-Fi icon is displayed

In camera mode:



***In order to save power, Wi-Fi will be automatically disabled if no terminal is connected after 30 seconds.**

The 'Gear Pro Activ' Downloadable Application

Supports Android and iOS

Download and Install

Search for "Gear Pro Activ" in the Google Play or Apple App Store

Once installed, find the app icon on your Smartphone or Tablet.

Be sure to have a successful Wi-Fi connection.

Enable Wi-Fi on your device. The Gear Pro wireless AP signal will be labeled as 'Gear Pro Activ'

Note: If you are prompted for a password, enter '1234567890'

'Gear Pro Activ' Application Interface (Android)



1. Video resolution
2. White balance
3. Setup (enter setup menu)
4. Enter Playback mode
5. Shutter button
6. Photo mode
7. Video mode
8. Wi-Fi signal icon
9. DV battery icon

'Gear Pro Activ' Application Interface (iOS)

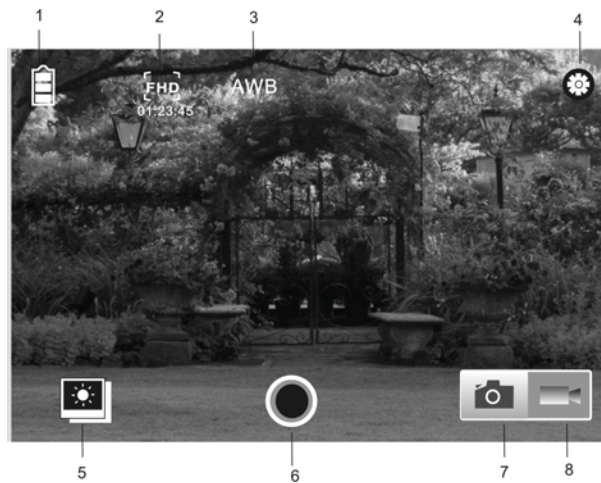

1. battery icon
2. Video resolution
3. White balance
4. Setup (enter setup menu)
5. Enter Playback mode
6. Shutter button
7. Photo mode
8. Video mode

The 'Gear Pro Activ' App allows you to take control of the camera right from your device. You'll be able to snap pictures and record video with the press of a button. Once connected, you'll also be able to preview images, and even download images and video to your device. Take control and make adjustment settings like continuous shooting, white balance, frequency, choose video resolution and more.

***Please note, according to your device's operating version and codec packages, you may not be able to preview video files or hear audio from these files. However you can still download and transfer these files to a compatible device.**

HDTV - HDMI Connection

Connect the Gear Pro to an HDTV via HDMI cable (not included).

If you need to transfer the image and audio to an HDTV for playback, insert the Com end of the HDMI cable to the Gear Pro, and the other end (output) to the HD input of the HDTV, as shown in the following figure:

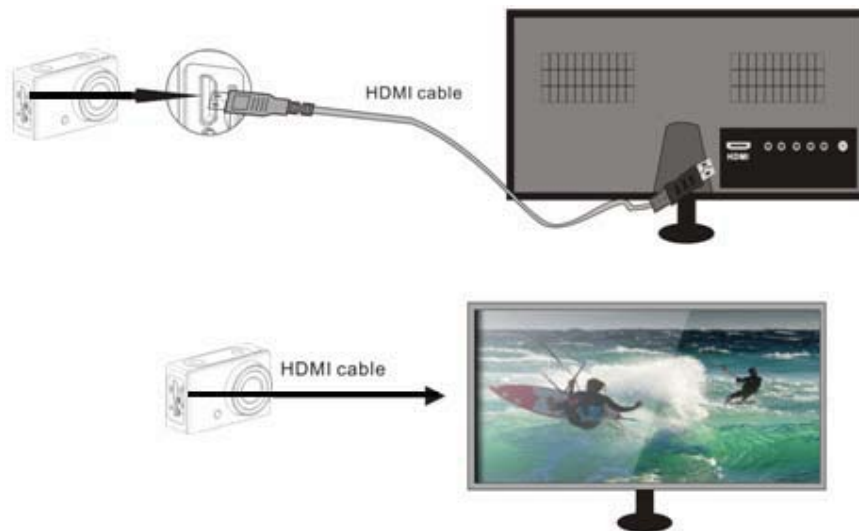



Note: Before connecting or removing the HDMI cable, please stop video recording, playback and disconnect Wi-Fi first.

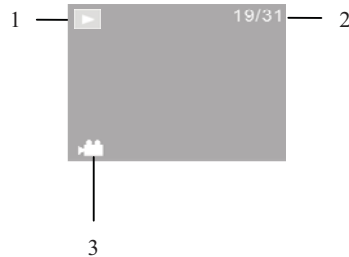

HDTV - HDMI Connection

When your HDTV is connected, the Gear Pro enters Playback mode, the Gear Pro's LCD is displayed as below:



S/N	Icon name	Description
1	Playback mode	Indication of playback mode
2	File number	There are 31 files and you are viewing the 19 th one
3	Video icon	The file is a video

In Playback mode, press the Power button  to switch to the next photo or video. When a video file is selected, press the Shutter button  to play it, and press the Shutter button again to stop playing.

In Playback mode, press and hold the Shutter button , a prompt of deleting the file or formatting will appear. Press the Wi-Fi button to switch between deleting or formatting. Then Press the Power button  to select Yes or No, and press the Shutter button  to confirm and exit.

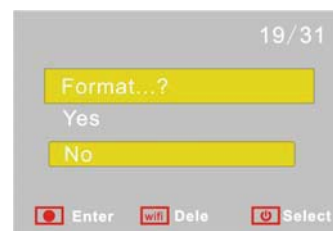
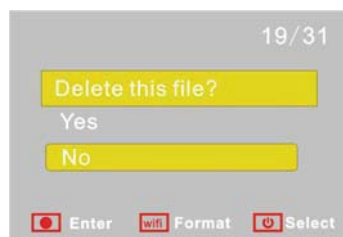

Connecting to PC

Turn on the Gear Pro and connect it to the USB port of your computer.

The Gear Pro will enter U-disk mode and the LCD will display:

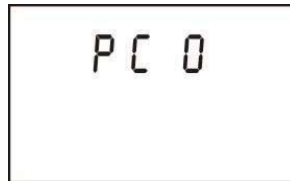

This is also known as Preview Mode.

Now you can view the photos or videos taken by DV on PC.

While in this Preview Mode (PCO mode), press the Shutter button  to switch to Web Cam Mode (PCC mode), and the LCD will display:

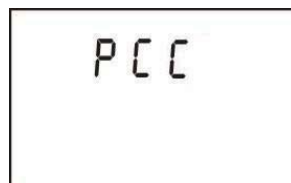

Now you can start the web cam through your computer's compatible software and applications. To return to the Preview Mode (PCO mode), press the  button again

***Note: Necessary drivers may be required for proper operation of the Web Cam Mode feature. However, drivers are not required for web cam mode (PCC mode) on Windows XP(SP3) version or above.**