

Frymaster®

We Fit the Way You Fry™

FQE80U/FQE100U FilterQuick™

easyTouch®

Electric Fryer

Installation, Operation and Maintenance Manual

This manual is updated as new information and models are released. Visit our website for the latest manual.



FOR YOUR SAFETY

Do Not Store or use gasoline or other flammable vapors and liquids in the vicinity of this or any other appliance.

⚠ CAUTION

READ THE INSTRUCTIONS BEFORE USING THE FRYER.

Keep these instructions for future reference.



Part Number: FRY_IOM_8197782 07/2024

Original Instructions



WELBILT®

NOTICE

IF, DURING THE WARRANTY PERIOD, THE CUSTOMER USES A PART FOR THIS FRYMASTER DEAN EQUIPMENT OTHER THAN AN **UNMODIFIED** NEW OR RECYCLED PART PURCHASED DIRECTLY FROM FRYMASTER DEAN, OR ANY OF ITS FACTORY AUTHORIZED SERVICERS, AND/OR THE PART BEING USED IS MODIFIED FROM ITS ORIGINAL CONFIGURATION, THIS WARRANTY WILL BE VOID. FURTHER, FRYMASTER DEAN AND ITS AFFILIATES WILL NOT BE LIABLE FOR ANY CLAIMS, DAMAGES OR EXPENSES INCURRED BY THE CUSTOMER WHICH ARISE DIRECTLY OR INDIRECTLY, IN WHOLE OR IN PART, DUE TO THE INSTALLATION OF ANY MODIFIED PART AND/OR PART RECEIVED FROM AN UNAUTHORIZED SERVICER.

NOTICE

This appliance is intended for professional use only and is to be operated by qualified personnel only. A Frymaster Authorized Servicer (FAS) or other qualified professional should perform installation, maintenance, and repairs. Installation, maintenance, or repairs by unqualified personnel may void the manufacturer's warranty. See Chapter 1 of this manual for definitions of qualified personnel.

NOTICE

This equipment must be installed in accordance with the appropriate national and local codes of the country and/or region in which the appliance is installed. See NATIONAL CODE REQUIREMENTS in Chapter 2 of this manual for specifics.

NOTICE TO U.S. CUSTOMERS

This equipment is to be installed in compliance with the basic plumbing code of the Building Officials and Code Administrators International, Inc. (BOCA) and the Food Service Sanitation Manual of the U.S. Food and Drug Administration.

 WARNING

Improper installation, adjustment, maintenance or service, and unauthorized alterations or modifications can cause property damage, injury, or death. Read the installation, operating, and service instructions thoroughly before installing or servicing this equipment.

 FOR YOUR SAFETY

Do not store or use gasoline or other flammable liquids or vapors in the vicinity of this or any other appliance.

NOTICE TO OWNERS OF UNITS EQUIPPED WITH TOUCH SCREEN CONTROLLERS

U.S.

This device complies with Part 15 of the FCC rules. Operation is subject to the following two conditions: 1) This device may not cause harmful interference, and 2) This device must accept any interference received, including interference that may cause undesired operation. While this device is a verified Class A device, it has been shown to meet the Class B limits.

CANADA

This digital apparatus does not exceed the Class A or B limits for radio noise emissions as set out by the ICES-003 standard of the Canadian Department of Communications.

Cet appareil numérique n'émet pas de bruits radioélectriques dépassant les limites de classe A et B prescrites dans la norme NMB-003 édictée par le Ministre des Communications du Canada.

 DANGER

When installed, this appliance must be electrically grounded in accordance with local codes, or in the absence of local codes, with the National Electrical Code, ANSI/NFPA 70, the Canadian Electrical Code, CSA C22.2, or the appropriate national code of the country in which installed.

 WARNING

The appliance must be installed and used in such a way that any water cannot contact the fat or oil.

NOTICE

This appliance is intended to be used for commercial applications, for example in kitchens of restaurants, canteens, hospitals and in commercial enterprises such as bakeries, butcheries, etc., but not for continuous mass production of food.

⚠ DANGER

The front ledge of this appliance is not a step! Do not stand on the appliance. Serious injury can result from slips or contact with the hot oil.

NOTICE

Drawings and photos used in this manual are intended to illustrate operational, cleaning and technical procedures and may not conform to onsite management operational procedures.

⚠ DANGER

The crumb tray in fryers equipped with a filter system must be emptied into a fireproof container at the end of frying operations each day. Some food particles can spontaneously combust if left soaking in certain shortening material.

⚠ WARNING

Do not bang fry baskets or other utensils on the fryer's joiner strip. The strip is present to seal the joint between the fry vessels. Banging fry baskets on the strip to dislodge shortening will distort the strip, adversely affecting its fit. It is designed for a tight fit and should only be removed for cleaning.

⚠ DANGER

Adequate means must be provided to limit the movement of this appliance without depending on or transmitting stress to the electrical conduit. A restraint kit is provided with the fryer. If the restraint kit is missing contact your local KES.

⚠ DANGER

This fryer has a power cord (three-phase) for each frypot. Prior to movement, testing, maintenance and any repair on your Frymaster fryer; disconnect ALL electrical power cords from the electrical power supply.

⚠ DANGER

Keep all items out of drains. Closing actuators may cause damage or injury.

⚠ WARNING

This appliance is not intended for use by children under the age of 16 or persons with reduced physical, sensory or mental capabilities, or lack of experience and knowledge, unless they have been given supervision concerning use of the appliance by a person responsible for their safety. Do not allow children to play with this appliance.

⚠ DANGER

This appliance must be connected to a power supply having the same voltage and phase as specified on the rating plate located on the inside of the appliance door.

⚠ WARNING ⚠

Use caution and wear appropriate safety equipment to avoid contact with hot oil or surfaces that may cause severe burns or injury.

 **DANGER**

Do not spray aerosols in the vicinity of this appliance while it is in operation.

 **DANGER**

No structural material on the fryer should be altered or removed to accommodate placement of the fryer under a hood. Questions? Call the Frymaster Dean Service Hotline at 1-800-551-8633.

 **WARNING**

NEVER drain boil out or cleaning solution into a shortening disposal unit (SDU), a built-in filtration unit, a portable filter unit. These units are not intended for this purpose and will be damaged by the solution and void the warranty.

 **DANGER**

Prior to movement, testing, maintenance and any repair on your Frymaster fryer; disconnect ALL electrical power cords from the electrical power supply.

NOTICE

No warranty is provided for any Frymaster fryer used in a mobile or marine installation or concession. Warranty protection is only offered for fryers installed in accordance with the procedures described in this manual. Mobile, marine or concession conditions of this fryer should be avoided to ensure optimum performance.

 **WARNING**

Do not block the area around the base or under the fryers.

 **WARNING**

This equipment is intended for indoor use only. Do not install or operate this equipment in outdoor areas.

 **WARNING**

Do not use water jets to clean this equipment.

 **WARNING**

If the electrical power supply cord is damaged, it must be replaced by a Frymaster Factory Authorized Servicer or a similarly qualified person in order to avoid a hazard.

 **WARNING**

All wiring connections for this appliance must be made in accordance with the wiring diagram(s) furnished with the appliance. Refer to the wiring diagram(s) supplied with the fryer when installing or servicing this equipment.

 **WARNING**

Do not operate this equipment unless all covers and access panels are in place and properly secured.

 **DANGER**

Building codes prohibit a fryer with its open tank of hot oil being installed beside an open flame of any type, including those of broilers and ranges.

⚠ DANGER

Under all circumstances, oil must be removed from the fryer before attempting to move it to avoid spills, falls, and severe burns. Never attempt to transfer hot oil from one container to another. Fryers may tip and cause personal injury if not secured in a stationary position.

⚠ DANGER

Never operate the appliance with an empty frypot. The frypot must be filled to the fill line with water or cooking oil before energizing the elements. Failure to do so will result in irreparable damage to the elements and may cause a fire.

⚠ NOTICE

If this equipment is wired directly into the electrical power supply, a means for disconnection from the supply having a contact separation of at least 3-mm in all poles must be incorporated in the fixed wiring.

⚠ NOTICE

This equipment must be positioned so that the plug is accessible unless other means for disconnection from the power supply (e.g., a circuit breaker) is provided.

⚠ NOTICE

If this appliance is permanently connected to fixed wiring, it must be connected by means of copper wires having a temperature rating of not less than 167°F (75°C).

⚠ DANGER

NEVER set a complete block of solid shortening on top of heating elements. To do so will damage the elements and increase the potential for flash-point shortening temperatures and subsequent fire.

⚠ WARNING

Operation, installation, and servicing of this product may expose you to chemicals/products including [Bisphenol A (BPA), glass wool or ceramic fibers, and crystalline silica], which is [are] known to the State of California to cause cancer, birth defects or other reproductive harm. For more information go to www.P65Warnings.ca.gov.

⚠ WARNING

Do not leave the fryer unattended during use.

⚠ WARNING

Use caution when dropping wet food or water into the hot oil. It may cause spattering of the oil, which may cause severe burns

⚠ WARNING

Do not overfill the frypot to avoid overflow of hot oil that may cause severe burns, slipping and falling.

 **WARNING**

Use caution and wear appropriate safety equipment when adding oil to the fryer, to prevent splashing of hot oil, which may cause severe burns.

 **WARNING**

Use caution when dropping large amounts of food into the hot oil. It may cause large amounts of foaming, which can overflow and may cause burns.

 **WARNING**

Opening the drain valve will lead to the outflow of the hot contents of the fryer that can cause injury.

 **WARNING**

The OQS (Oil Quality Sensor) may be damaged by the following:

1. Incorrect assembly of the filter pan allowing Magnesol or other filter powders under the filter paper.
 2. Failure to use filter paper or pads.
 3. Torn filter paper or pads.
 4. Pumping water, boil out solution or other cleaners through the OQS sensor.
 5. Using high pressure to clear the sensor.
- Failure to follow these guidelines may result in high replacement costs and void the warranty.

Frymaster[®]

FQE80U/FQE100U FilterQuick™ easyTouch® Series Electric Fryers Installation and Operation Manual

TABLE OF CONTENTS

CHAPTER 1: Introduction

| | | |
|-----|--|-----|
| 1.1 | General..... | 1-1 |
| 1.2 | Safety Information | 1-1 |
| 1.3 | Controller Information | 1-2 |
| 1.4 | European Community (CE) Specific Information | 1-2 |
| 1.5 | Installation, Operating, and Service Personnel | 1-2 |
| 1.6 | Definitions | 1-3 |
| 1.7 | Shipping Damage Claim Procedure..... | 1-3 |
| 1.8 | Reading Model Numbers..... | 1-4 |
| 1.9 | Service Information..... | 1-4 |

CHAPTER 2: Installation Instructions

| | | |
|-------|---|-----|
| 2.1 | General Installation Requirements..... | 2-1 |
| 2.1.1 | Clearance and Ventilation | 2-2 |
| 2.1.2 | Electrical Grounding Requirements | 2-2 |
| 2.1.3 | Australian Requirements..... | 2-2 |
| 2.2 | Power Requirements | 2-3 |
| 2.3 | Positioning the Fryer..... | 2-4 |

CHAPTER 3: Operating Instructions

| | | |
|-----|---|-----|
| 3.1 | Equipment Setup and Shutdown Procedures | 3-2 |
| 3.2 | Operation..... | 3-3 |

CHAPTER 4: Filtration Instructions

| | | |
|---------|---|------|
| 4.1 | Introduction..... | 4-1 |
| 4.2 | Preparing Filtration System for Use with Filter Paper or Filter Pad | 4-1 |
| 4.3 | Preparing Filtration System for Use with Filter Leaf Envelope Assembly..... | 4-3 |
| 4.3.1 | Disassembly and Reassembly of the Leaf Screen Filter Assembly | 4-4 |
| 4.3.2 | Preparing the Filtration System for MasterFil Envelope Assy. | 4-4 |
| 4.3.2.1 | Disassembly of the MasterFil Filter Assembly. | 4-8 |
| 4.3.2.2 | Reassembly of the MasterFil Filter Assembly. | 4-9 |
| 4.4 | Daily Topping Off (If Applicable) | 4-10 |

CHAPTER 5: Preventive Maintenance

| | | |
|-------|--|-----|
| 5.1 | Cleaning the Fryer | 5-1 |
| 5.2 | Daily Checks and Service | 5-1 |
| 5.2.1 | Inspect Fryer and Accessories for Damage | 5-1 |
| 5.2.2 | Clean Inside and Outside Fryer Cabinet | 5-1 |
| 5.2.3 | Clean Built-In Filtration System..... | 5-1 |
| 5.2.4 | Clean Filter Pan, Detachable Parts and Accessories | 5-2 |
| 5.2.5 | Clean Around AIF Sensors..... | 5-2 |

| | | |
|--|---|-----|
| 5.2.6 | Clean Basket Lift Rods | 5-2 |
| 5.3 | Weekly Checks and Service | 5-2 |
| 5.3.1 | Clean Behind Fryers..... | 5-2 |
| 5.4 | Monthly Checks and Service | 5-2 |
| 5.4.1 | Drain, Clean Frypot and Heating Elements..... | 5-2 |
| 5.4.2 | Deep Cleaning (Boiling Out/Cold Clean) the Frypot..... | 5-3 |
| 5.4.3 | Pre-Filter Maintenance | 5-4 |
| 5.4.4 | Check FilterQuick™ easyTouch® Controller Setpoint Accuracy..... | 5-4 |
| 5.5 | Quarterly Checks and Service | 5-4 |
| 5.5.1 | Replace O-rings | 5-4 |
| 5.6 | Annual/Periodic System Inspection..... | 5-4 |
| 5.6.1 | Fryer | 5-4 |
| 5.6.2 | Built-In Filtration System | 5-5 |
| CHAPTER 6: Operator Troubleshooting | | |
| 6.1 | Introduction..... | 6-1 |
| 6.2 | Troubleshooting..... | 6-2 |
| 6.2.1 | Controller and Heating Problems..... | 6-2 |
| 6.2.2 | Error Message and Display Problems | 6-3 |
| 6.2.3 | Filtration Problems | 6-4 |
| 6.2.3.1 | Incomplete Filtration..... | 6-5 |
| 6.2.3.2 | Clogged Drain Error | 6-6 |
| 6.2.3.3 | Filter Busy | 6-6 |
| 6.2.4 | Basket Lift Problems..... | 6-6 |
| 6.2.5 | Error Log Codes..... | 6-7 |
| 6.2.6 | OQS (Oil Quality Sensor) | 6-9 |

FQE80U/FQE100U FILTERQUICK™ easyTouch® SERIES ELECTRIC FRYER

CHAPTER 1: INTRODUCTION

NOTE: The Frymaster FQE80U/FQE100U FilterQuick™ easyTouch® fryer requires a start-up, demonstration and training before normal restaurant operations can begin.

1.1 General

Read the instructions in this manual thoroughly before attempting to operate this equipment. This manual covers all configurations of FQE80U/FQE100U FilterQuick™ easyTouch® electric models. The fryers in this model family have most parts in common, and when discussed as a group, will be referred to as FQE80U/FQE100U FilterQuick™ easyTouch® electric fryers.

The FQE80U/FQE100U FilterQuick™ easyTouch® electric fryers feature an open frypot with rotating elements, automatic oil top off and semi-automatic fingertip filtration unit. The Euro-Look design incorporates a rounded topcap and a large round drain, which ensures that fries and other debris, will be washed into the filter pan. The FQE80U/FQE100U FilterQuick™ easyTouch® electric fryers are controlled with a FilterQuick™ controller. Fryers in this series come in full arrangements and can be purchased as single units or in batteries of up to four fryers.

1.2 Safety Information

Before attempting to operate your unit, read the instructions in this manual thoroughly.

Throughout this manual, you will find notations enclosed in double-bordered boxes similar to the one below.

 **DANGER**

Hot oil causes severe burns. Never attempt to move a fryer containing hot oil or to transfer hot oil from one container to another.

 **CAUTION** boxes contain information about actions or conditions that *may cause or result in a malfunction of your system.*

 **WARNING** boxes contain information about actions or conditions that *may cause or result in damage to your system,* and which may cause your system to malfunction.

 **DANGER** boxes contain information about actions or conditions that *may cause or result in injury to personnel,* and which may cause damage to your system and/or cause your system to malfunction.

The FQE80U FilterQuick™ easyTouch® electric fryers incorporate a high-temperature detection feature which shuts off power to the elements should the temperature controls fail.

1.3 Controller Information

This equipment has been tested and found to comply with the limits for a Class A digital device, pursuant to Part 15 of the FCC rules. While this device is a verified Class A device, it has been shown to meet the Class B limits. These limits are designed to provide reasonable protection against harmful interference when the equipment is operated in a commercial environment. This equipment generates, uses and can radiate radio frequency energy and, if not installed and used in accordance with the instruction manual, may cause harmful interference to radio communications. Operation of the equipment in a residential area is likely to cause harmful interference in which case the user will be required to correct the interference at their own expense.

The user is cautioned that any changes or modifications not expressly approved by the party responsible for compliance could void the user's authority to operate the equipment.

If necessary, the user should consult the dealer or an experienced radio and television technician for additional suggestions.

The user may find the following booklet prepared by the Federal Communications Commission helpful: "How to Identify and Resolve Radio-TV Interference Problems". This booklet is available from the U.S. Government Printing Office, Washington, DC 20402, Stock No. 004-000-00345-4.

1.4 European Community (CE) Specific Information

The European Community (CE) has established certain specific standards regarding equipment of this type. Whenever a difference exists between CE and non-CE standards, the information or instructions concerned are identified by means of shadowed boxes similar to the one below.

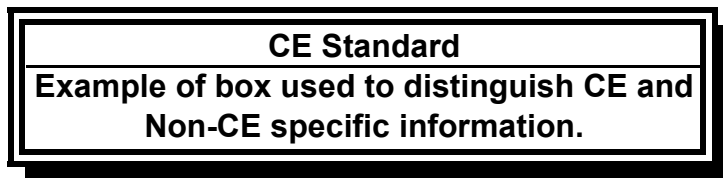

1.5 Installation, Operating, and Service Personnel

Operating information for Frymaster equipment has been prepared for use by qualified and/or authorized personnel only, as defined in Section 1.6. **All installation and service on Frymaster equipment must be performed by qualified, certified, licensed, and/or authorized installation or service personnel, as defined in Section 1.6.**

1.6 Definitions

QUALIFIED AND/OR AUTHORIZED OPERATING PERSONNEL

Qualified/authorized operating personnel are those who have carefully read the information in this manual and have familiarized themselves with the equipment functions, or who have had previous experience with the operation of the equipment covered in this manual.

QUALIFIED INSTALLATION PERSONNEL

Qualified installation personnel are individuals, firms, corporations, and/or companies which, either in person or through a representative, are engaged in and are responsible for the installation of electrical appliances. Qualified personnel must be experienced in such work, be familiar with all electrical precautions involved, and have complied with all requirements of applicable national and local codes.

QUALIFIED SERVICE PERSONNEL

Qualified service personnel are those who are familiar with Frymaster equipment and who have been authorized by Frymaster, L.L.C. to perform service on the equipment. All authorized service personnel are required to be equipped with a complete set of service and parts manuals, and to stock a minimum amount of parts for Frymaster equipment. A list of Frymaster Factory Authorized Servicers (FAS's) is located on the Frymaster website at www.frymaster.com. ***Failure to use qualified service personnel will void the Frymaster warranty on your equipment***

1.7 Shipping Damage Claim Procedure

What to do if your equipment arrives damaged:

Please note that this equipment was carefully inspected and packed by skilled personnel before leaving the factory. The freight company assumes full responsibility for safe delivery upon acceptance of the equipment.

1. **File Claim for Damages Immediately** - regardless of extent of damage.
2. **Inspect for and Record All Visible Loss or Damage and** ensure that this information is noted on the freight bill or express receipt and is signed by the person making the delivery.
3. **Concealed Loss or Damage-** If damage is unnoticed until equipment is unpacked, notify the freight company or carrier **immediately** upon discovery and file a concealed damage claim. This must be submitted within 5 days of date of delivery. Be sure to retain container for inspection.

***Frymaster DOES NOT ASSUME RESPONSIBILITY FOR DAMAGE OR LOSS
INCURRED IN TRANSIT.***

1.8 Reading Model Numbers

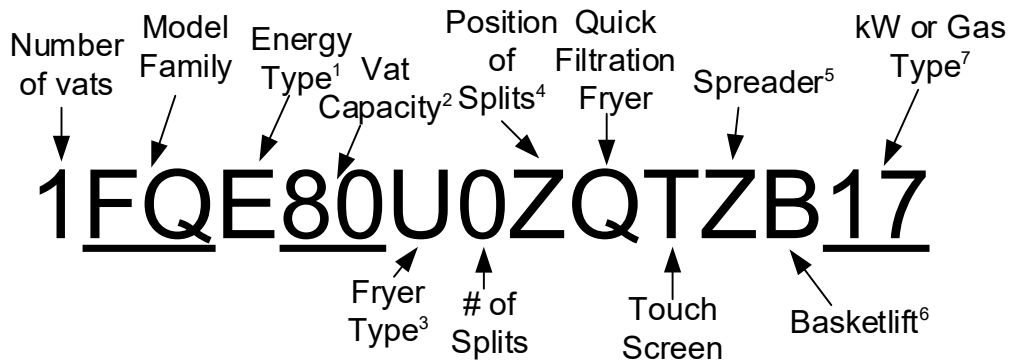

- 1 = E-Electric, G-Gas
- 2 = 30, 40, 50, 60, 80, 100lb frypot capacity
- 3 = U-Open Fryer, T-Tube Fryer
- 4 = L-Left Side, R-Right Side, M-Middle, X-Mixed Positions, Z-All or None if # of Split Vats = 0
- 5 = S-Spreader; Z-none
- 6 = B-Basket Lift; Z-none
- 7 = kW 14, 17, 22 or NG-Natural Gas, PG-Propane Gas, BG-Butane Gas, LG-LP Mix Gas

1.9 Service Information

For non-routine maintenance or repairs, or for service information, contact your local Frymaster Authorized Servicer (FAS). In order to assist you quickly, the Frymaster Authorized Servicer (FAS) or Service Department representative requires certain information about your equipment. Most of this information is printed on a data plate affixed to the inside of the fryer door. Part numbers are found in the Service and Parts Manual. Parts orders may be placed directly with your local FAS or distributor. A list of Frymaster Factory Authorized Servicers (FAS's) is located on the Frymaster website at www.frymaster.com. If you do not have access to this list, contact the Frymaster Service Department at 1-800-551-8633 or 1-318-865-1711 or by email at fryservice@welbilt.com.

The following information will be needed in order to assist you efficiently:

Model Number _____

Serial Number _____

Voltage _____

Nature of the Problem _____

RETAIN AND STORE THIS MANUAL IN A SAFE PLACE FOR FUTURE USE.

FQE80U/FQE100U FILTERQUICK™ easyTouch® SERIES ELECTRIC FRYER

CHAPTER 2: INSTALLATION INSTRUCTIONS

2.1 General Installation Requirements

Proper installation is essential for the safe, efficient, trouble-free operation of this appliance.

Qualified, licensed, and/or authorized installation or service personnel, as defined in Section 1.6 of this manual, should perform all installation and service on Frymaster equipment.

Failure to use qualified, licensed, and/or authorized installation or service personnel (as defined in Section 1.6 of this manual) to install or otherwise service this equipment will void the Frymaster warranty and may result in damage to the equipment or injury to personnel.

Where conflicts exist between instructions and information in this manual and local or national codes or regulations, installation and operation shall comply with the codes or regulations in force in the country in which the equipment is installed.

Service may be obtained by contacting your local Frymaster Authorized Servicer.

NOTICE

All fryers shipped without factory supplied cords and plug assemblies must be hardwired using flexible conduit to the terminal block located on the rear of the fryer. These fryers should be wired to NEC specifications. Hardwired units must include installation of restraint devices.

DANGER

Adequate means must be provided to limit the movement of this appliance without depending on or transmitting stress to the electrical conduit. A restraint kit is provided with the fryer. If the restraint kit is missing contact your local Frymaster Authorized Servicer (FAS).

NOTICE

If this equipment is wired directly into the electrical power supply, a means for disconnection from the supply having a contact separation of at least 3-mm in all poles must be incorporated in the fixed wiring.

NOTICE

This equipment must be positioned so that the plug is accessible unless other means for disconnection from the power supply (e.g., a circuit breaker) is provided.

NOTICE

If this appliance is permanently connected to fixed wiring, it must be connected by means of copper wires having a temperature rating of not less than 167°F (75°C).

NOTICE

If the electrical power supply cord is damaged, it must be replaced by a Frymaster Authorized Servicer or a similarly qualified person in order to avoid a hazard.

⚠ DANGER

This appliance must be connected to a power supply having the same voltage and phase as specified on the rating plate located on the inside of the appliance door.

⚠ DANGER

All wiring connections for this appliance must be made in accordance with the wiring diagram(s) furnished with the appliance. Refer to the wiring diagram(s) affixed to the inside of the appliance door when installing or servicing this equipment.

⚠ DANGER

Do not attach an apron drainboard to a single fryer. The fryer may become unstable, tip over, and cause injury. The appliance area must be kept free and clear of combustible material at all times.

⚠ DANGER

Building codes prohibit a fryer with its open tank of hot oil being installed beside an open flame of any type, including those of broilers and ranges.

In the event of a power failure, the fryer(s) will automatically shut down. If this occurs, turn the power switch OFF. Do not attempt to start the fryer(s) until power is restored.

2.1.1 Clearance and Ventilation

This appliance must be kept free and clear of combustible material, except that it may be installed on combustible floors.

A clearance of 6 inches (15cm) must be provided at both sides and back adjacent to combustible construction. A minimum of 24 inches (61cm) should be provided at the front of the equipment for servicing and proper operation.

⚠ WARNING

Do not block the area around the base or under the fryers.

Added When installing any type of fryer, Standard No. 96 of the National Fire Protection Association must be followed implicitly.

The duct system, the hood and filter bank must be cleaned on a regular basis and kept free of grease according to the NFPA Standard No. 96.

A copy of the standard may be obtained from the National Fire Protection Association, Battery March Park, Quincy, MA 02269 or at www.NFPA.org.

2.1.2 Electrical Grounding Requirements

All electrically operated appliances must be grounded in accordance with all applicable national and local codes, and, where applicable, CE codes. All units (cord connected or permanently connected) should be connected to a grounded power supply system. A wiring diagram is located on the inside of the fryer door. Refer to the rating plate on the inside of the fryer door for proper voltages.

The equipotential grounding lug indicated by illustration (right) allows all the equipment in the same location to be electrically connected to ensure there is no electrical potential difference between the units, which could be hazardous.



2.1.3 Australian Requirements

To be installed in accordance with AS 5601 and AS/NZS 3000:2007 local authorities, gas, electricity, and any other relevant statutory regulations.

If casters are fitted, the installation must comply with AS5601 and AS1869 requirements.

2.2 Power Requirements

The optional three phase supply plug for 208v and 240v delta configuration fryers are rated at 60 amps, 250 VAC and is NEMA configuration 15-60P.

| Three (3) Phase Requirements | | | | | |
|------------------------------|---------|--------------|-------------------|--------|----------------|
| MODEL | VOLTAGE | WIRE SERVICE | MINIMUM WIRE SIZE | | AMPS (per leg) |
| | | | AWG | (mm) | |
| FQE80U/100U 17kW | 208 | 3 | 6 | (4.11) | 48 |
| FQE80U/100U 17kW | 240 | 3 | 6 | (4.11) | 41 |
| FQE80U/100U 17kW | 480 | 3 | 6 | (4.11) | 21 |
| FQE80U/100U 17kW | 220/380 | 4 | 6 | (4.11) | 26 |
| FQE80U/100U 17kW | 240/415 | 4 | 6 | (4.11) | 24 |
| FQE80U/100U 17kW | 230/400 | 4 | 6 | (4.11) | 25 |
| FQE80U/100U 22kW | 208 | 3 | 4 | (5.19) | 61 |
| FQE80U/100U 22kW | 240 | 3 | 4 | (5.19) | 53 |
| FQE80U/100U 22kW | 480 | 3 | 6 | (4.11) | 27 |
| FQE80U/100U 22kW | 220/380 | 4 | 6 | (4.11) | 34 |
| FQE80U/100U 22kW | 240/415 | 4 | 6 | (4.11) | 31 |
| FQE80U/100U 22kW | 230/400 | 4 | 6 | (4.11) | 32 |

NOTICE

If this appliance is permanently connected to fixed wiring, it must be connected by means of copper wires having a temperature rating of not less than 167°F (75°C).

DANGER

This appliance must be connected to a power supply having the same voltage and phase as specified on the rating plate located on the inside of the appliance door.

DANGER

All wiring connections for this appliance must be made in accordance with the wiring diagram(s) furnished with the appliance. Refer to the wiring diagram(s) affixed to the inside of the appliance door when installing or servicing this equipment.

2.3 Positioning the Fryer

DANGER

No structural material on the fryer should be altered or removed to accommodate placement of the fryer under a hood. Questions? Call the Frymaster Dean Service Hotline at 1-800-551-8633.

1. Once the fryer has been positioned at the frying station, use a carpenter's level placed across the top of the frypot to verify that the unit is level, both side-to-side and front-to-back.

To level fryers, adjust the casters being careful to ensure the fryer(s) are at the proper height in the frying station.

When the fryer is leveled in its final position, install the restraints provided by the KES to limit its movement so that it does not depend on or transmit stress to the electrical conduit or connection. Install the restraints in accordance with the provided instructions. If the restraints are disconnected for service or other reasons, they must be reconnected before the fryer is used.

 **DANGER**

Adequate means must be provided to limit the movement of this appliance without depending on or transmitting stress to the electrical conduit. A restraint kit is provided with the fryer. If the restraint kit is missing contact your local KES.

 **DANGER**

Hot oil can cause severe burns. Avoid contact. Under all circumstances, oil must be removed from the fryer before attempting to move it to avoid oil spills, falls and severe burns. This fryer may tip and cause personal injury if not secured in a stationary position.

2. Close fryer drain-valve(s).
3. Clean and fill frypot(s) to the bottom oil level line with cooking oil. (See *Equipment Setup and Shutdown Procedures* in Chapter 3.)

FQE80U/FQE100U FILTERQUICK™ easyTouch® SERIES ELECTRIC FRYER

CHAPTER 3: OPERATING INSTRUCTIONS

FINDING YOUR WAY AROUND THE FQE80U/FQE100U FILTERQUICK™ easyTouch® SERIES ELECTRIC FRYER

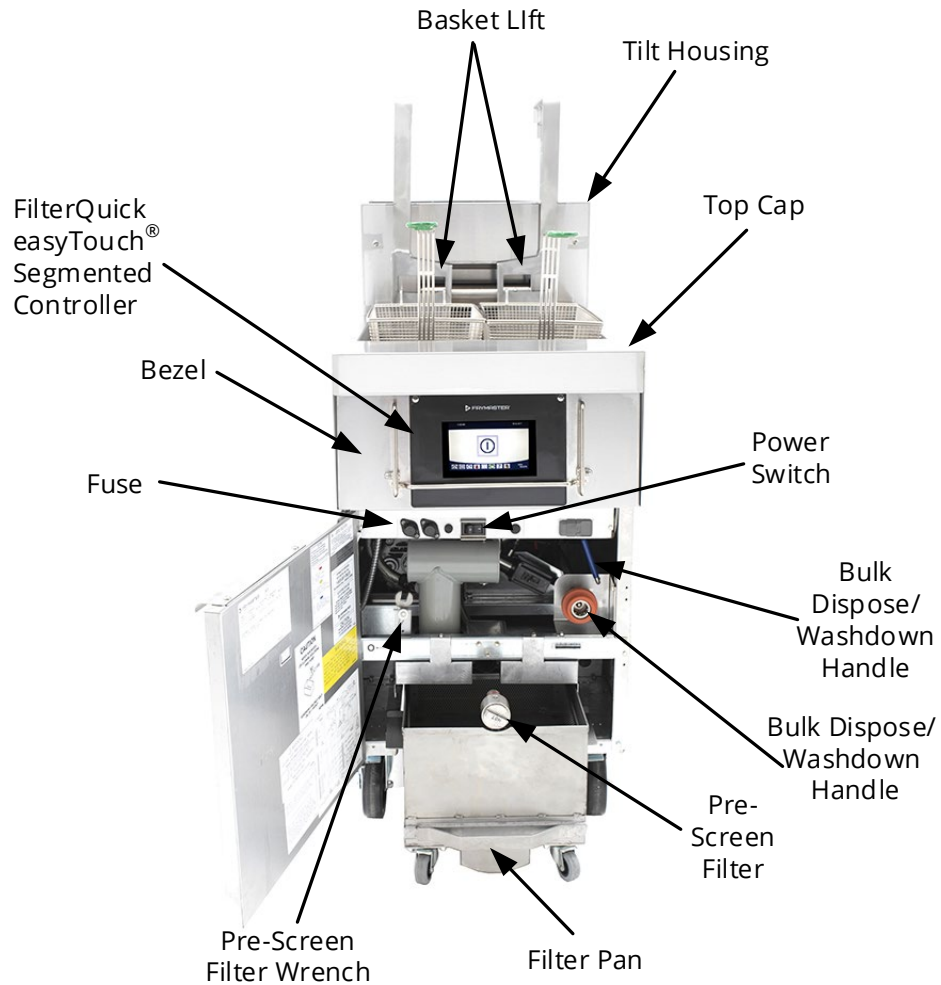

TYPICAL CONFIGURATION (1FQE80U FILTERQUICK™ easyTouch® ELECTRIC SHOWN)

NOTE: The appearance of your fryer may differ slightly from that shown depending upon configuration and date of manufacture.

3.1 Equipment Setup and Shutdown Procedures

Setup

⚠ DANGER

Never operate the appliance with an empty frypot. The frypot must be filled to the fill line with water or oil before energizing the elements. Failure to do so will result in irreparable damage to the elements and may cause a fire.

⚠ DANGER

Remove all drops of water from the frypot before filling with oil. Failure to do so will cause spattering of hot liquid when the oil is heated to cooking temperature.

⚠ WARNING

The FilterQuick™ FQE80U/FQE100U fryer is not intended to use solid shortening without a solid shortening kit installed. Use only liquid shortening with this fryer if a solid shortening kit is not installed. The use of solid shortening without a solid shortening kit will clog the oil lines. The oil capacity of the FQE80U fryer is 78.5 lbs. (11.7 gallons/44.3 liters) at 70°F (21°C). The oil capacity of the FQE100U fryer is 101.8 lbs. (13.9 gallons/52.5 liters) at 70°F (21°C).

1. Fill the frypot with cooking oil or shortening to the bottom OIL LEVEL line located on the rear of the frypot. When using solid shortening, cut it into small pieces and pack it below the elements, between the elements and on top of the elements, leaving no air spaces around the elements. Do not disturb or bend the probe sensing bulbs. This will allow for oil expansion as heat is applied. Do not fill cold oil or shortening any higher than the bottom line; overflow may occur as heat expands the oil/shortening.
2. Ensure that the power cord(s) is/are plugged and locked (if applicable) into the appropriate receptacle(s). Verify that the face of the plug is flush with the outlet plate, with no portion of the prongs visible.
3. Ensure that the power is switched on with the master switch, located behind the fryer door cabinet on the front panel of the component box, next to the fuse.
4. Ensure that the controller is switched ON. The fryer will automatically enter the melt cycle mode if the frypot temperature is below 180°F (82°C) and will display **MELT CYCLE IN PROGRESS**. (**NOTE:** During the melt cycle, the elements will energize for a few seconds, then go out for a longer period.) The shortening must be stirred occasionally during the heating process to ensure all the shortening in the vat is liquefied. When the frypot temperature reaches 180°F (82°C), the unit will automatically switch to the heating mode and **PREHEAT** is displayed until within 15°F (9°C) of setpoint. The elements will remain energized until the frypot temperature reaches the programmed cooking temperature. Once the fryer reaches setpoint, the controller display changes to **START** and the fryer is ready for use. **DO NOT DISABLE OR CANCEL THE MELT CYCLE IF USING SOLID SHORTENING.**
5. Ensure that the oil/shortening level is at the *top* OIL LEVEL line when the oil *is at its cooking temperature*.
6. The maximum batch load for French Fries in oil or fat shall be no more than 1½ pounds or 0.7 kilograms.

Top (Hot) OIL LEVEL line

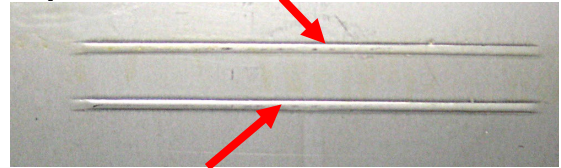

**Bottom (Cold) OIL LEVEL line
FQE80 Fryers**

Shutdown

1. Place the controller ON/OFF switch in the OFF position to turn the fryer off.
2. Filter the oil and clean the fryer (See Chapters 1 and 2 of the FILTERQUICK™ easyTouch® Controller Operation Manual that shipped with the fryer).

- Clean the filter pan and replace the filter paper or pad. Do not leave solid shortening in the filter pan over night.
- Place the frypot covers on the frypots.

3.2 Operation

This fryer is equipped with FilterQuick™ easyTouch® controller(s) (illustrated below). Refer to the *FilterQuick easyTouch® Operation Manual* shipped with your fryer for programming and operating procedures and for operating instructions for the built-in filtration system.



FILTERQUICK™ easyTouch® CONTROLLER

Refer to Chapter 5 of this manual for operating instructions for the built-in filtration system.

3.3 Daily Topping Off

Some fryers prompt twice daily to top off the vats. When the filter timer expires and the oil level is below the top off probe, the display may prompt LOW OIL DETECTED MANUALLY ADD OIL FROM NEXT FRYPOT (see Figure 23). Following the arrows, use a pan to move oil from the next vat to the vat that is low on oil.

Add oil until the level is at the top (**hot**) oil level line (see Figures 24). Repeat on adjacent vats when prompted. On the last vat to be topped off, it prompts LOW OIL DETECTED ADD FRESH SHORTENING (see Figure 25). Add enough fresh shortening to raise the oil level to the top fill line (see Figure 24).

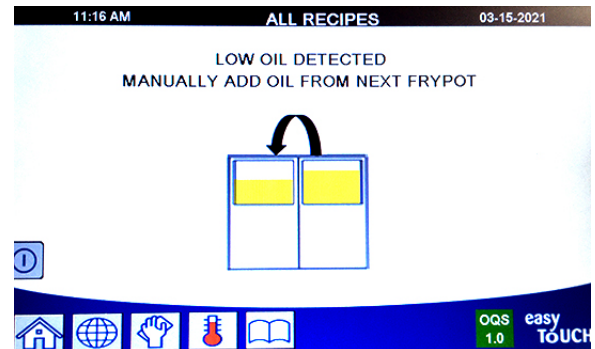

Figure 23

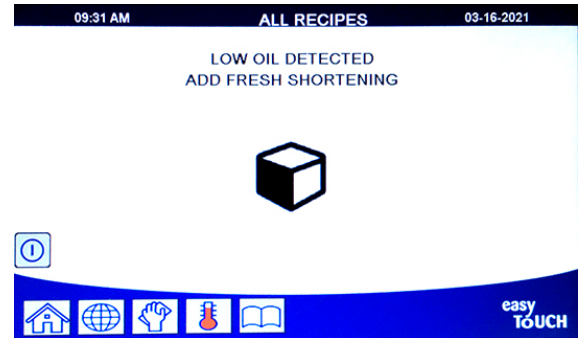

Figure 25



Top (Hot) OIL LEVEL line

Bottom (Cold) OIL LEVEL line

Figure 24 FQE80 Vat Fill Line

FQE80U/FQE100U FILTERQUICK™ easyTouch® SERIES ELECTRIC FRYERS

CHAPTER 4: FILTRATION INSTRUCTIONS

4.1 Introduction

The FQE80U/FQE100U FilterQuick™ easyTouch® filtration system allows the oil in one frypot to be safely and efficiently filtered while the other frypots in a battery remain in operation.

Section 4.2 covers preparation of the filter system for use. Operation of the system is covered in the *FilterQuick™ easyTouch® Controller Manual that shipped with the fryer.*

⚠ WARNING

The on-site supervisor is responsible for ensuring that operators are made aware of the inherent hazards of operating a hot oil filtering system, particularly the aspects of oil filtration, draining and cleaning procedures.

⚠ WARNING

The filter pad or paper MUST be replaced daily or when the sediment level exceeds the height of the hold down ring.

4.2 Preparing Filtration System for Use with Filter Paper or Filter Pad

The FQE80U/FQE100U with FilterQuick™ filtration system uses a filter paper configuration which includes a crumb tray, large hold-down ring, and metal filter screen.

1. Pull the filter pan out from the cabinet and remove the crumb tray, hold-down ring, filter paper and filter screen (see Figure 1). Clean all components with a solution of detergent and hot water then dry thoroughly.

Disposal instructions are in the *FilterQuick™ FQ4000 easyTouch® Controller Manual that shipped with the fryer.*

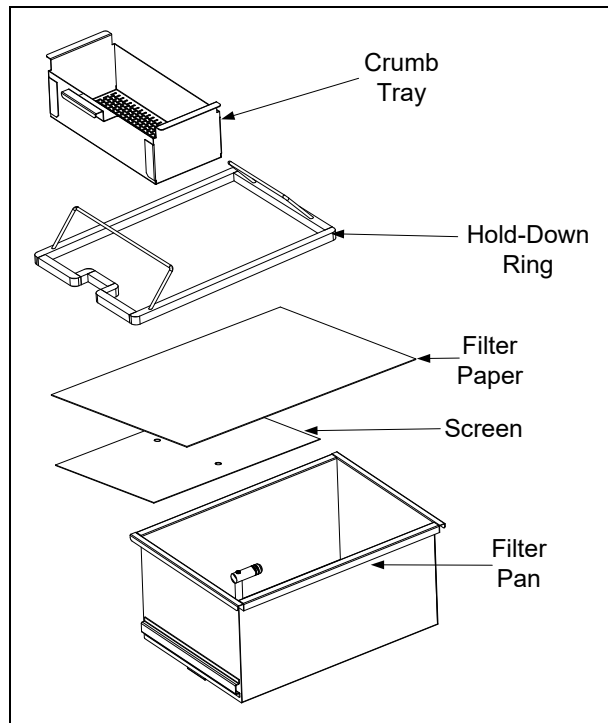

Figure 1

2. Inspect the filter pan connection fitting to ensure that both O-rings are in good condition (see Figure 2).
3. Then in reverse order, place the metal filter screen in the center of the bottom of the pan, then lay a sheet of filter paper on top of the screen, overlapping on all sides (see Figure1). If using a filter pad, ensure the rough side of the pad is up and lay the pad over the screen, making sure that the pad is in between the embossed ridges of the filter pan.
4. Position the hold-down ring over the filter paper and lower the ring into the pan, allowing the paper to rest on the sides of the filter pan (see Figure 3).
5. When the hold-down ring is in position, if using filter paper, sprinkle one packet of filter powder evenly over the paper. (See Figure 4)
6. Replace the crumb tray in the filter pan, then push the filter pan back into the fryer, positioning it under the drain.

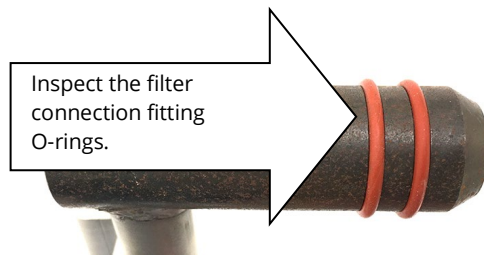

Figure 2



Figure 3

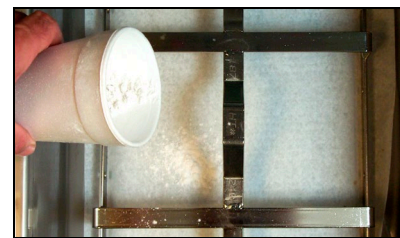

Figure 4

DO NOT USE FILTER POWDER WITH THE PAD!

7. Push the filter pan back into the fryer, positioning it under the fryer. Ensure “P” is **NOT** displayed in the upper right corner of the controller. The filtration system is now ready for use.

⚠ DANGER

Do not drain more than one frypot at a time into the built-in filtration unit to avoid overflow and spillage of hot oil that may cause severe burns, slipping and falling.

⚠ DANGER

The crumb tray in fryers equipped with a filter system must be emptied into a fireproof container at the end of frying operations each day. Some food particles can spontaneously combust if left soaking in certain shortening material.

⚠ WARNING

Do not bang fry baskets or other utensils on the fryer’s joiner strip. The strip is present to seal the joint between the fry vessels. Banging fry baskets on the strip to dislodge shortening will distort the strip, adversely affecting its fit. It is designed for a tight fit and should only be removed for cleaning.

4.3 Preparing the Filtration System for Use with Filter Leaf Envelope Assembly

This section addresses a filtration system that uses a leaf filter screen configuration with a Magnesol filter envelope.

1. Pull the filter pan out from the cabinet and remove the filter leaf assembly by lifting on the pick-up tube assembly (see Figure 5).
2. Clean as directed in section 4.3.1.
NOTE: Refer to Section 4.3.1 for instructions on how to disassemble and reassemble the filter leaf screen assembly.

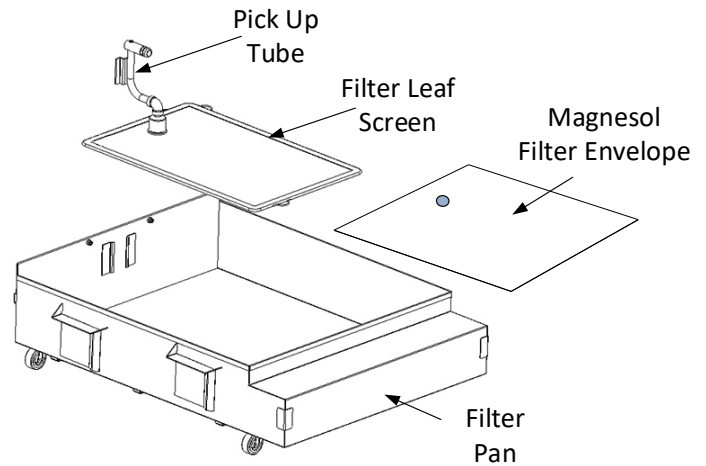

Figure 5

Disposal instructions are in the FQ4000 easyTouch Controller Operation Manual that shipped with the fryer.

3. Inspect the filter pan connection fitting to ensure that both O-rings are present and in good condition. (See Figure 6).

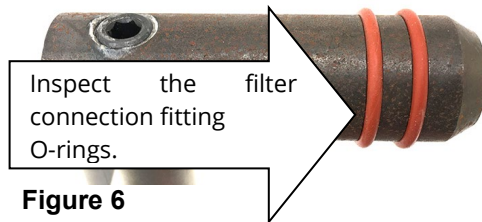

Figure 6

4. Replace the filter leaf assembly in the filter pan, ensuring that the filter pick up tube is lowered and securely mounted into the brackets in the filter pan (see Figure 7).
5. Push the filter pan back into the fryer, positioning it all the way to the back of the cabinet. Ensure "P" is **NOT** displayed on the controller. The filtration system is now ready for use



Figure 7

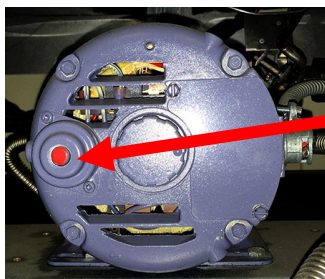

Figure 8

DANGER

Do not drain more than one frypot at a time into the built-in filtration unit to avoid overflow and spillage of hot oil that may cause severe burns, slipping and falling.

⚠ DANGER

The filter pan must be emptied and cleaned at the end of frying operations each day. Some food particles can spontaneously combust if left soaking in certain shortening material.

⚠ WARNING

Do not bang fry baskets or other utensils on the fryer's joiner strip. The strip is present to seal the joint between the fry vessels. Banging fry baskets on the strip to dislodge shortening will distort the strip, adversely affecting its fit. It is designed for a tight fit and should only be removed for cleaning.

⚠ WARNING

The filter pump is equipped with a manual reset switch in case the filter motor overheats, or an electrical fault occurs. If this switch trips, turn off power to the filter system and allow the pump motor to cool 20 minutes before attempting to reset the switch (see Figure 8).

⚠ WARNING

Use caution and wear appropriate safety equipment when resetting the filter pump reset switch. Resetting the switch must be accomplished with care to avoid the possibility of a burn.

4.3.1 Disassembly and Reassembly of the Leaf Screen Filter Assembly

Disassembly

1. Using Figure 9 as a guide, grasp the frame with your thumbs on the handles at the corner of the assembly and pull outward in opposite directions to separate the frame at the corner. Continue to open the frame (it will pivot at the opposite corner) until the outer screens and grid can be removed from the frame.

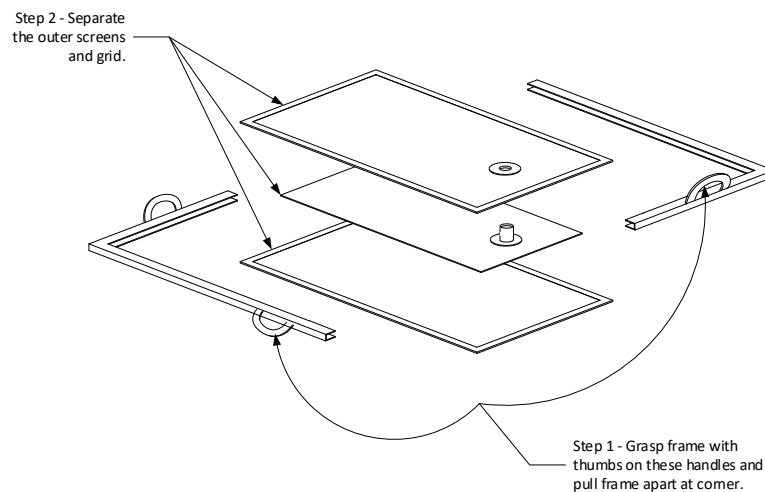

Figure 9

2. Separate the outer screens and grid.

Cleaning

1. Clean the two frame pieces, outer screens, and grid using a good quality degreaser and hot water from a spray nozzle. The groove in the seal frame pieces can be cleaned with the edge of a Scotch-Brite™ or similar cleaning pad.
2. At each scheduled boil-out, disassemble the leaf filter assembly and place in the frypot being boiled out. Follow the boil-out procedure in Section 5.4.2 of this manual.
3. Allow all filter assembly components to air dry or thoroughly dry with clean towels before reassembling.

Reassembly

1. Using Figure 10 as a guide, place the inner insert screen between the filter screens and place either stainless steel channel onto the screens by placing the small corner with the pin and hinged channel over the other side (see Figure 11). Repeat with second channel. NOTE: Channel must be put back starting with the corner pin.

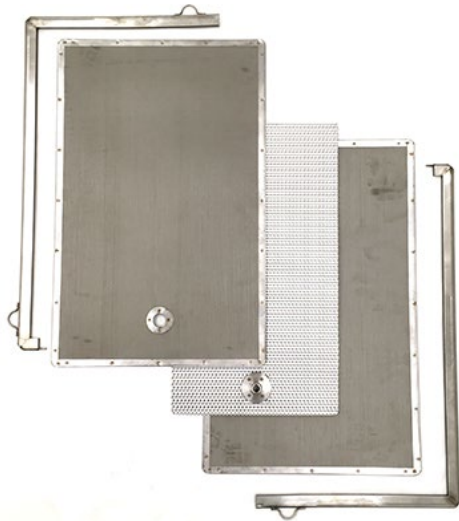

Figure 10



Figure 11

2. Insert the assembly into the filter envelope. The rough side of the envelope should face up (see Figure 12).
3. Ensure the fitting is lined up with the opening and fold over the envelope tab (see Figure 13).



Figure 12



Figure 13

- Carefully screw the pickup tube assembly onto the filter leaf assembly (see Figures 14 and 15).



Figure 14

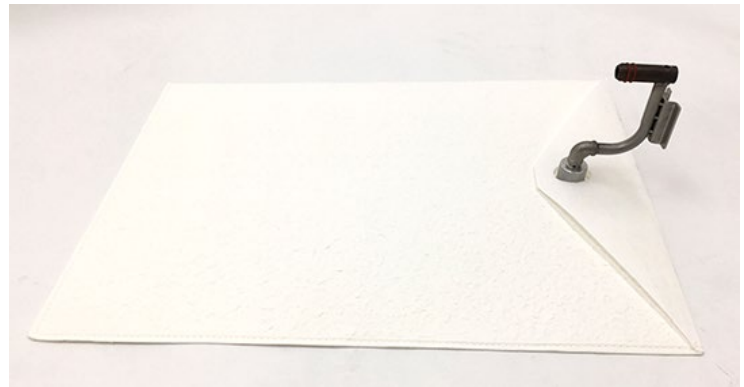

Figure 15

4.3.2 Preparing the FQE80T/FQE100U with Filtration System for Use with MasterFil Envelope Assembly

The FQE80T with fingertip filtration system allows the oil in one frypot to be safely and efficiently filtered while the other frypots in a battery remain in operation. The FQE80T/FQE100U filtration system uses an envelope filter screen configuration with a Masterfil filter envelope.

- Pull the filter pan out from the cabinet and remove the filter envelope assembly by lifting on the pick-up tube assembly.
- Clean as directed in section 4.3.2.1 for the MasterFil assembly.

NOTE: Refer to Section 4.3.2.1 or 4.3.2.2 for instructions on how to disassemble and reassemble the filter envelope screen assembly.

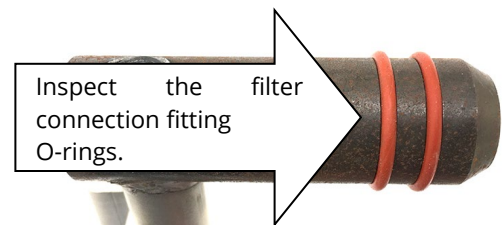

Figure 5

Disposal instructions are in the FQ4000 easyTouch Controller Operation Manual.

- Inspect the filter pan connection fitting to ensure that both O-rings are present and in good condition. (See Figure 5).
- Push the filter pan back into the fryer, positioning it all the way to the back of the cabinet. Ensure "P" is **NOT** displayed on the controller. The filtration system is now ready for use.

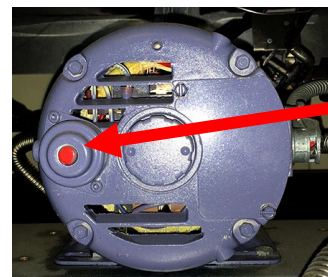

Figure 6

⚠ DANGER

Do not drain more than one frypot at a time into the built-in filtration unit to avoid overflow and spillage of hot oil that may cause severe burns, slipping and falling.

⚠ DANGER

The filter pan must be emptied and cleaned at the end of frying operations each day. Some food particles can spontaneously combust if left soaking in certain shortening material.

⚠ WARNING

Do not bang fry baskets or other utensils on the fryer's joiner strip. The strip is present to seal the joint between the fry vessels. Banging fry baskets on the strip to dislodge shortening will distort the strip, adversely affecting its fit. It is designed for a tight fit and should only be removed for cleaning.

⚠ WARNING

The filter pump is equipped with a manual reset switch in case the filter motor overheats, or an electrical fault occurs. If this switch trips, turn off power to the filter system and allow the pump motor to cool 20 minutes before attempting to reset the switch (see Figure 6).

⚠ WARNING

Use caution and wear appropriate safety equipment when resetting the filter pump reset switch. Resetting the switch must be accomplished with care to avoid the possibility of a burn.

4.3.2.1 Disassembly and Reassembly of the Masterfil Filter Assembly

Disassembly

1. Using Figure 7 as a guide, grasp the pickup tube and handles securing the filter screen and lift upward out of the filter pan.
2. Remove the outer clips (see Figure 8).
3. Lift the pickup tube off of the fitting (see Figure 9).
4. Unscrew the fitting from the screen (see Figure 10)
5. Remove the filter envelope from the sana grid screen (see Figure 11).



Figure 7



Figure 8

Cleaning

1. Clean the filter pan, sana grid, pick up tube, pickup tube base and clips using a good quality degreaser and hot water from a spray nozzle.
2. At each scheduled boil-out, disassemble the filter assembly and place in the frypot being boiled out. Follow the boil-out procedure in the controller manual.
3. Allow all filter assembly components to air dry or thoroughly dry with clean towels before reassembling.



Figure 9



Figure 10



Figure 11

4.3.2.2. Reassembly

1. Reassemble by placing the sana grid inside the filter envelope (see Figure 12).
2. Fold the opening of the envelope under the screen (see Figure 13).
3. Slide the large clip over the folded end (see Figure 14).
4. Slide the small clip over the other end (see Figure 15).
5. Securely screw the fitting to the screen (see Figure 16).
6. Slide pick up tube over fitting (see Figure 17).
7. Insert the filter into the pan. Ensure the pick-up tube is in the pan bracket (see Figure 18).
8. Insert filter pan into fryer. Ensure the **"P"** **IS NOT** visible on the display in upper right corner of the controller. The filtration system is now ready for use.



Figure 12



Figure 13

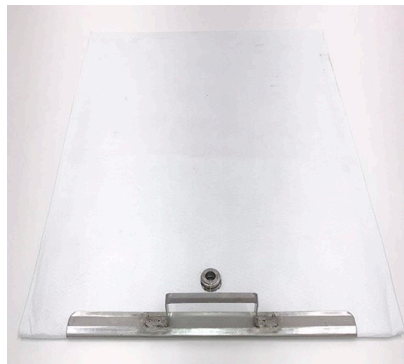

Figure 14



Figure 15



Figure 16



Figure 17



Figure 18

4.4 Daily Topping Off (If applicable)

The fryers prompt twice daily to top off the vats. When the filter timer expires and the oil level is below the top off probe, the display prompts LOW OIL DETECTED MANUALLY ADD OIL FROM NEXT FRYPOT (see Figure 16). Following the arrows, use a pan to move oil from the next vat to the vat that is low on oil.

Add oil until the level is at the top (hot) oil level line (see Figure 17). Repeat on adjacent vats when prompted. On the last vat to be topped off, it prompts LOW OIL

DETECTED ADD FRESH SHORTENING (see Figure 18). Add enough fresh shortening to raise the oil level to the top fill line (see Figure 17).

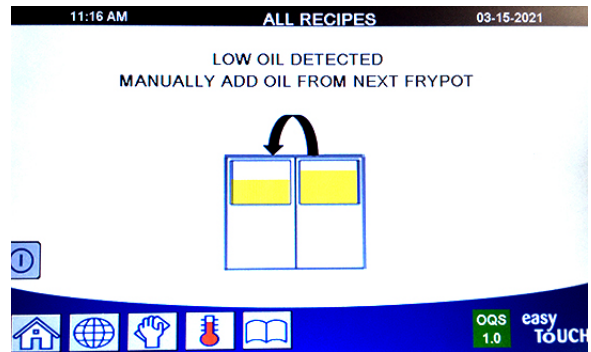
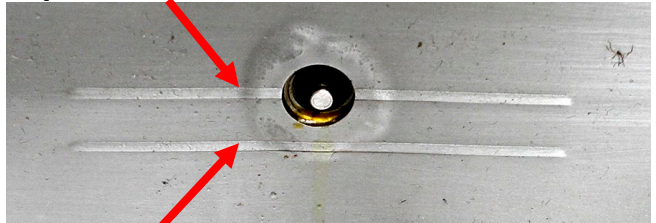

Figure 16

Top (Hot) OIL LEVEL line



Bottom (Cold) OIL LEVEL Line

Figure 17

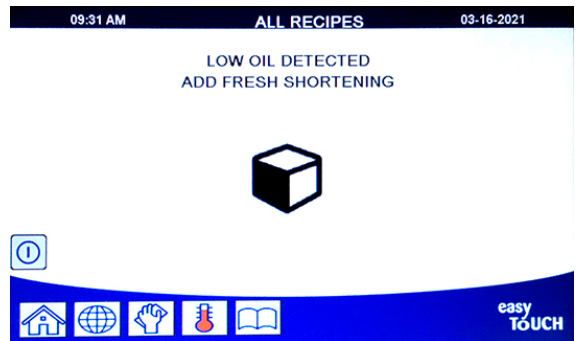

Figure 18



FQE80U/FQE100U FILTERQUICK™ easyTouch® SERIES ELECTRIC FRYER

CHAPTER 5: PREVENTATIVE MAINTENANCE

5.1 Cleaning the Fryer

 **DANGER**

The crumb tray and filter pan in fryers equipped with a filter system must be emptied into a fireproof container at the end of frying operations each day. Some food particles can spontaneously combust if left soaking in certain shortening material.

 **DANGER**

Never attempt to clean the fryer during the frying process or when the frypot is filled with hot oil. If water comes in contact with oil heated to frying temperature, it will cause spattering of the oil, which can result in severe burns to nearby personnel.

 **WARNING**

Use a commercial-grade cleaner formulated to effectively clean and sanitize food-contact surfaces. Read the directions for use and precautionary statements before use. Particular attention must be paid to the concentration of cleaner and the length of time the cleaner remains on the food-contact surfaces.

5.2 DAILY CHECKS AND SERVICE

5.2.1 Inspect Fryer and Accessories for Damage- Daily

Look for loose or frayed wires and cords, leaks, foreign material in frypot or inside cabinet, and any other indications that the fryer and accessories are not ready and safe for operation.

5.2.2 Clean Inside and Outside of the Fryer Cabinet - Daily

Clean inside the fryer cabinet with a dry, clean cloth. Wipe all accessible metal surfaces and components to remove accumulated oil and dust.

Clean outside the fryer cabinet with a clean, damp cloth soaked with detergent. Wipe with a clean, damp cloth.

5.2.3 Clean the Built-In Filtration System Daily

 **WARNING**

Never operate the filter system without oil in the system.

 **WARNING**

Never use the filter pan to transport old oil to the disposal area.

 **WARNING**

Never drain water into the filter pan. Water will damage the filter pump.

1. Daily perform a clean and filter of each frypot (see Clean and Filter procedure instructions in the FQ4000 easyTouch *Controller* manual *that shipped with the fryer*).
2. Daily clean the filter pan and associated components with a solution of hot water and detergent.

If you notice that the system is pumping slowly or not at all, verify that the filter pan screen is on the bottom of the filter pan, with the paper on top of the screen. Verify that the two O-ring(s) on the fitting at the right front of the filter pan are present and in good condition. Verify that the pre-filter is clean and tightened with the wrench.

5.2.4 Clean Filter Pan, Detachable Parts and Accessories

Carbonized oil will accumulate on the filter pan and detachable parts and accessories such as baskets, sediment trays, or fish plates.

Wipe the filter pan and all detachable parts and accessories with a clean cloth dampened with a detergent solution (or the parts can be run through a dishwasher). Rinse and thoroughly dry each part. DO NOT use steel wool or abrasive pads to clean these parts. The scratches that result from such scrubbing make subsequent cleanings more difficult.

5.2.5 Clean around AIF and ATO sensors - Daily

1. Clean the sediment from around the AIF and ATO sensors during clean and filter when the oil is drained from the frypot.
2. Use a screwdriver or other similar object which allows access around the probe (see Figure 1). Use caution to ensure that the probe is not damaged.
3. Return the oil once the clean and filter is complete.

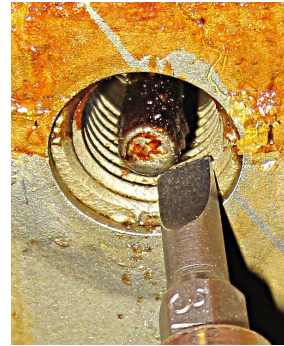

Figure 1

5.2.6 Clean Basket Lift Rods - Daily

On fryers equipped with basket lifts, wipe down the rods with dry, clean cloth to remove accumulations of oil and dust.

5.3 WEEKLY CHECKS AND SERVICE

5.3.1 Clean Behind Fryers - Weekly

Clean behind fryers in accordance with store procedures. Shut the fryer off and disconnect power.

5.4 MONTHLY CHECKS AND SERVICE

5.4.1 Drain, Clean Frypot and Heating Elements



DANGER

Never operate the appliance with an empty frypot. The frypot must be filled to the fill line with water or oil before energizing the elements. Failure to do so will result in irreparable damage to the elements and may cause a fire.

After the fryer has been in use for a period of time, a hard film of caramelized oil will form on the inside of the frypot. This deposit must be periodically removed to maintain your fryer's efficiency.

See the Clean and Filter procedure instructions in the FilterQuick™ easyTouch® controller manual that shipped with the fryer to clean the frypot.

5.4.2 Deep Cleaning (Boiling Out/Cold Clean) the Frypot – Minimally Monthly

During normal usage of your fryer, a deposit of carbonized oil will gradually form on the inside of the frypot. This film should be periodically removed by following the Clean (boil-out) procedure. *Refer to the FilterQuick™ easyTouch® Controller Operation Manual that shipped with the fryer for specific details on setting up the controller for clean (boil-out) operation.*

⚠ DANGER

Never operate the appliance with an empty frypot. The frypot must be filled to the fill line with water or cooking oil before energizing the elements. Failure to do so will result in irreparable damage to the elements and may cause a fire.

⚠ DANGER

Allow oil to cool to 100°F (38°C) or lower before draining to an appropriate container for disposal.

⚠ WARNING

Never leave the fryer unattended during this process. If the solution overflows, press the ON/OFF switch to the OFF position immediately.

⚠ DANGER

Ensure that the frypot is completely free of water before filling with oil. When the oil is heated to cooking temperature, water in the frypot will cause splattering.

⚠ WARNING

To prevent injury, ensure adjacent vats that contain oil are OFF and covered prior to performing a Hot Clean (Boil Out) or Cold Clean (Cold Soak).

5.4.3 Pre-filter Maintenance - Monthly

The pre-filter requires regular maintenance. Every 30 days, or more frequently if the flow of oil slows, remove the cap and clean the attached screen.

⚠ DANGER

Wear protective gloves when removing the pre-filter. The filter may be hot and cause severe burns.

1. **Wearing protective gloves** use the supplied wrench to remove the cap from the pre-filter (**Figure 2**).
2. Use a small brush to clear debris from the attached screen (**Figure 3**).
3. Clean under a water tap and thoroughly dry.
4. Return the cap to the pre-filter housing and **tighten with the attached wrench**, ensuring the pre-filter is tight. If the cap is not tight, air will leak around the pre-filter and slow the return.

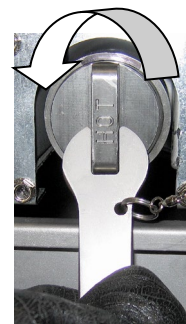

Figure 2

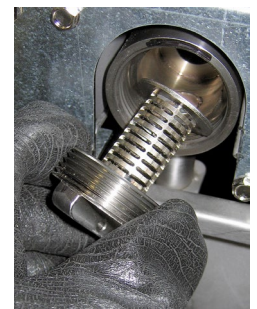



Figure 3

⚠ WARNING

DO NOT remove the pre-filter cap when a filter cycle is under way.

DO NOT operate the filter system with the cap removed. Wear protective gloves when handling the cap. The metal and the exposed oil are hot.

5.4.4 Check FilterQuick™ easyTouch® Controller Set Point Accuracy - Monthly

1. Insert a good-grade thermometer or pyrometer probe into the oil, with the end touching the fryer temperature-sensing probe.
2. When the controller product icons are visible (indicating that the frypot contents are within the cooking range), press the  button once to display the temperature and setpoint of the oil as sensed by the temperature probe.
3. Note the temperature on the thermometer or pyrometer. Actual temperature and pyrometer readings should be within $\pm 5^{\circ}\text{F}$ (3°C) of each other after allowing the heat to cycle on and off three (3) times. If the temperature is still out of tolerance, contact a Factory Authorized Servicer for assistance.

5.5 QUARTERLY CHECKS AND SERVICE

5.5.1 Replace the O-rings

Refer to page 4-2 for inspection of O-rings.

5.6 ANNUAL/PERIODIC SYSTEM INSPECTION

This appliance should be inspected and adjusted periodically by qualified service personnel as part of a regular kitchen maintenance program.

Frymaster recommends that this appliance be inspected at least annually by a Factory Authorized Servicer as follows:

5.6.1 Fryer

- Inspect the cabinet inside and out, front and rear for excess oil.
- Verify that the heating element wires are in good condition and that leads have no visible fraying or insulation damage and that they are free of oil.
- Verify that heating elements are in good condition with no carbon/caramelized oil build-up. Inspect the elements for signs of extensive dry-firing.
- Verify that the tilt mechanism is working properly when lifting and lowering elements, and that the element wires are not binding and/or chafing.
- Verify the heating-element amp-draw is within the allowed range as indicated on the appliance's rating plate.
- Verify that the temperature and high-limit probes are properly connected, tightened and functioning properly, and that mounting hardware and probe guards are present and properly installed.
- Verify that component box and contactor box components (i.e. controller, relays, interface boards, transformers, contactors, etc.) are in good condition and free from oil and other debris.
- Verify that component box and contactor box wiring connections are tight, and that wiring is in good condition.
- Verify that all safety features (i.e. contactor shields, drain safety switches, reset switches, etc.) are present and functioning properly.
- Verify that the frypot is in good condition and free of leaks and that the frypot insulation is in serviceable condition.
- Verify that all wiring harnesses and connections are tight and in good condition.

5.6.2 Built-In Filtration System- Annual

- Inspect all oil-return and drain lines for leaks and verify that all connections are tight.
- Inspect the filter pan for leaks and cleanliness. If there is a large accumulation of crumbs in the crumb basket, advise the owner/operator that the crumb basket should be emptied into a fireproof container and cleaned daily.
- Verify that all O-rings and seals (including those on the quick-disconnect fittings) are present and in good condition. Replace O-rings and seals if worn or damaged.
- Check filtration system integrity as follows:
 - Verify that filter pan cover is present and properly installed.
 - With the filter pan empty, place each vat into fill vat from filter pan selection (see section 2.1.7 of the *FilterQuick™ easyTouch® Controller Operation Manual that shipped with the fryer*), one at a time. Verify proper functioning of each oil return valve by activating the filter pump using the fill vat from drain pan selection. Verify that the pump activates and that bubbles appear in the cooking oil of the associated frypot.
 - Verify that the filter pan is properly prepared for filtering, then drain a frypot of oil heated to 350°F (177°C) into the filter pan by using the drain to pan selection (see section 2.1.10 of the *FilterQuick™ easyTouch® Controller Operation Manual that shipped with the fryer*). Now using the fill vat from pan drain pan selection (see section 2.1.7 of the *FilterQuick™ easyTouch® Controller Operation Manual that shipped with the fryer*), allow all oil to return to the frypot (indicated by bubbles in the cooking oil). Press the check button when all oil is returned. The frypot should have refilled in approximately 5 minutes.

5.6.3 Stainless Steel Care



DO NOT let water splash into the tank of hot oil. It will splatter and can cause severe burns.

All stainless-steel fryer cabinet parts should be wiped regularly with hot, soapy water during the day, and with a liquid cleanser designed for stainless steel at the end of each day.

1. Do not use steel wool, abrasive cloths, cleansers or powders.
2. Do not use a metal knife, spatula or any other metal tool to scrape stainless steel! Scratches are almost impossible to remove.
3. If it is necessary to scrape the stainless steel to remove any encrusted materials, soak the area first to soften the deposit, then use a wood or nylon scraper only.

FQE80U/FQE100U FILTERQUICK™ easyTouch® SERIES ELECTRIC FRYER

CHAPTER 6: OPERATOR TROUBLESHOOTING

6.1 Introduction

This section provides an easy reference guide to some of the common problems that may occur during the operation of this equipment. The troubleshooting guides that follow are intended to help correct, or at least accurately diagnose, problems with this equipment. Although the chapter covers the most common problems reported, you may encounter problems that are not covered. In such instances, the Frymaster Technical Services staff will make every effort to help you identify and resolve the problem.

When troubleshooting a problem, always use a process of elimination starting with the simplest solution and working through to the most complex. Never overlook the obvious – anyone can forget to plug in a cord or fail to close a valve completely. Most importantly, always try to establish a clear idea of why a problem has occurred. Part of any corrective action involves taking steps to ensure that it doesn't happen again. If a controller malfunctions because of a poor connection, check all other connections, too. If a fuse continues to blow, find out why. Always keep in mind that failure of a small component may often be indicative of potential failure or incorrect functioning of a more important component or system.

Before calling a service agent or the Frymaster HOTLINE (1-800-24-FRYER):

- **Verify that electrical cords are plugged in and that circuit breakers are on.**
- **Have your fryer's model and serial numbers ready to give to the technician assisting you.**

 **DANGER**

Hot oil will cause severe burns. Never attempt to move this appliance when filled with hot oil or to transfer hot oil from one container to another.

 **DANGER**

This equipment should be unplugged when servicing, except when electrical circuit tests are required. Use extreme care when performing such tests.

This appliance may have more than one electrical power supply connection point. Disconnect all power cords before servicing.

Inspection, testing, and repair of electrical components should be performed by an authorized service agent only.

6.2 Troubleshooting

6.2.1 Controller and Heating Problems

| Problem | Probable Causes | Corrective Action |
|--|---|---|
| No display on the controller. | A. No power to fryer. B. Failed controller or another component | A. Verify that the fryer is plugged in and that the circuit breaker is not tripped. B. Call your FAS for assistance. |
| CONTROLLER displays IS VAT FULL? YES NO after a filtration. | A. Normal operation during most at the beginning or end of most filtration functions. B. If the display appears many times during a filter it could be an indication of slow oil return. | A. Ensure the vat is full of oil and press the √ button. B. See section 5.3 troubleshooting – Filter Pump runs, but oil return is very slow. |
| CONTROLLER displays IS DRAIN CLEAR? | Drain is clogged, and oil failed to drain. | Clear drain with Fryers Friend and press √ button. Filtration will resume. |
| CONTROLLER displays CHANGE FILTER PAD? | Filter error has occurred, filter pad clogged, 25-hour filter pad change prompt has occurred or change filter pad was ignored on a prior prompt. | Change the filter pad and ensure the filter pan has been removed from the fryer for a minimum of 30 seconds. Do NOT ignore CHANGE FILTER PAD prompts. |
| Fryer does not heat. | A. Power cord(s) not plugged in. | A. Verify that all the power cord(s) are fully seated in their receptacle(s), locked into place and that circuit breaker is not tripped |
| | B. Controller or other components have failed. | B. Call your FAS for assistance. |
| Fryer heats until high-limit trips with heat indicator ON. | Temperature probe or controller has failed. | Call your FAS for assistance. |
| Fryer heats until high-limit trips without heat indicator ON. | Contact or controller has failed | Call your FAS for assistance. |
| CONTROLLER displays MISCONFIGURED ENERGY TYPE | Energy type in fryer setup is incorrect. | Ensure that the fryer is configured properly for the correct energy type. |
| CONTROLLER displays VAT ID CONNECTOR NOT CONNECTED | Controller locator missing or disconnected. | Ensure the 6-pin locator is connected to rear of controller and it properly grounded in control box. |
| Controller locks up. | Controller error. | Remove and restore power to the controller. If problem persists, call your FAS for assistance. |

6.2.2 Error Messages and Display Problems

| Problem | Probable Causes | Corrective Action |
|--|---|---|
| CONTROLLER displays E19 HEATING FAILURE. | Failed controller, failed transformer, failed SIB board, open high-limit thermostat. | Call your FAS for assistance. |
| CONTROLLER display is in wrong temperature scale (Fahrenheit or Celsius). | Incorrect display option programmed. | Toggle between F° to C° by entering Manager settings, temperature and toggling the temperature scale. Turn the controller on to check temperature. If the desired scale is not displayed, repeat. |
| CONTROLLER displays HOT-HI-1. | Frypot temperature is more than 410°F (210°C) or, in CE countries, 395°F (202°C). | Shut the fryer down immediately and call your FAS for assistance. |
| CONTROLLER displays HELP HI-2 or HIGH LIMIT FAILURE DISCONNECT POWER. | Failed high limit | Disconnect power from the entire fryer immediately and call your FAS for assistance. |
| CONTROLLER displays TEMPERATURE PROBE FAILURE. | Problem with the temperature measuring circuitry including the probe or damaged controller wiring harness or connector. | Shut the fryer down and call your FAS for assistance. |
| Heating indicator is on, but fryer is not heating. | Three phase power cord unplugged, or circuit breaker is tripped. | Verify that all power cord(s) are fully seated in their receptacle(s), locked into place and that circuit breaker is not tripped. If the problem continues call your FAS for assistance. |
| CONTROLLER displays RECOVERY FAULT and alarm sounds. | Recovery time exceeded maximum time limit. | Clear error and silence the alarm by pressing the √ button. Maximum recovery time for electric is 4:00 minutes. If this error continues call your FAS for assistance. |
| CONTROLLER displays NO MENU GROUP AVAILABLE FOR SELECTION | All menu groups have been deleted. | Create a new MENU group. Once a new menu is created, add recipes to the group (see section 1.10 of the CONTROLLER manual). |
| CONTROLLER displays SERVICE REQUIRED followed by an error message. | An error has occurred which requires a service technician. | Press X to continue cooking and call your FAS for assistance. In some cases, cooking may not be available. |

6.2.3 Filtration Problems

| Problem | Probable Causes | Corrective Action |
|---|---|--|
| Fryer filters after each cook cycle. | Filter after setting incorrect. | Change or overwrite the filter after setting by re-entering the filter after value in Manager Settings, Filter Attributes in section 1.8 of the CONTROLLER manual. |
| Clean and Filter won't start. | Temperature too low. | Ensure fryer is at setpoint before starting a Clean and Filter. |
| CONTROLLER display shows FILTER BUSY. | <ul style="list-style-type: none"> A. Another filtration cycle or filter pad change is still in process. B. Filter interface board has not cleared checking system. | <ul style="list-style-type: none"> A. Wait until the previous filtration cycle ends to start another filtration cycle. Change filter pad if prompted. B. Wait 15 minutes and try again. |
| Filter pump won't start, or pump stops during filtering. | <ul style="list-style-type: none"> A. Power cord is not plugged in or circuit breaker is tripped. B. Pump motor has overheated causing the thermal overload switch to trip. C. Blockage in filter pump. | <ul style="list-style-type: none"> A. Verify that the power cord is fully plugged in and the circuit breaker is not tripped. B. If the motor is too hot to touch for more than a few seconds, the thermal overload switch has probably tripped. Allow the motor to cool at least 45 minutes then press the Pump Reset Switch (see section 2.1.2 of the CONTROLLER manual). C. Call your FAS for assistance. |
| Drain valve or return valve stays open. | <ul style="list-style-type: none"> A. VIB board has failed. B. Actuator has failed. | Call your FAS for assistance. |
| CONTROLLER display shows INSERT pan. | <ul style="list-style-type: none"> A. Filter pan is not fully set into fryer. B. Missing filter pan magnet. C. Defective filter pan switch. | <ul style="list-style-type: none"> A. Pull filter pan out and fully reinsert into fryer. Ensure controller does not display P. B. Ensure the filter pan magnet is in place and replace if missing. C. If the filter pan magnet is fully against the switch and controller continues to display INSERT PAN, switch is possibly defective. |
| Auto filtration, OQS filter won't start. | <ul style="list-style-type: none"> A. Oil level too low. B. Oil temperature is too low. C. Filter Pan out. D. Filtration in recipe settings is set to OFF. E. Filter relay has failed. | <ul style="list-style-type: none"> A. Ensure oil level is at the top oil fill line (at the top oil level sensor). B. Ensure the oil temperature is at setpoint. C. Ensure controller does not display P. Ensure the filter pan is fully seated into fryer. Power cycle the fryer. D. Set filtration in recipes to ON. E. Call your FAS for assistance. |



| Problem | Probable Causes | Corrective Action |
|---|---|---|
| Filter Pump runs, but oil return is very slow. | <ul style="list-style-type: none"> A. Clogged filter pad/paper. B. Improperly installed or prepared filter pan components. C. Pre-filter screen may be clogged or not fully tightened. | <ul style="list-style-type: none"> A. Ensure the filter is not clogged. If so replace the filter. B. Remove the oil from the filter pan and replace the filter pad/paper, ensuring that the filter screen is in place under the pad/paper. Verify, if using a pad, that the rough side is facing up. Verify that O-rings are present and in good condition on filter pan connection fitting. C. Clean pre-filter (see section 4.5.4) and ensure it is tightened with the attached wrench. |

6.2.3.1 Incomplete Filtration

Should the auto filtration procedure fail an error message is generated. Follow the instructions on the screen to return the oil and clear the error.

| DISPLAY | ACTION |
|----------------------|---|
| IS VAT FULL? | 1. Press the √ (check) button if the vat is full to continue. The controller returns to idle cook mode or . Press X if vat is not filled completely. |
| FILLING IN PROGRESS | 2. No action required as the pump runs. |
| IS VAT FULL? | 3. Press the √ (check) button if the vat is full to continue. The controller returns to idle cook mode or . Press X if vat is not filled completely. |
| FILLING IN PROGRESS | 4. No action required as the pump runs. |
| IS VAT FULL? | 5. Press the √ (check) button if the vat is full to continue. The controller returns to idle cook mode or . Press X if vat is not filled completely. If this is the sixth consecutive sequence of incomplete filtration skip to step 10. |
| CHANGE FILTER PAPER? | 6. Press the √ (check) button to continue. Pressing X advances to . |
| REMOVE PAN | 7. Remove the filter pan. |
| CHANGE FILTER PAPER | 8. Change the filter paper/pad and ensure the filter pan has been pulled forward, out of the cabinet for at least 30 seconds. Once the pan has been out for 30 seconds the controller returns to idle cook mode. Ensure the pan is dry and assembled correctly. Push the filter pan back into the fryer. Ensure "P" is not displayed on the controller. |
| IS VAT FULL? | 9. Press the √ (check) button if the vat is full to continue. The controller returns to idle cook mode. Press X if vat is not full and the controller advances to . |

| | |
|---|--|
| SERVICE REQUIRED | 10. If a filtration error occurs six consecutive times, the return valve closes. Press the √ (check) button to silence alarm and continue. |
| ERROR PUMP NOT FILLING | 11. The system detects oil is not returning to the vat and service is required. Call your FAS. |
| SYSTEM ERROR FIXED? | 12. Press the X button to continue cooking if possible. Call your FAS to repair and reset the fryer. The error will be re-displaying every 15 minutes until the issue is repaired. Auto filtration and auto top off are disabled until the fryer is reset. |
| ENTER CODE | 13. FAS tech enters tech code to reset fryer. |
| FILL VAT FROM DRAIN PAN? | 14. Press the √ (check) button to fill the vat from filter pan to continue. Follow prompts once the vat is full. Press X to skip filling from drain pan. |
| REMOVE PAN | 15. Remove the filter pan. |
| IS PAN EMPTY? | 16. Press the √ (check) button if the filter pan is empty and continue to next step. Press X to continue filling the vat. Follow the prompts once the vat is full. |
|  | 17. The controller switches off. |

6.2.3.2 Clogged Drain Error

The clogged drain error occurs during auto filtration when the oil level sensor detects that oil has not completely drained from the frypot. This may be due to a clogged drain or an oil sensor failure. Follow the instructions on the controller display to clear the error.

When this occurs the controller displays **CLEAR DRAIN** for 15 seconds changing to **IS DRAIN CLEAR?**

1. Clear debris from the drain using the fryer's friend and press the √ button to continue.
2. The controller displays **DRAINING**. Once the oil level sensor detects the oil has drained, normal auto filtration operation resumes.

6.2.3.3 Filter Busy

When **FILTER BUSY** is displayed the filter interface board is waiting on another vat to be filtered or waiting on another function to finish. Wait 15 minutes to see if problem is corrected. If not, call your local FAS.

6.2.4 Basket Lift Problems

| Problem | Probable Causes | Corrective Action |
|--|------------------------------------|---|
| Basket lift movement is jerky and/or noisy. | Basket lift rods need lubrication. | Apply a light coating of Lubriplate™ or similar lightweight white grease to the rod and bushings. |

6.2.5 Error Log Codes

See section 1.12.2.1 in the FilterQuick™ easyTouch® Segmented Controller Manual for instructions to access the Error Log.

| Code | ERROR MESSAGE | EXPLANATION |
|------|---|--|
| E13 | TEMPERATURE PROBE FAILURE | TEMP Probe reading out of range |
| E16 | HIGH LIMIT 1 EXCEEDED | High limit temperature is past more than 410°F (210°C), or in CE countries, 395°F (202°C) |
| E17 | HIGH LIMIT 2 EXCEEDED | High limit switch has opened. |
| E18 | HIGH LIMIT PROBLEM DISCONNECT POWER | Vat temperature exceeds 460°F (238°C) and the high limit has failed to open. Immediately disconnect power to the fryer and call service. |
| E19 | HEATING FAILURE – XXX F or XXX C | Heating Control latch circuit failed. Heat Contactor failed to latch. |
| E25 | HEATING FAILURE - BLOWER | The air pressure switch(s) failed to close. |
| E27 | HEATING FAILURE - PRESSURE SWITCH - CALL SERVICE | The air pressure switch has failed closed. |
| E28 | HEATING FAILURE – XXX F or XXX C | The fryer has failed to ignite and has locked out the ignition module. |
| E29 | TOP OFF PROBE FAILURE - CALL SERVICE | ATO RTD reading out of range |
| E32 | DRAIN VALVE NOT OPEN - FILTRATION AND TOP OFF DISABLED - CALL SERVICE | Drain valve was trying to open and confirmation is missing |
| E33 | DRAIN VALVE NOT CLOSED - FILTRATION AND TOP OFF DISABLED - CALL SERVICE | Drain valve was trying to close and confirmation is missing |
| E34 | RETURN VALVE NOT OPEN - FILTRATION AND TOP OFF DISABLED - CALL SERVICE or RIGHT VALVE NOT OPEN for multi- return valve systems. | Return valve or Right valve (multi-return valve systems) was trying to open and confirmation is missing |
| E35 | RETURN VALVE NOT CLOSED - FILTRATION AND TOP OFF DISABLED - CALL SERVICE or RIGHT VALVE NOT CLOSED for multi- return valve systems. | Return valve or Right valve (multi-return valve systems) was trying to close and confirmation is missing |
| E36 | VALVE INTERFACE BOARD FAILURE - FILTRATION AND TOP OFF DISABLED - CALL SERVICE | Valve Interface Board connections lost or board failure. |
| E37 | AUTOMATIC INTERMITTENT FILTRATION PROBE FAILURE - FILTRATION DISABLED - CALL SERVICE | AIF RTD reading out of range. |
| E39 | CHANGE FILTER PAD | 25-hour timer has expired or dirty filter logic has activated. |
| E41 | OIL IN PAN ERROR | The system detects that oil may be present in the filter pan. |
| E42 | CLOGGED DRAIN (Gas) | Vat did not empty during filtration |
| E43 | OIL SENSOR FAILURE - CALL SERVICE | Oil level sensor may have failed. |
| E44 | RECOVERY FAULT | Recovery time exceeded maximum time limit. |
| E45 | RECOVERY FAULT – CALL SERVICE | Recovery time exceeded maximum time limit for two or more cycles. |
| E46 | SYSTEM INTERFACE BOARD 1 MISSING - CALL SERVICE | SIB board 1 connection lost or board failure. |
| E51 | DUPLICATE BOARD ID - CALL SERVICE | Two or more controllers have the same location ID. |
| E52 | USER INTERFACE CONTROLLER ERROR - CALL SERVICE | The controller has an unknown error. |
| E53 | CAN BUS ERROR - CALL SERVICE | Communications are lost between boards. |
| E54 | USB ERROR | USB connection lost during an update. |
| E55 | SYSTEM INTERFACE BOARD 2 MISSING - CALL SERVICE | SIB board 2 connection lost or board failure. |
| E61 | MISCONFIGURED ENERGY TYPE | The fryer is configured for the incorrect energy type. |
| E62 | VAT NOT HEATING – CHECK ENERGY SOURCE – XXXF OR XXXC | The vat is not heating properly. |
| E63 | RATE OF RISE | Rate of rise error occurred during a recovery test. |
| E64 | FILTRATION INTERFACE BOARD FAILURE - FILTRATION AND TOP OFF DISABLED - CALL SERVICE | Filtration Interface Board connections lost or board failure. |
| E65 | CLEAN OIB SENSOR – XXX F OR XXX C - CALL SERVICE | Gas Only -The oil is back sensor does not detect oil. Clean oil sensor. |
| E66 | DRAIN VALVE OPEN – XXXF OR XXXC | Drain valve is opened during cooking. |
| E67 | SYSTEM INTERFACE BOARD NOT CONFIGURED - CALL SERVICE | Controller is turned on when the SIB board is not configured. |
| E68 | OIB FUSE TRIPPED – CALL SERVICE | The VIB board OIB fuse has tripped and didn't reset. |

| Code | ERROR MESSAGE | EXPLANATION |
|------|---|--|
| E69 | RECIPES NOT AVAILABLE – CALL SERVICE | The controller has not been programmed with product recipes. Replace controller with factory programmed controller. |
| E70 | OQS TEMP HIGH | Oil temperature is too high for a valid OQS reading. Filter at a temperature between 300°F (149°C) and 375°F (191°C). |
| E71 | OQS TEMP LOW | Oil temperature is too low for a valid OQS reading. Filter at a temperature between 300°F (149°C) and 375°F (191°C). |
| E72 | TPM RANGE LOW | The TPM is too low for a valid OQS reading. This may also be seen with fresh new oil. The incorrect oil type may be selected in the setup menu. The sensor may not be calibrated for the oil type. See oil type chart in instruction document 8197316. If issue continues contact a FAS. |
| E73 | TPM RANGE HIGH | The TPM reading is too high for a valid OQS reading. Dispose the oil. |
| E74 | OQS ERROR | The OQS has an internal error. If issue continues contact a FAS. |
| E75 | OQS AIR ERROR | The OQS is detecting air in the oil. Check the O-rings and check/tighten prescreen filter to ensure no air is entering the OQS sensor. If issue continues contact a FAS. |
| E76 | OQS ERROR | The OQS sensor has a communication error. Check connections to the OQS sensor. Power cycle the entire fryer battery. If issue continues contact a FAS. |
| E82 | LOW OIL DETECTED | This is only visible in the cloud. It's not visible on the UI. The vat doesn't have enough oil to cover the AIF/ATO probes. Fill the vat with oil. |
| E83 | TOP OFF EMPTY | This is only visible in the cloud. It's not visible on the UI. The JIB is out of oil. Replace the JIB and top off the vat. |
| E85 | LEFT RETURN VALVE or LEFT VALVE NOT OPEN - FILTRATION AND TOP OFF DISABLED - CALL SERVICE | Left return valve was trying to open, and confirmation is missing |
| E86 | LEFT RETURN VALVE or LEFT VALVE NOT CLOSED - FILTRATION AND TOP OFF DISABLED - CALL SERVICE | Left Return valve was trying to close, and confirmation is missing |
| E87 | CENTRAL VALVE NOT OPEN - FILTRATION AND TOP OFF DISABLED - CALL SERVICE | Central Valve was trying to open, and confirmation is missing |
| E88 | CENTRAL VALVE NOT CLOSED - FILTRATION AND TOP OFF DISABLED - CALL SERVICE | Central Valve was trying to close, and confirmation is missing |
| E89 | RIGHT RETURN VALVE NOT OPEN - FILTRATION AND TOP OFF DISABLED - CALL SERVICE | Right return valve was trying to open, and confirmation is missing |
| E90 | RIGHT RETURN VALVE NOT CLOSED - FILTRATION AND TOP OFF DISABLED - CALL SERVICE | Right return valve was trying to close, and confirmation is missing |

6.2.6 OQS (Oil Quality Sensor) Problems

| Problem | Corrective Action |
|----------------------------------|---|
| No TPM results displayed. | <p>Check the following items and perform another OQS filter.</p> <ul style="list-style-type: none"> • Ensure the vat is at setpoint temperature. • Inspect the pre-screen filter and ensure it is screwed in tightly. • Inspect the O-rings on the filter pan and ensure they are both present and that they are not missing, cracked or worn. If so replace them. • Ensure the filter paper is not clogged and clean filter paper is used. Did the vat refill the first time for the previous filter? If not change the filter paper. |



THIS PAGE INTENTIONALLY LEFT BLANK



Welbilt offers fully-integrated kitchen systems. Welbilt's portfolio of award-winning brands includes Cleveland™, Convotherm®, Crystal Tips®, Dean®, Delfield®, Fabristeel®, Frymaster®, Garland®, Inducs®, Koldtech®, Kolpak®, Lincoln®, McCann's™, Merco®, Merrychef®, Multiplex®, RDI®, SerVend™, SunFire®, U.S. Range™, and WMaxx™. Supported by service brands: FitKitchen®, kitchen systems; and KitchenConnect®, cloud-based open platform.

Bringing innovation to the table • welbilt.com