



12V

CORDLESS AIR COMPRESSOR

20582



These instructions accompanying the product are the original instructions. This document is part of the product, keep it for the life of the product passing it on to any subsequent holder of the product. Read all these instructions before assembling, operating or maintaining this product.

This manual has been compiled by Draper Tools describing the purpose for which the product has been designed, and contains all the necessary information to ensure its correct and safe use. By following all the general safety instructions contained in this manual, it will ensure both product and operator safety, together with longer life of the product itself.

All photographs and drawings in this manual are supplied by Draper Tools to help illustrate the operation of the product.

Whilst every effort has been made to ensure the accuracy of information contained in this manual, the Draper Tools policy of continuous improvement determines the right to make modifications without prior warning.

1. TITLE PAGE

1.1 INTRODUCTION:

USER MANUAL FOR: 12V Cordless Air Compressor

Stock No: 20582

Part No: DA12/151

1.2 REVISIONS:

Date first published March 2018.

As our user manuals are continually updated, users should make sure that they use the very latest version.

Downloads are available from: <http://drapertools.com/manuals>

Draper Tools Limited

Hursley Road

Chandler's Ford

Eastleigh

Hampshire

SO53 1YF

UK

Website: drapertools.com

Product Helpline: +44 (0) 23 8049 4344

General Fax: +44 (0) 23 8026 0784

1.3 UNDERSTANDING THIS MANUALS SAFETY CONTENT:

WARNING! – Information that draws attention to the risk of injury or death.

CAUTION! – Information that draws attention to the risk of damage to the product or surroundings.

1.4 COPYRIGHT © NOTICE:

Copyright © Draper Tools Limited.

Permission is granted to reproduce this publication for personal and educational use only. Commercial copying, redistribution, hiring or lending is prohibited.

No part of this publication may be stored in a retrieval system or transmitted in any other form or means without written permission from Draper Tools Limited.

In all cases this copyright notice must remain intact.

2. CONTENTS

1. TITLE PAGE

1.1 INTRODUCTION.....	2
1.2 REVISION HISTORY	2
1.3 UNDERSTANDING THIS MANUAL	2
1.4 COPYRIGHT NOTICE	2

2. CONTENTS

2.1 CONTENTS	3
--------------------	---

3. GUARANTEE

3.1 GUARANTEE	4
---------------------	---

4. INTRODUCTION

4.1 SCOPE.....	5
4.2 SPECIFICATION	5
4.3 HANDLING AND STORAGE.....	5

5. HEALTH AND SAFETY INFORMATION

5.1 GENERAL SAFETY INSTRUCTIONS FOR POWER TOOL USE	
– 1) Work area safety	6
– 2) Electrical safety	6
– 3) Personal safety.....	6-7
– 4) Power tool use and care	7
– 5) Battery tool use and care	7
– 6) Service	7
5.2 GENERAL SAFETY INSTRUCTIONS FOR COMPRESSORS	8
5.3 ADDITIONAL SAFETY INSTRUCTIONS FOR YOUR 12V AIR COMPRESSOR.....	9
5.4 CONNECTION TO THE POWER SUPPLY	9

6. TECHNICAL DESCRIPTION

6.1 IDENTIFICATION	10
--------------------------	----

7. UNPACKING AND CHECKING

7.1 PACKAGING	11
7.2 WHAT'S IN THE BOX?	11

8. PREPARING THE COMPRESSOR

8.1 CHARGING THE BATTERY (230V MAINS)	12
8.2 CHARGING THE BATTERY (12V ADAPTOR/CHARGER).....	13

9. OPERATION

9.1 INFLATING TYRES.....	14
9.2 USING THE LAMP.....	15
9.3 INFLATING ITEMS WITH ADDITIONAL TIPS	15

10. TROUBLESHOOTING

10.1 TROUBLESHOOTING GUIDE.....	16
---------------------------------	----

11. DISPOSAL

11.1 DISPOSAL.....	17
11.2 BATTERY PACK DISPOSAL INFORMATION	17

12. EXPLANATION OF SYMBOLS

12.1 EXPLANATION OF SYMBOLS	18
-----------------------------------	----

DECLARATION OF CONFORMITY ENCLOSED

3. GUARANTEE

3.1 GUARANTEE

Draper tools have been carefully tested and inspected before shipment and are guaranteed to be free from defective materials and workmanship.

Should the tool develop a fault, please return the complete tool to your nearest distributor or contact:

Draper Tools Limited, Chandler's Ford, Eastleigh, Hampshire, SO53 1YF. England.

Telephone Sales Desk: (023) 8049 4333 or:

Product Helpline (023) 8049 4344.

A proof of purchase must be provided.

If upon inspection it is found that the fault occurring is due to defective materials or workmanship, repairs will be carried out free of charge. This guarantee period covering parts/labour is 12 months from the date of purchase except where tools are hired out when the guarantee period is 90 days from the date of purchase. The guarantee is extended to 24 months for parts only. This guarantee does not apply to normal wear and tear, nor does it cover any damage caused by misuse, careless or unsafe handling, alterations, accidents, or repairs attempted or made by any personnel other than the authorised Draper warranty repair agent.

Note: If the tool is found not to be within the terms of warranty, repairs and carriage charges will be quoted and made accordingly.

This guarantee applies in lieu of any other guarantee expressed or implied and variations of its terms are not authorised.

Your Draper guarantee is not effective unless you can produce upon request a dated receipt or invoice to verify your proof of purchase within the guarantee period.

Please note that this guarantee is an additional benefit and does not affect your statutory rights.

Draper Tools Limited.

4. INTRODUCTION

4.1 SCOPE

Multi-functional compressor with light for the inflating of tyres, dinghies and sports equipment. Incorrect use of this 12V Air Compressor may result in personal injury or property damage.

4.2 SPECIFICATION

Stock No.	20582
Part No.	DA12/151
Rated voltage	12V
Battery type	Li-ion - 1500mAh
Charging time	3 hours
Maximum current	10A
Maximum pressure	150PSI (10.3bar)
Recommended cycle time	15mins
Display unit.....	psi/bar/KPa
Power cable length	3.5M (approx.)
Hose length	150mm (approx.)
Weight (excluding accessories)	800g

4.3 HANDLING AND STORAGE

Care must still be taken when handling and lifting. Dropping this machine will have an effect on the accuracy and may also result in personal injury. This machine is not a toy and must be respected.

The environment will have a negative result on its operation if you are not careful. If the air is damp, components will rust. If the machine is unprotected from dust and debris; components will become clogged: And if not cleaned and maintained correctly or regularly the machine will not perform at its best.

5. HEALTH AND SAFETY INFORMATION

Have this tool repaired by a qualified person. This tool is designed to conform to the relevant international and local standards and as such should be maintained and repaired by someone qualified; using only original parts supplied by the manufacturer: This will ensure the tool remains safe to use.

5.1 GENERAL SAFETY INSTRUCTIONS FOR POWER TOOL USE

Warning: Read all safety warnings and all instructions. Failure to follow the warnings and instructions may result in electric shock, fire and/or serious injury.

Save all warnings and instructions for future reference.

The term “power tool” in the warnings refers to your mains operated (corded) power tool or battery-operated (cordless) power tool, in this case it refers to a lawn mower.

1) Work area safety

- a) Keep work area clean and well lit. Cluttered or dark areas invite accidents.
- b) Do not operate power tools in explosive atmospheres, such as in the presence flammable liquids, gases or dust. Power tools create sparks which may ignite the dust or fumes.
- c) Keep children and bystanders away while operating a power tool. Distractions can cause you to lose control.

2) Electrical safety

- a) Power tool plugs must match the outlet. Never modify the plug in any way. Do not use any adapter plugs with earthed (grounded) power tools. Unmodified plugs and matching outlets will reduce risk of electric shock.
- b) Avoid body contact with earthed or grounded surfaces such as pipes, radiators, ranges and refrigerators. There is an increased risk of electric shock if your body is earthed or grounded.
- c) Do not expose power tools to rain or wet conditions. Water entering a power tool will increase the risk of electric shock.
- d) Do not abuse the cord. Never use the cord for carrying, pulling or unplugging the power tool. Keep cord away from heat, oil, sharp edges or moving parts. Damaged or entangled cords increase the risk of electric shock.
- e) When operating a power tool outdoors, use an extension cord suitable for outdoor use. Use of a cord suitable for outdoor use reduces the risk of electric shock.
- f) If operating a power tool in a damp location is unavoidable, use a residual current device (RCD) protected supply. Use of an RCD reduces the risk of electric shock.

3) Personal safety

- a) Stay alert, watch what you are doing and use common sense when operating a power tool. Do not use a power tool while you are tired or under the influence of drugs, alcohol or medication. A moment of inattention while operating power tools may result in serious personal injury.
- b) Use personal protective equipment. Always wear eye protection. Protective equipment such as dust mask, non-skid safety shoes, hard hat, or hearing protection used for appropriate conditions will reduce personal injuries.
- c) Prevent unintentional starting. Ensure the switch is in the off position before connecting to power source and/or battery pack, picking up or carrying the tool. Carrying power tools with your finger on the switch or energising power tools that have the switch on invites accidents.
- d) Remove any adjusting key or wrench before turning the power tool on. A wrench or a key left attached to a rotating part of the power tool may result in personal injury.

5. HEALTH AND SAFETY INFORMATION

- e) Do not overreach. Keep proper footing and balance at all times. This enables better control of the power tool in unexpected situations.
- f) Dress properly. Do not wear loose clothing or jewellery. Keep your hair, clothing and gloves away from moving parts. Loose clothes, jewellery or long hair can be caught in moving parts.
- g) If devices are provided for the connection of dust extraction and collection facilities, ensure these are connected and properly used. Use of these devices can reduce dust-related hazards.

4) Power tool use and care

- a) Do not force the power tool. Use the correct power tool for your application. The correct power tool will do the job better and safer at the rate for which it was designed.
- b) Do not use the power tool if the switch does not turn it on and off. Any power tool that cannot be controlled with the switch is dangerous and must be repaired.
- c) Disconnect the plug from the power source and/or battery pack from the power tool before making any adjustments, changing accessories, or storing power tools. Such preventive safety measures reduce the risk of starting the power tool accidentally.
- d) Store idle power tools out of the reach of children and do not allow persons unfamiliar with the power tool or these instructions to operate the power tool. Power tools are dangerous in the hands of untrained users.
- e) Maintain power tools. Check for misalignment or binding of moving parts, breakage of parts and any other condition that may affect the power tool's operation. If damaged, have the power tool repaired before use. Many accidents are caused by poorly maintained power tools.
- f) Keep cutting tools sharp and clean. Properly maintained cutting tools with sharp cutting edges are less likely to bind and are easier to control.
- g) Use the power tool, accessories and tool bits etc. in accordance with these instructions, taking into account the working conditions and the work to be performed. Use of the power tool for operations different from those intended could result in a hazardous situation.

5) Battery tool use and care

- a. Recharge only with the charger specified by the manufacturer. A charger that is suitable for one type of battery pack may create a risk of fire when used with another battery pack.
- b. Use power tools only with specifically designated battery packs. Use of any other battery packs may create a risk of injury and fire.
- c. When battery pack is not in use, keep it away from other metal objects, like paper clips, coins, keys, nails, screws or other small metal objects, that can make a connection from one terminal to another. Shorting the battery terminals together may cause burns or a fire.
- d. Under abusive conditions, liquid may be ejected from the battery; avoid contact. If contact accidentally occurs, flush with water. If liquid contacts eyes, additionally seek medical help. Liquid ejected from the battery may cause irritation or burns.

6) Service

- a. Have your power tool serviced by a qualified repair person using only identical replacement parts. This will ensure that the safety of the power tool is maintained.

5. HEALTH AND SAFETY INFORMATION

5.2 GENERAL SAFETY INSTRUCTIONS FOR COMPRESSORS

Warning: Please read the following instructions carefully failure to do so could lead to serious personal injury.

Important: Draper Tools recommends that this compressor should not be modified or used for any application other than that for which it was designed. If you are unsure of it's relative applications do not hesitate to contact us in writing and we will advise you.

1. Know your compressor

Before operating the compressor, read and fully understand the starting, operating and stopping sections in this manual. Read all labels affixed to the compressor. Learn it's applications and limitations.

2. Servicing and maintenance

Do not service or maintain this compressor until you have read and understood the maintenance section of this manual.

3. Check damaged parts

Before further use of this compressor, parts that are damaged should be carefully checked to ensure that it will operate correctly and perform its intended function. Check for alignment of moving parts, breakage of parts and any other conditions that may effect its operation. A guard or other part that is damaged should be properly repaired or replaced.

4. Disconnect from power supply

Before servicing, maintaining or replacing damaged parts ALWAYS disconnect the compressor from the power supply.

5. Avoid dangerous environments

Do not use the compressor in damp or wet locations or expose it to rain. Keep the work area well lit. Provide adequate surrounding work space.

6. Avoid accidental starting

Ensure the switch on the compressor is in the "off" position before connecting to a power supply.

7. Never leave the compressor running unattended

Disconnect from the power supply. Do not leave the compressor until it comes to a complete stop.

8. Use Recommended Accessories

Only use the recommended adaptors as supplied.

9. Overheating

Operation over an extended period of time will overheat the unit and damage the compressor. When this occurs stop the unit immediately and do not restart until cool, approximately 20 minutes (depending on environmental conditions).

10. Keep children away

Ensure the compressor is stored out of reach of small children.

11. Tyre pressure

The gauge on the compressor is intended as a guide only. Tyre pressures should be regularly checked against a tyre pressure gauge manufactured to BS4613, such as Draper Stock No.26443.

Have this tool repaired by a qualified person. This tool is designed to conform to the relevant international and local standards and as such should be maintained and repaired by someone qualified; using only original parts supplied by the manufacturer: This will ensure the tool remains safe to use.

5. HEALTH AND SAFETY INFORMATION

5.3 ADDITIONAL SAFETY INSTRUCTIONS FOR YOUR 12V AIR COMPRESSOR

1. This product is designed for occasional use. Inflation over a long period may over heat and cause damage to this product and potential harm to user.
2. This product should not operate for more than 15 minutes at a time. After which it must be switched off for at least 15 minutes.
3. Inspect your 12V Air Compressor and battery before each use. If damaged parts are found, have this tool repaired by a qualified person.
4. Never expose the compressor or battery to rain, frost or temperatures above 50°C.
5. Never use the compressor near flammable fluids or gasses. Make sure your area is well lit.
6. Protect yourself against electric shock. Avoid contact with grounded surfaces such as pipes, radiators, electric stoves, refrigerators etc.
7. Never leave children unattended with this compressor.
8. Never allow anyone to pump air into any body parts of people or animals. This air compressor is not a toy.

5.4 CONNECTION TO THE POWER SUPPLY

Make sure the power supply information on the machine's rating plate is compatible with the power supply you intend to connect it to.

This product comes supplied with a UK standard 3 pin plug fitted. It is designed for connection to a domestic power supply rated at 230V AC.

This appliance is Class II† and is designed for connection to a power supply matching that detailed on the rating label and compatible with the plug fitted.

If using an extension lead, follow the instructions that came with your lead regarding maximum load while cable is wound, if in doubt ensure that the entire cable is unwound. Using a coiled extension lead will generate heat which could melt the lead and cause a fire.

†Double insulated : This product requires no earth connection as supplementary insulation is applied to the basic insulation to protect against electric shock in the event of failure of the basic insulation.

Apart from replacing the fuse in the plug, no other electrical work is recommended on this machine.

6. TECHNICAL DESCRIPTION

6.1 IDENTIFICATION



- ① SMD LED emergency light on/off switch.
- ② SMD LED emergency light
- ③ Attachment lock.
- ④ Pressure display.
- ⑤ Trigger.
- ⑥ Trigger lock.
- ⑦ Battery release button.

7. UNPACKING AND CHECKING

7.1 PACKAGING

Carefully remove the machine from the packaging and examine it for any sign of damage that may have happened during shipping. Lay the contents out and check them against the parts shown below. If any part is damaged or missing; please contact the Draper Helpline (the telephone number appears on the Title page) and do not attempt to use the machine.

The packaging material should be retained at least during the guarantee period: in case the machine needs to be returned for repair.

Warning! Some of the packaging materials used may be harmful to children. Do not leave any of these materials in the reach of children.

If any of the packaging is to be thrown away, make sure they are disposed of correctly; according to local regulations.

7.2 WHAT'S IN THE BOX?

The packaging contains several parts and semi-assembled elements that require final assembly. Lay out the contents and check off the items against those featured below.

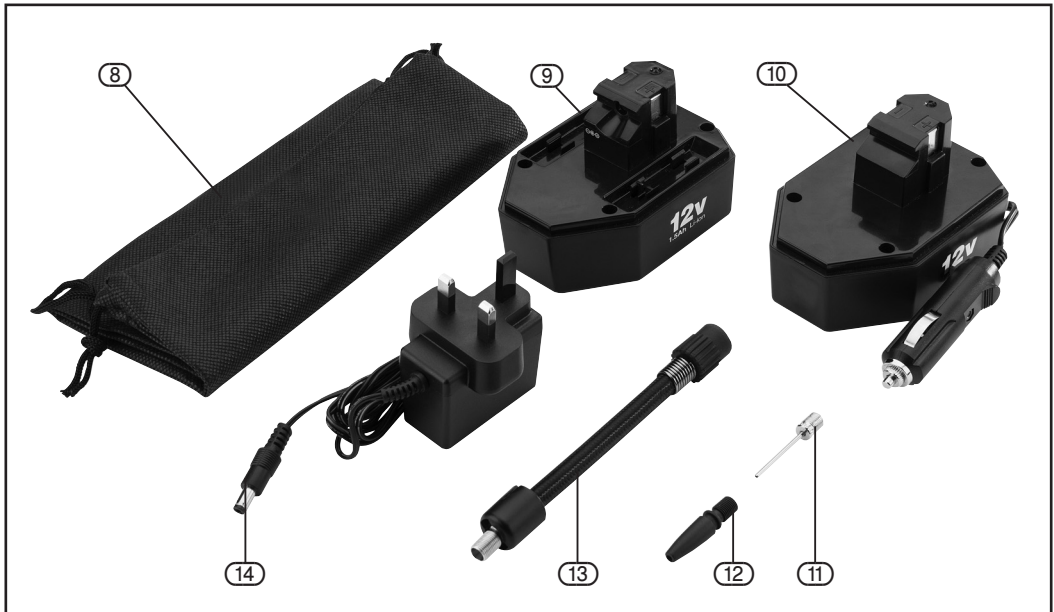

- ⑧ Storage bag.
- ⑨ 12V battery pack.
- ⑩ 12V Adaptor charger.
- ⑪ Needle adaptor.
- ⑫ Inflating adaptor.
- ⑬ Air hose.
- ⑭ 230V adaptor.

8. PREPARING THE COMPRESSOR

8.1 CHARGING THE BATTERY (230V MAINS) - FIGS. 1 & 2

Important: Charge for at least 3 hours before first use.

Do NOT store battery inside unit when not in use.

1. Remove the battery from the compressor by pressing locking tab (6) and pulling battery downwards.

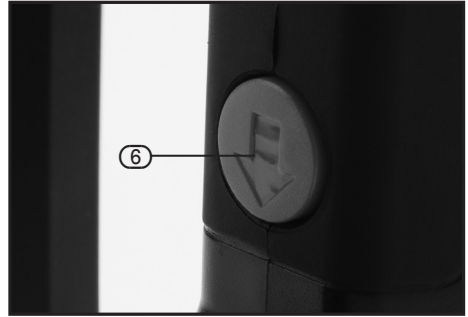

FIG.1

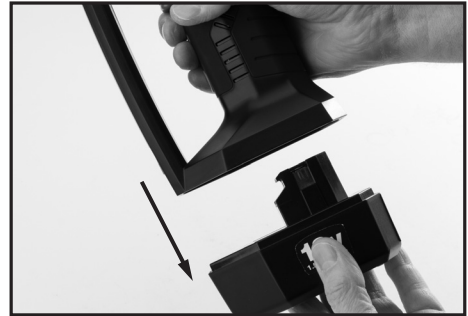

FIG.2

2. Plug the 3 pin plug into a 230V mains socket then connect the charger port to the battery (fig. 3). The LED on the plug will illuminate red.
3. When LED on charger changes from red to green, charging is finished. This may take up to 3 hour. Unit should run for approximately 15 minutes per charge.

Note: We recommend not charging the battery for more than 5 hours.

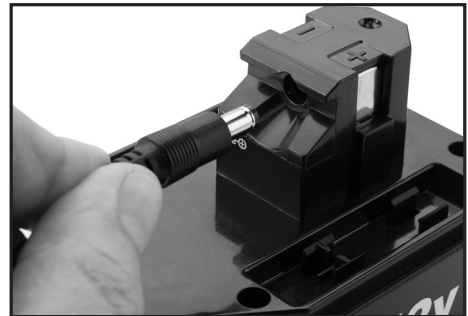

FIG.3

Note:

1. Typical run-time will vary depending on the battery level, pressure load during use, and the operating conditions.
2. High-pressure loading, or excessive back pressure will result in a shorter run-time than indicated.
3. Cold temperature conditions will reduce battery run-time. We recommend using the 12V DC Adaptor/Charger during cold temperature conditions.

8. PREPARING THE COMPRESSOR

8.2 CHARGING THE BATTERY (12V ADAPTOR/CHARGER)

1. Unravel cord before use.

Note: Be sure the cord runs through the hole at the base of the pack.

2. If the battery is installed, remove from compressor as detailed in 8.1.

3. Slide the 12V Adapter/Charger pack into compressor unit until it locks into place.

4. Connect the adapter into the DC socket in your car.
When ready to use, power car on. Always operate vehicle outdoors.

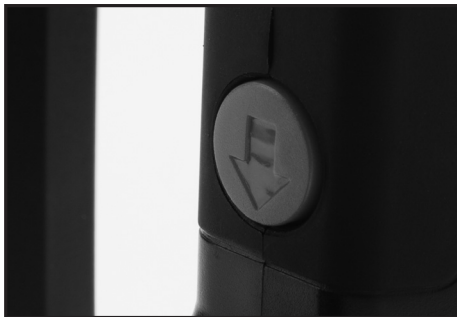

FIG.4



FIG.5

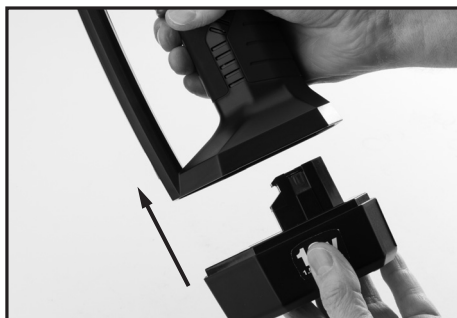

FIG.6

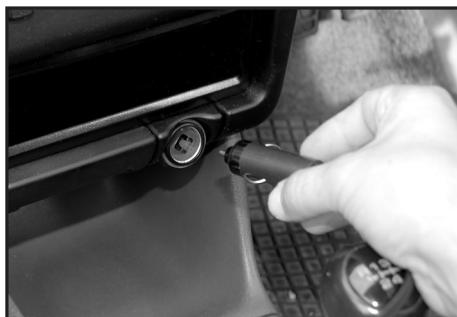

FIG.7

9. OPERATION

9.1 INFLATING TYRES

1. Loosen the attachment lock approximately 3 rotations anticlockwise. Do not remove lock completely.
2. **Important:** Insert the air hose with threaded connector into the attachment lock. Press in firmly while screwing in clockwise until it can go no further.
3. Tighten attachment lock clockwise until hand-tight to create an air tight seal around the thread.
4. Press the Power button below the LCD display to turn on.



FIG.8

Note: After 30 seconds of inactivity, the digital tyre gauge will turn off automatically to conserve energy.

5. To choose desired pressure format (PSI, BAR, KPA), press the power button continuously until desired format displays.
6. Screw the threaded connector onto tyre's valve stem. When connected, the gauge will show current tyre pressure.
7. Press "+" or "-" to set desired pressure level. Once set, wait a few seconds until current tyre pressure displays.

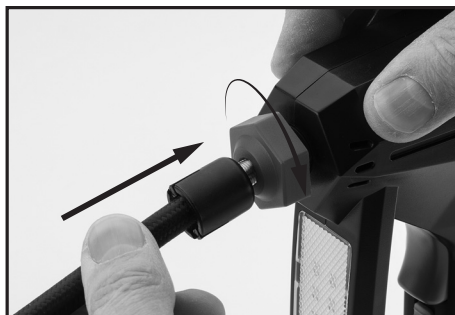

FIG.9

Note: Always check and follow the manufacturer's recommended pressure, usually located on the inside of the vehicles door.

8. Ensure trigger lock is in unlock position, press the trigger.
9. The compressor will begin to inflate the tyre to the set pressure level, and shut off automatically when reached.



FIG.10

10. When done, press the trigger once to turn off, and slide trigger lock to lock position.
11. Remove the thread connector from the tyre quickly, and replace valve stem cap on tyre, if required.

Note: Tyre pressures should be checked with a tyre pressure gauge to BSEN12645:1999.

Warning: Connector may be hot. Use caution when removing.

Note: To avoid over-inflation of tyres, please check the recommended tyre pressure in the vehicle's owner's manual.

For bicycle tyres, check markings on tyre.

Warning: The LCD display must turn on before operating air inflater.

Use a separate pressure gauge for more accurate reading.

9. OPERATION

9.2 USING THE LAMP

1. To switch the lamp on, press ① once to activate the 18 white SMD LED's.
Press ① again to activate the 18 red SMD LED's.
Press ① once more to activate the 18 red SMD LED's in SOS form.
To switch all lights off, press ① once again.

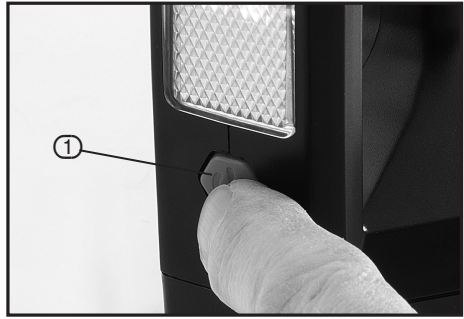

FIG.11

9.3 INFLATING ITEMS WITH ADDITIONAL TIPS

1. Insert one of the additional nozzles into threaded end of the air hose and screw in hand tight.
Operate the compressor as described in 8.1.



FIG.12

10. TROUBLESHOOTING

10.1 TROUBLESHOOTING GUIDE

Fault	Possible Causes	Remedy
Will not charge.	<ol style="list-style-type: none">1a. Poor connection between plug and 230V socket.1b. Poor connection between plug and 12V DC socket.2. Power supply fuse blown.	<ol style="list-style-type: none">1a. Check connection.1b. Check connection.2. Check cigarette lighter power supply fuse.
Runs but does not inflate.	<ol style="list-style-type: none">1. Poor connection onto the valve.2. Air escaping.	<ol style="list-style-type: none">1. Ensure the adaptor is pushed firmly onto the valve before locking into place.2a. Check the item for leaks.2b. Ensure hose has no breaks or leaks at the fitting.
Runs slowly.	<ol style="list-style-type: none">1. Overheating.2. Voltage too low.	<ol style="list-style-type: none">1. Unplug from power supply and leave to cool for approx. 30minutes.2. Check condition of battery.

11. DISPOSAL

11.1 DISPOSAL

- At the end of the machine's working life, or when it can no longer be repaired, ensure that it is disposed of according to national regulations.
- Contact your local authority for details of collection schemes in your area.

In all circumstances:

- Do not dispose of power tools with domestic waste.
- Do not incinerate.
- Do not dispose of WEEE* as unsorted municipal waste.



* Waste Electrical & Electronic Equipment.

11.2 BATTERY PACK DISPOSAL INFORMATION

Warning!

- Do not put battery pack in fire or mutilate – cells may burst or release toxic materials.
- Do not short circuit cells, may cause burns.
- The battery pack must be removed from the appliance before it is scrapped.
- The battery pack is to be disposed of safely.
- Do not mutilate batteries, corrosive electrolyte will be released.
- Do not dispose of batteries or cells in a charged condition.

Expired batteries must be recycled/disposed of in accordance with the appropriate regulation or legislation. They should be returned to your local warranty agent/stockist.

12. EXPLANATION OF SYMBOLS

12.1 EXPLANATION OF SYMBOLS



Read the instruction manual.



Class II construction
(Double insulated).



WEEE –
Waste Electrical &
Electronic Equipment.
*Do not dispose of Waste Electrical
& Electronic Equipment in with
domestic rubbish.*



Lithium-ion product.

Li-ion



Do not incinerate or
throw onto fire.



For indoor use only.
Do not expose to rain.



Fuse.



Polarity indication.



Rated voltage.

CONTACTS

Draper Tools Limited, Hursley Road,
Chandler's Ford, Eastleigh, Hampshire. SO53 1YF. U.K.

Helpline: (023) 8049 4344

Sales Desk: (023) 8049 4333

Internet: drapertools.com

E-mail: sales@drapertools.com

General Enquiries: (023) 8026 6355

Service/Warranty Repair Agent:

For aftersales servicing or warranty repairs, please contact the
Draper Tools Helpline for details of an agent in your local area.

YOUR DRAPER STOCKIST

RWKC0418

©Published by Draper Tools Limited.

No part of this publication may be reproduced, stored in a retrieval system or transmitted in any form or by any means, electronic, mechanical photocopying, recording or otherwise without prior permission in writing from Draper Tools Ltd.