

Operating and installation instructions SmartLine induction wok

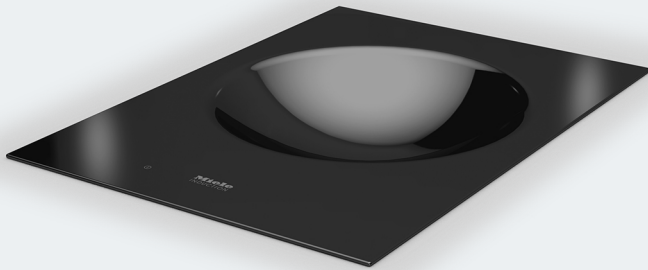

To avoid the risk of accidents or damage to the appliance it is **essential** to read these instructions before it is installed and used for the first time.

Warning and Safety instructions	5
Caring for the environment	15
Guide to the appliance	16
Wok	16
Controls and display	17
Cooking zones.....	18
Accessories supplied	19
How it works	20
Pans	21
Before using for the first time	22
Cleaning the SmartLine element for the first time.....	22
Switching on the SmartLine element for the first time.....	22
Operation	23
Using the appliance.....	23
Switching on the wok.....	24
Setting the power level.....	24
Switching off.....	24
Residual heat indicator.....	24
Power level setting - Extended setting range.....	24
Auto heat-up	25
Booster	26
Keeping warm	27
Setting ranges	28
Timer	29
Minute minder	29
Auto switch off	30
Using both timer functions at the same time	31
Additional functions	32
Stop & Go.....	32
Recall.....	32
Wipe protection	33
Demonstration mode.....	33
Displaying the SmartLine element data	33
Safety features	34
System lock/safety lock	34
Safety switch-off	35

Contents

Overheating protection.....	36
Programming	37
Cleaning and care	40
Problem solving guide	42
Messages in the display	42
Unexpected behaviour	44
General problems or technical faults.....	45
Optional accessories	46
After sales service	47
Contact in the event of a fault	47
Data plate	47
Warranty	47
Installation	48
Safety instructions for installation	48
Safety distances.....	49
Installation notes – surface-mounted	53
Worktop cutout – surface-mounted	55
Spacer bars – surface-mounted.....	58
Installation dimensions – Surface-mounted	59
Installation – surface-mounted	60
Installation notes – flush-fit	62
Worktop cutout – flush-fit.....	64
Spacer bars – flush-fit	67
Installation dimensions – Flush-fit	68
Installation – flush-fit	69
Electrical connection	71

Warning and Safety instructions

This wok complies with all current local and national safety requirements. Inappropriate use can, however, lead to personal injury and material damage.

Read the operating and installation instructions carefully before using the wok. They contain important information on safety, installation, use and maintenance. This prevents both personal injury and damage to the wok.

In accordance with standard IEC 60335-1, Miele expressly and strongly advises that you read and follow the instructions in the chapter on installing the wok as well as the safety instructions and warnings.

Miele cannot be held liable for injury or damage caused by non-compliance with these instructions.

Keep these instructions in a safe place and pass them on to any future owner.

Warning and Safety instructions

Correct application

- ▶ This wok is designed for domestic use and for use in similar environments.
- ▶ This wok is not intended for outdoor use.
- ▶ This wok is intended for domestic use only to cook food and keep it warm. Any other use is not supported by the manufacturer and could be dangerous.
- ▶ This wok can only be used by people with reduced physical, sensory or mental capabilities or lack of experience and knowledge if they are supervised whilst using it. They may only use it unsupervised if they have been shown how to use it in a safe way and understand the hazards involved.

Safety with children

- ▶ Children under 8 years of age must be kept away from the wok unless they are constantly supervised.
- ▶ Children aged 8 and older may only use the wok without supervision if they have been shown how to use it in a safe manner. Children must be able to understand and recognise the possible dangers caused by incorrect operation.
- ▶ Children must not be allowed to clean the wok unsupervised.
- ▶ Please supervise children in the vicinity of the wok and do not let them play with it.
- ▶ The wok gets hot when in use and remains hot for a while after being switched off. Keep children well away from the appliance until it has cooled down and there is no danger of burning.
- ▶ **Danger of burning!**
Do not store anything which might arouse a child's interest in storage areas above or behind the wok. Otherwise they could be tempted into climbing onto the wok with the risk of burning themselves.
- ▶ Risk of burning and scalding. Place pots and pans on the cooking zone in such a way that children cannot pull them down and burn themselves.
- ▶ **Danger of suffocation!** Whilst playing, children may become entangled in packaging material (such as plastic wrapping) or pull it over their head with the risk of suffocation. Keep packaging material away from children.
- ▶ Activate the system lock to ensure that children cannot switch the wok on by mistake. Use the safety lock when the wok is in use to prevent children from altering the settings selected.

Warning and Safety instructions

Technical safety

- ▶ Unauthorised installation, maintenance and repairs can cause considerable danger for the user. Installation, maintenance and repairs must only be carried out by a Miele authorised technician.
- ▶ Damage to the wok can compromise your safety. Check the wok for visible signs of damage. Do not use a damaged wok.
- ▶ Temporary or permanent operation on an autonomous power supply system or a power supply system that is not synchronised with the mains power supply (e.g. island networks, back-up systems) is possible. A prerequisite for operation is that the power supply system complies with the specifications of EN 50160 or an equivalent standard.

The function and operation of the protective measures provided in the domestic electrical installation and in this Miele product must also be maintained in isolated operation or in operation that is not synchronised with the mains power supply, or these measures must be replaced by equivalent measures in the installation. As described, for example, in the current version of BS OHSAS 18001–2 ISO 45001.

▶ The electrical safety of this wok can only be guaranteed when correctly earthed. It is essential that this standard safety requirement is met. If in any doubt please have the electrical installation tested by a qualified electrician.

▶ Before connecting the wok to the mains supply, ensure that the connection data on the data plate (voltage and frequency) match the mains electricity supply.

This data must be checked before connecting the appliance. Consult a qualified electrician if in any doubt.

▶ Do not connect the wok to the mains electricity supply by a multi-socket unit or an extension lead. These do not guarantee the required safety of the appliance (fire hazard).

Warning and Safety instructions

- ▶ For safety reasons, this wok may only be used after it has been built in.
- ▶ This wok must not be used in a non-stationary location (e.g. on a ship).
- ▶ Never open the casing of the wok.
Touching or tampering with electrical connections or components and mechanical parts is highly dangerous to the user and can cause operational faults.
- ▶ While the wok is under warranty repairs should only be undertaken by a Miele authorised service technician. Otherwise the warranty is invalidated.
- ▶ Miele can only guarantee the safety of the appliance when genuine original Miele replacement parts are used. Faulty components must only be replaced by Miele spare parts.
- ▶ The wok is not intended for use with an external timer switch or a remote control system.
- ▶ If the plug is removed from the connection cable or if the cable is supplied without a plug, the wok must be connected to the electrical supply by a suitably qualified electrician.
- ▶ If the mains connection cable is damaged, it must be replaced with a special mains connection cable by a qualified electrician (see “Electrical connection” in the “Installation” chapter).
- ▶ During installation, maintenance and repair work, the wok must be completely disconnected from the mains electricity supply. It is only completely isolated from the electricity supply when:
 - The mains fuse is disconnected.
 - The screw-out fuse is removed (in countries where this is applicable).
 - The plug (if present) is removed from the socket. To do this, pull the plug and not the mains connection cable.

Warning and Safety instructions

▶ **Danger of electric shock!**

Do not use the wok if it is faulty, or if the ceramic surface is cracked, chipped or damaged in any way. If you detect a fault during use switch it off immediately. Disconnect the wok from the electrical supply. Contact Miele Service.

▶ If the wok is built in behind a furniture front (e.g. a door), do not close the furniture door while the wok is in use. Heat and moisture can build up behind the closed furniture door. This can result in damage to the wok, the housing unit and the floor. Do not close the furniture door until the residual heat indicators have gone out.

▶ In areas which may be subject to infestation by cockroaches or other vermin, pay particular attention to keeping the appliance and its surroundings clean at all times. Any damage caused by cockroaches or other vermin will not be covered by the warranty.

Correct use

- ▶ The wok gets hot when in use and remains hot for some time after being switched off. The risk of burning is present until the residual heat indicators have gone out.
- ▶ Overheated fat and oil can ignite and catch fire. Never leave the wok unattended. Do not attempt to extinguish burning oil or fat with water.
Switch the wok off and carefully smother the flames with a fire blanket or a damp tea towel.
- ▶ Do not leave the SmartLine element unattended whilst it is being used. It should be continually monitored whilst boiling and flash frying.
- ▶ Flames could set the grease filters of a cooker hood on fire. Do not flambé under a cooker hood.
- ▶ Spray canisters, aerosols and other inflammable substances can ignite when heated. Therefore do not store such items or substances in a drawer under the wok. Cutlery inserts must be heat-resistant.
- ▶ Do not heat an empty pan.
- ▶ Do not heat up food in closed containers e.g. tins or sealed jars on the wok, as pressure will build up in the container which could cause it to explode.
- ▶ Do not cover the wok, e.g. with a cover, a cloth or protective foil. The material could catch fire, shatter or melt if the appliance is switched on by mistake or if residual heat is still present.
- ▶ When the wok is switched on either deliberately or by mistake, or when there is residual heat present, there is the risk of any metal items left on the wok heating up. Other materials can melt or catch fire. Damp pan lids might adhere to the ceramic surface and be difficult to dislodge. Do not use the wok as a resting place for anything else. Always disconnect the wok from the power supply when you have finished using it.

Warning and Safety instructions

- ▶ You could burn yourself on the hot wok. Protect your hands with heat-resistant pot holders or gloves when using a hot wok. Do not let them get wet or damp. Heat transfers through damp and wet material more quickly with the risk of scalding or burning yourself.
- ▶ When using an electrical appliance, e.g. a hand-held food blender, near the wok, ensure that the cable of the electrical appliance cannot come into contact with the hot wok. The insulation on the cable could become damaged.
- ▶ Grains of salt, sugar and sand (e.g. from cleaning vegetables) can cause scratches if they get under pan bases. Make sure that the ceramic surface is clean before placing pans on it.
- ▶ Even a light object can cause damage in certain circumstances. Do not drop anything on the ceramic surface.
- ▶ Placing hot pans on the sensors and indicators could damage the electronics underneath. Do not place hot pans on the sensors or indicators.
- ▶ Do not allow solid or liquid sugar, or pieces of plastic or aluminium foil to get onto the wok when it is hot, as they can damage the ceramic surface when it cools down. If this should occur, switch off the wok immediately and scrape off all residues straight away using a scraper blade suitable for use on glass. Wear oven gloves when doing this. Allow the ceramic surface to cool down and then clean it with a suitable ceramic hob cleaning agent.
- ▶ Do not allow the wok pan to boil dry as this can damage the ceramic glass. Do not leave the wok unattended whilst it is being used.
- ▶ Because induction heating works so quickly, the base of the pan could heat up to the temperature at which oil or fat self-ignites within a very short time. Do not leave the wok unattended whilst it is being used.

Warning and Safety instructions

- ▶ Heat oil or fat for a maximum of one minute. Never use the Booster function to heat oil or fat.
- ▶ For people fitted with a heart pacemaker: please note that the area immediately surrounding the wok is electromagnetically charged. It is very unlikely to affect a pacemaker. However, if in any doubt, consult the manufacturer of the pacemaker or your doctor.
- ▶ To prevent damage to items which are susceptible to electromagnetic fields, e.g. credit cards, digital storage devices, pocket calculators, etc, do not leave them in the immediate vicinity of the wok.
- ▶ Metal objects stored in a drawer under the wok can become hot if the appliance is used intensively for a long time. Do not store any metal objects in a drawer directly under the wok.
- ▶ The wok is fitted with a cooling fan. If a drawer is fitted directly underneath the built-in wok, ensure that there is sufficient space between the drawer and its contents and the underside of the wok in order to ensure sufficient ventilation for the wok. Do not store pointed or small items or paper in the drawer. They could get in through the ventilation slots or be sucked into the casing by the fan and damage the fan or impair cooling.
- ▶ Only use the wok pan supplied with the appliance. For safety reasons, other wok pans must not be used. Danger of burning (see “Induction - Pans”).

Warning and Safety instructions

Cleaning and care

- ▶ Do not use a steam cleaning appliance to clean this wok. The steam could reach electrical components and cause a short circuit.
- ▶ If the wok is built-in above a pyrolytic oven or cooker, do not use it during a Pyrolytic cleaning programme as this could trigger the overheating protection device on the wok (see “Safety features” – “Overheating protection”).
- ▶ Miele will guarantee to supply functional spare parts for a minimum of 10 years and up to 15 years following the discontinuation of your CombiSet.

Disposal of the packing material

The packaging is designed to protect the appliance from damage during transportation. The packaging materials used are selected from materials which are environmentally friendly for disposal and should be recycled.

Recycling the packaging reduces the use of raw materials in the manufacturing process and also reduces the amount of waste in landfill sites.

Disposing of your old appliance

Electrical and electronic appliances often contain valuable materials. They also contain specific materials, compounds and components, which were essential for their correct function and safety. These could be hazardous to human health and to the environment if disposed of with your domestic waste or if handled incorrectly. Please do not, therefore, dispose of your old appliance with your household waste.



Please dispose of it at your local community waste collection / recycling centre for electrical and electronic appliances, or contact your dealer or Miele for advice. You are also responsible for deleting any personal data that may be stored on the appliance being disposed of. Please ensure that your old appliance poses no risk to children while being stored prior to disposal.

Guide to the appliance

Wok

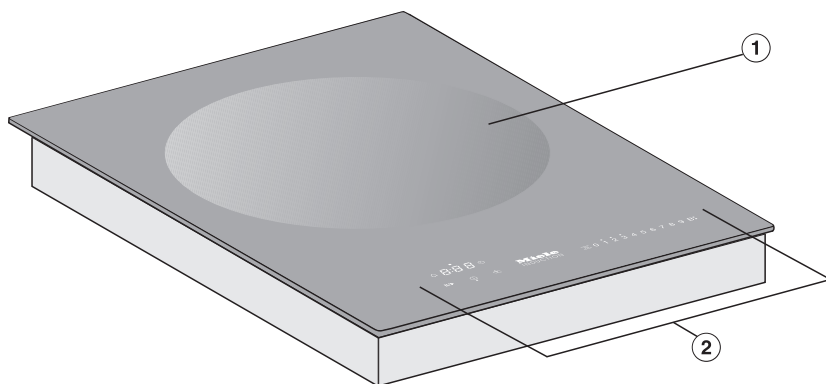

① Wok recess

② Controls and indicators

Controls and display

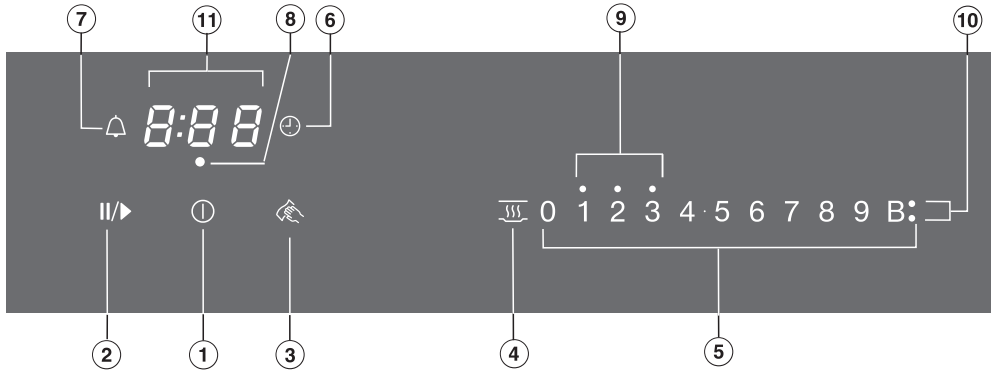

Sensor controls

- ① Wok On/Off
- ② Stop & Go
To stop/start a cooking process in progress
- ③ Wipe protection
To lock the sensor controls
- ④ Keeping warm
To activate/deactivate the Keeping warm function
- ⑤ Numerical display
 - To set the power level
 - To set the times
- ⑥ Auto switch off
Switches the wok off automatically
- ⑦ Minute minder

Guide to the appliance

Displays/indicator lights

- ⑧ Cooking zone allocation auto switch off
Auto switch off for the wok is activated
- ⑨ Residual heat
- ⑩ Booster function
Booster function is activated
- ⑪ Timer display

0:00 to Time

9:59

LOC System lock/safety lock is activated

dE Demo mode is activated

Cooking zones

Wok basin Ø in cm*	Rating in watts for 230 V**	
30.0	Normal	2400
	TwinBooster, level 1	2650
	TwinBooster, level 2	3000

Accessories supplied

The accessories supplied with your appliance as well as a range of optional ones are available to order from Miele (see “Optional accessories”).

Wok pan CSWP 1450



How it works

An induction coil is located underneath the induction wok. The coil creates a magnetic field that reacts directly with the base of the pan and heats it up. The wok recess itself is heated up indirectly by the heat given off by the wok pan.

Induction heating only works when the wok pan supplied is used.



Risk of burning due to hot items.

When the wok is switched on either deliberately or by mistake, or when there is residual heat present, there is the risk of any metal items left on the wok heating up.

Do not use the wok as a resting place for anything.

After use, switch the wok off with the

ⓘ sensor control.

Noises

The following noises might occur in the wok pan when the induction wok is in operation:

Buzzing on the higher power settings. This will decrease or cease altogether when the power setting is reduced.

You might hear a clicking sound from the electronic switches, especially on lower settings.

A whirring sound, when the cooling fan comes on. This switches on to protect the electronics when the wok is being used intensively. The cooling fan may continue to run after the appliance has been switched off.

 Risk of fire with unsuitable wok pans

If other wok pans are used, there is a risk of fat or food overheating and burning.

Only use the wok pan supplied with the appliance.

The wok pan supplied has been specially manufactured for use with this wok.

No cookware/unsuitable cookware display

The set power level flashes in the numerical display

- if the wok is switched on without the wok pan in place,
- if the wok pan is removed from the wok whilst it is switched on.

If the wok pan is placed on the wok recess within 3 minutes, the flashing power level will go out and you can continue as normal.

If the wok pan is not replaced, the wok will switch itself off automatically after 3 minutes.

Before using for the first time

- Please stick the extra data plate for the appliance supplied with this documentation in the space provided in the “After sales service” section of this booklet.
- Remove any protective wrapping and stickers.

Cleaning the SmartLine element for the first time

- Before using for the first use, clean the wok with a damp cloth only and then wipe dry.

Switching on the SmartLine element for the first time

The metal components have a protective coating. Smells and possibly some vapours may occur when the SmartLine element is used for the first time. The heating of the induction coils also causes odours in the first few hours of operation. With each subsequent use, the odour is reduced until it disappears completely.

The smell and any vapours given off do not indicate a faulty connection or appliance and they are not hazardous to health.

Please note that the heating up time on induction woks is very much shorter than on conventional woks.

Using the appliance

This SmartLine element is equipped with electronic sensor controls which react to finger contact. For safety reasons, in order to switch the appliance on, the On/Off ① sensor needs to be touched for a little longer than the other sensors.

Each time you touch a sensor, an audible tone sounds.

Only the printed On/Off ① symbol is visible when the SmartLine element is switched off. The other sensor controls light up when the SmartLine element is switched on.

 Malfunction due to dirty and/or covered sensor controls.

If the sensor controls are dirty or covered this could cause them to fail to react, to activate a function or even to switch the appliance off automatically (see “Safety features”, “Safety switch-off”). Placing hot pans on the sensor controls/indicators can damage the electronic unit underneath.

Keep the sensor controls and indicators clean and do not place anything on top of them. Do not place hot pans on them.

Operation

 Risk of fire with overheated food. Unattended food can overheat and catch alight. Do not leave the SmartLine element unattended whilst it is being used.

Please note that the heating-up time is very rapid with induction heating.

Switching on the wok

- Touch the ① sensor control.

Further sensor controls will light up.

If no further entry is made, the hob will switch itself off after a few seconds for safety reasons.

Setting the power level

Permanent pan recognition is activated as standard (see “Programming”). When the wok is switched on and you place a wok pan on it all the sensor controls for the numerical keybank will light up.

- Place the wok pan in position.
- Touch the appropriate number sensor control for the power level you want.

Switching off

- To switch off the wok basin, touch the 0 sensor control on the numerical keybank.
- To switch off the wok, touch the ① sensor control.

Residual heat indicator

If the SmartLine element is still hot, the residual heat indicator will light up after it has been switched off. Depending on the temperature, a dot will appear above power levels 1, 2 and 3.

The dots of the residual heat indicator go out one after the other as the SmartLine element cools down. The last dot only goes out when the SmartLine element is safe to touch.

 Danger of burning due to hot surfaces.

The surfaces will be hot after cooking.

Do not touch the surfaces while the residual heat indicators are on.

Power level setting - Extended setting range

- Touch the numerical keybank in between two number sensors.

The numbers to the left and right of the interim level light up brighter than the others.

Example:

If you have set power level 7, the numbers 7 and 8 will be brighter than the other numbers.

Auto heat-up

When Auto heat-up has been activated, the cooking zone switches on automatically at the highest setting and then switches to the continued cooking setting which you have previously selected. The heat-up time depends on which continued cooking setting has been chosen (see chart).

Activating Auto heat-up

- Touch the sensor for the continued cooking setting you want until a tone sounds and the sensor starts to pulsate.

During the heat-up time (see chart), the continued cooking level set will pulsate. With extended power levels (see “Programming”), the sensors for the power levels in front of and after the interim power level will pulsate if an extended power level setting has been selected.

Altering the continued cooking setting will deactivate Auto heat-up.

Deactivating Auto heat-up

- Touch the sensor for the continued cooking setting.
- or
- Set another power level.

Continued cooking setting*	Heat-up time [min : sec]
1	Approx. 0:15
1.	Approx. 0:15
2	Approx. 0:15
2.	Approx. 0:15
3	Approx. 0:25
3.	Approx. 0:25
4	Approx. 0:50
4.	Approx. 0:50
5	Approx. 2:00
5.	Approx. 5:50
6	Approx. 5:50
6.	Approx. 2:50
7	Approx. 2:50
7.	Approx. 2:50
8	Approx. 2:50
8.	Approx. 2:50
9	–

* The continued cooking settings with a dot after the number are only available if the power level range has been extended (see “Programming”).

Operation

Booster

The wok is equipped with a Twin-Booster.

When activated, the power is boosted for a maximum of 15 minutes.

If the Booster function is switched on when

- no power level has been selected, the cooking zone will revert automatically to level 9 at the end of the booster time or if the booster function is switched off before this.
- a power level has been selected, the cooking zone will revert automatically to the power level selected at the end of the booster time or if the booster function is switched off before this.

Activating TwinBooster, level 1

- Place the wok pan in position.
- Select a power level if necessary.
- Touch the **B** sensor control.

The indicator ● for TwinBooster level 1 lights up.

Activating TwinBooster, level 2

- Place the wok pan in position.
- Select a power level if necessary.
- Touch the **B** sensor control twice.

The indicator ●● for TwinBooster level 2 lights up.

Deactivating TwinBooster

- Touch the **B** sensor control repeatedly until the indicators go out.

or

- Set another power level.

Keeping warm

This function is for keeping food warm which has just been cooked and is still hot. It is not for reheating food that has gone cold.

The maximum duration for keeping food warm is 2 hours.

- Only use pans for keeping food warm. Cover the pan with a lid.
- Stir firm or viscous food (mashed potatoes, stew) occasionally.
- Nutrients are lost when food is cooked, and continue to diminish when food is kept warm. The longer food is kept warm, the greater the loss of nutrients. Try to ensure that food is kept warm for as short a time as possible.

Activating/deactivating the keeping warm function

- Touch the  sensor control.

Setting ranges

The hob is programmed with 9 power levels at the factory. If you wish to fine-tune a setting, you can extend the power level range to 17 power levels (see “Programming”).

	Setting range	
	Factory setting (9 power levels)	Extended setting (17 power levels)
Keeping food warm, melting chocolate	1–2	1–2.
Warming food up	3–6	3–5.
Stir-frying, e.g. Chinese dishes	7–9	7–9

These settings should only be taken as a guide. Cooking durations will vary according to the type, texture and thickness of the food being cooked.



The SmartLine element has to be switched on if you wish to use the timer.

The timer can be used for the following 2 functions:

- For setting the minute minder
- For automatically switching off a cooking zone/heater element/Tepan Yaki zone

You can use the functions simultaneously.

A duration of between 1 minute (0:01) and 9 hours 59 minutes (9:59) can be set.

Durations of up to 59 minutes are shown in minutes (0:59) and durations of more than 60 minutes are shown in hours and minutes. Durations are entered in the order of hours, followed by minutes in tens and then units.

Durations are entered using the numerical display.

Example:

59 minutes = 0:59 hours,

Enter: 5-9

80 minutes = 1:20 hours,

Enter: 1-2-0

After the first number has been entered, the timer display will light up constantly. After the second number has been entered, the first number will move to the left. After the third number has been entered, the first and second numbers will move to the left.

Minute minder

Setting the minute minder

- Touch the  sensor control.

The timer display flashes.

- Set the required duration.

Touch the  sensor control or wait 10 seconds to start the minute minder.

Changing the minute minder duration

- Touch the  sensor control.

The timer display flashes.

- Set the required duration.

Deleting the minute minder duration

- Touch the  sensor control.

- Touch the  on the numerical display.

Timer

Auto switch off

You can set a time after which a cooking zone will switch off automatically. This function can be used for all cooking zones at the same time.

If the time programmed is longer than the maximum operating time allowed, the cooking zone will be switched off by the safety switch-off function (see "Safety features – Safety switch-off").

Setting the switch-off time

- Select a power level for the cooking zone you require.
- Touch the  sensor control.

The timer display flashes.

- Set the required duration.

Touch the  sensor control or wait 10 seconds to start the switch-off time.

The cooking zone allocation auto switch off indicator light pulsates.

- To set a switch-off time for another cooking zone, follow the same steps as described above.

If more than one switch-off time is programmed, the shortest time left will be displayed, and the corresponding indicator light will pulsate. The other indicator lights will light up constantly.

- If you want to show the time left for other cooking zones in the background, touch the  sensor control of the desired cooking zone.

Changing the switch-off time

- Touch the  sensor control repeatedly until the indicator light for the cooking zone you require pulsates.

The timer display flashes.

- Set the required duration.

Deleting the switch-off time



- Touch the  sensor control repeatedly until the indicator light for the cooking zone you require pulsates.

The timer display flashes.

- Touch the  sensor control on the numerical display.

Using both timer functions at the same time

If you use both functions simultaneously, the shortest time is always displayed. The  sensor control (minute minder) or the indicator light of the cooking zone with the shortest time pulsates.

- Touch the  or  sensor control if you want to show the times left counting down in the background.
- If a switch-off time has been programmed for several cooking zones, touch the  sensor control repeatedly until the indicator light for the required cooking zone pulsates.

Additional functions

Stop & Go

The set power level is reduced to 1 when the Stop & Go function is activated.

The power levels and timer settings cannot be changed; the wok can only be switched off. The minute minder, switch-off, booster and AutoBoost times continue to run.

If the function is deactivated, the appliance switches back to the power level that was set last.

If the function is not deactivated within 1 hour, the wok will switch off.

Activating/Deactivating

- Touch the II/▶ sensor control.

Recall

If the SmartLine element is accidentally switched off during use, you can use this function to restore all the settings. The SmartLine element must be switched on again within 10 seconds.

- Switch the SmartLine element on again.

The previously set power levels flash.

- Press one of the flashing power level indicators immediately.

The appliance will continue to operate using the settings selected previously.

Wipe protection

You can lock the SmartLine element sensor controls for 20 seconds in order to remove soiling, for example. The ① sensor control is not locked.

Activating

- Touch the  sensor control.

The time counts down in the timer display.

Deactivating

- Touch the  sensor control until the timer display goes out.

Demonstration mode

This function enables the SmartLine element to be demonstrated in show-rooms without heating up.

Activating/deactivating demonstration mode

- Switch the SmartLine element on.
- Touch the 0 sensor on any of the numerical keybanks.
- Then touch the 0 and 2 sensors at the same time for 6 seconds.

In the timer display, *dE* flashes alternately with *0n* (demonstration mode activated) or *0FF* (demonstration mode deactivated) for a few seconds.

Displaying the SmartLine element data

The model designation and software version of the SmartLine element can be displayed. To do this there must not be any pots or pans on the SmartLine element.

Model designation

- Switch the SmartLine element on.
- Touch the 0 sensor control on any of the numerical keybanks.
- Then touch the 0 and 4 sensor controls at the same time.

The timer display shows 2 numbers flashing alternately:

12 flashes alternately with *34* = CS 1234

Software version

- Switch the SmartLine element on.
- Touch the 0 sensor control on any of the numerical keybanks.
- Then touch the 0 and 3 sensor controls at the same time.

Numbers will appear in the timer display:

2:00 = software version

Safety features

System lock/safety lock

The safety lock function is deactivated if there is a mains outage.

Your SmartLine element is equipped with a system lock and a safety lock to prevent the element from being switched on or any settings being altered by mistake.

The **system lock** is activated when the SmartLine element is switched off. If the system lock is activated, the element cannot be switched on and the timer cannot be used. A set minute minder time continues to count down. The SmartLine element is programmed so that the system lock must be activated manually. It can be programmed to be activated automatically 5 minutes after the SmartLine element has been switched off (see “Programming”).

The **safety lock** is activated when the SmartLine element is switched on. When the safety lock is activated, the element can be operated only under certain conditions:

- Selected power levels cannot be changed.
- A set minute minder time can be modified.
- The SmartLine element can only be switched off.

If an unavailable sensor control is touched whilst the system lock or safety lock is activated *LDC* will appear in the timer display for a few seconds and a tone will sound.

Activating the system lock

- Touch the  sensor for 6 seconds.



The seconds can be seen counting down in the timer display. When this time has elapsed *LDC* will appear in the timer display. The system lock has been activated.

Deactivating the system lock

- Touch the  sensor for 6 seconds.



LDC will appear briefly in the timer display and then the seconds will be seen counting down. The system lock is deactivated once the time has elapsed.

Activating the safety lock

- Touch and hold the  and  sensors at the same time for 6 seconds.

The seconds can be seen counting down in the timer display. When this time has elapsed *LDC* will appear in the timer display. The safety lock is activated.

Deactivating the safety lock

- Touch and hold the  and  sensors at the same time for 6 seconds.

LDC will appear briefly in the timer display and then the seconds will be seen counting down. Once the time has elapsed, the lock function is deactivated.

Safety switch-off

Sensor controls are covered

Your SmartLine element will turn off automatically if one or several of the sensor controls remain covered for longer than 10 seconds, for example, by finger contact, food boiling over or by an object such as an oven glove or tea towel. ① flashes briefly above the \mathcal{L} sensor control and a tone will sound. If you remove the obstruction and/or clean the appliance, \mathcal{L} goes out and the SmartLine element is ready for use again.

Excessive operating time

The safety shut-off is triggered automatically if the wok basin has been heated for an unusually long period of time. This time depends on the power level selected. If it has been exceeded, the wok basin turns off and the residual heat indicator appears. The wok can now be used again as normal.

The SmartLine element is programmed to safety setting 0 at the factory. If required you can set a higher safety setting with a shorter maximum operating time (see chart).

Power level*	Maximum operating time [h:min]		
	Safety setting		
	0**	1	2
1	10:00	8:00	5:00
1.	10:00	7:00	4:00
2/2.	5:00	4:00	3:00
3/3.	5:00	3:30	2:00
4/4.	4:00	2:00	1:30
5/5.	4:00	1:30	1:00
6/6.	4:00	1:00	0:30
7/7.	4:00	0:42	0:24
8	4:00	0:30	0:20
8.	4:00	0:30	0:18
9	1:00	0:24	0:10

* The power levels with a dot after the number are only available if the power level range has been extended (see “Setting range”).

** Factory default setting

Safety features

Overheating protection

All the induction coils and cooling elements for the electronics are fitted with an overheating protection mechanism. Before the induction coils and/or cooling elements get too hot, the overheating protection mechanism cuts in in one of the following ways:

Induction coils

- Any Booster function in operation will be switched off.
- The set power level will be reduced.
- The cooking zone turns off automatically. *Err* will flash alternately with *044* in the timer display.

You can use the cooking zone again as usual when the fault code has gone out.

Cooling elements

- Any Booster function in operation will be switched off.
- The set power level will be reduced.
- The cooking zones switch off automatically.

The affected cooking zones can only be used again as usual once the cooling element has cooled down to a safe level.

The overheating protection may be activated under the following circumstances:

- The pan being heated is empty.
- Fat or oil is being heated on a high power level.
- There is insufficient ventilation to the underside of the hob.
- A hot cooking zone is switched on after an interruption to the power supply.



If, despite removing the cause, the overheating protection mechanism triggers again, contact the Customer Service Department.

You can adapt the programming of the SmartLine element to your personal needs. Several settings can be altered in succession.

After accessing the programming mode, the  symbol and *PC* will appear in the timer display. After a few seconds *P:01* (programme 01) will flash alternately with *C:01* (code) in the timer display.

Changing the programming

Accessing programming mode

- **With the SmartLine element switched off**, press and hold the  and  sensor controls together until the  symbol lights up and *PC* is shown in the timer display.

Setting the programme

For a two-digit programme number you need to first set the tens position.

- Touch the  sensor control repeatedly until the programme number you want appears in the display, or touch the appropriate number on the numerical display.

Setting the code

- Touch the  sensor control repeatedly until the code number you want appears in the display, or touch the appropriate number on the numerical display.

Saving the settings

- While the programme is showing in the display (e.g. *P:01*) touch the  sensor control until the indicators go out.

To avoid saving the settings

- Touch the  sensor control until the indicators go out.

Programming

Programme ¹		Code ²	Settings
P:01	Demo mode	C:00	Demo mode off
		C:01	Demo mode on ³
P:03	Factory default setting	C:00	Do not restore factory default settings
		C:01	Restore factory default settings
P:04	Number of cooking zone power levels	C:00	9 power levels + Booster
		C:01	17 power levels + Booster ⁴
P:06	Audible tone when a sensor control is touched	C:00	Off ⁵
		C:01	Quiet
		C:02	Medium
		C:03	Loud
P:07	Timer buzzer	C:00	Off
		C:01	Quiet
		C:02	Medium
		C:03	Loud
P:08	System lock	C:00	System lock can only be activated manually
		C:01	System lock activated automatically
P:09	Maximum operating time	C:00	Safety setting 0
		C:01	Safety setting 1
		C:02	Safety setting 2

Programme ¹		Code ²	Settings
P:12	Sensor controls reaction speed	C:00	Slow
		C:01	Normal
		C:02	Fast
P:15	Permanent pan recognition	C:00	Permanent pan recognition off
		C:01	Permanent pan recognition on

¹ Unlisted programmes are not assigned.

² The factory-set code is shown in bold.

³ After the hob has been switched on *dE* appears in the timer display for a few seconds.

⁴ In the text and charts, the extended power levels are shown with a dot after the number for better understanding.

⁵ The audible tone for the On/Off sensor control cannot be switched off.

Cleaning and care

 Danger of burning due to hot surfaces.

The surfaces will be hot after cooking.

Switch the wok off.

Allow the surfaces to cool down before cleaning the wok.

 Risk of damage due to moisture ingress.

The steam from a steam cleaning appliance could reach live electrical components and cause a short circuit.

Do not use a steam cleaner to clean the wok.

All surfaces could be discoloured or damaged if unsuitable cleaning agents are used. All surfaces are susceptible to scratching.

Remove all cleaning agent residues immediately.

Never use abrasive sponges or cleaning agents.

Allow the SmartLine element to cool down before cleaning.

- Clean the SmartLine element and accessories after each use.
- Dry the SmartLine element thoroughly after every cleaning to avoid limescale residue.

Unsuitable cleaning agents

To avoid damaging the surfaces of the appliance, do not use:

- washing-up liquid
- cleaning agents containing soda, alkalines, ammonia, acids or chlorides
- cleaning agents containing descaling agents
- stain and rust removers
- abrasive cleaning agents, e.g. powder cleaners and cream cleaners
- solvent-based cleaning agents
- dishwasher cleaner
- oven sprays
- glass cleaning agents
- hard, abrasive brushes or sponges (e.g. pot scourers) or sponges which have been previously used and still contain abrasive cleaning agents
- melamine eraser blocks

 Risk of damage by pointed objects.

The seal between the SmartLine element and the worktop could suffer damage.

Do not use pointed objects for cleaning.

Not all soiling and residues can be removed using a solution of washing-up liquid.

An invisible film can develop that can lead to discolouration of the glass ceramic surface. This discolouration cannot be removed.

Clean the ceramic surface regularly with a proprietary ceramic glass cleaning agent.

- Remove any coarse soiling with a damp cloth and more stubborn soiling with a shielded scraper blade suitable for use on glass.
- Then clean the ceramic glass surface with the Miele ceramic and stainless steel hob cleaner (see “optional accessories”) or with a proprietary ceramic glass cleaner applied with kitchen paper or a clean cloth. Do not apply the cleaner while the hob is still hot, as this can result in marking. Please follow the cleaning agent manufacturer's instructions.
- Finally wipe the glass ceramic surface with a damp cloth and polish with a soft, dry cloth.

Residues can burn onto the hob the next time it is used and cause damage to the glass ceramic surface. Ensure that all cleaning agent residues are removed.

- **Spots** caused by limescale, water and aluminium residues (spots with a metallic appearance) can be removed using Miele's ceramic and stainless steel hob cleaner.

 Danger of burning due to hot surfaces.

The surfaces get hot during cooking. Wear oven gloves when removing residues of sugar, plastic or aluminium foil from a hot ceramic surface with a shielded scraper blade.

- Should any **sugar, plastic or aluminium foil** spill or fall onto the hot ceramic surface while it is in use, switch off the cooking zone.
- Then carefully scrape off these residues **immediately** whilst they are still hot, using a scraper blade suitable for use on glass.
- Afterwards, clean the ceramic surface in its cooled state, as described above.

Problem solving guide

Many malfunctions and faults that can occur in daily operation can be easily remedied. Time and money will be saved because a service call will not be needed.

The following guide may help you to find the reason for a malfunction or a fault, and to correct it.

Messages in the display

Problem	Cause and remedy
After the SmartLine element has been switched on or a sensor control has been touched, <i>LDC</i> appears in the timer display for a few seconds.	The system lock or safety lock is activated. ■ Deactivate the system lock or safety lock (see “System lock / Safety lock”).
After the SmartLine element has been switched on <i>dE</i> appears in the timer display for a short while. The SmartLine element does not heat up.	The SmartLine element is in demonstration mode. ■ Touch the 0 and 2 sensor controls at the same time until <i>dE</i> flashes alternately with <i>OFF</i> in the timer display.
The SmartLine element has switched off automatically. When the element is switched back on, <i>L</i> appears above the On/Off sensor control ①.	One or more of the sensor controls are covered, e.g. by finger contact, food boiling over or an object. ■ Clean off any dirt and/or remove the object (see “Safety features” – “Safety switch-off”).
<i>Err</i> flashes alternately with <i>30</i> in the timer display and a tone will sound.	The SmartLine element is connected incorrectly. ■ Disconnect the SmartLine element from the mains. ■ Contact Miele Service.
<i>Err</i> will flash alternately with <i>044</i> in the timer display.	The overheating protection mechanism has been activated. ■ See “Safety features – Overheating protection”.

Problem solving guide

Problem	Cause and remedy
<i>Err</i> will flash alternately with 047, 048 or 049 in the timer display.	The fan is blocked or defective. <ul style="list-style-type: none">■ Make sure it has not been blocked by an object.■ Remove the obstruction.■ If this fault message continues to appear in the display, contact the Customer Service Department.
A message not listed in this table is appearing in the timer display.	There is an electronic module fault. <ul style="list-style-type: none">■ Interrupt the power supply to the SmartLine element for approx. 1 minute.■ If the problem persists after power has been restored, please contact the Customer Service Department.

Problem solving guide

Unexpected behaviour

Problem	Cause and remedy
The power level selected is flashing.	The wok pan is not in position. ■ Place the wok pan in position.
The sensor controls show increased sensitivity or fail to react.	The sensitivity level of the sensor controls has changed. ■ Make sure that there is no direct light (from the sun or from an artificial source) falling onto the SmartLine element. The area surrounding the SmartLine element must not be too dark. ■ Take any pans off the SmartLine element and wipe away any food deposits. Ensure that there is nothing covering the entire SmartLine element unit or sensor controls. ■ Interrupt the power supply to the SmartLine element for approx. 1 minute. ■ If the problem persists after power has been restored, please contact Miele Service.
The wok has switched itself off automatically.	It has been operated for too long. ■ Switch the wok back on again (see “Safety features” – “Safety switch off”).
	The overheating protection mechanism has been activated. ■ See “Safety features” – “Overheating protection”.
The cooking zone is not working in the usual way on the power setting selected.	The overheating protection mechanism has been activated. ■ See “Safety features”.
The Booster has deactivated early automatically.	The overheating protection mechanism has been activated. ■ See “Safety features”.

General problems or technical faults

Problem	Cause and remedy
<p>The SmartLine element cannot be switched on.</p>	<p>There is no power to the SmartLine element.</p> <ul style="list-style-type: none"> ■ Check whether the mains fuse has tripped. Contact an electrician or Miele Service (for the minimum fuse rating, see data plate).
	<p>There may be a technical fault.</p> <ul style="list-style-type: none"> ■ Disconnect the SmartLine element from the mains electricity supply for approx. 1 minute by <ul style="list-style-type: none"> – tripping the relevant mains fuse or screwing the fuse out completely, or – switching off the residual current protection device. ■ If, after resetting the trip switch in the mains fuse box or the residual current protection device, the SmartLine element will still not switch on, contact a qualified electrician or Miele Service.
<p>A smell and vapours are given off when the new wok is being used.</p>	<p>The metal components have a protective coating. When the wok is used for the first time, this causes a smell and possibly also vapour. The material from which the induction coils are made also gives off a smell in the first few hours of operation. With each subsequent use, the odour is reduced until it disappears completely. The smell and any vapours given off do not indicate a faulty connection or appliance and they are not hazardous to health.</p>
<p>An operating noise can be heard after the SmartLine element has been switched off.</p>	<p>The cooling fan runs until the SmartLine element has cooled down and then switches off automatically.</p>

Optional accessories

Miele offer a comprehensive range of useful accessories as well as cleaning and conditioning products for your Miele appliances.

These products can be ordered through the Miele Webshop.

They can also be ordered from Miele (see end of this booklet for contact details) or from your Miele dealer.

Wok pan CSWP 1450



Cleaning and care products

Ceramic and stainless steel hob cleaner 250 ml



Removes heavy soiling, limescale deposits and aluminium residues

Microfibre cloth

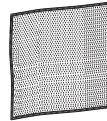

Removes finger marks and light soiling

Contact in the event of a fault

In the event of any faults which you cannot remedy yourself, please contact your Miele dealer or the Miele Customer Service Department.

You can book a Miele Customer Service Department call-out online at www.miele.com/service.

Contact information for the Miele Customer Service Department can be found at the end of this document.

Please quote the model identifier and serial number of your appliance (Fabr./SN/ Nr.) when contacting the Miele Customer Service Department. This information can be found on the data plate.

Please note that telephone calls may be monitored and recorded for training purposes and that a call-out charge will be applied to service visits where the problem could have been resolved as described in this booklet.

Data plate

Stick the extra data plate supplied with the appliance here. Make sure that the model number matches the one specified on the back cover of this document.

Warranty

For information on the appliance warranty specific to your country please contact Miele. See back cover for address.

In the UK, your appliance warranty is valid for 2 years from the date of purchase. However, you must activate your cover by calling 0330 160 6640 or registering online at www.miele.co.uk.

Installation

Safety instructions for installation



Damage risk from incorrect installation.

Incorrect installation can cause damage to the SmartLine element.

The SmartLine element must only be installed by a qualified person.



Risk of electric shock!

Incorrect connection to the mains supply may result in an electric shock.

The SmartLine element must be connected to the electrical supply by a qualified person only.



Damage from falling objects.

Take care not to damage the SmartLine element when fitting wall units or a cooker hood above it.

Fit the wall units and the cooker hood before the SmartLine element.

- ▶ The veneer or laminate coatings of worktops (or adjacent kitchen units) must be treated with 100 °C heat-resistant adhesive which will not dissolve or distort. Any backmoulds must be of heat-resistant material.
- ▶ The SmartLine element must not be installed over a fridge, fridge-freezer, freezer, dishwasher, washing machine, washer-dryer or tumble dryer.
- ▶ This SmartLine element must not be installed above ovens or cookers unless these have a built-in cooling down fan.
- ▶ After installation, the mains connection cable of the SmartLine element must not come into contact with any moving kitchen component (e.g. a drawer) or be subject to mechanical loads which could damage it.
- ▶ Observe carefully the safety clearances listed on the following pages.

Safety distances

Safety distance above the SmartLine element

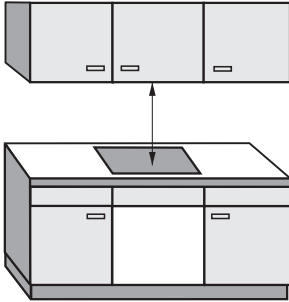

The safety distance specified by the manufacturer of the cooker hood must be maintained between the SmartLine element and the cooker hood above it.

If combustible objects are installed above the SmartLine element (e.g. cabinets, utensil rail, etc.), a minimum safety distance of 500 mm must be maintained.

When two or more SmartLine elements which have different safety distances are installed together below a cooker hood, you should observe the greatest specified safety distance.

Installation

Safety distances to the sides and back of the appliance

The SmartLine element should preferably be installed with plenty of space on the right and left.

The minimum distance ① specified below must be observed between the rear of the SmartLine element and a tall unit or room wall.

The minimum distance ②, ③ specified below must be adhered to between one side of the SmartLine element (right or left) and a tall unit or room wall. A minimum distance of 300 mm must be observed on the opposite side.

① Minimum distance between the **back** of the worktop cut-out and the rear edge of the worktop: 50 mm

② Minimum distance on the **right** side between the worktop cut-out and the closest adjacent piece of furniture (e.g. tall unit) or a room wall: 50 mm.

③ Minimum distance on the **left** side between the worktop cut-out and the closest adjacent piece of furniture (e.g. tall unit) or a room wall: 50 mm.

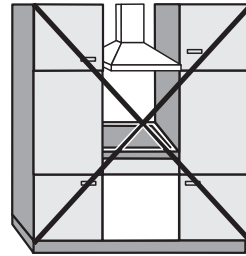

Not allowed

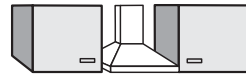

Highly recommended



Not recommended



Not recommended

Minimum safety distance underneath the SmartLine element

To ensure proper ventilation of the SmartLine element, a minimum safety distance is required between the element and an oven, interim shelf or drawer.

The minimum safety distance from the lower edge of the SmartLine element to

- Upper edge of oven: 15 mm
- Upper edge of interim shelf: 15 mm
- Upper edge of drawer: 5 mm
- Base of drawer: 75 mm

Intermediate shelf

It is not necessary to fit an interim shelf underneath the SmartLine element but one may be fitted if you wish.

Leave a gap of 10 mm at the back of the shelf to accommodate the mains connection cable. We recommend a gap at the front of the SmartLine element of 20 mm to ensure good ventilation.

Installation

Safety distance when installing the appliance near a wall with additional niche cladding

If a niche cladding is installed, a minimum safety distance must be maintained between the worktop cut-out and the cladding, since high temperatures can damage these materials.

If the niche cladding is made from a combustible material (e.g. wood) a minimum safety distance ⑤ of 50 mm must be maintained between the worktop cut-out and the cladding.

If the niche cladding is made from a non-combustible material (e.g. metal, natural stone, ceramic tiles) the minimum safety distance ⑤ between the worktop cut-out and the cladding will be 50 mm less the thickness of the cladding.

Example: 15 mm niche cladding

50 mm - 15 mm = minimum safety distance of 35 mm

Flush-fit installation

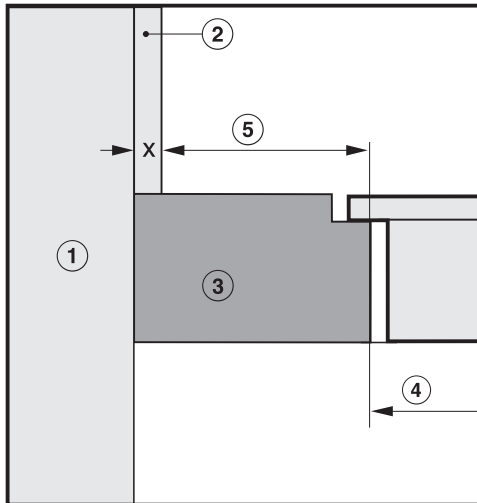

Onset installation

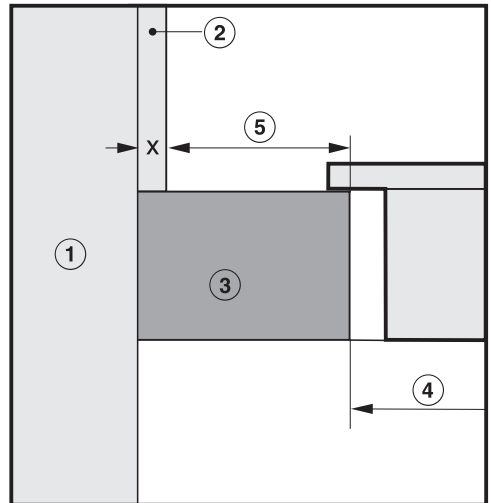

- ① Masonry
- ② Niche cladding dimension x = thickness of the niche cladding material
- ③ Worktop
- ④ Worktop cut-out
- ⑤ Minimum distance to
combustible materials 50 mm
non-combustible materials 50 mm - dimension x

Installation notes – surface-mounted

Sealing between the SmartLine Element and the worktop

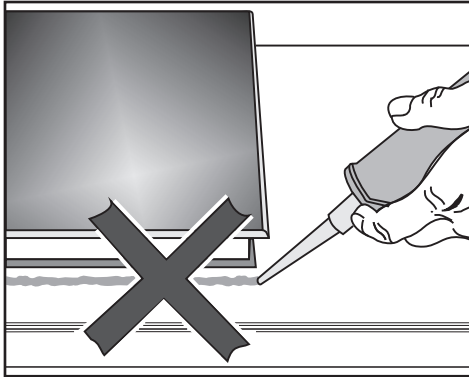

The SmartLine element and worktop may be damaged if the element needs to be removed after it has been sealed with a sealant.

Do not use any sealant between the SmartLine element and the worktop. The seal under the edge of the top part of the appliance provides a sufficient seal for the worktop.

Tiled worktop

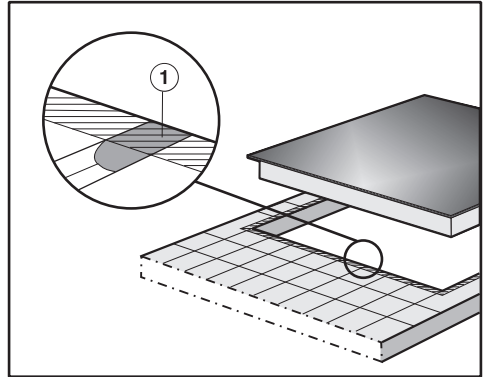

Grout lines ① and the hatched area underneath the SmartLine element frame must be smooth and even. If they are not, the SmartLine element will not sit flush with the worktop and the sealing strip underneath the top part of the appliance will not provide a good seal between the appliance and the worktop.

Sealing strip

Dismantling the SmartLine element for service purposes may damage the sealing strip underneath the edge of the SmartLine element.

Always replace the sealing strip before reinstalling the SmartLine element.

Installation

Installing several SmartLine elements

The gaps between the individual SmartLine elements are sealed with a silicone sealant that is heat-resistant to at least 160 °C. With flush-fit installation, the gap between the SmartLine element(s) and the worktop must also be sealed with a silicone sealant that is heat-resistant to at least 160 °C.

After installation, the SmartLine elements must be easily accessible from below, so that the bottom half of the casing can be removed for maintenance. If the SmartLine elements are not accessible from below, the sealant must be removed so that they can be removed.

Combination with a downdraft extractor

If the SmartLine element is installed in combination with a downdraft extractor, the latter must be installed first.

Induction wok next to the downdraft extractor





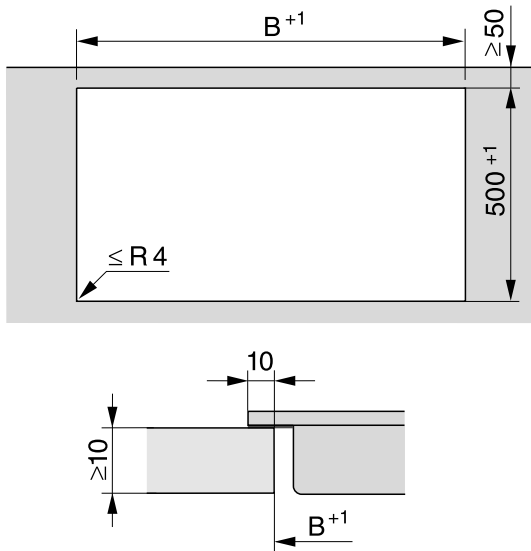

The induction wok can only be fitted on the side of the downdraft extractor opposite the connector.

Worktop cutout – surface-mounted











Installation

Installation with a countertop extractor

Combination examples	Number x width [mm]		Dimension B [mm]
	Cooking elements	Countertop extractor	
	1 x 378	1 x 120	481
	2 x 378	1 x 120	862
	1 x 378 1 x 620	2 x 120	1226
	3 x 378	2 x 120	1365
	2 x 378 1 x 620	2 x 120	1607
	4 x 378	2 x 120	1746
	1 x 620	2 x 120	845

Installation without a countertop extractor

Combination examples	Number x width [mm] Cooking elements	Dimension B [mm]
	1 x 378	359
	2 x 378	740
	1 x 378 1 x 620	982
	3 x 378	1121
	2 x 378 1 x 620	1363
	4 x 378	1502
	2 x 378 1 x 800	1554
	2 x 378 1 x 936	1680

Installation

Spacer bars – surface-mounted

If you are installing several appliances, you must fit spacer bars between them.

The clips supplied with the spacer bars are only required for installing a CSDA 700x FL.

Installing 3 elements and 2 spacer bars

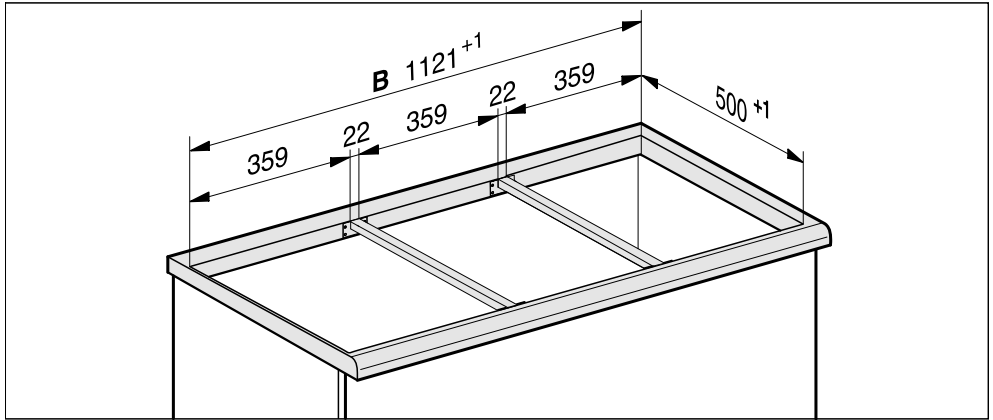

Installation dimensions – Surface-mounted

All dimensions are given in mm.

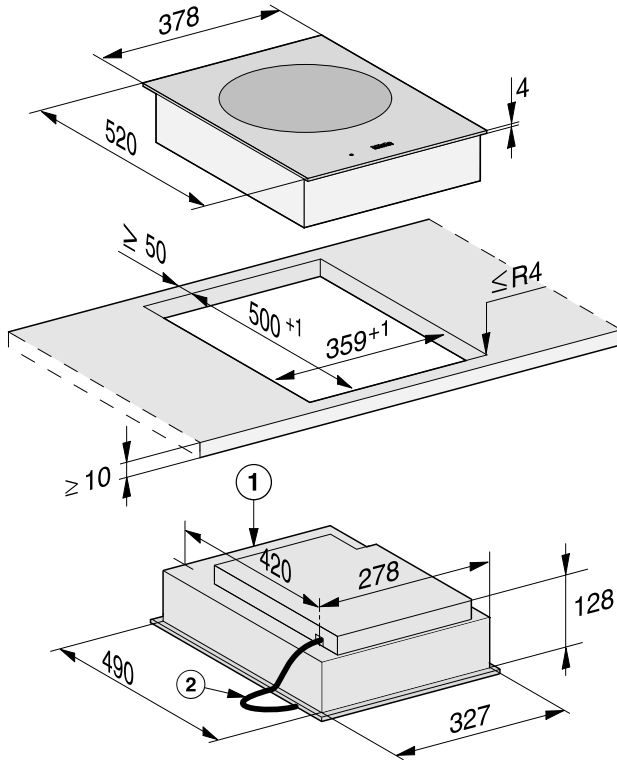

① Front

② Mains connection cable, L = 2000 mm

Installation

Installation – surface-mounted

Preparing the worktop

- Create the worktop cutout. Remember to maintain the minimum safety distances (see “Installation – Safety distances”).
- Seal any cut surfaces on **wooden worktops** with a special varnish, silicone sealant or resin to prevent the wood from swelling as a result of moisture ingress. The sealant must be heat-resistant.

Make sure that the sealant does not come into contact with the top of the worktop.

Fitting the spacer bars

Use the middle screw holes if one of the following SmartLine elements is installed to the right or left of the spacer bar: CS 7611, CS 7641, CS 7101(-1), CS 7102(-1)

Wooden worktops

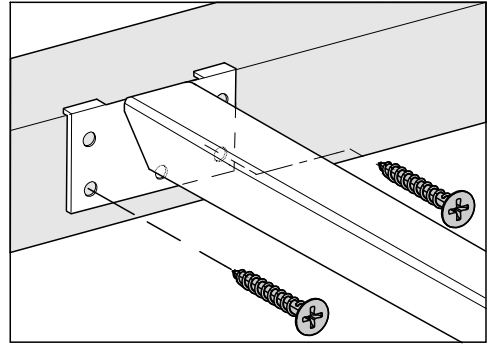

- Position the spacer bars flush onto the upper edge of the cutout.
- Secure the spacer bars with the 3.5 x 25 mm wood screws supplied.

Natural stone worktops

You will need heavy-duty double-sided tape (not supplied) to secure the spacer bars.

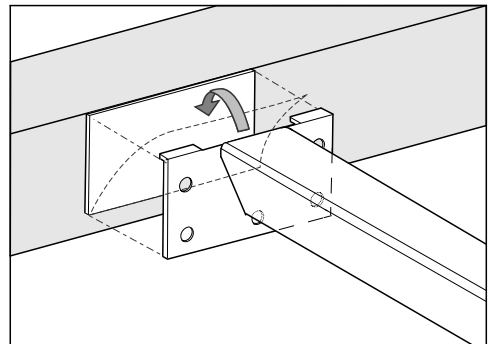

- Stick the tape along the top edge of the worktop cutout.
- Position the spacer bars flush onto the upper edge of the cutout.
- Press the spacer bars firmly into place.

Installing the SmartLine element

- Stick the supplied sealing strip under the edge of the SmartLine element. Do not apply the sealing strip under tension.
- Feed the mains connection cable down through the worktop cutout.
- Position the SmartLine element in the worktop cutout. Ensure that:
 - The seal of the appliance sits flush with the worktop on all sides to ensure an effective seal all round.
 - All gap widths are uniform.
- If the seal does not meet the worktop correctly on the corners, carefully scribe the corner radii ($\leq R4$) with a jigsaw.

Do not use any additional sealant (e.g. silicone) on the SmartLine element.

- Connect the SmartLine element to the mains electricity supply.
- If required, connect the SmartLine element to the gas supply (see “Installation – Gas connection”).
- Check that the SmartLine element works.
- Seal the gaps between the individual elements with a silicone sealant that is heat-resistant to at least 160 °C.

Unsuitable sealant can damage natural stone.

For natural stone worktops and natural stone tiles, only use silicone sealant that is specially formulated for natural stone. Follow the manufacturer's instructions.

Installation

Installation notes – flush-fit

Flush-fit installation is only possible in natural stone (granite, marble), solid wood and tiled worktops. For installation in worktops made of other materials, please consult the relevant manufacturer as to whether their worktops are suitable for flush-fit installation.

The internal width of the base unit underneath the appliance must be at least as wide as the inner worktop cutout (see “Installation – Building-in dimensions – flush-fit”), so that the SmartLine element is easily accessible from underneath after installation and the bottom half of the casing can be removed for maintenance. If the element is not freely accessible from below after installation, the sealant must be removed so that the element can be removed.

Natural stone worktops

The SmartLine element is set directly in the cutout.

Solid wood worktops, tiled worktops, glass worktops

The SmartLine element is set on a wooden frame inside the cutout. The frame must be provided on site, and is not supplied with the appliance.

Sealing strip

Dismantling the SmartLine element for service purposes may damage the sealing strip underneath the edge of the SmartLine element.

Always replace the sealing strip before reinstalling the SmartLine element.

Installing several SmartLine elements

The gaps between the individual SmartLine elements are sealed with a silicone sealant that is heat-resistant to at least 160 °C. With flush-fit installation, the gap between the SmartLine element(s) and the worktop must also be sealed with a silicone sealant that is heat-resistant to at least 160 °C.

After installation, the SmartLine elements must be easily accessible from below, so that the bottom half of the casing can be removed for maintenance. If the SmartLine elements are not accessible from below, the sealant must be removed so that they can be removed.

Combination with a downdraft extractor

If the SmartLine element is installed in combination with a downdraft extractor, the latter must be installed first.

Induction wok next to the downdraft extractor

The induction wok can only be fitted on the side of the downdraft extractor opposite the connector.

Installation

Worktop cutout – flush-fit

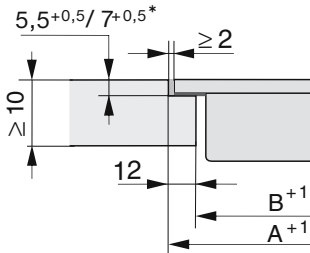
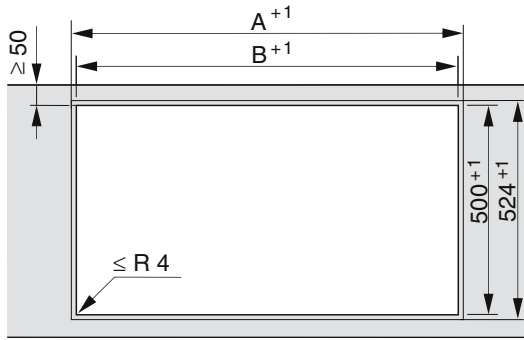



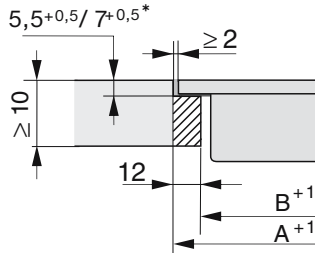



Natural stone worktop



Wooden worktop









* $7^{+0,5}$ mm with CS 7611 FL

Installation with a countertop extractor

Combination examples	Number x width [mm]		Dimension A [mm]	Dimension B [mm]
	Cooking elements	Countertop extractor		
	1 x 378	1 x 120	505	481
	2 x 378	1 x 120	886	862
	1 x 378 1 x 620	2 x 120	1250	1226
	3 x 378	2 x 120	1389	1365
	2 x 378 1 x 620	2 x 120	1631	1607
	4 x 378	2 x 120	1770	1746
	1 x 620	2 x 120	869	845

Installation

Installation without a countertop extractor

Combination ex- amples	Number x width [mm] Cooking elements	Dimension A [mm]	Dimension B [mm]
	1 x 378	383	359
	2 x 378	764	740
	1 x 378 1 x 620	1006	982
	3 x 378	1145	1121
	2 x 378 1 x 620	1387	1363
	4 x 378	1526	1502
	2 x 378 1 x 800	1567	1543
	2 x 378 1 x 936	1703	1679

Spacer bars – flush-fit

If you are installing several appliances, you must fit spacer bars between them.

The clips supplied with the spacer bars are only required for installing a CSDA 700x FL.

Installing 3 elements and 2 spacer bars

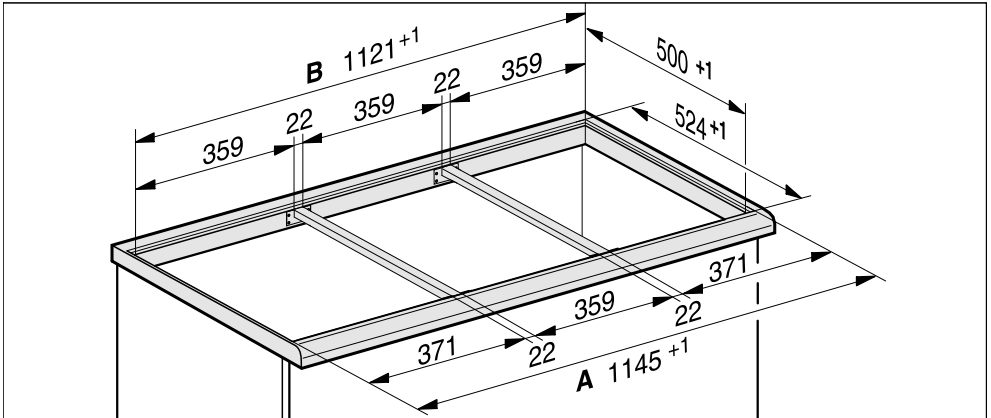

Installation

Installation dimensions – Flush-fit

All dimensions are given in mm.

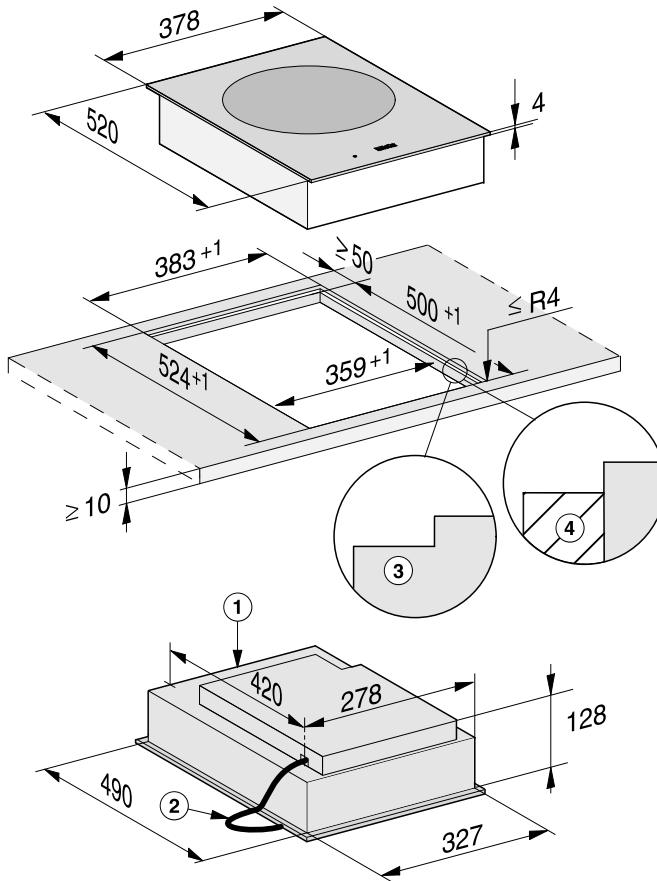

- ① Front
- ② Mains connection cable, L = 2000 mm
- ③ Stepped cutout (for detailed illustrations, see “Installation – Worktop cutout – flush-fit”)
- ④ 12 mm wooden frame (not supplied, for detailed illustrations, see “Installation – Worktop cutout – flush-fit”)

Installation – flush-fit

Preparing the worktop

- Create the worktop cutout. Remember to maintain the minimum safety distances (see “Installation – Safety distances”).
- Seal any cut surfaces on **wooden worktops** with a special varnish, silicone sealant or resin to prevent the wood from swelling as a result of moisture ingress. The sealant must be heat-resistant.

Make sure that the sealant does not come into contact with the top of the worktop.

- For wooden worktops, secure the wooden frame 5.5 mm below the upper edge of the worktop. For CS 7611 FL, the wooden frame must be secured 7 mm under the upper edge of the worktop.

Fitting the spacer bars

Use the middle screw holes if one of the following SmartLine elements is installed to the right or left of the spacer bar: CS 7611, CS 7641, CS 7101(-1), CS 7102(-1)

Wooden worktops

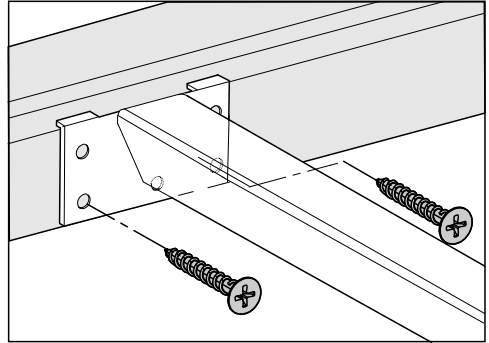

- Position the spacer bars flush onto the lower step of the stepped cutout.
- Secure the spacer bars with the 3.5 x 25 mm wood screws supplied.

Natural stone worktops

You will need heavy-duty double-sided tape (not supplied) to secure the spacer bars.

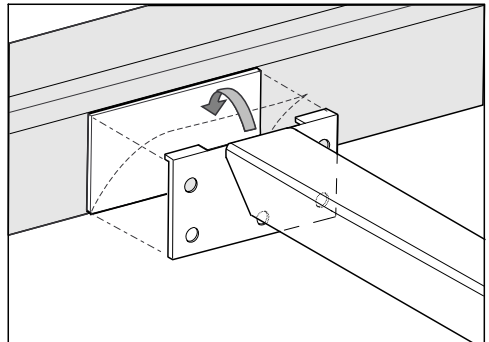

- Stick the tape onto the lower step of the stepped cutout.
- Position the spacer bars flush onto the lower step of the stepped cutout.
- Press the spacer bars firmly into place.

Installation

Installing the SmartLine element

- Stick the supplied sealing strip under the edge of the SmartLine element. Do not apply the sealing strip under tension.
- Feed the mains connection cable down through the worktop cutout.
- Position the SmartLine element in the worktop cutout. Ensure that:
 - The seal of the appliance sits flush with the worktop on all sides to ensure an effective seal all round.
 - All gap widths are uniform.
- Connect the SmartLine element to the mains electricity supply.
- If required, connect the SmartLine element to the gas supply (see “Installation – Gas connection”).
- Check that the SmartLine element works.
- Seal the gaps between the individual elements and between the elements and the worktop with a silicone sealant that is heat-resistant to at least 160 °C.

Unsuitable sealant can damage natural stone.

For natural stone worktops and natural stone tiles, only use silicone sealant that is specially formulated for natural stone. Follow the manufacturer’s instructions.

Electrical connection

 Risk of damage from incorrect connection.

Unauthorised installation, maintenance and repairs can cause considerable danger for the user.

Miele cannot be held liable for damage or injury caused by unauthorised installation, maintenance or repair work, or by an inadequate or faulty on-site earthing system (e.g. electric shock).

This SmartLine element must be connected to the electrical supply by a qualified electrician.

The electrician must be familiar with and comply with the national regulations and any additional regulations of the local electricity provider (e.g. BS 7671 in the UK).

After installation, ensure that all electrical components are shielded and cannot be accessed by users.

Total power rating

See data plate

Connection data

The connection data is quoted on the data plate. Please ensure these match the household mains supply.

Residual current device

For extra safety, it is advisable to protect the SmartLine element with a suitable residual current device (RCD) with a trip range of 30 mA.

Disconnecting devices

It must be possible to disconnect the SmartLine element from the mains at all poles using disconnecting devices! A contact distance of at least 3 mm must be observed in the switched-off state! The disconnecting devices are overcurrent protection devices and residual current protection devices.

Installation

Disconnecting from the mains



Risk of electric shock.

There is a risk of electric shock if the appliance is connected to the mains supply during repair or service work. After disconnection, ensure the appliance cannot be switched back on by mistake.

To disconnect the appliance from the mains power supply, do one of the following depending on installation:

Safety fuses

- Completely remove fuses.

Automatic circuit breakers

- Press the (red) test button until the middle (black) button springs out.

Built-in circuit breakers

- Circuit breakers at least type B or C:
Switch the lever from 1 (on) to 0 (off).

Residual current device (RCD)

- Switch the main switch from 1 (on) to 0 (off) or press the test button.

Replacing the mains connection cable



Risk of electric shock.

Incorrect connection to the power supply may result in an electric shock.

The mains cable must only be replaced by a qualified electrician.

When replacing the mains cable only use cable type H 05 VV-F with a suitable cross section. A suitable connection cable is available to order from Miele.

United Kingdom

Miele Co. Ltd., Fairacres, Marcham Road, Abingdon, Oxon, OX14 1TW
Tel: 0330 160 6600, Internet: www.miele.co.uk/service, E-mail: info@miele.co.uk

Australia

Miele Australia Pty. Ltd.
ACN 005 635 398
ABN 96 005 635 398
1 Gilbert Park Drive
Knoxfield, VIC 3180
Tel: 1300 464 353
Internet: www.miele.com.au

China Mainland

Miele Electrical Appliances Co., Ltd.
1-3 Floor, No. 82 Shi Men Yi Road
Jing' an District
200040 Shanghai, PRC
Tel: +86 21 6157 3500
Fax: +86 21 6157 3511
E-mail: info@miele.cn
Internet: www.miele.cn

Hong Kong, China

Miele (Hong Kong) Ltd.
41/F - 4101, Manhattan Place
23 Wang Tai Road
Kowloon Bay, Hong Kong
Tel: (852) 2610 1025
Fax: (852) 3579 1404
Email:
customerservices@miele.com.hk
Website: www.miele.hk

India

Miele India Pvt. Ltd.
1st Floor, Copia Corporate Suites,
Commercial Plot 9,
Mathura Road, Jasola,
New Delhi - 110025
E-mail: customercare@miele.in
Website: www.miele.in

Ireland

Miele Ireland Ltd.
2024 Bianconi Avenue
Citywest Business Campus
Dublin 24
Tel: (01) 461 07 10
Fax: (01) 461 07 97
E-Mail: info@miele.ie
Internet: www.miele.ie

Malaysia

Miele Sdn Bhd
Suite 12-2, Level 12
Menara Sapura Kencana
Petroleum
Solaris Dutamas No. 1
Jalan Dutamas 1
50480 Kuala Lumpur, Malaysia
Phone: +603-6209-0288
Fax: +603-6205-3768

New Zealand

Miele New Zealand Limited
IRD 98 463 631
8 College Hill
Freemans Bay, Auckland 1011
New Zealand
Tel: 0800 464 353
Internet: www.miele.co.nz

Singapore

Miele Pte. Ltd.
29 Media Circle
#11-04 ALICE@Mediapolis
Singapore 138565
sTel: +65 6735 1191
Fax: +65 6735 1161
E-Mail: info@miele.com.sg
Internet: www.miele.sg

South Africa

Miele (Pty) Ltd.
63 Peter Place
Bryanston 2194
P.O. Box 69434
Bryanston 2021
Tel: (011) 875 9000
Fax: (011) 875 9035
E-mail: info@miele.co.za
Internet: www.miele.co.za

Thailand

Miele Appliances Ltd.
BHIRAJ TOWER at EmQuartier
43rd Floor Unit 4301-4303
689 Sukhumvit Road
North Klongton Sub-District
Vadhana District
Bangkok 10110, Thailand

United Arab Emirates

Miele Appliances Ltd.
Showroom 1
Eiffel 1 Building
Sheikh Zayed Road, Umm Al Sheif
P.O. Box 114782 - Dubai
Tel. +971 4 3044 999
Fax. +971 4 3418 852
800-MIELE (64353)
E-Mail: info@miele.ae
Website: www.miele.ae

Manufacturer: Miele & Cie. KG, Carl-Miele-Straße 29, 33332 Gütersloh, Germany

CS 7641

en-GB

M.-Nr. 11 419 780 / 02