



*The Signature of Quality®*

**IMSS60, IMSS84, IMSS120, EIMSS60 & EIMSS84 MODELS  
INSTALLATION & OPERATIONS MANUAL**



**KEEP THIS MANUAL FOR FUTURE REFERENCE**

Engineering and technical data are subject to change without notice.

FEDERAL INDUSTRIES  
Toll Free 1(800) 356-4206

215 Federal Ave.  
WI Phone (608) 424-3331

Belleville, WI 53508  
Fax: (608) 424-3234

# CONTENTS

<b>INTRODUCTION.....</b>	<b>3</b>
<b>WARNING LABELS &amp; SAFETY INSTRUCTIONS .....</b>	<b>4</b>
<b>REFRIGERATION WARNING (INSTALL-REPAIR-DECOMMISSIONING) .....</b>	<b>5-10</b>
<b>PRE-INSTALLATION PROCEDURES .....</b>	<b>11</b>
INSPECTION FOR SHIPPING DAMAGE .....	11
<b>INSTALLATION INSTRUCTIONS.....</b>	<b>11-22</b>
LOCATING THE DISPLAY CASE .....	11
ELECTRICAL CONNECTION .....	12
PERMANENT CONNECTED.....	12
STANDARD BASE ELECTRICAL CONNECTION .....	12
TOP ELECTRICAL CONNECTION.....	12
CORD CONNECTED .....	13
REMOVING CASE FROM SHIPPING SKID .....	13
REMOVING PACKAGING MATERIAL .....	14
LEVELING THE CASE.....	14
SEALING THE UNIT TO THE FLOOR .....	14
BASE PANELS REMOVAL IMSS60 & IMSS84.....	15
BASE PANELS REMOVAL IMSS120 .....	16
BASE COMPONENT LAYOUT .....	17-18
CONDENSATE EVAPORATOR .....	19
CONDENSATE PAN SHIPPED LOOSE.....	19
CONDENSATE PUMP .....	20
SHELVES .....	21-22
<b>OPERATING INSTRUCTIONS.....</b>	<b>23-26</b>
USER CONTROLS .....	23-25
INITIAL START UP .....	26
PLACING PRODUCT IN CASE .....	26
<b>CLEANING INSTRUCTIONS.....</b>	<b>26-29</b>
ACRYLIC AIR DEFLECTOR .....	26
DAILY CLEANING.....	27
WEEKLY CLEANING .....	27-28
<b>MAINTENANCE .....</b>	<b>29</b>
CLEANING CONDENSER COIL .....	29
<b>SERVICE INFORMATION .....</b>	<b>30-32</b>
PRE-SERVICE CHECKLIST .....	31
SPECIAL SERVICE SITUATIONS .....	32
<b>SALE &amp; DECOMMISSIONING .....</b>	<b>33</b>
<b>ELECTRICAL DATA.....</b>	<b>34</b>
<b>CONTROL OPERATION .....</b>	<b>35-38</b>
ELECTRONIC CONTROL .....	35
OPERATION.....	35
DEFROST CYCLE.....	35
CONTROL PARAMETERS .....	36-38
<b>REFRIGERATION OPERATION .....</b>	<b>39-41</b>
SELF CONTAINED OPERATION .....	39
REMOTE OPERATION.....	39-40
ELECTRONIC EXPANSION VALVE (EEV).....	41
<b>REPLACEMENT PARTS - .....</b>	<b>42</b>
<b>WIRING DRAWING .....</b>	<b>43-48</b>

# INTRODUCTION

---

Thank you for purchasing a Federal Industries Merchandiser. This manual contains important instructions for installing and servicing the RSSM, Refrigerated Self-Service Merchandisers. A repair parts list is also included in the manual. Read all of these documents carefully before installing or servicing your case.



### NOTICE

**Read this manual before installing your case. Keep this manual and refer to it before doing any service on the equipment. Failure to do so could result in personal injury or damage to the case.**



### NOTICE

**Installation and service of the electrical components in the case must be performed by a licensed electrician.**

The portions of this manual covering components contain technical instructions intended only for persons qualified to perform electrical work.



### DANGER

**Improper or faulty hookup of electrical components in the case can result in severe injury or death.**

**All electrical wiring hookups must be done in accordance with all applicable local, regional, or national standards.**

**NOTE: UNIT MUST BE GROUNDED**

## REGISTRATION & SERIAL NUMBER

It's important to keep a record of the model and serial number of your merchandiser for warranty and part identification. Please write them here for your quick reference.

**Register your product online!** Visit our website at [www.federalindustries.com](http://www.federalindustries.com) and register your product today.

Case Model \_\_\_\_\_ Serial  
Number \_\_\_\_\_

We're here to provide you with the best possible experience with your new product, however, we cannot cover everything about your merchandiser in this manual, so if you have any additional questions or issues, please see the SERVICE INFORMATION PAGE to find who you should contact.



---

# WARNING LABELS & SAFETY INSTRUCTIONS

---



This is the safety-alert symbol. When you see this symbol on your case or in the manual, be alert to the potential for personal injury or damage to your equipment.

Be sure you understand all safety messages and always follow recommended precautions and safe operating procedures.



## NOTICE TO EMPLOYERS

You must make sure that everyone who installs, uses, or services your case is thoroughly familiar with all safety information and procedures.

Important safety information is presented in this section and throughout the manual. The following signal words are used in the warning and safety messages:

- DANGER:** Severe injury or death **will** occur if you ignore the message.
- WARNING:** Severe injury or death **can** occur if you ignore the message.
- CAUTION:** Minor injury or damage to your case **can** occur if you ignore the message.
- NOTICE:** This is important installation, operation, or service information. If you ignore the message, you may damage your case.

---

The warning and safety labels shown throughout this manual are placed on your Federal Industries case at the factory. Follow all warning label instructions. If any warning or safety labels become lost or damaged, call our customer service department at 1(800) 356-4206 for replacements.

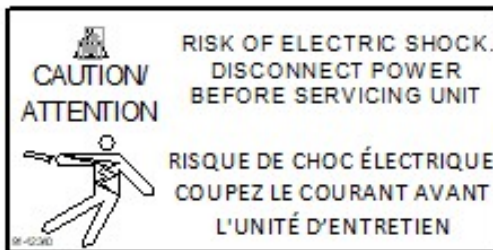

*This label is located behind the removable base panels display and under deck pans.*



*This label is located under display deck*

DANGER – Risk of fire or explosion. Flammable refrigerant used. Consult repair manual/owner's guide before attempting to service this product. all safety precautions must be followed

91-2181-4

DANGER — Risque d'incendie ou d'explosion. Fluide frigorigène utilisé. Consulter le guide propriétaire ou le manuel de réparations avant de l'essayer d'installer ou de réparer ce produit. Toutes les précautions de sécurité doivent être suivies.

91-2181-4

*This label is located by condensing unit*

---

# REFRIGERATION WARNING

## INSTALLATION-REPAIR-DECOMMISSIONING

---



This is the Danger-Flammable symbol. When you see this symbol on your case or in the manual, be alert to the potential for risk of fire or explosion.

Be sure you understand all safety messages and always follow recommended precautions and safe operating procedures.

### **DANGER**



**Risk of fire or explosion. Flammable refrigerant used. To be repaired only by trained service personnel. Do not puncture refrigerant tubing. Dispose of properly in accordance with federal or local regulations**

**Consult repair manual/owner's guide before attempting to service this product. All safety precautions must be followed.**

**Follow handling instructions carefully in compliance with national regulations.**

**Auxiliary devices which may be ignition sources shall not be installed in the ductwork, other than auxiliary devices listed for use with the specific appliance.**

**Do not store explosive substances (such as aerosol cans with a flammable propellant) in this case.**

**Do not use an electrical appliance INSIDE the food storage compartments unless its type is recommended by manufacturer.**

**Flammable refrigerant type specified on case nameplate is on the serial label.**

**APPLIES TO R290 REFRIGERANT MODELS ONLY! Contains a charge of R290 refrigerant with a lower flammability limit (LFL) of .038kg/m<sup>3</sup>. See table for amount of charge.**

## WARNING

- Do not use means to accelerate the defrosting process or to clean, other than those recommended by the manufacturer.
- The appliance shall be stored in a room without continuously operating ignition sources  
For example: open flames, an operating gas appliance or an operating electric heater.
- Do not pierce or burn.
- Be aware that refrigerants may not contain an odor.

## MISE EN GARDE

- Ne pas utiliser de moyens autres que ceux recommandés par le fabricant pour accélérer le processus de dégivrage ou pour nettoyer l'appareil.
- L'appareil doit être entreposé dans un local ne contenant pas de sources d'inflammation permanentes (flammes nues, appareil à gaz ou dispositif de chauffage électrique en fonctionnement, par exemple).
- Ne pas percer ou brûler.
- Attention, les fluides frigorigènes peuvent ne pas dégager d'odeur.

**3. Qualification:** All refrigeration and electrical maintenance, service, and repair must be performed by a Certified Technician that is trained in the required flammable refrigerants safety procedures. Technicians must read the entire section "REFRIGERATION WARNINGS SECTION" of this manual.

Including but not limited to the following:

- a) breaking into the refrigerating circuit.
- b) opening of sealed components.
- c) opening of ventilated enclosures.

**4. Checks to Area:** Prior to beginning work on systems containing FLAMMABLE REFRIGERANTS, safety checks are necessary to ensure that the risk of ignition is minimized prior to conducting work on the system.

- Capacitors are discharged: this shall be done in a safe manner to avoid possibility of sparking.
- No live electrical components and wiring are exposed while charging, recovering or purging the system.
- Continuity of earth bonding.

- Work shall be undertaken under a controlled procedure to minimize the risk of a flammable gas or vapor being present while the work is being performed.
- All maintenance staff and others working in the local area shall be instructed on the nature of the work being carried out. Work in confined spaces shall be avoided.
- The area shall be checked with an appropriate refrigerant detector prior to and during work, to ensure the technician is aware of potentially toxic or flammable atmospheres. Ensure that the leak detection equipment being used is suitable for use with all applicable refrigerants, i.e., non-sparking, adequately sealed, or intrinsically safe.
  
- If any hot work is to be conducted on the refrigerating equipment or any associated parts, appropriate fire extinguishing equipment shall be available on hand. A dry chemical or CO2 fire extinguisher should be adjacent to the charging area.
  
- No person carrying out work in relation to a REFRIGERATING SYSTEM which involves exposing any pipe work shall use any sources of ignition in such a manner that it may lead to the risk of fire or explosion. All possible ignition sources, including cigarette smoking, should be kept sufficiently far away from the site of installation, repairing, removing and disposal, during which refrigerant can possibly be released to the surrounding space. Prior to work taking place, the area around the equipment shall be surveyed to make sure that there are no flammable hazards or ignition risks. "No Smoking" signs shall be displayed.
  
- Ensure that the area is in the open or that it is adequately ventilated before breaking into the system or conducting any hot work. A degree of ventilation shall continue during the period that the work is carried out. The ventilation should safely disperse any released refrigerant and preferably expel it externally into the atmosphere.
  
- Where electrical components are being changed, they shall be fit for the purpose and to the correct specification so as to minimize the risk of possible ignition due to incorrect parts. At all times, the manufacturer's maintenance and service guidelines shall be followed. If in doubt, consult the manufacturer's technical department for assistance. The following checks shall be applied to installations using flammable refrigerants:
  - a) the actual REFRIGERANT CHARGE is in accordance with the room size within which the refrigerant containing parts are installed.
  - b) The ventilation machinery and outlets are operating adequately and are not obstructed.
  - c) Markings of the equipment continue to be visible and legible. Markings and signs that are illegible shall be corrected.
  - d) Refrigerating pipe or components are installed in a position where they are unlikely to be exposed to any substance which may corrode refrigerant containing
  
- Repair and maintenance to electrical components shall include initial safety checks and component inspection procedures. If a fault exists that could compromise safety, then no electrical supply shall be connected to the circuit until it is satisfactorily dealt with. If the fault cannot be corrected immediately but it is necessary to continue operation, an adequate temporary solution shall be used. This shall be reported to the owner of the Initial safety checks shall include:

## **5. Repairs to sealed components**

-During repairs to sealed components, all electrical supplies shall be disconnected from the equipment being worked upon prior to any removal of sealed covers, etc. If it is necessary to have an electrical supply to equipment during servicing, then a permanently operating form of leak detection shall be located at the most critical point to warn of a potentially hazardous situation.

-Particular attention shall be paid to the following to ensure that by working on electrical components, the casing is not altered in such a way that the level of protection is affected. This shall include damage to cables, excessive number of connections, terminals not made to original specification, damage to seals, incorrect fitting of glands, etc. Ensure that the apparatus is mounted securely.

Ensure that seals or sealing materials have not degraded to the point that they no longer serve the purpose of preventing the ingress of flammable atmospheres. Replacement parts shall be in accordance with the manufacturer's specifications.

-Do not apply any permanent inductive or capacitance loads to the circuit without ensuring that this will not exceed the permissible voltage and current permitted for the equipment in use.

NOTE The use of silicon sealant can inhibit the effectiveness of some types of leak detection equipment. Intrinsically safe components do not have to be isolated prior to working on them.

**8. Detection of flammable refrigerants:** Under no circumstances shall potential ignition sources be used in the searching for or detection of refrigerant leaks. A halide torch (or any other detector using a naked flame) shall not be used.

**The following leak detection methods are deemed acceptable for all refrigerant systems:**

-Electronic leak detectors may be used to detect refrigerant leaks but, in the case of FLAMMABLE REFRIGERANTS, the sensitivity might not be adequate or might need recalibration. (Detection equipment shall be calibrated in a refrigerant-free area.) Ensure that the detector is not a potential source of ignition and is suitable for the refrigerant used. Leak detection equipment shall be set at a percentage of the LFL of the refrigerant and shall be calibrated to the refrigerant employed, and the appropriate percentage of gas (25 % maximum) is confirmed.

-Leak detection fluids are also suitable for use with most refrigerants but the use of detergents containing chlorine shall be avoided as the chlorine can react with the refrigerant and corrode the copper pipework.

NOTE Examples of leak detection fluids are

- bubble method,
- fluorescent method agents.

If a leak is suspected, all naked flames shall be removed/extinguished.

If a leakage of refrigerant is found which requires brazing, all the refrigerants shall be recovered from the system, or isolated (by means of shut off valves) in a part of the system

remote from the leak.

**9. Removal and Evacuation:** When breaking into the refrigerant circuit to make repairs-or for any other purpose-conventional procedures shall be used. However, for flammable refrigerants it is important that the best practice be followed, since flammability is a consideration. The following procedure shall be adhered to:

- a. Safely remove refrigerant following local and national regulations.
- b. Purge the circuit with inert gas.
- c. Evacuate (optional for A2L).
- d. Purge with inert gas (optional for A2L).
- e. Open the circuit by cutting or brazing.

The refrigerant change shall be recovered into the correct recovery cylinders if venting is not allowed by local and national codes. For appliances containing flammable refrigerants, the system shall be purged with oxygen-free nitrogen to render the appliance safe for flammable refrigerants. This process might need to be repeated several times. Compressed air or oxygen shall not be used for purging refrigerant systems. For appliances containing flammable refrigerants, refrigerant purging shall be achieved by breaking the vacuum in the system with oxygen-free nitrogen and continuing to fill until the working pressure is achieved, then venting to atmosphere, and finally pulling down to a vacuum (optional for A2L). This process shall be repeated until no refrigerant is within the system (optional for A2L). When the final oxygen-free nitrogen change is used, the system shall be vented down to atmospheric pressure to enable work to take place. Ensure that the outlet for the vacuum pump is not close to any potential ignition sources and that ventilation is available.

**10. Charging procedures:** In addition to conventional charging procedures, the following requirements shall be followed.

- a. Ensure that contamination of different refrigerants does not occur when using charging equipment. Hoses or lines shall be as short as possible to minimize the amount of refrigerant contained in them.
- b. Cylinders shall be kept in an appropriate position according to the instructions.
- c. Ensure that the REFRIGERATING SYSTEM is earthed prior to charging the system with refrigerant.
- d. Label the system when charging is complete (if not already).
- e. Extreme care shall be taken not to overfill the REFRIGERATING SYSTEM.

**11. Decommissioning:** Before carrying out this procedure, it is essential that the technician is completely familiar with the equipment and all its details. It is recommended good practice that all refrigerants are recovered safely. Prior to the task being carried out, an oil and refrigerant sample shall be taken in case analysis is required prior to re-use of recovered refrigerant. It is essential that electrical power is available before the task commences.

- a. Become familiar with the equipment and its operation.
- b. Isolate the system electrically.
- c. Before attempting the procedure, ensure that:
  - i. Mechanical handling equipment is available, if required, for handling refrigerant cylinders.
  - ii. All personal protective equipment is available and being used correctly.
  - iii. The recovery process is supervised at all times by a competent person.
  - iv. Recovery equipment and cylinders conform to the appropriate standards.
- d. Pump down refrigerant system, if possible.

- e. If a vacuum is not possible, make a manifold so that refrigerant can be removed from various parts of the system.
- f. Make sure that the cylinder is situated on the scales before recovery takes place.
- g. Start the recovery machine and operate in accordance with instructions.
- h. Do not overfill cylinders (no more than 80% volume liquid charge).
- i. Do not exceed the maximum working pressure of the cylinder, even temporarily.
- j. When the cylinders have been filled correctly and the process completed, make sure that the cylinders and the equipment are removed from the site properly and all isolation valves on the equipment are closed off.
- k. Recovered refrigerant shall not be charged into another refrigerating system unless it has been cleaned and checked.

**12. Labeling:** Equipment shall be labeled stating that it has been de-commissioned and emptied of refrigerant. The label shall be dated and signed. For appliances containing flammable refrigerants, ensure that there are labels on the equipment stating the equipment contains flammable refrigerant.

**13.Recovery:** When removing the refrigerant from a system, either for servicing or decommissioning, it is recommended good practice that all refrigerants are removed safely.

When transferring refrigerant into cylinders, ensure that only appropriate refrigerant recovery cylinders are employed. Ensure that the correct number of cylinders for holding the total system charge is available. All cylinders to be used are designated for the recovered refrigerant and labeled for that refrigerant (i.e., special cylinders for the recovery of refrigerant). Cylinders shall be complete with pressure-relief valve and associated shut-off valve in good working order. Empty recovery cylinders are evacuated and, if possible, cooled before recovery occurs.

The recovery equipment shall be in good working order with a set of instructions concerning the equipment that is at hand and shall be suitable for the recovery of all appropriate refrigerants including, when applicable, FLAMMABLE REFRIGERANTS. In addition, a set of calibrated weighing scales shall be available and in good working order. Hoses shall be complete with leak-free disconnect coupling and in good condition. Before using the recovery machine, check that it is in satisfactory working order, has been properly maintained and that any associated electrical components are sealed to prevent ignition in the event of refrigerant release. Consult manufacturer if in doubt.

The recovered refrigerant shall be returned to the refrigerant supplier in the correct recovery cylinder, and the relevant waste transfer note arranged. Do not mix refrigerants in recovery units and especially not in cylinders.

If compressors or compressor oils are to be removed, ensure that they have been evacuated to an acceptable level to make certain that FLAMMABLE REFRIGERANT does not remain within the lubricant. The evacuation process shall be carried out prior to returning the compressor to the suppliers. Only electric heating to the compressor body shall be employed to accelerate this process. When oil is drained from a system, it shall be carried out safely.

---

---

# PRE-INSTALLATION PROCEDURES

---

---

## Inspection For Shipping Damage

You are responsible for filing all freight claims with the delivery truck line. Inspect all cartons and crates for damage as soon as they arrive. If damage is noted to shipping crates, cartons, or if a shortage is found, note this on the bill of lading (all copies) prior to signing.

If damage is discovered when the case is uncrated, immediately call the delivery truck line and follow-up the call with a written report indicating concealed damage to your shipment. Ask for an immediate inspection of your concealed damaged item. Crating material must be retained to show the inspector from the truck line.

---

---

# INSTALLATION INSTRUCTIONS

---

---

**IMPORTANT:** Read this Section of this manual located on page 5.  
“REFRIGERATION WARNING & INSTALLATION-REPAIR-DECOMMISSIONING”  
All refrigeration and electrical work must be performed by certified technicians.

The installation of the appliance and the refrigerant must only be performed by Federals approved Service or suitably qualified person.

Appliance to be installed in accordance with safety standards ANSI/ASHREA 15.  
The appliance shall not be installed in public corridors or lobbies.

This case is designed for a class 2 environment.

<u>Test room climate class</u>	<u>Dry bulb temperature [°F]</u>	<u>Relative Humidity [%]</u>	<u>Dew point [°F]</u>	<u>Water vapour mass in dry air [lbm water/lbm air]</u>	<u>Required Test Lab Temperature [°F]</u>
2.0	71.6	65	59.36	0.0108	89.6

NSF TYPE 1 Temperature cannot exceed 75 deg F and 55% humidity.

## Locating The Display Case

The case should be located where it is not subjected to the direct rays of the sun, heating ducts, grills, radiator, or ceiling fans, nor should it be located near open doors or main door entrances. Also, avoid locations where there is excessive air movement or air disturbances and avoid high humidity locations such as near cases with water misting or fogging devices. Failure to locate this case as stated will reduce the performance of your Island display and will affect temperature of interior of case and product.

The case requires a minimum of 48” of clearance is needed on all sides of the unit. Keep clear of obstruction of all ventilation openings in appliance.

## Electrical Connection

**IMPORTANT:** Read this Section of this manual located on page 5.

“REFRIGERATION WARNING & INSTALLATION-REPAIR-DECOMMISSIONING”

All refrigeration and electrical work must be performed by certified technicians.



**DANGER:** Improper or faulty hookup of electrical components in the display case can result in severe injury or death.

### **Permanent Connected (Standard)**

- Only a licensed electrician must perform all case electrical connections.
- All electrical wiring hookups must be done in accordance with all applicable local, regional, or national electrical standards.
- A separate circuit for each display case is required to prevent other appliances on the same circuit from overloading the circuit and causing malfunction.
- The electrical service must be grounded upon installation.
- See the electrical data plate located on the base end, for proper circuit size and wire ampacity.

**(See condensate pan section for special condensate pan wiring)**

**Standard Base Electrical Connection:** There are (2) different styles of electrical box connections as shown in pictures below. The electrical connection box is in the base for floor electrical connection. The box is accessible by removing the base panel. See “Panel Removal Section” of this manual for panel removal instructions. Remove electrical box cover to access electrical connection.

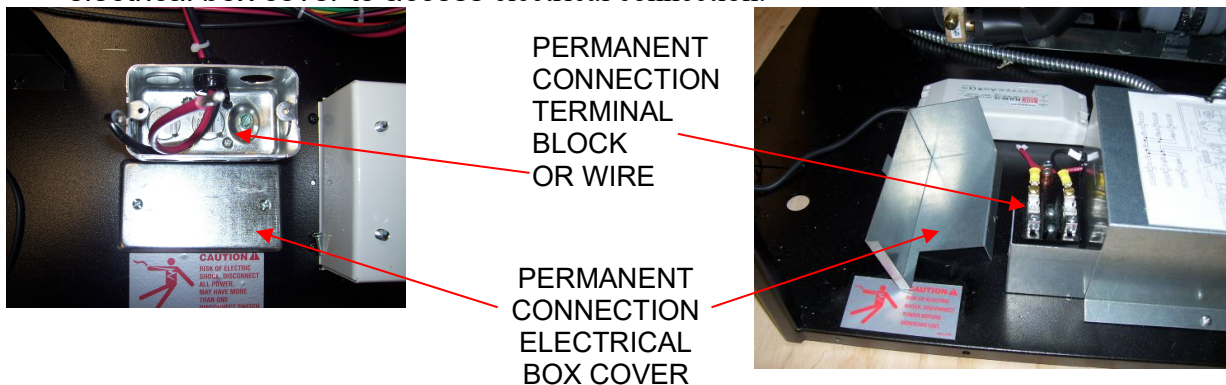

**Optional Top Electrical Connection:** The electrical connection box is accessible on the top of the case for ceiling drop electrical connection. Remove electrical box cover to access electrical connection.

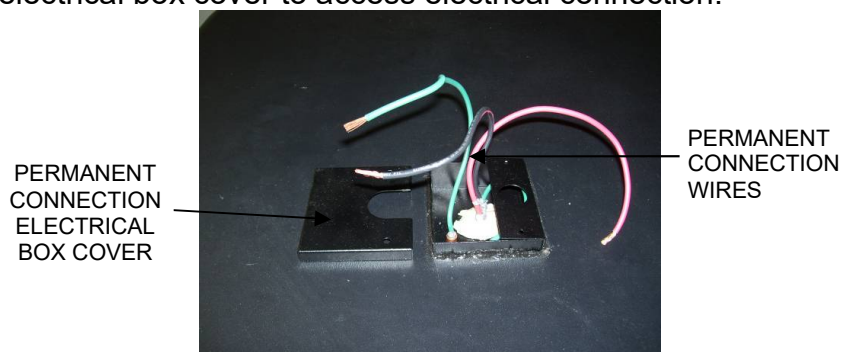

## **Cord Connected (OPTION)**

-A factory installed optional power cord is properly sized to the amperage requirements of the case. See the electrical data plate located on the rear exterior of the case for the proper circuit size for each case.

- The cord is factory installed protruding from the corner of the case.

-A separate circuit for each display case is required to prevent other appliances on the same circuit from overloading the circuit and causing malfunction.



**CAUTION** Risk of Electric Shock. If the cord or plug becomes damaged, replace only with a cord and plug of the same type".



## **Removing Case from Shipping Skid**

**CAUTION:** Do not push against the clear acrylic deflector around the sides and nose. Doing so can cause the acrylic to break.  
Do not lift or push on the top canopy located on top of the case. Doing so can permanently damage the tower frame.  
Care must be taken not to damage or tip the case when removing it from the skid or moving the case.

Remove the screws and brackets that secure the case to the skid. Remove the brackets from the case.

Note that the case may have optional wheels installed and once the brackets holding the case to the skid are removed the case will roll.



## **Removing Packaging Material**

Remove bubble wrap and packing material for all shelves and panel, brackets, etc. If it is necessary to remove tape residue from plastic materials, use cleaning compounds recommended in the cleaning section of this manual.

## **Leveling The Case**

The case must be level for proper drainage of defrost water to the condensate pump. A wrench is included to aid in adjusting leg levelers

Check the level of the case where the display overhangs the base.

Adjust the (4) outside leg levelers as needed to **level** the case in each direction.

The IMSS120 has (2) center leg levelers adjust these so that the center of base floor is flat.

**NOTE:** Use a wood or plastic shim under each leg leveler to avoid scratching the tile floor.

## **Sealing Unit To The Floor**

After the unit is positioned and the leg levelers are turned out, the unit needs to be sealed to the floor for NSF approved installation.

## **Base Panel Removal IMSS60 and IMSS84 Panels**



**DANGER: Electric shock hazard. Do not operate unit with panels removed.**

Panels must be in place when operating the case.

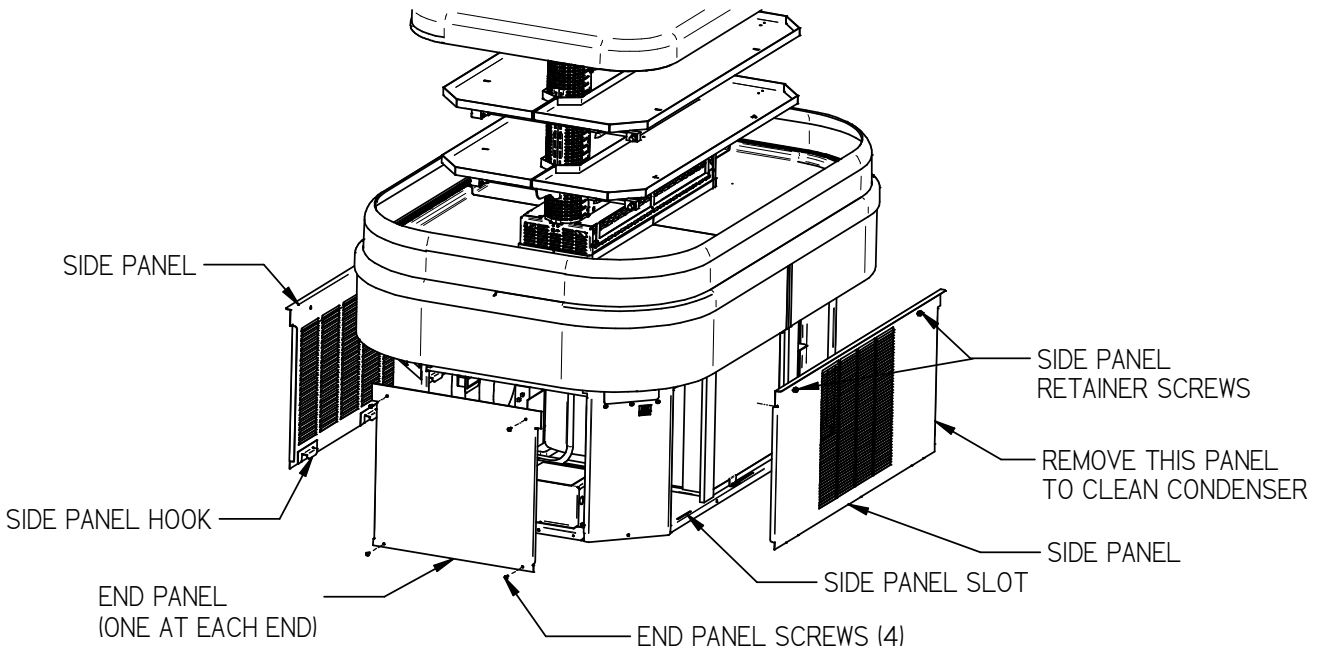

### **Side Panels**

1. Loosen the 2 retainer screws from top of panel.  
(The screws will stay on the panel even after they are detached from base)
2. Tilt the top of the panel away from the base and pull up on panel to allow the side panel tabs to pull out of the side panel slots.
3. Set the panel in a safe place to prevent damage.
4. Reinstall panels in the reverse order.

### **End Panels**

1. Remove the (4) retainer screws from all four corners of end panel.
2. Remove end panel from case and set it in safe place to prevent damage.
3. Reinstall panels in the reverse order.

## Base Panel Removal IMSS120 Panels



**DANGER: Electric shock hazard. Do not operate unit with panels removed.**

Panels must be in place when operating the case.

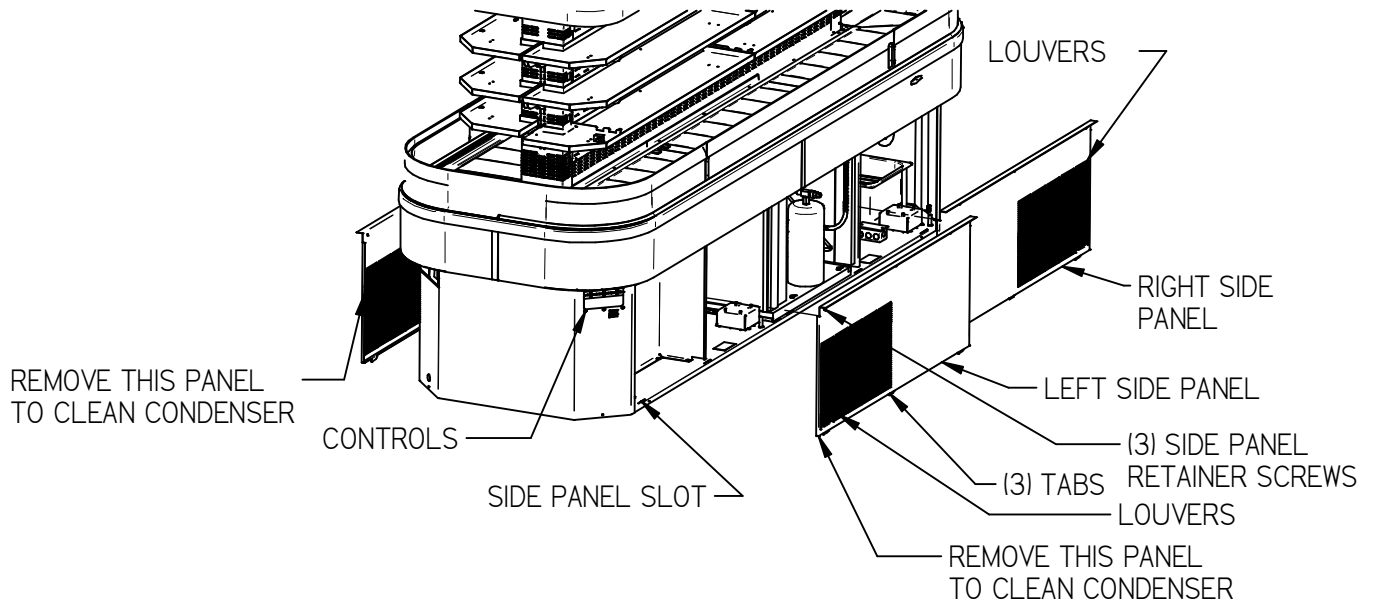

### Side Panels

1. Loosen the 3 retainer screws from top of each side panel.  
(The screws will stay on the panel even after they are detached from base)
2. Tilt the top of the panel away from the base and pull up on panel to allow the side panel tabs to pull out of the side panel slots.
3. Set the panel in a safe place to prevent damage.
4. Reinstall panels in the reverse order.

NOTE: left and right-side panels can only be installed as shown. Louvers must be near the end of case for the tabs to align with side panel slots. Be sure all (3) tabs are engaged into side panel slots.

## Base Component Layouts Self Contained IMSS60 & IMSS84

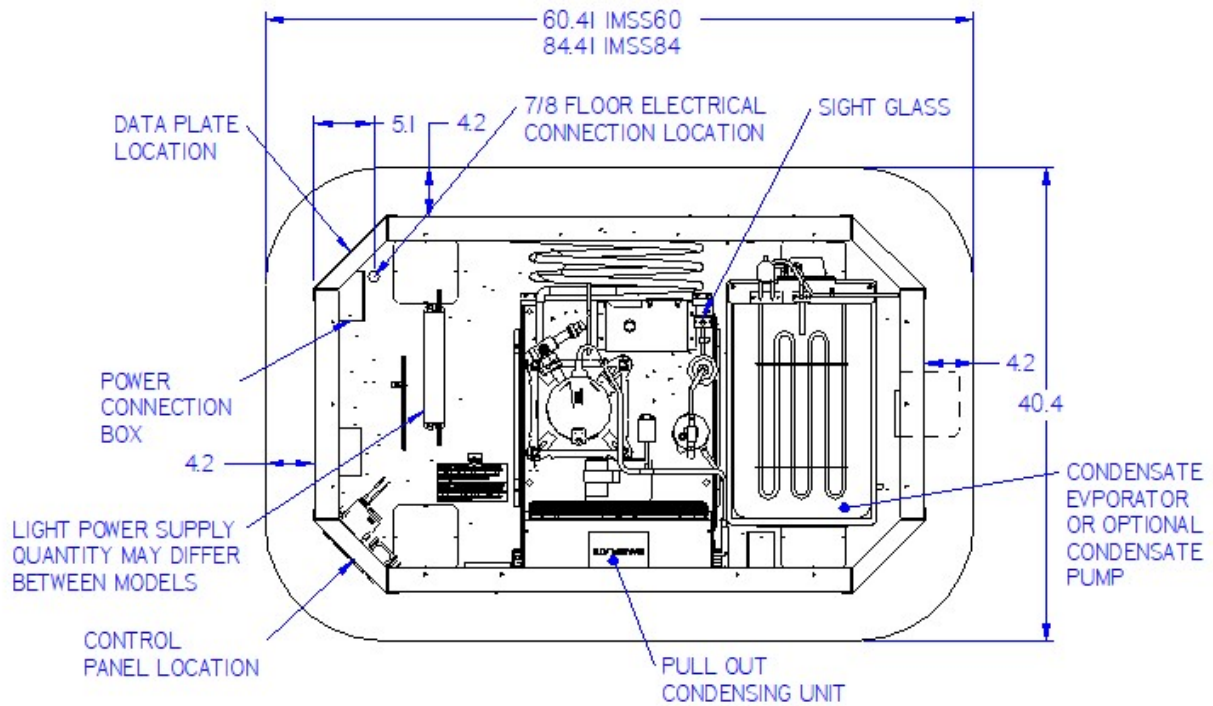

## Base Component Layout Remote IMSS60 & IMSS84

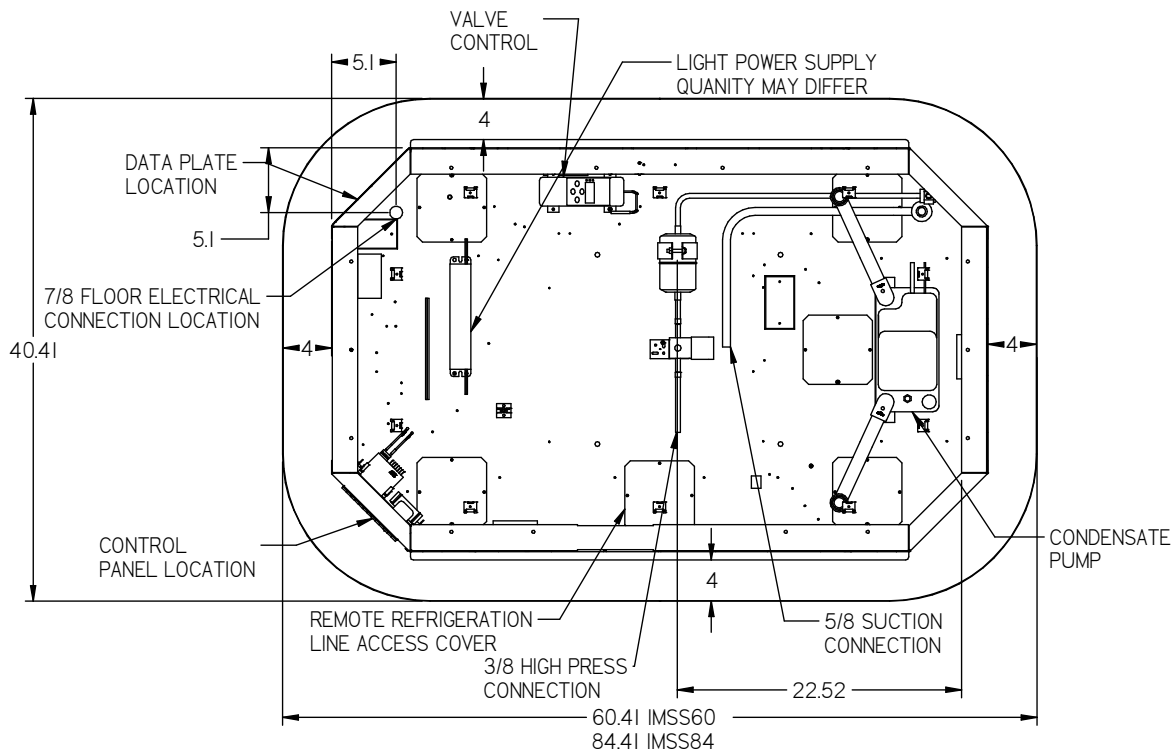

## Base Component Layout Self Contained IMSS120

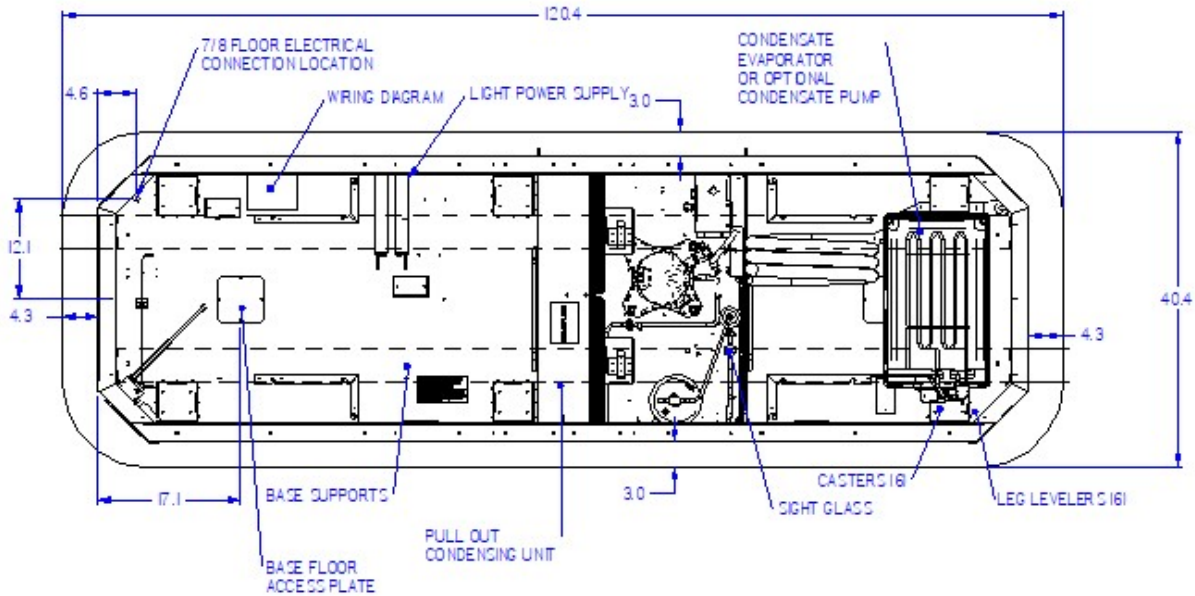

## Base Component Layout Remote 120

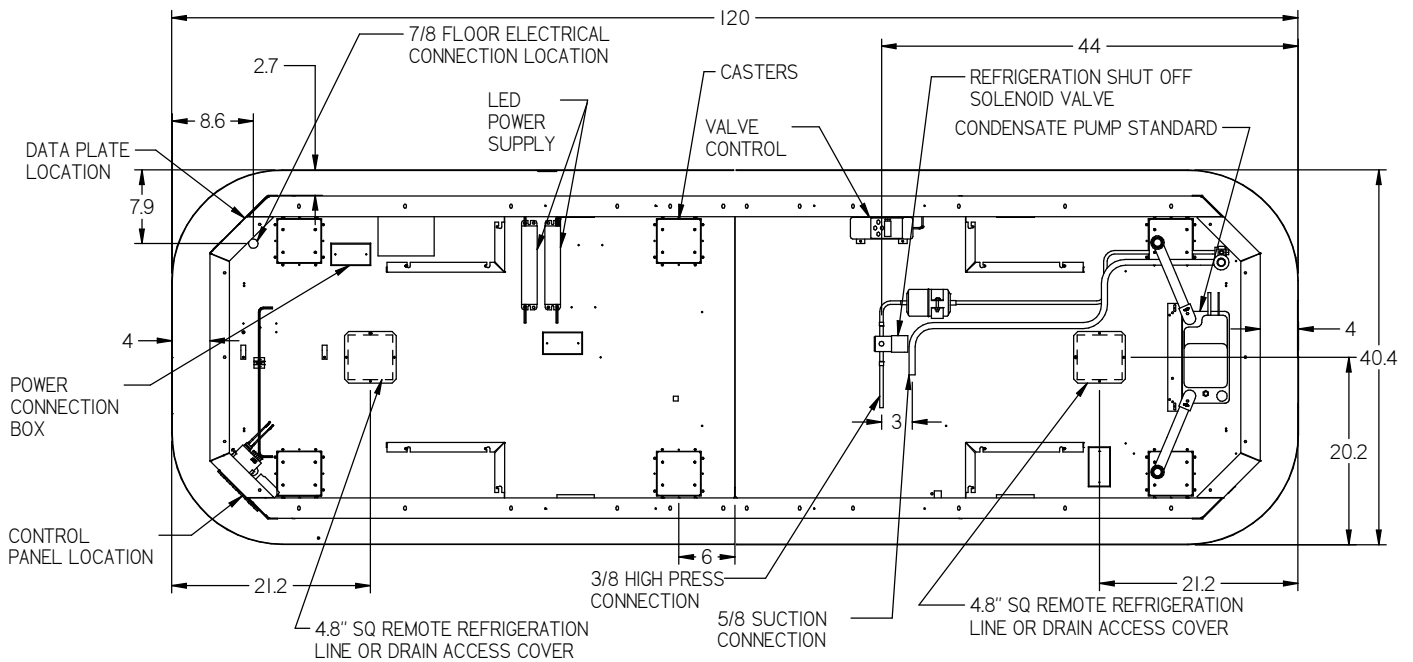

## Condensate Evaporator Pan (Standard 3 Shelf Self Contained Models)

**IMPORTANT:** Read this Section of this manual located on page 5.

“REFRIGERATION WARNING & INSTALLATION-REPAIR-DECOMMISSIONING”

All refrigeration and electrical work must be performed by certified technicians.



**NOTICE:** This is an open-air merchandiser and can produce a large amount of condensate water. During normal defrost cycles, steam from the condensate evaporator may be visible around the case.

**Do not use other means to defrost coil other than recommended by manufacturing**

The standard Self-Contained case is furnished with an electric condensate evaporator. Plumbing connections are not required.

Make sure that the drain line has not been dislodged during shipment and that the drain trap terminates properly over the water reservoir.

The condensate evaporator can be removed from the case and the drain lines can be plumbed to a drain or a condensate pump to conserve energy. A licensed electrician will need to disconnect the condensate evaporator wires.

## Condensate Evaporator Pan Shipped Loose (OPTION)

If the optional high output condensate pan was ordered it will be shipped loose in a separate box. This high output pan must be field mounted and wired by a licensed electrician.

If there is already a factory condensate pan and mounting brackets installed in the base compartment they must be removed before installing the optional high output pan.

Unwire the heater wires from the 2x 4 electrical box and cap remaining wire ends with UL approved wire nuts. **NOTE: THESE WIRES CAN NOT BE CONNECTED TO THE FIELD INSTALLED HIGH OUTPUT PAN.**

Mount the high output condensate pan inside the base compartment so that the (2) condensate drain tubes drain directly into the pan as shown in photo.

The field installed high output condensate pan must be wired to its own designated circuit breaker and **cannot** be wired into the same circuit breaker that the display case uses. The display case circuit and wiring are not sized to handle the extra amperage of the high output condensate pan.

See label on condo pan for proper circuit sizing.

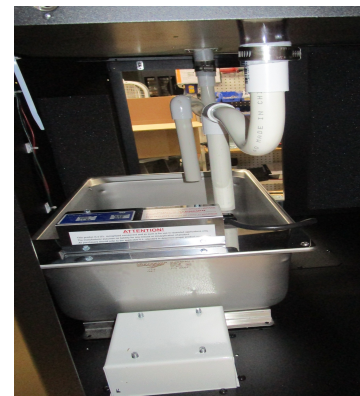

- Bottom Electrical (standard): There is a cord and plug provided on the high output condensate pan. A licensed electrician must provide a designated receptacle to plug in the high output condensate pan. There are access holes in various locations in the base enclosure to run wires out of the case to electrical source.

-Top Electrical (optional): There is also a top wiring condensate pan option that provides a top electrical box on the top side of the canopy. This allows wires to be run to the store ceiling. There are (2) sets of wires, “main case wiring” and “condensate pan wiring”. Each circuit is labeled and must run to separate circuits. The condensates pan wires run down through the case into a 2 x 4 electrical box in the base compartment. A licensed electrician will need to provide a designated receptacle to plug in the high output condensate pan.

## **Condensate Pump** Standard - Remote & 2 Shelf Self-Contained Optional - 3 Shelf Self Contained

The pump is mounted in the base compartment and is designed to automatically remove the condensate water that collects from defrosting the evaporator coil. The pump has a built-in tank that collects water from the evaporator coil defrost cycle. When the pump tank is full the pump switches on and pumps water to a remote location for disposal. When the tank is empty the pump automatically switches off. The pump is capable of lifting water to a maximum of 20'.

### **Condensate Discharge Hose.**

The case is provided with a 25' of 3/8ID clear flexible tubing. Depending on options it is either coiled up on top of the case or in the base compartment.

#### **Hose Coiled in Base**

**Disconnect Power:** Access the hose located in base compartment by removing one of the base side panels. The hose can be routed to the nearest remote drain through one of the provided openings or holes. Do not run hose in heavy traffic areas and be sure hose does not get kinked or pinched.

#### **Hose Coiled on Top**

Hose coiled on top of the unit is designed to be run vertical to the ceiling before being routed to the nearest remote drain. The maximum vertical height the hose can run is 20' from floor. Once the hose turns to a horizontal direction the hose must have a downward slope to avoid low spots that water can collect. Be sure the hose does not get kinked or pinched.

## Shelves

The IMSS has solid metal shelves with LED lighting as standard.

There are (4) brackets required for each shelf (2 long brackets and (2) short brackets. The long brackets are for the long side of case and the short brackets are at the short end of case. The short bracket with cord retainer clip must be used at the short end of case where the light cord plugs in.

The shelves are adjustable in ~ 1 1/16" increments.

Allow a minimum of 2" between the top of product and bottom of shelf.

### IMPORTANT:

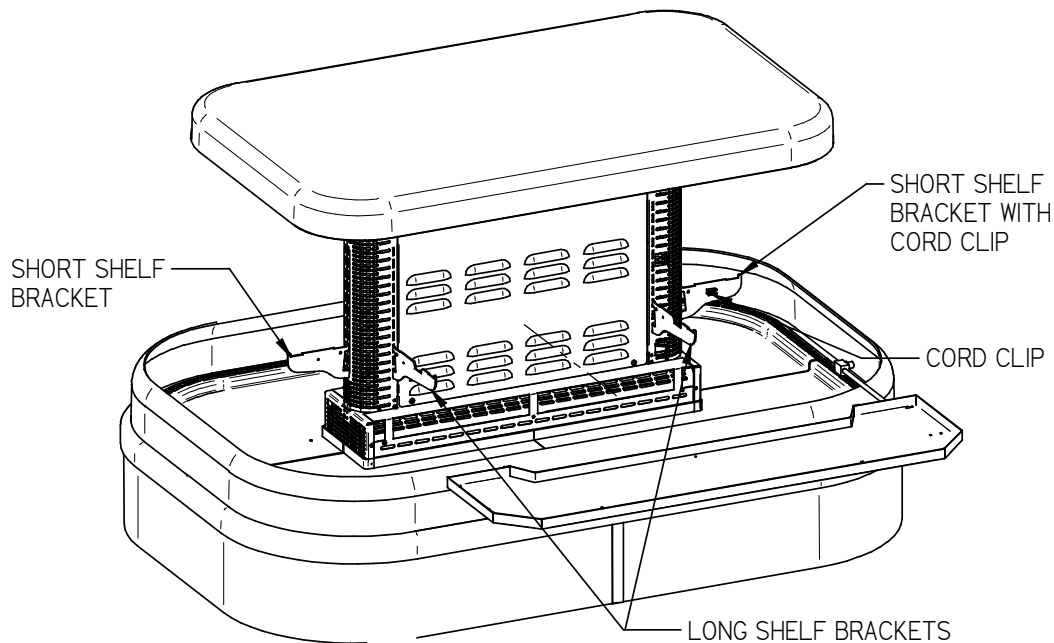

1. Turn the light switch to the off position.
2. Follow the instruction in the illustration below and insert (1) of the (4) shelf brackets in the desired tower slot on one side of the case. Place the additional shelf brackets in the same height level on the opposite end of case. The (2) short brackets must go on the short end and (2) long brackets must go on the long end. The short bracket with a shelf light cord retainer clip must be on the side with the shelf light receptacle.

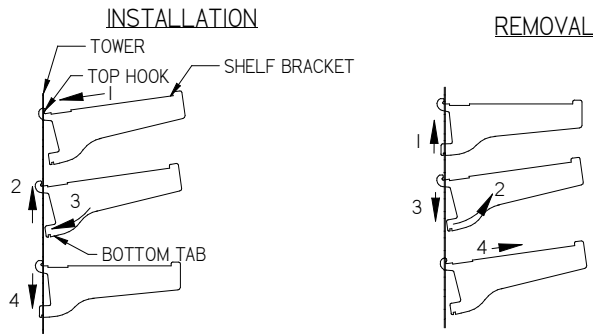

- |                                                                                                                                                                                                                                                                                                                                                      |                                                                                                                                                                                                                                                                                                                                                                         |
|------------------------------------------------------------------------------------------------------------------------------------------------------------------------------------------------------------------------------------------------------------------------------------------------------------------------------------------------------|-------------------------------------------------------------------------------------------------------------------------------------------------------------------------------------------------------------------------------------------------------------------------------------------------------------------------------------------------------------------------|
| <ol style="list-style-type: none"> <li>1. Place shelf bracket top hook into desired slot in the tower.</li> <li>2. Lift shelf bracket top hook to allow shelf bracket bottom tab to clear slot in tower.</li> <li>3. Swing shelf bracket bottom tab into tower slot.</li> <li>4. Place the shelf bracket notch onto bottom of tower slot.</li> </ol> | <ol style="list-style-type: none"> <li>1. Lift shelf bracket up to allow shelf bracket notch to clear the bottom of slot in tower.</li> <li>2. Swing shelf bracket bottom tab out of slot in tower.</li> <li>3. Drop shelf bracket down to allow shelf bracket top hook to clear the slot in tower.</li> <li>4. Remove shelf bracket top from slot in tower.</li> </ol> |
|------------------------------------------------------------------------------------------------------------------------------------------------------------------------------------------------------------------------------------------------------------------------------------------------------------------------------------------------------|-------------------------------------------------------------------------------------------------------------------------------------------------------------------------------------------------------------------------------------------------------------------------------------------------------------------------------------------------------------------------|

3. Set the shelf on to the brackets and place the bracket retainer clip into slots on shelf.
4. Push shelf light cords into plastic shelf cord retainer clip located on inside of shelf bracket.
5. The shelf light cords are attached to the tower and there is no longer a female connector in the tower. Once the shelf is in the desired location, the shelf light cord can be plugged into the LED light. The shelf light cord is adjustable, the cord can be pushed into or pulled out of the tower to get desired length.

6. Place extra cord into cord clip as shown to keep it out of the way.

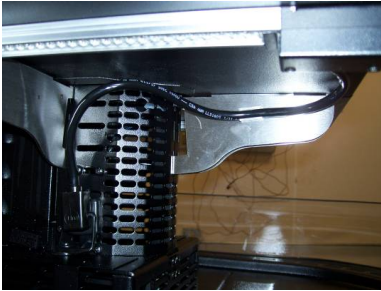

7. Removal of shelving is performed by following steps in reverse order.

# OPERATING INSTRUCTIONS

## User Controls

ELECTRONIC CONTROL / DISPLAY

POWER SWITCH

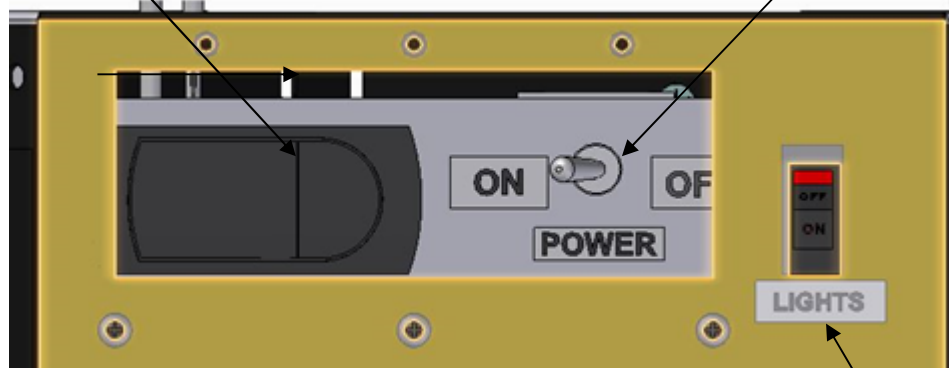

LIGHT SWITCH

### Power Switch

The unit has a power switch that turns off power to the entire unit, including the condensate evaporator and the lights. This switch is located behind a lift up panel on the unit base.

### Light Switch

The unit has a light switch that turns on and off the interior lights of the unit. This switch is located below the lift up panel on the unit base.

### Electronic Control

This control is located behind a lift up panel on the unit base.

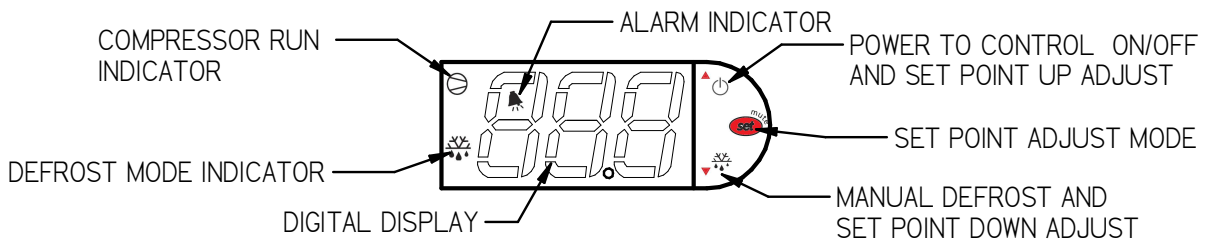

## Using Electronic Temperature Control (Refrigerated Models Only)





### Button Overview

	<p><b>Press and hold this button for 3 seconds to turn system on (if off) or off (if on). Also used to adjust set point when in set point adjust mode</b></p>
	<p><b>Press to enter set point adjust mode, confirm set point changes, and mute alarms.</b></p>
	<p><b>Press and hold this button for 3 seconds to initiate a manual defrost (and cancel defrost if initiated), also adjusts set point down when in set point adjust mode</b></p>



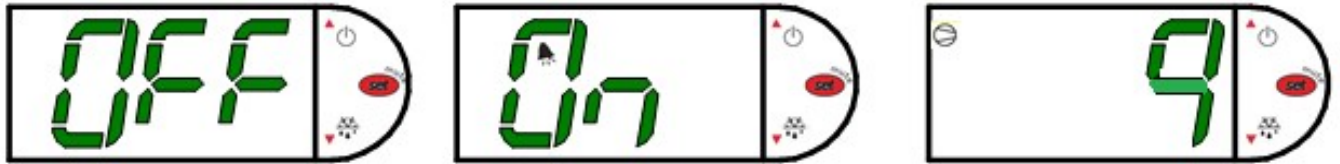

## Powering on control

To turn refrigeration control power on, press and hold  for approx. five seconds. The display will read “On” while the button is depressed. When the control powers on, the display will read the current set point numbers 1 thru 9. The compressor run indicator  will illuminate on the display, meaning that the compressor is running. (Note: the control may already be in the on mode when shipped from factory).

To turn refrigeration control power to off, press and hold  for approx. five seconds. The display will read “Off” while the button is depressed. When the control powers off the display will flash back and forth between the current set point and “Off”. The compressor run indicator  will be off on the display. When refrigeration control is in the off-mode cabinet lights and evaporator fans will still operate, but the compressor will not turn on causing the case to gradually reach room temperature.





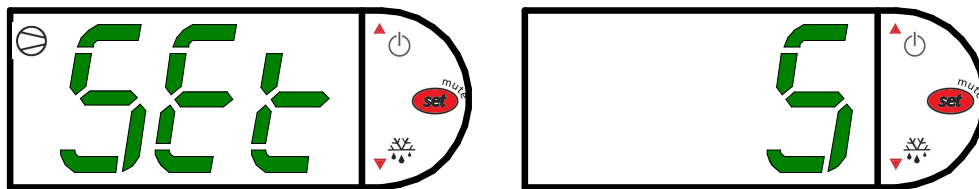

## Adjusting the set point

The set point is what determines how cold the display case will hold food and beverage. To adjust the set point press and hold the  button approx. 5 seconds until the display begins to flash a number. Then press the  button to scroll number up (colder) or press the  button to scroll number lower (warmer). There are nine (9) available set point numbers, the higher the number of the set point, the colder the display case will run, with setting “9” being the coldest and setting “1” being the warmest. Once you have chosen your desired setting press the  button again to confirm your choice.



## Entering manual defrost mode

To initiate a manual defrost press and hold the  button approx. 5 seconds. The control will read “dEF” while the button is being held. The defrost is initiated when the defrost mode indicator  illuminates on the display. The control display will then return to reading the set point. when the defrost mode indicator  turns off the defrost is complete and the compressor will turn back on illuminating the compressor run indicator  .



## Error codes

It is possible for error codes to be displayed on the control screen. In the event of a malfunction an alarm will sound and the alarm indicator  will be displayed on the display. An error code or codes will flash intermittently on the display. If there are multiple codes, the display will continuously cycle through them. The following photo shows error code “E0” as an example.



**Mute:** You may mute the alarm by pressing and releasing the wrench button. The red ringing bell and all error codes will still be displayed. When the fault is remedied the control will return to normal operation and will automatically clear the codes from the display.

## Carel Control

E0 = Air sensing probe - Open or shorted

E1 = Evap. coil probe - Open or shorted

Code	Description	Cause	Resolution
E0	Temperature probe error	Probe signal is interrupted or short-circuited	Check to ensure probe wires and quick disconnect are secure in control.  Check probe resistance to table below. If 0 resistance is present check wiring insulation. If infinite resistance is present check for breaks in wiring (meter will likely read overload or very high in the mega-ohm range).  Ensure that probes are wired per the wiring diagram provided.  Replace probe if other remedies fail, or if probe resistance deviates from “Table 3” below
E1	Defrost probe error	See E0	
EE	Unit parameter reading error	Operating conditions	Remedy abnormal operating conditions. The control is rated to operate in a range of 14 to 122°F (-10 to 50°C) and less than 90%RH non-condensing.  Replace control if problem persists.
EF	Operating parameter reading error	See EE	

## **Initial Start-Up**

After all the checks outlined in the installation section of this manual have been made, the case is ready to be put into service. Turn on the Power at the breaker box and flip the Power Switch and Light Switch on unit to the on position. At start up from a warm unit, it is recommended that the temperature control is set at a warm setting, such as After the unit has gone through several cycles, change the control to a mid-range setting, then to a colder setting if necessary to maintain desired product temperature



**NOTICE: This refrigerated display case is designed to operate in a maximum environment of 75 DEG. F and 55% relative humidity. Exceeding these limits will cause poor case performance, excessive sweating & overflow condensate pan.**

## **Placing Product into Case**

- Do not exceed 75 pounds of weight per shelf. Heavy product should be distributed evenly across the entire shelving area.
- Determine desired shelving location before placing product in case. Product must be removed to readjust shelf location.
  - \*Do not store explosive or flammable substances in this appliance. (such as aerosol cans).
- Allow a minimum of 2" between the top of product and bottom of shelf.
- Do not overhang the front or rear of shelves with product. Improper clearance in front and the rear of shelf will block the refrigerated airflow and will cause product loss.
- Do not block the slots along the front and rear air discharge slots. Covering these slots will block the refrigerated airflow and could cause product loss.
- The display deck is removable for cleaning and can become dislodged in shipment. To ensure proper airflow and performance of the case, make sure that the display deck is pushed completely down.
- Allow refrigerated models to run for at least two hours before placing pre-chilled product into unit.



**NOTICE: CASE MUST BE STOCKED WITH PRE-CHILLED PRODUCT ONLY.**

---

---

# **CLEANING INSTRUCTIONS**

---

---

## **Acrylic Air Deflector Cleaning**



**NOTICE: Clear acrylic air deflector requires special washing procedures to prevent hazing and yellowing of material.**

**NEVER USE** paper towels (wet or dry) for cleaning or drying and never use a dry towel.

**NEVER USE** a glass cleaner of any kind.

Lightly dust (not wipe) surface with a damp Microfiber towel or chamois. The surface can then be washed using a small amount of dishwashing detergent such as Dawn or Joy and lukewarm water. Use a Microfiber towel or chamois, applying only light pressure. The cloth or chamois must be kept free of grit by frequently rinsing. Rinse the surface with clear water and dry by blotting with a damp Microfiber towel or chamois.

## Daily Cleaning

The case should be cleaned thoroughly, as described in the weekly cleaning section, before it is used for the first time.



**NOTICE:** Avoid splashing or soaking any electrical components with water to prevent electrical damage to the case.



**NOTICE:** Shut off lights and power switches and remove all products from the case. Allow sufficient time for the unit to reach room temperature before proceeding with cleaning.



**NOTICE:** Remove all products from the case before proceeding with cleaning procedure.



**NOTICE:** Acrylic air deflector requires special washing procedures to prevent hazing and yellowing of material. Clean as described in “Acrylic Air Deflector Cleaning” section of this manual.

**Note:** For major spills or foreign material buildup use complete weekly cleaning instructions.

**Note:** Detergents are not recommended and do not use abrasive cleaners or pads to prevent scratching of surfaces.

1. Dip rag in warm soapy water and ring out thoroughly. Wipe the entire interior of case and dry with soft dry towel.
2. The remaining exterior surface should be wiped down using any ammoniated cleaners or soapy warm water and dried with soft dry towel.
3. **IMPORTANT:** Cleaning the clear acrylic plastic front air deflector. Clean as described in “Acrylic Air Deflector Cleaning” section of this manual.

## Weekly Cleaning



**NOTICE:** Avoid splashing or soaking any electrical components with water to prevent electrical damage to the case.



**NOTICE:** Shut off lights and power switches and remove all products from the case. Allow sufficient time for the unit to reach room temperature before proceeding with cleaning.



**NOTICE:** Remove all products from case before proceeding with cleaning procedure.



**NOTICE:** Acrylic front air deflector requires special washing procedures to prevent hazing and yellowing of material.

**Note:** Detergents are not recommended and do not use abrasive cleaners or pads to prevent scratching of surfaces.

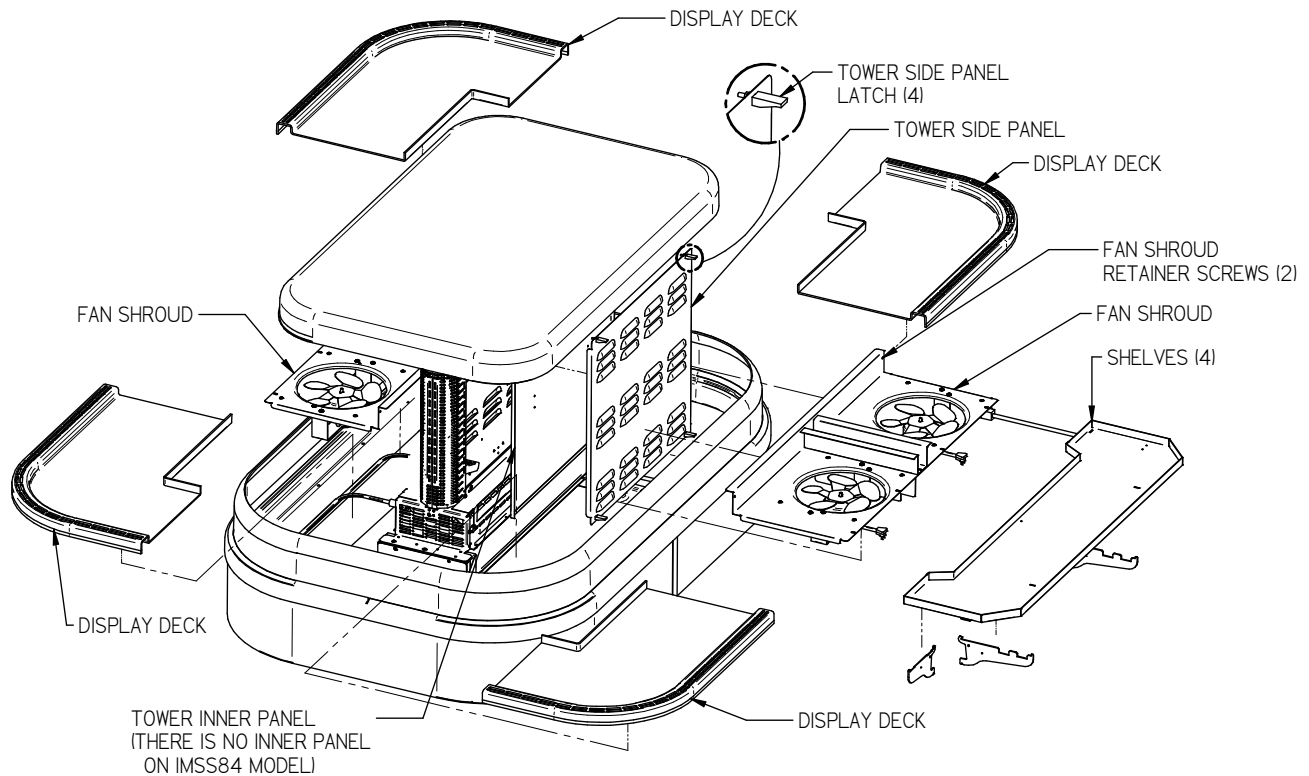

ILLUSTRATION IS TYPICAL,  
SOME MODELS MAY HAVE MORE PANELS, SHELVES AND DISPLAY DECKS

1. Remove interior shelving from unit as described in the “Shelving Installation and Removal” section of this manual.
2. Dip rag in warm soapy water and ring out thoroughly. Clean all shelves and shelf brackets and dry with soft dry towel.
3. Remove tower side panels by lifting (4) latch levers and pulling tower side panel out away from tower.
4. Remove the tower inner panel by lifting panel up until retaining pins clear key slots hole. Pull panel out of tower.
5. Dip rag in warm soapy water and ring out thoroughly. Clean the tower side panels, tower inner panels and inside both tower ends. Dry with soft dry towel
6. Lift the display decks up and out of evaporator tub.
7. Remove the fan shroud assembly by removing (4) retaining screws from the outer flange and (2) from the inner flange. Lift the fan shroud assembly and reach in and unplug the evaporator fan motor cord(s). Lift fan shroud assembly out of tub.
8. Clean the display deck(s) using warm soapy water and a brush. Rinse thoroughly and allow dry. Wipe off fan shroud assembly (do not rinse or submerge fan motors).
9. Clean the entire interior of the case using warm soapy water. Wipe off all soapy water with a damp cloth and allow it to dry. (DO NOT use solvents such as Acetone, Benzene, Carbon Tetrachloride, and Lacquer Thinners)

**10. IMPORTANT: Cleaning the clear acrylic plastic front air deflector. Clean as described in “Acrylic Air Deflector Cleaning” section of this manual.**

11. Reassemble all components in reverse order.

NOTE: Depending on the amount of usage and spillage of foreign material, some fasteners may have to be removed, and parts disassembled to allow proper cleaning of the unit.

# MAINTENANCE

**IMPORTANT:** Read this Section of this manual located on page 5.  
“REFRIGERATION WARNING & INSTALLATION-REPAIR-DECOMMISSIONING”  
All refrigeration and electrical work must be performed by certified technicians.

## Cleaning Condenser Coil



### NOTICE:

**Condenser coil or optional air filter must be cleaned a minimum of twice per month to ensure proper refrigeration performance and prevent compressor failure. In some environments it may be necessary to clean more frequently. FAILURE TO CLEAN CONDENSER COIL WILL VOID COMPRESSOR WARRANTY.**

It is very important that the Condenser coil or optional air filter is cleaned twice per month to ensure proper refrigeration performance and to prevent compressor failure. In some environments, it may be necessary to clean more frequently. Failure to clean condenser coil will void condenser warranty. This procedure is for Self-Contained models. The remote condenser coil must also be cleaned at the same intervals.

1. Disconnect power to the unit.
2. On IMSS60 and IMSS84 Remove the side panel with the narrow set of louvers and on IMSS120 remove panels from both sides at the end the control panel is located. See the illustration in the “Bottom Panel Removal” section of this manual for panel clarification.

Carefully vacuum the front surface of condenser coil. Take care not to bend coil fins with vacuum cleaner nozzle.

-If equipped with optional air filter remove filter and carefully vacuum the front surface of condenser coil. Take care not to bend coil fins with vacuum cleaner nozzle. Wash filter using warm soapy water, rinse, and let dry. Apply a generous coat of filter coat adhesive to both sides of filter. (Filter coat adhesive is available through any restaurant supply distributor.) Recommended Super Filter Coat

**NOTE: Failure to coat filter with a fresh coat of filter adhesive after cleaning will prevent filter from working properly. Failure to do so will allow the condenser coil to plug, which will affect refrigeration performance and could cause compressor failure.**

3. Reinstall side panel(s).

VACUUM FRONT  
SURFACE OF  
CONDENSER COIL



---

---

# SERVICE INFORMATION

---

---

**CAUTION**  
RISK OF ELECTRIC SHOCK  
  
DISCONNECT POWER BEFORE  
SERVICING UNIT

**Before any service work  
is performed on the  
case, make sure all  
power is disconnected  
to the case.**

**IMPORTANT:** Read this Section of this manual located on page 5.  
“REFRIGERATION WARNING & INSTALLATION-REPAIR-DECOMMISSIONING”  
All refrigeration and electrical work must be performed by certified technicians.

To find a service company in your area, please visit our website at [www.federalindustries.com](http://www.federalindustries.com). There you can also find self-service tools to help you get the answers you need faster!

For Warranty Service Requests & ALL Technical Support please contact:

- Phone: (800) 356-4206 and choose the Tech Support/Warranty Option
- Email: [Service@federalind.com](mailto:Service@federalind.com)

For Warranty Compressors please contact the Parts Department:

- Phone: (800) 356-4206 and choose the Warranty Parts Option
- Email: [Parts@Federalind.com](mailto:Parts@Federalind.com)



Federal Industries has partnered with Parts Town for ALL Non-Warranty Part Identification, Pricing, Lead Times, Orders & Freight Quotes. Please contact Parts Town directly if you need parts:

- Website: [PartsTown.com](http://PartsTown.com)
- Email: [CustomerService@PartsTown.com](mailto:CustomerService@PartsTown.com)
- Phone: 833-809-8188

## **Pre-Service Checklist**

You may avoid the cost and inconvenience of an unnecessary service call by first reviewing this checklist of frequently encountered situations that can cause unsatisfactory case performance.



**CAUTION:** Before servicing the case, turn off power at the main breaker of fuse box.

### ***Case Does Not Operate***

Check for disconnected power supply.  
Check for tripped breaker on blown fuse.  
Check that the thermostat display is on and that the green indicator light is lit.

### ***Lights Do Not Operate***

Check that the light switch is on.  
Check for tripped breaker or blown fuse.  
Check that light housing cords are plugged in correctly to sockets in the tower

### ***Case Temperature Too Warm***

Check that the cold air inlet and outlet slots are not blocked.  
Check for a blocked or dirty condenser coil.  
Check for cold airflow. Lack of adequate cold airflow could indicate a defective evaporator fan or a blocked evaporator coil. Check that paper or foreign materials are not blocking the evaporator. If the evaporator coil is blocked due to excessive frost, put it into manual defrost. Excessive frost can build up overtime if the case is set too cold or if there is excessive humidity in the store.  
Check all the fans in the evaporator compartment and tower are running.

### ***Case Sweating Note:*** Some interior sweating is normal on this case.

Check room ambient – Case is designed to operate in an environment not to exceed 75°F and 55% relative humidity.  
Check all the fans in the evaporator compartment and tower are running.

### ***Overflow of Condensate Pan***

Check that the drains in bottom of tub floor is not plugged.  
Check that drains trap to the condensate pan is not plugged

### ***Overflow of Optional Condensate Pump:***

Check that the drains in bottom of tub floor is not plugged.  
Check that drains trap to the condensate pan is not plugged  
Check that drains lines from pump are not plugged or pinched.  
Check to see that pump float is operating correctly.  
Verify that pump is plugged in and has power.  
Replace pump if still not pumping condensate.

## **Special Service Situations**

**IMPORTANT:** Read this Section of this manual located on page 5.  
“REFRIGERATION WARNING & INSTALLATION-REPAIR-DECOMMISSIONING”  
All refrigeration and electrical work must be performed by certified technicians

There are rare occasions when the refrigerant charge must be evacuated from a case to perform service work. In those situations, Federal Industries recommends that the refrigerant charge be evacuated into a recovery system to prevent the possibility of hydrofluoro olefin (HFO) from being released into the atmosphere.

The release of HFO into the atmosphere is a potential source of global warming. Note the condensing unit that was supplied with this case has a receiver tank large enough to hold all the charge you may be able to pump down the system when service is required.

If moisture or liquid is observed around or under a Federal Industries case, an immediate investigation should be made by qualified personnel to determine the source of the moisture or liquid. The investigation made should determine if the case is malfunctioning or if there is a simple housekeeping problem.

Moisture or liquid around or under a case is a potential slip / fall hazard for persons walking by or working in the general area of the case. Any case malfunction or housekeeping problem that creates a slip / fall hazard around or under a case should be corrected immediately.

---

---

# SALE & DECOMMISSIONING

---

---

**IMPORTANT:** Read this Section of this manual located on page 5.  
“REFRIGERATION WARNING & INSTALLATION-REPAIR-DECOMMISSIONING”  
All refrigeration and electrical work must be performed by certified technicians

If you, the owner sells or gives away this Federal Industries case, it is the owner's responsibility to make sure that all safety labels and the Installation-Service Manual are included with it. If you need replacement labels or manuals, Federal Industries will provide them free of charge. Contact the customer service department at Federal Industries at (800) 356-4206.

The customer service department at Federal Industries should be contacted at the time of sale or disposal of your case so records may be kept of its new location.

If you sell or give away your Federal Industries case, you should evacuate the refrigerant charge before shipment. Federal Industries recommends that the charge be evacuated into a recovery system to prevent the possibility of HFO's from being released into the atmosphere.

## **Refrigerant Recovery/Recycling/Disposal**

When recycling or discarding case, refrigerants **MUST BE** handled according to local, state and federal codes, requirements and regulations.

If disposing of a refrigerated case that uses ozone depleting chemicals in its refrigeration system, make sure the refrigerant is removed by a qualified service technician and properly disposed of.

If you intentionally release refrigerant into the atmosphere, you may be subject to fines or other penalties (under regulation mandated by environmental regulators and/or legislative edict.)

# ELECTRICAL DATA

<u>Model</u>	<u>IMSS60SC/IMSS84SC</u>		<u>IMSS60R/IMSS84R</u>	
<b><u>Power Supply, Volts</u></b>	<b><u>230 Volts</u></b>		<b><u>230 Volts</u></b>	
Frequency	60 Hertz		60 Hertz	
Phase	1 Phase		1 Phase	
Number of Wires	2 + GND		2 + GND	
	<b><u>AMPS</u></b>	<b><u>VOLTS</u></b>	<b><u>AMPS</u></b>	<b><u>VOLTS</u></b>
Compressor	12.6/12.0	230	-	-
Condenser Fan	.8	230	-	-
Base Fan	-	-	.15	230
Evaporator Fan Motor (QTY 2 or 4)	0.15 ea.	230	0.15 ea.	230
Lights Power Supply 24V	.8	230	.8	230
Condensate Pan Heater	7.8	230	-	-
Condensate Pump	-	-	.75	230

Refer to the rating plate data attached to side of base for Maximum Fuse Size and Minimum Circuit Ampacity.

<u>Model</u>	<u>IMSS120SC</u>		<u>IMSS120R</u>	
<b><u>Power Supply, Volts</u></b>	<b><u>230 Volts</u></b>		<b><u>230 Volts</u></b>	
Frequency	60 Hertz		60 Hertz	
Phase	1 Phase		1 Phase	
Number of Wires	2 + GND		2 + GND	
	<b><u>AMPS</u></b>	<b><u>VOLTS</u></b>	<b><u>AMPS</u></b>	<b><u>VOLTS</u></b>
Compressor	17.9	230	-	-
Condenser Fan (QTY 2)	.5 ea	230	-	-
Evaporator Fan Motor (QTY 6)	0.15 ea.	230	0.15 ea.	230
Lights Power Supply 24V (QTY 2)	1.6	230	1.6	230
Condensate Pan Heater	9.0	230	-	-
Condensate Pump	-	-	.75	230

Refer to the rating plate data attached to side of base for Maximum Fuse Size and Minimum Circuit Ampacity.



---

---

# CONTROL OPERATION

---

---

## **Electronic Control**

This unit is equipped with CAREL temperature control. The control parameters are set at the factory and cannot be manually changed in the field. Control parameter changes can only be made by downloading a new set of parameters via a program chip supplied by Federal Industries. The preset control parameters are listed on the chart in the Settings Chart below.

## **Operation**

The control uses two sensors, one located in the air stream, and one located on the evaporator coil. The sensor located in the air stream is referred to as the temperature control sensor. The sensor located on the evaporator coil is referred to as the coil sensor.

The temperature control sensor is located inside the center tower at the top. The sensor location is critical for proper operation on the unit. Do not move or relocate this sensor.

The coil sensor is strapped to the evaporator coil. This sensor location is critical for proper operation of the unit. Do not move or relocate this sensor.

The temperature control is set to cut in at 39 degrees F. The Temp control cuts out at 14 degrees F at the coldest setting "9" and 28 degrees F at the warmest setting, '1' on the control display.

The temp control turns off the refrigeration system when you "press and hold" the top arrow / power button for approx. 3 seconds until "OFF" flashes on display.

Condenser fan will run continuously once power is supplied to the appliance.

## **Defrost Cycle**

The CAREL control is programmed to initiate defrost via two different methods. There are 3 programmed defrost cycles in the case which will initiate a defrost cycle every 8 hours. The unit does not have a time clock so the defrost cycles cannot be set for any specific time of day.

The unit also has an 'On demand' defrost feature that will initiate a defrost when the temperature differential between the evaporator temperature and the air temperature is more than 15 degrees for 5 minutes after 30 minutes into the refrigeration cycle.

The unit is equipped with a maximum run timer that is preset at the factory for 75 minutes on. If the temperature control does not reach the cut out set point after running for one hour, the timer will turn the compressor off for a minimum of 2 minutes.

Do not use other means to accelerate the defrosting cycle process other than those recommended by the manufacturer.

## CONTROL PARAMETERS IMSS60 & 84 SELF-CONTAINED

**Table 1 - Control Parameters**

Parameter Description									
Control Setpoint →	1	2	3	4	5	6	7	8	9
<b>Compressor Cut out [°F]</b>	28.0	26.2	24.5	22.7	21.0	19.2	17.5	15.7	14.0
<b>Compressor Cut in [°F]</b>	39.0°								
<b>Compressor Min On Time</b>	5 min								
<b>Compressor Min Off Time</b>	2 min								
<b>Compressor Max Run Time</b>	75 min								
<b>Defrost Termination Temp [°F]</b>	43.0								
<b>Time to first defrost</b>	8 hr.								
<b>Time to subsequent defrost</b>	8 hr.								
<b>Maximum Defrost duration</b>	30 min								
<b>Defrost on demand differential [°F]</b>	15.0								
<b>Delay for defrost on demand</b>	5 min								
<b>Time delay to the next defrost on demand</b>	30 min								

**Table 2 - Temperature Probe Common Resistance Chart**

Probe Temp	Maximum Resistance [Ω]	Normal Resistance [Ω]	Minimum Resistance [Ω]
32°F (0°C)	27.83	27.28	26.74
77°F (25°C)	10.1	10	9.9
212°F (100°C)	1	0.97	0.94



## CONTROL PARAMETERS IMSS120 SELF-CONTAINED

Table 3 - Control Parameters

Parameter Description									
Control Setpoint →	1	2	3	4	5	6	7	8	9
Compressor Cut out [°F]	32.0	30.5	29.0	27.5	26.0	24.5	23.0	21.5	20.0
Compressor Cut in [°F]	39.0°								
Compressor Min On Time	5 min								
Compressor Min Off Time	2 min								
Compressor Max Run Time	75 min								
Defrost Termination Temp [°F]	43.0								
Time to first defrost	8 hr.								
Time to subsequent defrost	8 hr.								
Maximum Defrost duration	30 min								
Defrost on demand differential [°F]	15.0								
Delay for defrost on demand	5 min								
Time delay to the next defrost on demand	30 min								

Table 4 - Temperature Probe Common Resistance Chart

Probe Temp	Maximum Resistance [Ω]	Normal Resistance [Ω]	Minimum Resistance [Ω]
32°F (0°C)	27.83	27.28	26.74
77°F (25°C)	10.1	10	9.9
212°F (100°C)	1	0.97	0.94

## CONTROL PARAMETERS ALL 1MSS REMOTES

Table 5 - Control Parameters

Parameter Description									
Control Setpoint →	1	2	3	4	5	6	7	8	9
Compressor Cut out [°F]	30.0	28.0	26.0	24.0	22.0	20.0	18.0	16.0	14.0
Compressor Cut in [°F]	38.0°								
Compressor Min On Time	5 min								
Compressor Min Off Time	2 min								
Compressor Max Run Time	60 min								
Defrost Termination Temp [°F]	43.0								
Time to first defrost	6 hr.								
Time to subsequent defrost	6 hr.								
Maximum Defrost duration	30 min								
Defrost on demand differential [°F]	18.0								
Delay for defrost on demand	5 min								
Time delay to the next defrost on demand	30 min								

Table 6 - Temperature Probe Common Resistance Chart

Probe Temp	Maximum Resistance [ $\Omega$ ]	Normal Resistance [ $\Omega$ ]	Minimum Resistance [ $\Omega$ ]
32°F (0°C)	27.83	27.28	26.74
77°F (25°C)	10.1	10	9.9
212°F (100°C)	1	0.97	0.94

# REFRIGERATION OPERATION

**IMPORTANT:** Read this Section of this manual located on page 5.  
 “REFRIGERATION WARNING & INSTALLATION-REPAIR-DECOMMISSIONING”  
 All refrigeration and electrical work must be performed by certified technicians

## Self-Contained Models R454C

Refrigeration R454c Charge IMSS60	<b>4.5 Pounds</b>
Refrigeration R454c Charge IMSS84	<b>4.5 Pounds</b>
Refrigeration R454c Charge IMSS120	<b>6.5 Pounds</b>

The self-contained models are shipped from the factory with a completely operational R454C refrigeration system and require no modifications or adjustments upon installation. Case must be installed as per the installation section of this manual to provide proper condensing air cooling.

### **Self-Contained Refrigeration Operation**

The unit temperature is controlled by the electronic control and timers outlined in the control section of this manual. Condenser

Note: The condenser fan runs continuously.

## Remote Models

### **BTU Requirements**

IMSS60R	12,800 BTU'S @20F EVAP / 90F Ambient
IMSS84R	16,400 BTU'S @20F EVAP / 90F Ambient
IMSS120R	25,200 BTU'S @20F EVAP / 90F Ambient

### **Pressure Control Settings**

- Use pressure gauges to set pressure control.

Refrigeration R449A Charge	<b>CHARGED IN FIELD</b>
Remote Low Press. Switch Cut In	50 psi
Remote Low Press. Switch Cut Out	15 psi
Adjustable Head Master	200 psi
Remote High Press. Switch Cut Out	400 psi

The remote models are designed to use R449A refrigerant and shipped from the factory with the evaporator coil, expansion valve, sight glass and refrigerant solenoid valve. Drier filter must be installed in the field for proper operation. Electronic control runs identical to the Self-Contained models except the electronic control opens and closes a refrigeration solenoid valve located on the suction line instead of turning on and off a compressor. The solenoid valve closes and shuts off the refrigeration flow to the unit and initiates a pump down cycle. This will allow the remote low-pressure switch to open and shut off the remote compressor.



The condensing unit and pressure controls are optionally supplied from the factory for remote location installation. The condensing unit must be mounted and wired by the installer. The high low-pressure switch must be wired in series with the compressor power supply as shown in diagram on the next page.

## **Remote Condensing Unit Installation**

**IMPORTANT:** Read this Section of this manual located on page 5.

**“REFRIGERATION WARNING & INSTALLATION-REPAIR-DECOMMISSIONING”**

All refrigeration and electrical work must be performed by certified technicians

1. Mount condensing unit as close as possible to the remote display case as practical. Follow condensing unit manufacturer guidelines for proper piping and distance requirements.
2. All refrigeration and/or electrical materials between the condensing unit and display case are to be supplied by installing contractor.
3. Route properly sized and designed refrigeration lines from the condensing unit to the cabinet.

Horizontal suction lines should be pitched downward towards the condensing unit at least ½” per 10’ run to aid the oil drainage. A “P” trap must be installed in the suction line at the foot of every riser to insure oil return. Dry nitrogen must be used to flow through tubing while brazing refrigeration lines.

4. The suction line must be insulated the entire length with Armaflex (or equivalent). Do not run liquid line inside insulation with suction line.
5. The remote high/low-pressure control must be mounted, wired and set pressures by the installer.
6. Leak check condensing unit, cabinet, and all connecting tubing. Cabinet and condensing unit tubing should be checked using leak detecting equipment to ensure no leaks occurred during shipping or from rough handling.

Make certain all refrigeration valves are opened and evacuate system to 500 microns. Charge the system with refrigerant type specified on the data plates.

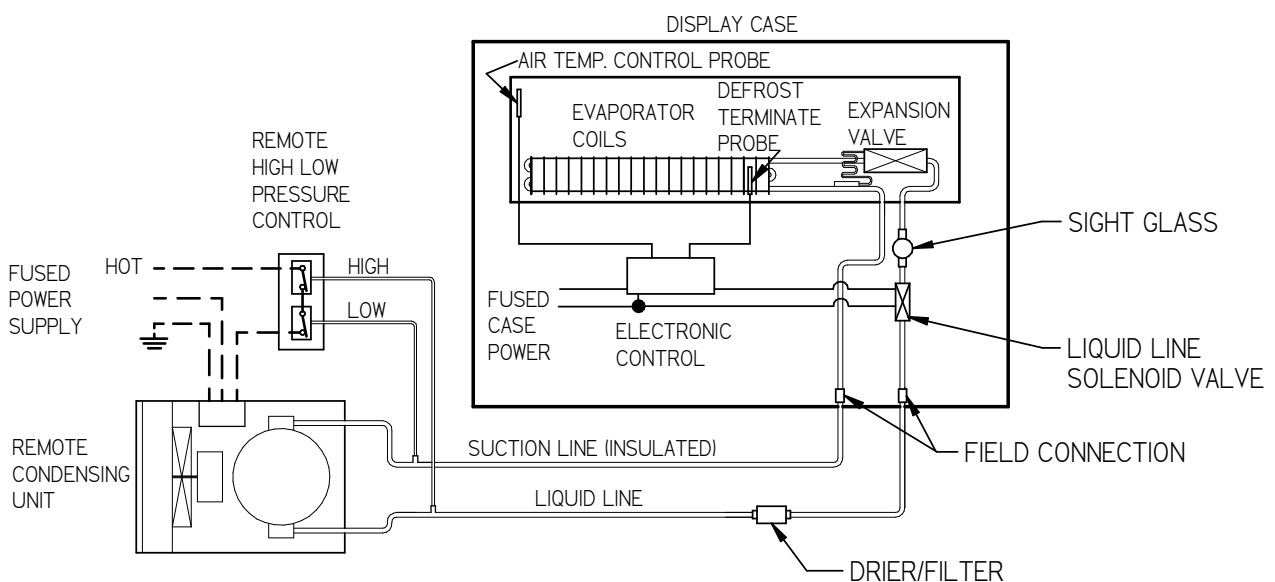

## Electronic Expansion Valve (EEV)

A traditional TXV uses springs and a temperature bulb to open and close a valve port that controls the flow of refrigerant entering the evaporator coil. An electronic expansion valve (EEV) controls the refrigerant flow much more precisely, increasing the performance and efficiency of the refrigeration system. The EEV controls the flow of Refrigerant by opening and closing the valve port based on the response to signals sent to the EEV by an electronic controller. The electronic Control bases these signals by processing information provided from a temperature sensor and pressure transducer located on the discharge side of the evaporator coil. These sensors monitor the evaporator superheat and protects the compressor from any liquid flood back under low superheat conditions.

## **EEV Controller Settings**

The electronic expansion valve controller also allows the use of different types of refrigerants without the need to change the expansion valve.





The controller is set from the factory to run on 449A refrigerant and will not need any changes to the control unless another refrigerant is used.

**Note: Check your State and Local regulations for approved refrigerants for your install location. Federal Industries is not liable for any alternate refrigerants used.**





The control is located on the side of the case opposite the condo pump.

**Note: Never change any of the other setting other than the refrigerant type. It may also be necessary to change the superheat setting only when using a different refrigerant.**







Indicator lights	
	Red light - critical alarm (system is NOT running)
	Yellow light - non-critical alarm (system running)
	Green light - compressor on
	Green blinking - compressor waiting on timer to start/stop

## Changing Refrigerant

- Access the set point mode by pressing and holding the **ENTER** button until Ctl displays on the screen.
- Use the  up or  down arrows to advance through the available set points until rFG displays on the screen and press the **ENTER** button.
- Use the  up or  down arrows until the desired refrigeration displays on the screen and press and hold the **ENTER** button until rFG once again displays on the screen.
- Press the **BACK** button to return to escape the settings menu.

## Changing Superheat

- Access the set point mode by pressing and holding the **ENTER** button until Ctl displays on the screen.
- Use the  up or  down arrows to advance through the available set points until SSP displays on the screen and press the **ENTER** button.
- Use the  up or  down arrows to set the desired superheat displays on the screen and press and hold the **ENTER** button until SSP once again displays on the screen.
- Press the **BACK** button to return to escape the settings menu.

## PARTS LIST

<b>Refrigeration System</b>	IMSS60	IMSS84	IMSS120
Condenser (SC) R454c	30-21669	30-21671	30-21670
Replacement Compressor	tba	tba	tba
Evaporator Coil Left/ Right	33-19518-L/33-19518-IR	33-19287-L/33-19287-IR	33-19647-L/33-19647-IR
Expansion Valve TXV	32-20874	32-21063	32-21063
Remote EEV	32-21226	32-21226	32-21227
Sight Glass	32-54011	32-54011	32-54011
Refrigerant Filter/Drier	32-19067	32-19067	32-19067
Refrigeration Solenoid Valve (Remote)	32-19153	32-19153	32-19153
Motor Evaporator Fan	41-19070	41-19070	41-19070
Wire Harness Evaporator Motor	43-19083	43-19083	43-19735
Blade Evaporator Fan	72-12254	72-11450	72-12254
<b>Electrical Components</b>			
LED Light Bar Shelf	42-20871-38C35	42-20871-60C35	42-20871-48C35
Top & Shelf Lamp Cord	43-21543-2B	43-21543-2B	43-21543-2B
Light power Supply 24V	39-20555	39-20555	39-20555
LED Light Bar Top	42-20871-38C35	42-20871-66C35	42-20871-48C35
LED Light Bar Ends	42-20871-20C35	42-20871-20C35	42-20871-20C35
End Light Jumper	43-21264	43-21264	43-21264
Power Switch	41-13733	41-13733	41-19760
Light Switch	41-11066	41-11066	41-11066
Temp Control Self Contained	32-19865-3	32-19865-3	32-19865-7
Temp Control Remote	32-19865-71	32-19865-71	32-19865-71
Probe Temp	32-19094	32-19094	32-19209
Condensate Pan Ass'y	40-21665-3	40-21665-3	40-21665-4
Heater Condensate Pan	40-19996-1	40-19996-1	40-19997-1

Optional Power Cord	43-19090	43-19090	-
Optional Condensate Pump	47-15687	47-15687	47-15687
EEV Control	32-21223	32-21223	32-21223
EEV Temp Control Probe	32-21224	32-21224	32-21224
EEV Pressure Transducer	32-21225	32-21225	32-21225
Harness, Evap Fan Y Split		43-21712	43-21712

<b>Miscellaneous Components</b>	IMSS60	IMSS84	IMSS120
Display Deck Plastic Left/Right	15-18856-L/ 15-18856-R	15-19292-L/ 15-19292-R	15-19292-L/ 15-19292-R
Display Deck Plastic Center	-	-	15-19720
Fastener Pad Set Display Deck	77-17848/77-17849	77-17848/77-17849	77-17848/77-17849
Metal Shelf NO LIGHT	M20958-2	M20958-1	M20957-1L/M20957-1R
Air Diffuser Air Discharge	W11533-1	W11533-5	W11533-7
Shelf Bracket Long	67-21296	67-21296	67-21296
Shelf Bracket Short	67-21296-1	67-21296-1	67-21296-1
Thermometer	32-13662	32-13662	32-13662
Straight Deflector End	15-19729-1	15-19729-1	15-19729-1
Straight Deflector Side	15-19730-4	15-19730-2	15-19730-1
Acrylic Air Deflector Seal	64-19773	64-19773-1	64-19773-2
Acrylic Deck Product Stop	15-19863-1	15-19863-3	15-19863-3H/15-19863-5
Replacement Optional Condenser Air Filter	16-19228	16-19228	16-19228-1
Super Filter Coat	22-21164	22-21164	22-21164

# Case Wiring Diagrams

## Self-Contained IMSS60SC

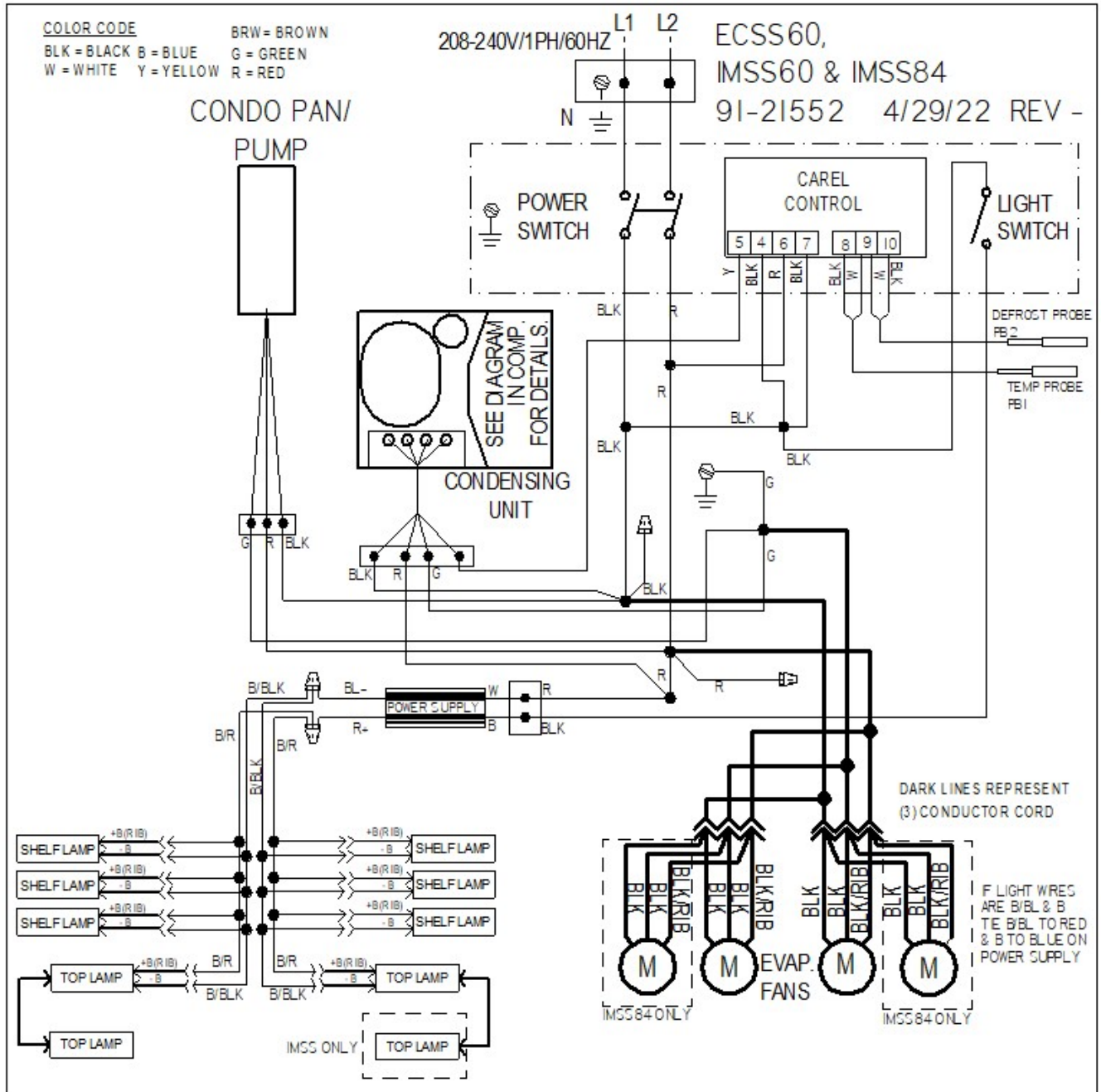

# Self-Contained IMSS84SC

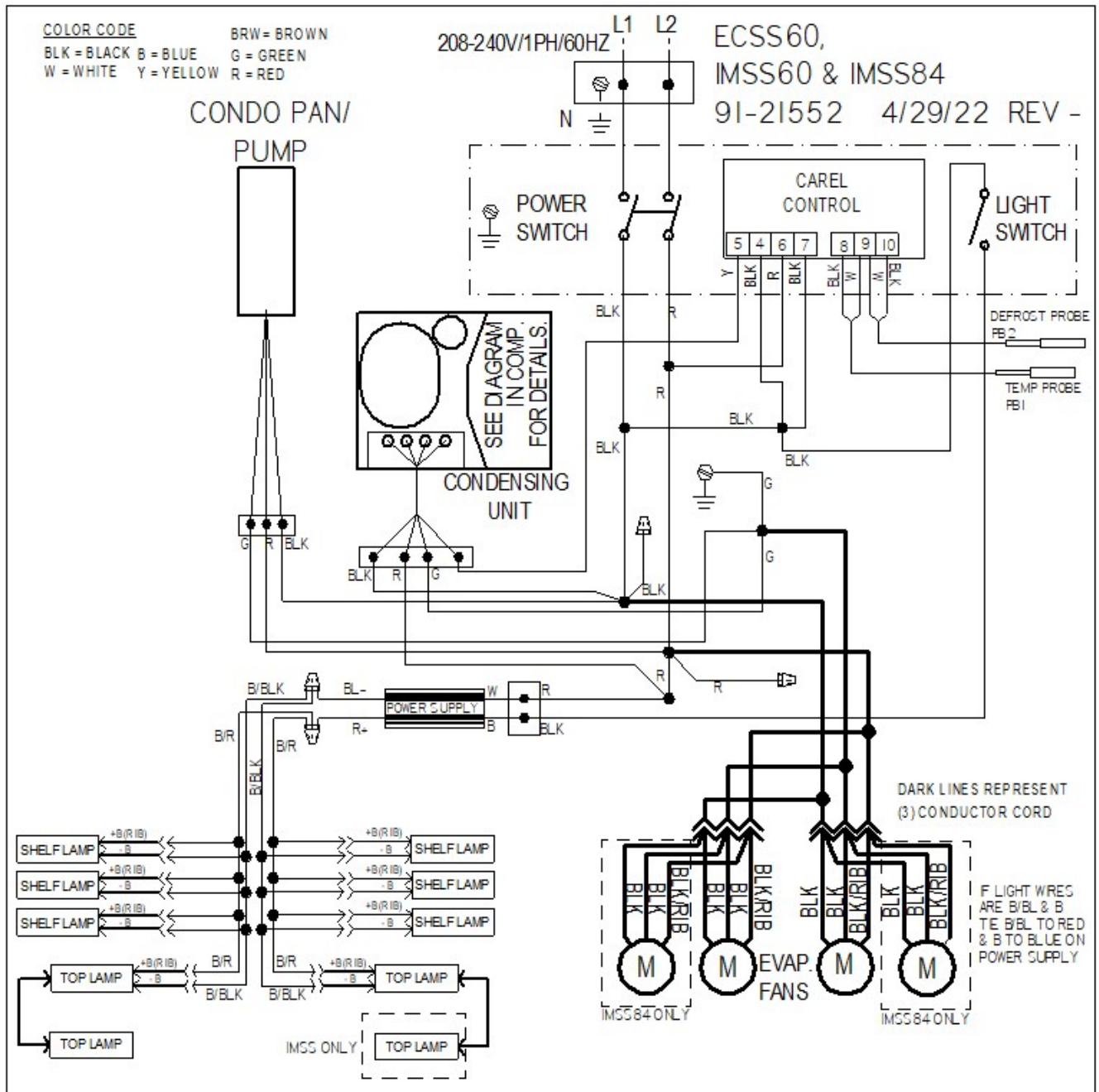

# Self-Contained IMSS120SC

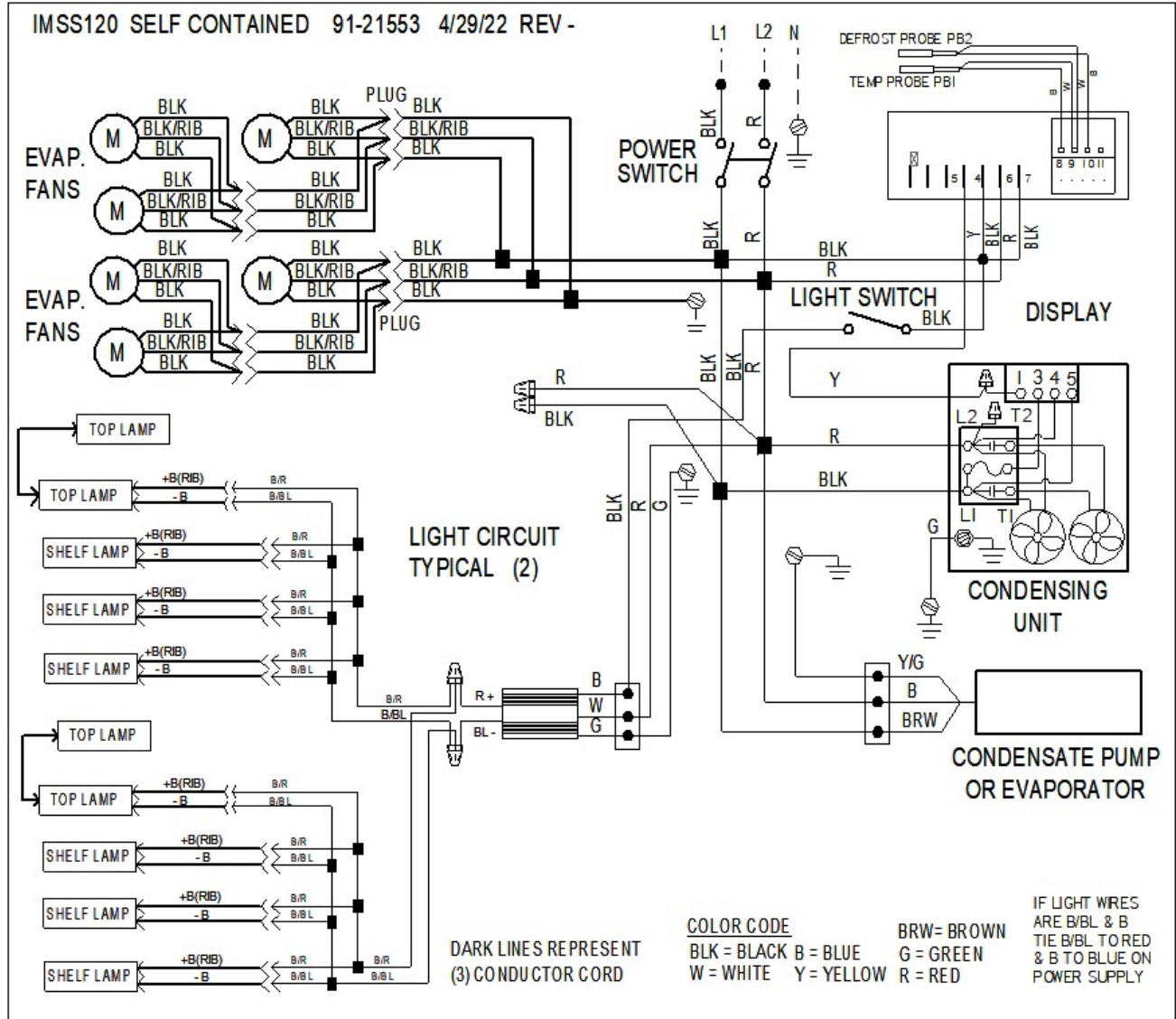

# Remote IMSS60R

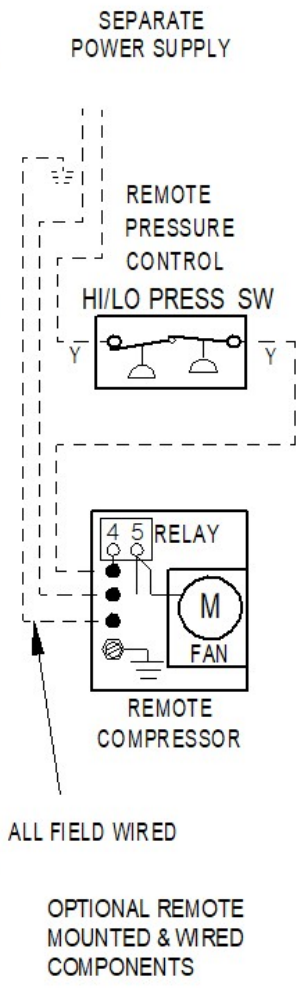
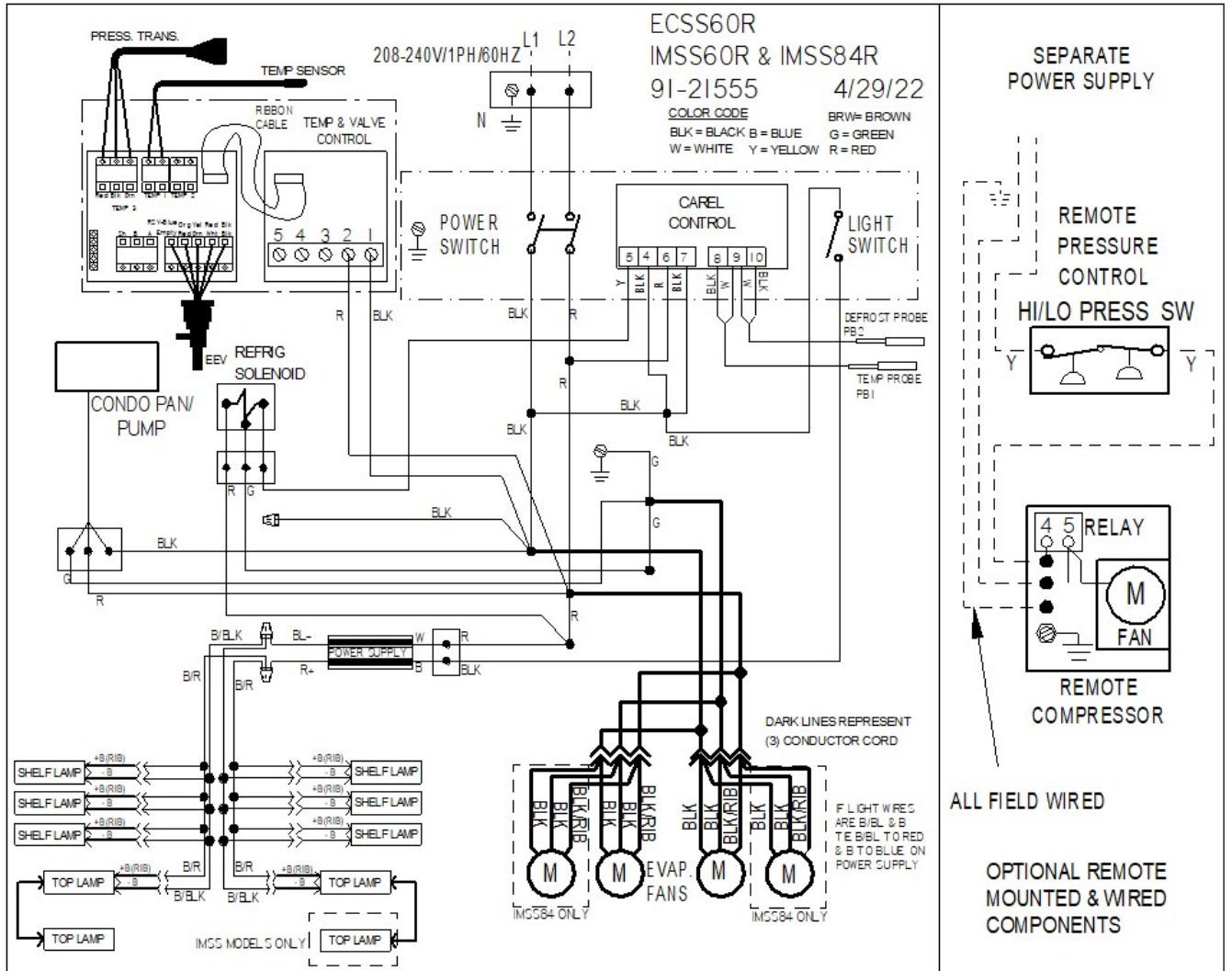

# Remote IMSS84R

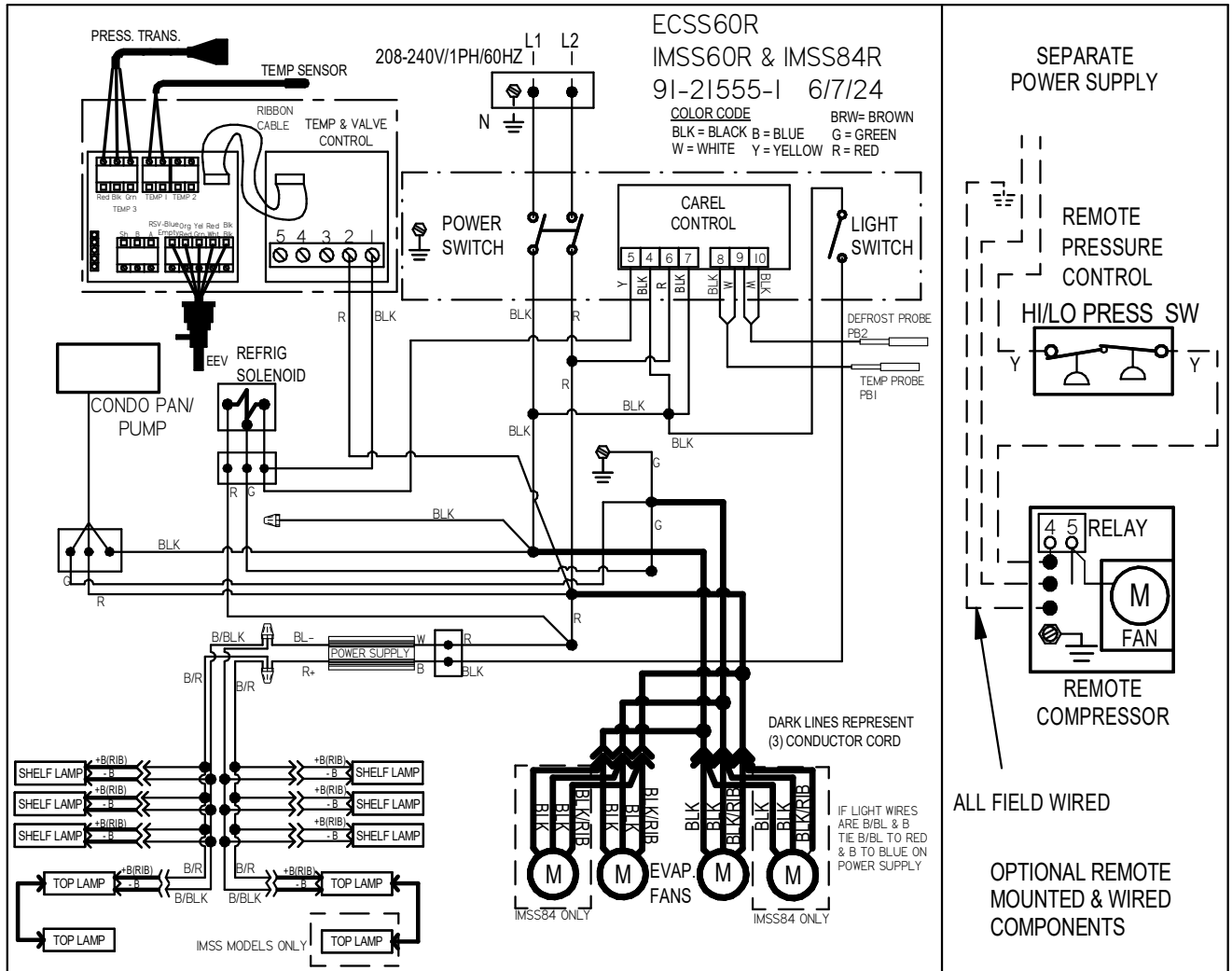

# Remote IMSS120R

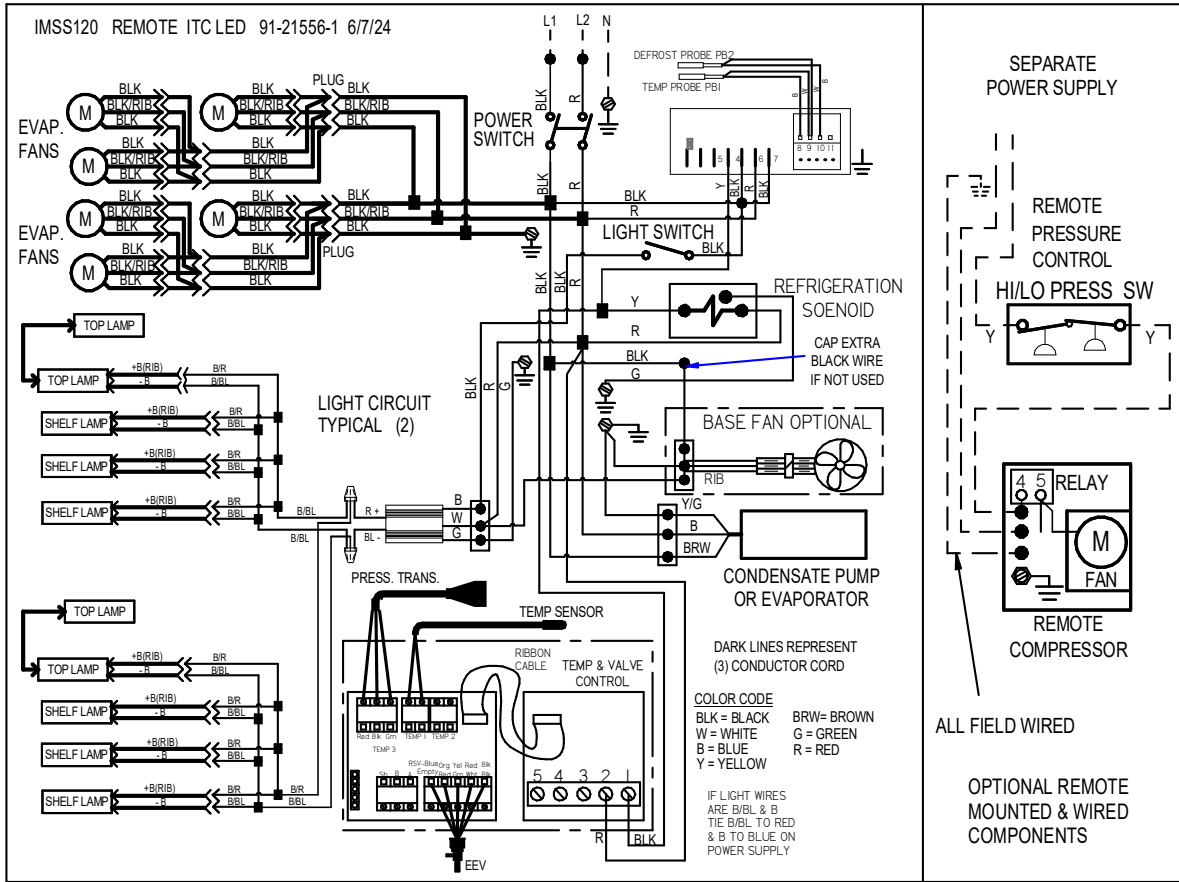

**California Residents Only.**

**⚠ WARNING**

**This product can expose you to chemicals including chromium which is known to the State of California to cause cancer and birth defects or other reproductive harm. For more information go to [www.P65Warnings.ca.gov](http://www.P65Warnings.ca.gov)**

