

Viking Use & Care Manual

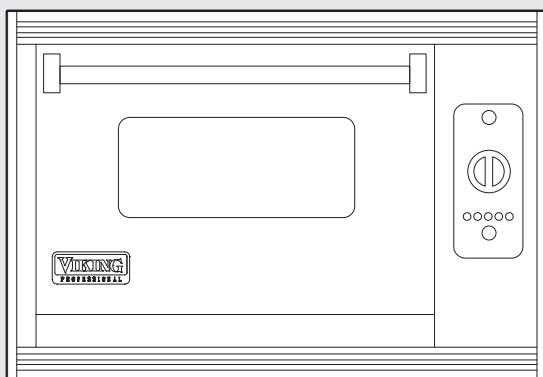

Professional Built-In Gas
Thermal-Convection 36" W. Oven

Congratulations

The purchase of this product attests to the importance you place upon the quality and performance of the major appliances you use. With minimal care, as outlined in this guide, this product is designed to provide you with years of dependable service. Please take the few minutes necessary to learn the proper and efficient use and care of this quality product.

Some of the key features of this appliance include:

- Five performance modes—including convection baking and convection broiling—providing air circulation for shorter cooking times with even results.
- Convection baking with a dual 15,000 BTU burners provides a fast, even baking for all your casserole dishes as well as easy cleanup.
- The 1500°F closed door, infrared broiler allows intense heat to sear delicate to thick cuts of meat providing that restaurant taste.

Your complete satisfaction is our ultimate goal. If you have any questions or comments about this product, please contact the dealer from whom you purchased it, or contact our Consumer Support Center at 1-888-VIKING1 (845-4641).

We appreciate your choice of a Viking oven and hope that you will again select our products for your other major appliance needs.

For more information about the complete and growing selection of Viking products, contact your dealer or visit us online at vikingrange.com.

Table of Contents

Getting Started

Warnings and Important Safety Information _____	4
Before Using Oven _____	11

Product Controls

Setting the Clock _____	12
Oven Features _____	13
Oven Control Panel _____	14
Oven Functions and Settings _____	15
Clocks & Timers _____	16

Operation

Using Your Oven _____	19
Rack Positions _____	19
Conventional and Convection Cooking _____	20
Baking _____	22
Bake (Natural Airflow Baking) _____	22
Convection Bake _____	22
Broiling _____	27
Broil (Infrared Broil) _____	27
Convection Broil (Infrared Convection Broil) _____	27
Convection Dehydrate _____	31
Convection Defrost _____	32

Product Care

Cleaning and Maintenance _____	33
Replacing Oven Lights _____	35
Troubleshooting _____	36
Service Information _____	37
Warranty _____	38

IMPORTANT—Please Read and Follow

Warning and Important Safety Instructions appearing in this manual are not meant to cover all possible conditions and situations that may occur. Common sense, caution, and care must be exercised when installing, maintaining, or operating the appliance.

ALWAYS contact the manufacturer about problems or conditions you do not understand.

Recognize Safety Symbols, Words, Labels

DANGER

Hazards or unsafe practices which WILL result in severe personal injury or death

WARNING

Hazards or unsafe practices which COULD result in death or severe personal injury

CAUTION

Hazards or unsafe practices which COULD result in minor personal injury.

All safety messages will identify the hazard, tell you how to reduce the chance of injury, and tell you what can happen if the instructions are not followed.

Read and follow all instructions before using this appliance to prevent the potential risk of fire, electric shock, personal injury or damage to the appliance as a result of improper usage of the appliance. Use appliance only for its intended purpose as described in this manual.

To ensure proper and safe operation: Appliance must be properly installed and grounded by a qualified technician. **DO NOT** attempt to adjust, repair, service, or replace any part of your appliance unless it is specifically recommended in this manual. All other servicing should be referred to a qualified servicer. Have the installer show you the location of the gas shutoff valve and how to shut it off in an emergency. A certified technician is required for any adjustments or conversions to Natural or LP gas.

IMPORTANT—Please Read and Follow

WARNING

If the information in this manual is not followed exactly, a fire or explosion may result causing property damage, personal injury or death.

DO NOT store or use gasoline or other flammable vapors and liquids in the vicinity of this or any appliance.

WHAT TO DO IF YOU SMELL GAS:

- **DO NOT** try to light any appliance.
- **DO NOT** touch any electrical switch.
- **DO NOT** use any phone in your building.
- Immediately call your gas supplier from a neighbor's phone. Follow the gas supplier's instructions.
- If you cannot reach your gas supplier, call the fire department.

Installation and service must be performed by a qualified installer, service agency or the gas supplier.

WARNING

DO NOT use commercial oven cleaners inside the oven. Use of these cleaners can produce hazardous fumes or can damage the porcelain finishes.

WARNING

NEVER cover any slots, holes or passages in the oven bottom or cover an entire rack with materials such as aluminum foil. Doing so blocks air flow through the oven and may cause carbon monoxide poisoning. Aluminum foil linings may also trap heat, causing a fire hazard.

WARNING



To avoid risk of property damage, personal injury or death; follow information in this manual exactly to prevent a fire or explosion.

IMPORTANT—Please Read and Follow

To Prevent Fire or Smoke Damage

- Be sure all packing materials are removed from the appliance before operating it.
- Keep area around appliance clear and free from combustible materials, gasoline, and other flammable vapors and materials.
- Many aerosol-type spray cans are **EXPLOSIVE** when exposed to heat and may be highly flammable. Avoid their use or storage near an appliance.
- Many plastics are vulnerable to heat. Keep plastics away from parts of the appliance that may become warm or hot.
- Combustible items (paper, plastic, etc.) may ignite and metallic items may become hot and cause burns. **DO NOT** pour spirits over hot foods. **DO NOT** leave oven unsupervised when drying herbs, breads, mushrooms, etc; fire hazard.

In Case of Fire

Turn off appliance and ventilating hood to avoid spreading the flame. Extinguish flame then turn on hood to remove smoke and odor.

- Smother fire or flame by closing the oven door.
DO NOT use water on grease fires. Use baking soda, a dry chemical or foam-type extinguisher to smother fire or flame.
- **GREASE**—Grease is flammable and should be handled carefully. Let fat cool before attempting to handle it. **DO NOT** allow grease to collect around the oven or in vents. Wipe up spillovers immediately.

Child Safety

- If storage is provided, it should be limited to items which are used infrequently and which are safely stored in an area subjected to heat from an appliance. Temperatures may be unsafe for some items, such as volatile liquids, cleaners or aerosol sprays.
- **NEVER** leave children alone or unsupervised near the appliance when it is in use or is still hot.
- **NEVER** allow children to sit or stand on any part of the appliance as they could be injured or burned.
- **DO NOT** store items of interest to children over the unit. Children climbing to reach items could be seriously injured.
- Children should be taught that an appliance is not a toy. Children should not be allowed to play with controls or other parts of the appliance.

IMPORTANT—Please Read and Follow

Cooking Safety

- Use dry, sturdy pot-holders. Damp pot-holders may cause burns from steam. Dishtowels or other substitutes should **NEVER** be used as potholders because they can get caught on appliance parts.
- **ALWAYS** let quantities of hot fat used for deep fat frying cool before attempting to move or handle.
- Loose-fitting or hanging garments should never be worn while using the appliance. **DO NOT** drape towels or materials on oven door handles. These items could ignite and cause burns.
- **ALWAYS** place oven racks in the desired positions while oven is cool. Slide oven rack out to add or remove food, using dry, sturdy pot-holders. **ALWAYS** avoid reaching into the oven to add or remove food. If a rack must be moved while hot, use a dry pot-holder.
- **ALWAYS** turn the oven off at the end of cooking.
- **DO NOT** heat unopened food containers; buildup of pressure may cause the container to explode and result in injury.
- Use care when opening the oven door. Let hot air or steam escape before moving or replacing food.
- **NEVER** use aluminum foil to cover oven racks or oven bottom. This could result in risk of electric shock, fire, or damage to the appliance. Use foil only as directed in this guide.
- **PREPARED FOOD WARNING:** Follow food manufacturer's instructions. If a plastic frozen food container and/or its cover distorts, warps, or is otherwise damaged during cooking, immediately discard the food and its container. The food could be contaminated.
- Once the unit has been installed as outlined in the Installation Instructions, it is important that the fresh air supply is not obstructed. The use of a gas cooking appliance results in the production of heat and moisture in the room in which it is installed. Ensure that the kitchen is well-ventilated. Keep natural venting holes open or install a mechanical ventilation device. Prolonged or intensive use of the appliance may call for additional (such as opening a window) or more effective ventilation (such as increasing the level of a mechanical ventilation if present).

Burners

- **NEVER** touch oven burners, areas near broiler and bake burner, or interior surfaces of oven.
- Burners may be hot even though they are dark in color. Areas near burners and interior surfaces of an oven may become hot enough to cause burns.

IMPORTANT—Please Read and Follow

Burners (cont.)

- **DO NOT TOUCH INTERIOR SURFACES OF OVEN.**

Interior surfaces of an oven become hot enough to cause burns. During and after use, **DO NOT** touch or let clothing or other flammable materials contact interior surfaces of oven until they have had sufficient time to cool. Other surfaces of the oven may become hot enough to cause burns, such as the oven vent opening, the surface near the vent opening, and the oven door window.

Cleaning Safety

- Turn off all controls and wait for appliance parts to cool before touching or cleaning them.
- Clean appliance with caution. Use care to avoid steam burns if a wet sponge or cloth is used to wipe spills on a hot surface. Some cleaners can produce noxious fumes if applied to a hot surface.
- **DO NOT** clean door gasket. It is essential for a good tight seal. Care should be taken not to rub, damage, or move the gasket.
- No commercial oven cleaner or oven liner protective coating such as aluminum foil should be used in or around any part of the oven. Improper oven liners may result in a risk of electric shock or fire. Keep oven free from grease buildup.

About Your Appliance

CAUTION

NEVER use appliance as a space heater to heat or warm a room to prevent potential hazard to the user and damage to the appliance. Also, **DO NOT** use the oven as a storage area for food or cooking utensils.

- Avoid touching oven vent area while oven is on and for several minutes after oven is turned off. When the oven is in use, the vent and surrounding area become hot enough to cause burns. After oven is turned off, **DO NOT** touch the oven vent or surrounding areas until they have had sufficient time to cool.
- The misuse of oven doors (e.g. stepping, sitting, or leaning on them) can result in potential hazards and/or injuries.
- The appliance must be installed and electrically grounded according to local codes. Have the installer identify the location and shut-off valve on the oven so you know where and how to turn off gas if necessary.

KEEP THESE INSTRUCTIONS FOR FUTURE REFERENCE.

IMPORTANT—Please Read and Follow

⚠ WARNING



ELECTRICAL SHOCK HAZARD

DO NOT touch a hot oven light bulb with a damp cloth as the bulb could break. Should the bulb break, disconnect power to the appliance before removing bulb to avoid electrical shock.

⚠ WARNING



ELECTRICAL SHOCK HAZARD

Disconnect the electric power at the main fuse or circuit breaker before replacing bulb.

⚠ WARNING



BURN OR ELECTRICAL SHOCK HAZARD

Make sure all controls are OFF and oven is COOL before cleaning. Failure to do so can result in burns or electrical shock.

⚠ WARNING

To avoid sickness and food waste when using automatic time baking:

- **DO NOT** use foods that will spoil while waiting for cooking to start, such as dishes with milk or eggs, cream soups, custards, fish, pork, poultry, or foods with stuffing.
- Any food that has to wait for cooking to start should be very cold or frozen before it is placed in the oven.
- **DO NOT** use foods containing baking powder or yeast when automatic time baking. They will not rise properly.
- **DO NOT** allow food to remain in the oven for more than two hours after the end of the cooking cycle.
- To avoid sickness and food waste, **DO NOT** allow defrosted food to remain in the oven for more than two hours.

IMPORTANT—Please Read and Follow

CAUTION

You must carefully check the food during the dehydration process to ensure that it does not catch fire.

NOTICE

DO NOT turn the Temperature Control on during defrosting. Turning the convection fan on will accelerate the natural defrosting of the food without the heat.

CAUTION

BURN HAZARD

The oven door, especially the glass, can get hot. **Danger of burning: DO NOT touch the glass!**

CAUTION

DO NOT store items of interest to children over the unit. Children climbing to reach items could be seriously injured.

Before Using Oven

All products are wiped clean with solvents at the factory to remove any visible signs of dirt, oil, and grease which may have remained from the manufacturing process. There may be some burn off and odors on first use of the appliance—this is normal.

Oven

Important! Before first use, wipe interior with soapy water and dry thoroughly. Then set the oven selector to bake, the thermostat to 350°F, and operate for an hour.

- Five performance modes—including convection baking and convection broiling—providing air circulation for shorter cooking times with even results.
- Convection baking with dual 15,000 BTU burners provides a fast, even baking for all your casserole dishes as well as easy cleanup.
- The 1500°F closed door, infrared broiler allows intense heat to sear delicate cuts of meat providing that restaurant taste.
- Lighted digital display indicates time and temperature.
- Porcelain removable bottom and sides for easier cleaning.
- This appliance is certified by Star-K to meet strict regulations in conjunction with specific instructions found on www.star-k.org.

Setting the Clock

Digital Display

The time-of-day must be set before any other program can be used. When your oven is first connected to the power in your home, the timer display will show 12:00.

To program the time-of-day:

1. Press the "CLOCK" button.
A single tone will sound and the colon will flash indicating the clock function has been accessed.
2. "UP" and "DOWN" are used to set the time of day. "UP" increases time; "DOWN" decreases time. "UP/DOWN" will increase or decrease the time in 1-minute increments. When the button is held down, time will increase or decrease in 5-minute increments until the next hour is reached, then will continue to increase or decrease in hour increments.
3. Release the button when the appropriate time has been reached.
4. The clock mode will terminate if the time is not set within 30 seconds of accessing the clock function. The colon will cease flashing indicating the clock mode has been terminated. Pressing "CANCEL" once will also terminate the clock mode.

The time-of-day can be changed by following steps 1 through 4. It cannot be changed while there is a TIMER or COOK TIME cycle programmed into the timer.

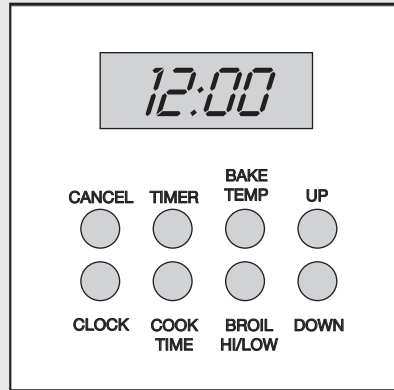

Oven Features

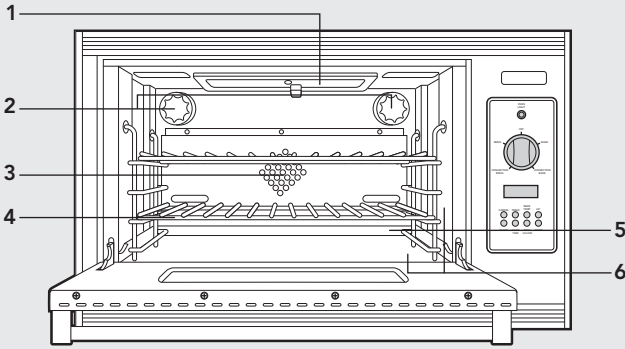

- 1. Gourmet Glo™ Infrared burner
- 2. Oven lights (2)
- 3. Convection fan
- 4. Oven racks (3)
- 5. Bake burner
- 6. Removable bottom and sides

Oven Control Panel

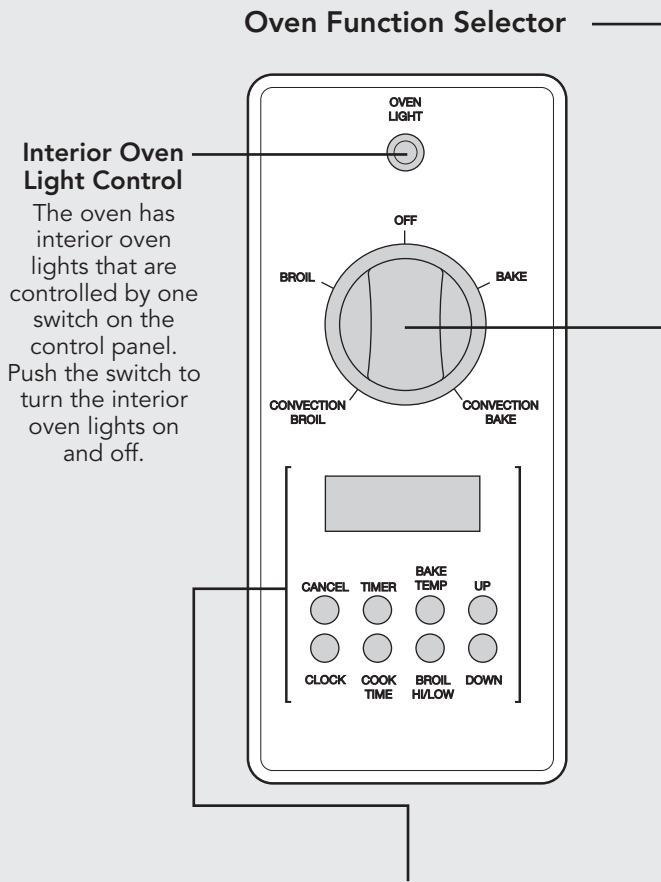

Interior Oven Light Control
The oven has interior oven lights that are controlled by one switch on the control panel. Push the switch to turn the interior oven lights on and off.

Electronic Timing/Temperature Center

The Electronic Timing/Temperature Center is used to program and control all timing and temperature functions. Each oven has a separate temperature control and a separate oven function selector. The button control can be set at any temperature from 170° F (76.6° C) to 550° F (287.8° C) by pressing "UP" or "DOWN". There are separate settings for broiling and HI/LO BROIL. **ALWAYS** be sure the controls are in the OFF position when the oven is not in use.

IMPORTANT—The time-of-day must be set before any other program can be used.

Oven Functions and Settings

BAKE (Natural Airflow Bake)

Use this setting for baking, roasting, and preparing casseroles dishes.

CONVECTION BAKE

Use this setting to bake and roast foods at the same time with minimal taste transfer.

BROIL (Infrared Broil)

Use this setting for broiling dark meats at 1" thickness or less where rare or medium doneness is desired.

CONVECTION BROIL (Infrared Convection Broil)

Use this setting to broil thick cuts of meat.

Convection Dehydrate (CONVECTION BAKE)

Use this function to dehydrate fruits and vegetables.

Convection Defrost (CONVECTION BAKE)

Use this function to defrost foods.

Note: For more information on oven functions see "Operation" section.

Clocks and Timers

Electronic Timing/ Temperature Center (Digital Display)

The Electronic Timing/
Temperature Center controls
are used to program timing
and temperature functions. It
has eight display buttons and
five programming modes. Both
the Cook Time mode and
Timer mode can be used to
time cooking periods.

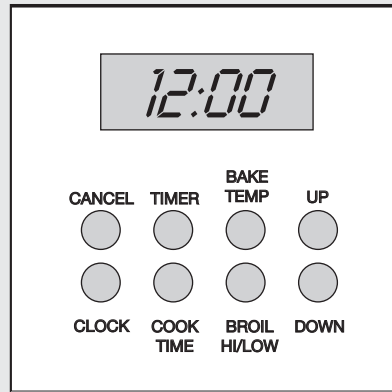

Setting the Min/Hour Timer

The Min/Hour timer is designed for accurate timing of foods. It is ideal for baking delicate items such as biscuits, cookies, and popovers, and for precise broiling.

To Program the Min/Hour Timer

1. Press the "TIMER" button. The timer will display :00.
2. Press the "UP" or "DOWN" buttons to increase or decrease time. The time will change in 1-minute increments. When the button is held down, time will change in 5-minute increments until the next hour is reached.

Note: The TIMER mode will lockout changes and begin to count down if buttons are not pressed for 5 seconds. Pressing "TIMER" once will allow the timer set time to be changed during the countdown process. The timer can be set from a minimum time of 1-minute to a maximum of 11 hours 59 minutes. When the timer counts down to 1-minute a single tone will sound indicating the timer will time out in 1-minute. When the timer counts down to 0:00, three tones will sound every 12 seconds until the timer is canceled by pressing the "TIMER" for three seconds or until ten minutes has elapsed.

Note: To cancel the timer, press and hold the "TIMER" button for three seconds.

Clocks and Timers

Setting Cook Time Program

COOK TIME automatically ends a cooking function. This feature does not automatically start a cooking function. This program is used for controlled timing of baked or roasted foods.

1. Press the "COOK TIME" button once to access the timed cook mode. A single tone will sound and 0:00 will appear on the display.
2. The "UP" and "DOWN" buttons are used to set the timer. "UP" increases time; "DOWN" decreases time. Tapping "UP" and "DOWN" will increase or decrease the time in 1-minute increments. When the "UP" or "DOWN" is held down, time will increase or decrease in 5-minute increments until the next hour is reached, then will continue to increase or decrease in hour increments.
3. Release the button when the appropriate time has been reached.

Note: When COOK TIME is set before the bake temperature, the bake indicator light in the upper left corner and the -- of the display will light after 5 seconds prompting the setting of the bake temperature using the "UP" or "DOWN" buttons. The temperature will default to 350°F when either button is pressed. Tapping the "UP" or "DOWN" button will increase or decrease the temperature in 5° increments. The temperature will increase or decrease in 25° increments when the "UP" or "DOWN" button is pressed and held down. The temperature can be set from a low of 170°F to a high of 550°F. The oven set temperature and bake indicator light will be displayed during the baking process. The BAKE function may be terminated by pressing "CANCEL" once. Cook time will be terminated and the time of day displayed if the temperature is not set within 30 seconds. When the COOK TIME reaches 0:00 three tones will sound every 12 seconds until the timer is canceled by pressing the "TIMER" button for three seconds, pressing the "CANCEL" button, or until ten minutes has elapsed.

Clocks and Timers

To Set The Bake Temperature

1. Press "BAKE TEMP" once. A single tone will sound, the bake indicator light in the upper left corner and the bar segments "----" of the display will light prompting the setting of the bake temperature using the "UP" or "DOWN" buttons.
2. The temperature will default to 350°F when either "UP" or "DOWN" button is pressed. Tapping the "UP" or "DOWN" buttons will increase or decrease the temperature in 5-degree increments. The temperature will increase or decrease in 25° increments when the "UP" or "DOWN" buttons are pressed and held down. The temperature can be set from a low of 170°F to a high of 550°F. When the desired temperature has been reached, a tone will sound indicating the oven has preheated.
3. **Set the Oven Function selector** to the desired function – BAKE, CONVECTION BAKE, BROIL or CONVECTION BROIL.
4. BAKE TEMP setting may be terminated by pressing the "CANCEL" button.

Using the Oven

Rack Positions

The convection oven is equipped with three tilt-proof racks and four rack positions. Position 4 is the farthest from the oven bottom. Position 1 is the closest to the oven bottom. The racks can be easily removed and arranged at various levels. For best results with conventional baking, do not use more than one rack at a time. It is recommended when using two racks to do the following:

1. Arrange the oven racks in the desired position BEFORE heating the oven. If cooking on two racks at the same time, use rack positions 2 and 4.
2. Turn the function selector to the desired function.
3. Set the temperature control to the desired temperature.
4. Place the food in the oven after preheating. Preheating is complete when the tone sounds.

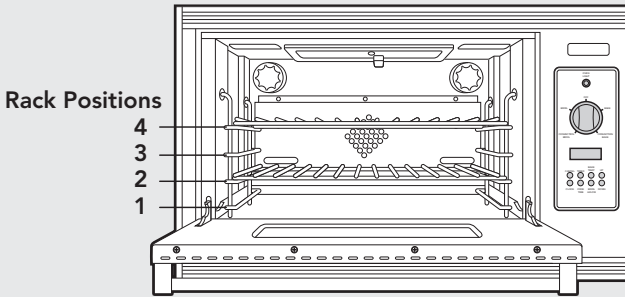

Using the Oven

Conventional and Convection Cooking

Because of variations in food density, surface texture and consistency, some foods may be prepared more successfully using the conventional bake setting. For this reason, conventional baking is recommended when preparing baked goods such as custard. The user may find other foods that are also prepared more consistently in conventional bake. It is recommended to use this function for single-rack baking.

Convection Cooking Tips

Convection cooking is a cooking technique which utilizes fan-forced air to circulate throughout the entire oven cavity creating the optimum cooking environment. Cooking with convection is intended when performing multi-rack baking and for heavier foods. Below are some tips which will allow you to get the best results out of your oven when cooking with convection.

- As a general rule, to convert conventional recipes to convection recipes, reduce the temperature by 25° F (10° C) when using a convection cooking function.
- Cooking times for standard baking and convection baking will be the same. However, if using convection to cook a single item or smaller load, then it is possible to have 10-15% reduction in cooking time. (Remember convection cooking is designed for multi-rack baking or cooking large loads.)
- If cooking items which require longer than 45 minutes, then it is possible to see a 10-15% reduction in cooking time.
- A major benefit of convection cooking is the ability to prepare foods in quantity. The uniform air circulation makes this possible. Foods that can be prepared on two of three racks at the same time include: pizza, cakes, cookies, biscuits, muffins, rolls, and frozen convenience foods.

Using the Oven

Convection Cooking Tips (cont.)

- For three-rack baking, use any combination of rack positions 2, 3, and 4. For two-rack baking, use rack positions 2 and 4. Remember that the racks are numbered from bottom to top.
- Items cooked in a convection function can be easily over baked. This being the case, it is usually a good idea to pull items out of the oven just before they seem to be done. Items will continue to cook right after they are set out of the oven.
- Some recipes, especially those that are homemade, may require adjustment and testing when converting from standard to convection modes. If unsure how to convert a recipe, begin by preparing the recipe in conventional bake. After achieving acceptable results, follow the convection guidelines listed for the similar food type. If the food is not prepared to your satisfaction during this first convection trial, adjust only one recipe variable at a time (cooking time, rack position, or temperature) and repeat the convection test. Continue adjusting one recipe variable at a time until satisfactory results are achieved.

Baking

BAKE (Natural Airflow Bake)

Full power heat is radiated from the two bake burners in the bottom of the oven cavity and is circulated with natural airflow. This function is recommended for single rack bakings. Many cookbooks contain recipes to be cooked in the conventional manner. Conventional baking is suitable for dishes that require a high temperature. Use this setting for baking and casseroles.

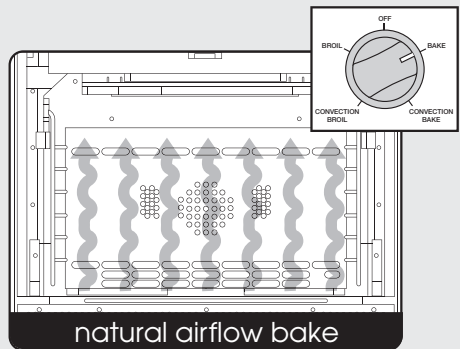

CONVECTION BAKE

Heat is radiated from the bake burners in the bottom of the oven cavity. The heated air is circulated by the motorized fan in the rear of the oven providing more even heat distribution. This even circulation of air equalizes the temperature throughout the oven cavity and eliminates the hot and cold spots found in convection ovens.

Multiple rack use is possible for the largest baking job. When roasting, cool air is quickly replaced—searing meats on the outside and retaining more juices and natural flavor on the inside with less shrinkage. This even circulation of air equalizes the temperature throughout the oven cavity and eliminates the hot and cold spots found in conventional ovens.

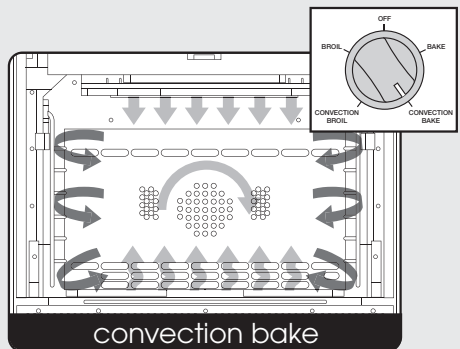

Baking Tips

- Make sure the oven racks are in the desired position before you turn on the oven.
- **DO NOT** open the door frequently during baking. Look through the door window to check doneness whenever possible. If you must open the door, the best time is during the last quarter of the baking time.
- Bake to the shortest time suggested and check for doneness before adding more time. For baked goods, a stainless steel knife placed in the center of the product should come out clean when done.
- Use the pan size and type recommended by the recipe to ensure best results. Cakes, quick breads, muffins, and cookies should be baked in shiny, reflective pans for light, golden crusts. Avoid the use of old, darkened pans. Warped, dented, stainless steel and tin-coated pans heat unevenly and will not give uniform baking results.

Baking

Pan Placement Tips

- When using large (15" x 13") flat pans or trays that cover most of the rack, rack positions 2 or 3 produce the best results.
- When baking on more than one rack, it is recommended to use the 2nd and 4th position for more consistent even baking.
- Stagger pans in opposite directions when two racks and several pans are used in conventional bake. If possible, no pan should be directly above another.
- Allow 1 to 2 inches of air space around all sides of each pan for even air circulation.

Single Rack Pan Placement

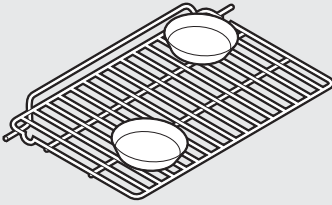

Multiple Rack Pan Placement

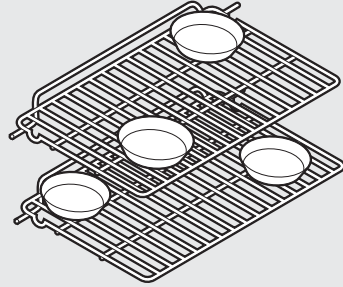

Baking

Conventional Baking Chart

Food	Pan Size	Single Rack Position	Temp	Time (min)
BREADS				
Biscuits	Cookie sheet	2 or 3	400° F (204° C)	10 - 12
Yeast loaf	Loaf pan	2 or 3	375° F (191° C)	30 - 35
Yeast rolls	Cookie sheet	2 or 3	400° F (204° C)	12 - 15
Nut bread	Loaf pan	2 or 3	375° F (191° C)	30 - 35
Cornbread	8" x 8"	2 or 3	400° F (204° C)	25 - 30
Gingerbread	8" x 8"	2 or 3	350° F (177° C)	35 - 40
Muffins	Muffin tin	2 or 3	375° F (191° C)	15 - 20
Corn muffins	Muffin tin	2 or 3	375° F (191° C)	15 - 20
CAKES				
Angel food	Tube pan	2 or 3	375° F (191° C)	35 - 45
Bundt	Tube pan	2 or 3	350° F (177° C)	45 - 55
Cupcakes	Muffin pan	2 or 3	350° F (177° C)	16 - 20
Layer, sheet	13" x 9"	2 or 3	350° F (177° C)	40 - 50
Layer, two	9" round	2 or 3	350° F (177° C)	30 - 35
Pound	Loaf pan	2 or 3	350° F (177° C)	60 - 65
COOKIES				
Brownies	13" x 9"	2 or 3	350° F (177° C)	25 - 30
Choc. chip	Cookie sheet	2 or 3	375° F (191° C)	12 - 15
Sugar	Cookie sheet	2 or 3	375° F (191° C)	10 - 12
PASTRY				
Cream puffs	Cookie sheet	2 or 3	400° F (204° C)	30 - 35
PIES				
Crust, unfilled	9" round	2 or 3	400° F (204° C)	10 - 12
Crust, filled	9" round	2 or 3	350° F (191° C)	55 - 60
Lemon meringue	9" round	2 or 3	350° F (177° C)	12 - 15
Pumpkin	9" round	2 or 3	350° F (177° C)	35 - 40
Custard	6 - 4 oz cups	2 or 3	350° F (177° C)	35 - 40
ENTREES				
Egg rolls	Cookie sheet	2 or 3	400° F (204° C)	25 - 30
Fish sticks	Cookie sheet	2 or 3	425° F (218° C)	10 - 15
Lasagna, frz	Cookie sheet	2 or 3	375° F (191° C)	55 - 60
Pot pie	Cookie sheet	2 or 3	400° F (204° C)	35 - 40
Gr. peppers stuffed	13" x 9"	2 or 3	375° F (191° C)	60 - 70
Quiche	9" round	2 or 3	400° F (204° C)	25 - 30
Pizza, 12"	Cookie sheet	2 or 3	400° F (204° C)	15 - 20
Mac. & cheese, frz	Cookie sheet	2 or 3	375° F (191° C)	35 - 40
VEGETABLES				
Baked potatoes	On rack	2 or 3	375° F (191° C)	60 - 65
Spinach souffle	1 qt. casserole	2 or 3	350° F (177° C)	45 - 50
Squash	Cookie sheet	2 or 3	375° F (191° C)	50 - 55
French fries	Cookie sheet	2 or 3	425° F (218° C)	20 - 25

***Note:** The above information is given as a guide only.

Baking

Convection Baking Chart

Food	Pan Size	Single Rack Position	Temp	Time (min)
BREADS				
Biscuits	Cookie sheet	2 or 3	375° F (191° C)	7 - 9
Yeast loaf	Loaf pan	2 or 3	375° F (191° C)	25 - 30
Yeast rolls	Cookie sheet	2 or 3	375° F (191° C)	11 - 13
Nut bread	Loaf pan	2 or 3	350° F (177° C)	25 - 30
Cornbread	8" x 8"	2 or 3	375° F (191° C)	20 - 25
Gingerbread	8" x 8"	2 or 3	325° F (163° C)	30 - 35
Muffins	Muffin tin	2 or 3	350° F (177° C)	12 - 15
Corn muffins	Muffin tin	2 or 3	350° F (177° C)	10 - 12
CAKES				
Angel food	Tube pan	2 or 3	350° F (177° C)	35 - 40
Bundt	Tube pan	2 or 3	325° F (163° C)	35 - 40
Cupcakes	Muffin pan	2 or 3	325° F (163° C)	15 - 17
Layer, sheet	13" x 9"	2 or 3	325° F (163° C)	30 - 35
Layer, two	9" round	2 or 3	325° F (163° C)	25 - 30
Pound	Loaf pan	2 or 3	325° F (163° C)	45 - 50
COOKIES				
Brownies	13" x 9"	2 or 3	325° F (163° C)	20 - 25
Choc. chip	Cookie sheet	2 or 3	350° F (177° C)	7 - 10
Sugar	Cookie sheet	2 or 3	350° F (177° C)	7 - 10
PIES				
Crust, unfilled	9" round	2 or 3	375° F (191° C)	7 - 9
Crust, filled	9" round	2 or 3	325° F (163° C)	50 - 55
Lemon meringue	9" round	2 or 3	325° F (163° C)	10 - 12
Pumpkin	9" round	2 or 3	325° F (163° C)	45 - 55
Custard	Not recommended			
ENTREES				
Egg rolls	Cookie sheet	2 or 3	375° F (191° C)	15 - 20
Fish sticks	Cookie sheet	2 or 3	400° F (205° C)	8 - 10
Lasagna, frz	Cookie sheet	2 or 3	350° F (177° C)	45 - 50
Pot pie	Cookie sheet	2 or 3	375° F (191° C)	35 - 40
Gr. peppers stuffed	13" x 9"	2 or 3	350° F (177° C)	45 - 50
Quiche	Not recommended			
Pizza, 12"	Cookie sheet	2 or 3	375° F (191° C)	15 - 20
Mac. & cheese, frz	Cookie sheet	2 or 3	350° F (177° C)	25 - 35
VEGETABLES				
Baked potatoes	On rack	2 or 3	350° F (177° C)	50 - 55
Spinach souffle	1 qt. casserole	2 or 3	325° F (163° C)	35 - 40
Squash	Cookie sheet	2 or 3	350° F (177° C)	40 - 45
French fries	Cookie sheet	2 or 3	400° F (205° C)	15 - 20

***Note:** The above information is given as a guide only.

Baking

Solving Baking Problems

Baking problems can occur for many reasons. Check the chart below for the causes and remedies for the most common problems. It is important to remember that the temperature setting and cooking times you are accustomed to using with your previous oven may vary slightly from those required with this oven. If you find this to be true, it is necessary for you to adjust your recipes and cooking times accordingly.

Common Baking Problems/Remedies

Problems	Cause	Remedy
Cakes burned on the sides or not done in center	1. Oven was too hot 2. Wrong pan size 3. Too many pans	1. Reduce temperature 2. Use recom. pan size 3. Reduce no. of pans
Cakes crack on top	1. Batter too thick 2. Oven too hot 3. Wrong pan size	1. Follow recipe Add liquid 2. Reduce temperature 3. Use recom. pan size
Cakes are not level	1. Batter uneven 2. Oven or rack not level 3. Pan was warped	1. Distribute batter even 2. Level oven or rack 3. Use proper pan
Food too brown on bottom	1. Oven door opened too often 2. Dark pans being used 3. Incorrect rack position 4. Wrong bake setting 5. Pan too large	1. Use door window to check food 2. Use shiny pans 3. Use recom. rack position 4. Adjust to conventional or convection setting as needed 5. Use proper pan
Food too brown on top	1. Rack position too high 2. Oven not preheated 3. Sides of pan too high	1. Use recom. rack position 2. Allow oven to preheat 3. Use proper pans
Cookies too flat	1. Hot cookie sheet	1. Allow sheet to cool between batches
Pies burned around edges	1. Oven too hot 2. Too many pans used 3. Oven not preheated	1. Reduce temperature 2. Reduce no. of pans 3. Allow oven to preheat
Pies too light on top	1. Oven not hot enough 2. Too many pans used 3. Oven not preheated	1. Increase temperature 2. Reduce no. of pans 3. Allow oven to preheat

Broiling

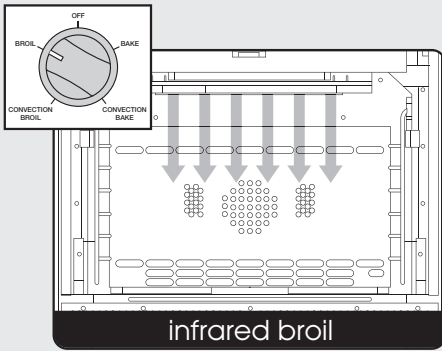

BROIL (Infrared Broil)

Heat radiates from the Gourmet Glo™ infrared broiler located at the top of the oven cavity. The distance between the foods and the broil elements determines broiling speed. For “fast” broiling, food may be as close as 2” (5 cm) to the broil element or on the top rack. “Fast” broiling is best for meats where

rare to medium doneness is desired. Use this setting for broiling small and average cuts of meat.

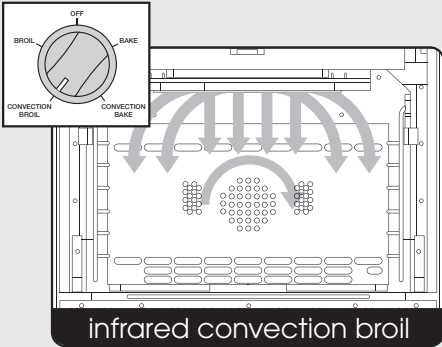

CONVECTION BROIL (Infrared Convection Broil)

Exactly the same as regular broiling with the additional benefit of air circulation by the motorized fan in the rear of the oven. Smoke is reduced since the airflow reduces peak temperatures on the food. Use this setting for thick cuts of meat.

Broiling Instructions

Broiling is a dry-heat cooking method using direct or radiant heat. It is used for small, individualized cuts such as steaks, chops, and patties. Broiling speed is determined by the distance between the food and the broil element. Choose the rack position based on desired results.

Conventional broiling is most successful for cuts of meat 1-2 inches thick and is also more suitable for flat pieces of meat. Convection broiling has the advantage of broiling food slightly quicker than conventional. Convection broiling of meats produces better results, especially for thick cuts.

The meat sears on the outside and retains more juices and natural flavor inside with less shrinkage.

Broiling

To Use Broil

The oven's broiler features a HI and LO broil function. The LO broil function should be used for slow broiling since the unit will cycle on and off frequently. The HI broil function should be used for fast broiling as the unit will cycle less frequently.

1. Arrange the oven rack in the desired position before turning broiler on.
2. Center the food on cold broiler pan and grid supplied with your oven. Place broiler pan in oven.
3. Set the oven function selector to either BROIL or CONVECTION BROIL. Press "BROIL". Press the "UP" button for HI broil or the "DOWN" button for LO broil. HI will appear if the "UP" button is pressed; LO will appear if the "DOWN" button is pressed.
4. Press the "BROIL HI/LO" once. A single tone will sound, the broil indicator light will appear in the lower left corner and "---" will light indicating the broil function has been accessed.
5. Press the "UP" button for HI broil or the "DOWN" button for LO broil.
6. BROIL will terminate if the HI/LO BROIL is not selected within 30 seconds. BROIL can also be terminated by pressing the "CANCEL" button once.

Broiling

Broiling Tips

- **ALWAYS** use a broiler pan and grid for broiling. They are designed to provide drainage of excess liquid and fat away from the cooking surface to help prevent splatter, smoke, and fire.
- To keep meat from curling, slit fatty edge.
- Brush chicken and fish with butter several times as they broil to prevent drying out. To prevent sticking, lightly grease broiler tray.
- Broil on first side for slightly more than half the recommended time, season, and turn. Season second side just before removing.
- **ALWAYS** pull rack out to stop position before turning or removing food.
- Use tongs or a spatula to turn meats. **NEVER** pierce meat with a fork, as this allows the juices to escape.
- Remove the broiler pan from the oven when you remove the food. Drippings will bake onto the pan if it is left in the heated oven after broiling. While pan is hot, place damp paper towel over grid. Drizzle with liquid dishwashing detergent and pour water over grid. This will make cleaning of the pan easier, or the broiler pan can be lined with aluminum foil to make cleaning easier. Be sure the foil extends up the side of the pan. Although it is not recommended, the grid can also be covered with foil. Be sure to slit openings to conform with the openings in the grid so melted fat can drain through to prevent splattering, smoking, or the possibility of grease fire.

Rack Positions for Broiling

Note: Note the approximate effective cooking areas on the broiler grid for each rack position. Position 4 is closest to the broiler with a 25% effective cooking area. Position 1 is closest to the oven bottom with 95% effective cooking area.

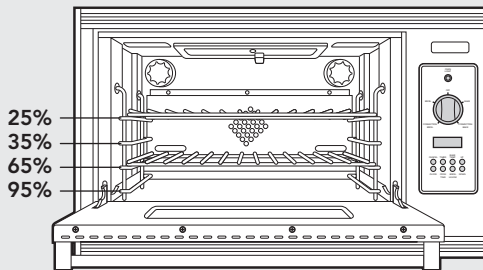

Broiling

Broiling Chart

Type and Cut of Meat	Weight	Setting	Rack	Time (min)
BEEF				
Sirloin, 1"				
Rare	12 oz	Broil	3	7
Medium	12 oz	Broil	3	9
Well done	12 oz	Broil	2	12
T-Bone, 3/4"				
Rare	10 oz	Broil	3	5
Medium	10 oz	Broil	3	7
Well done	10 oz	Broil	2	10
Hamburger, 1/2"				
Medium	1/4 lb.	Broil	2	7
Well done	1/4 lb.	Broil	2	10
CHICKEN				
Bnls breast, 1"	1/2 lb.	Broil	2	15
Bnls breast, 1"	1/2 lb.	Convection Broil	2	15
Bone-in breast	2 - 3 lbs total	Broil	2	22
Bone-in breast	2 - 3 lbs total	Convection Broil	2	20
Chicken quarters	2 - 3 lbs total	Broil	2	22
Chicken quarters	2 - 3 lbs total	Convection Broil	2	20
HAM				
Ham slice, 1"	1 lb.	Broil	2	10
LAMB				
Rib chops, 1"	12 oz.	Broil	2	7
PORK				
Loin chops, 3/4"	1 lb.	Convection Broil	2	12
Bacon		Broil	2	6
FISH				
Salmon steak	1 lb.	Broil	2	7
Fillets	1 lb.	Broil	2	6

Note: The above information is given as a guide only.

Convection Dehydrate

Convection Dehydrate (CONVECTION BAKE)

This oven is designed not only to cook, but also to dehydrate fruits and vegetables. With the oven function selector set to Convection Bake and the temperature control on 170° F (76.6° C), warm air is circulated by a motorized fan in the rear of the oven. Over a period of time, the water is removed from the food by evaporation. Removal of water inhibits growth of microorganisms and retards the activity of enzymes. It is important to remember that dehydration does not improve the quality, so only fresh, top-quality foods should be used.

1. Prepare the food as recommended.
2. Arrange the food on drying racks (not included with the oven; contact a local store handling specialty cooking utensils).
3. Set the appropriate low temperature and turn the selector to "CONVECTION BAKE".

CAUTION

You must carefully check the food during the dehydration process to ensure that it does not catch fire.

Convection Defrost

Convection Defrost (CONVECTION BAKE)

With the selector set to Convection Bake and the temperature control off, air is circulated by a motorized fan in the rear of the oven. The fan accelerates natural defrosting of the food without heat. To avoid sickness and food waste, **DO NOT** allow defrosted food to remain in the oven for more than two hours.

1. Place the frozen food on a baking sheet.
2. Set the temperature control to "OFF".
3. Turn the selector to "CONVECTION BAKE".

WARNING

To avoid sickness and food waste, **DO NOT** allow defrosted food to remain in the oven for more than two hours.

NOTICE

DO NOT turn the Temperature Control on during defrosting. Turning the convection fan on will accelerate the natural defrosting of the food without the heat.

Cleaning and Maintenance

Any piece of equipment works better and lasts longer when maintained properly and kept clean. Cooking equipment is no exception. Your oven must be kept clean and maintained properly.

Oven Surfaces

Several different finishes have been used in your oven. Cleaning instructions for each surface are given below. **NEVER USE AMMONIA, STEEL WOOL PADS OR ABRASIVE CLOTHS, CLEANSERS, OVEN CLEANERS, OR ABRASIVE POWDERS. THEY CAN PERMANENTLY DAMAGE YOUR OVEN.**

Control Knobs

MAKE SURE ALL THE CONTROL KNOBS POINT TO THE OFF POSITION BEFORE REMOVING. Pull the knobs straight off. Wash in detergent and warm water. Dry completely and replace by pushing firmly onto stem. **DO NOT USE** any cleaners containing ammonia or abrasives. They could remove the graphics from the knob.

Stainless Steel Parts

All stainless steel body parts should be wiped regularly with hot soapy water at the end of each cooling period and with a liquid cleaner designed for that material when soapy water will not do the job. **DO NOT** use steel wool, abrasive cloths, cleansers, or powders. If necessary, scrape stainless steel to remove encrusted materials, soak the area with hot towels to loosen the material, then use a wooden or nylon spatula or scraper. **DO NOT** use a metal knife, spatula, or any other metal tool to scrape stainless steel. **DO NOT** permit citrus or tomato juice to remain on stainless steel surface, as citric acid will permanently discolor stainless steel. Wipe up any spills immediately.

Cleaning and Maintenance

Glass Surfaces

Clean with detergent and warm water. Glass cleaner can be used to remove fingerprints. If using glass cleaner ammonia, make sure that it does not run down on exterior door surface.

Brass Parts

CAUTION

All special ordered brass parts are coated with an epoxy coating. **DO NOT USE BRASS CLEANERS OR ABRASIVE CLEANERS ON ANY BRASS PARTS.** All brass body parts should be wiped regularly with hot soapy water. When hot soapy water will not do the job, use every day household cleaners that are not abrasive.

Broiler Pan and Grid

Clean with detergent and hot water. For stubborn spots, use a soap-filled steel wool pad.

Oven Racks

Clean with detergent and hot water. Stubborn spots can be scoured with a soap-filled steel wool pad.

WARNING



BURN OR ELECTRICAL SHOCK HAZARD

Make sure all controls are OFF and oven is COOL before cleaning. Failure to do so can result in burns or electrical shock.

Replacing Oven Lights

WARNING



ELECTRICAL SHOCK HAZARD

Disconnect the electric power at the main fuse or circuit breaker before replacing bulb.

WARNING

DO NOT touch bulb with bare hands. Clean off any signs of oil from the bulb and handle with a soft cloth.

1. Unscrew glass light cover.
2. Use an oven mitt during bulb removal to protect your hand in case the bulb breaks.
3. Replace the bulb with a 120 volt, 40-watt appliance bulb.
4. Replace the light cover
5. Reconnect power at the main fuse or circuit breaker.

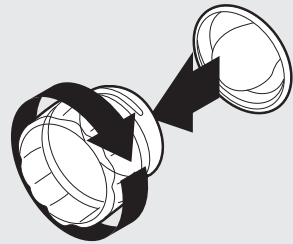

Power Failure

DO NOT attempt to use during power failure. Unit will not function.

Troubleshooting

Problem	Possible Cause and/or Remedy
Oven will not function.	Oven is not connected to electrical power: Have electrician check power circuit breaker, wiring, and fuses.
Broil does not work.	HI/LO setting has not been set using "UP" or "DOWN" button.
Oven light will not work.	Light bulb is burned out. Oven is not connected to power.
Service codes appear in digital display.	Disconnect electrical supply to the oven and call an authorized servicer.
Strong odor and/or smoke is noticed first few times oven is used.	This is normal burn off of insulation and protective oils in oven. This will go away after using oven a few times.

Service Information

If service is required, call your dealer or authorized service agency. The name of the authorized service agency can be obtained from the dealer or distributor in your area.

Have the following information readily available.

- Model number
- Serial number
- Date purchased
- Name of dealer from whom purchased

Clearly describe the problem that you are having. If you are unable to obtain the name of an authorized service agency, or if you continue to have service problems, contact Viking Range Corporation at 1-888-VIKING1 (845-4641), or write to:

**VIKING RANGE CORPORATION
PREFERRED SERVICE
1803 Hwy 82W
Greenwood, Mississippi 38930 USA**

Record the information indicated below. You will need it if service is ever required. The model and serial number for your oven can be found by looking behind the access panel on the bottom frame.

Model no. _____ Serial no. _____

Date of purchase _____ Date installed _____

Dealer's name _____

Address _____

If service requires installation of parts, use only authorized parts to insure protection under the warranty.

KEEP THIS MANUAL FOR FUTURE REFERENCE.

Warranty

PROFESSIONAL SERIES BUILT-IN GAS OVENS WARRANTY

ONE YEAR FULL WARRANTY

Built-in gas ovens (VGSO Series) and all of their component parts, except as detailed below*, are warranted to be free from defective materials or workmanship in normal household use for a period of twelve (12) months from the date of original retail purchase. Viking Range Corporation, warrantor, agrees to repair or replace, at its option, any part which fails or is found to be defective during the warranty period.

*Painted and decorative items are warranted to be free from defective materials or workmanship for a period of ninety (90) days from the date of original retail purchase. ANY DEFECTS MUST BE REPORTED TO THE SELLING DEALER WITHIN NINETY (90) DAYS FROM DATE OF ORIGINAL RETAIL PURCHASE.

Viking Range Corporation uses the most up-to-date processes and best materials available to produce all color finishes. However, slight color variation may be noticed because of the inherent differences in painted parts and porcelain parts as well as differences in kitchen lighting, product locations, and other factors.

FIVE YEAR LIMITED WARRANTY

Any oven tubular burner which fails due to defective materials or workmanship in normal household use during the second through fifth year from the date of original retail purchase will be repaired or replaced, free of charge for the part itself, with the owner paying all other costs, including labor.

TEN YEAR LIMITED WARRANTY

Any porcelain oven or porcelain inner door panel which rusts through due to defective material or workmanship in normal household use during the second through the tenth year from the date of original retail purchase will be repaired or replaced, free of charge for the part itself, with the owner paying all other costs, including labor.

NINETY (90) DAY RESIDENTIAL PLUS WARRANTY

This warranty applies to applications where use of the product extends beyond normal residential use. Examples are, but not limited to, bed and breakfasts, fire stations, private clubs, churches, etc. This warranty excludes all commercial locations such as restaurants, food service locations and institutional food service locations.

This warranty extends to the original purchaser of the product warranted hereunder and to each transferee owner of the product during the term of the warranty.

This warranty shall apply to products purchased and located in the United States and Canada. Products must be purchased in the country where service is requested. Warranty labor shall be performed by an authorized Viking Range Corporation service agency or representative. Warranty shall not apply to damage resulting from abuse, accident, natural disaster, loss of electrical power to the product for any reason, alteration, outdoor use, improper installation, improper operation, or repair or service of the product by anyone other than an authorized Viking Range Corporation service agency or representative. This warranty does not apply to commercial usage. Warrantor is not responsible for consequential or incidental damage whether arising out of breach of warranty, breach of contract, or otherwise. Some jurisdictions do not allow the exclusion or limitation of incidental or consequential damages, so the above limitation or exclusion may not apply to you.

Owner shall be responsible for proper installation, providing normal care and maintenance, providing proof of purchase upon request, and making the appliance reasonably accessible for service. If the product or one of its component parts contains a defect or malfunction during the warranty period, after a reasonable number of attempts by the warrantor to remedy the defects or malfunctions, the owner is entitled to either a refund or replacement of the product or its component part or parts. Warrantor's liability on any claim of any kind, with respect to the goods or services covered hereunder, shall in no case exceed the price of the goods or service or part thereof which gives rise to the claim.

WARRANTY SERVICE: Under the terms of this warranty, service must be performed by a factory authorized Viking Range Corporation service agent or representative. Service will be provided during normal business hours, and labor performed at overtime or premium rates shall not be covered by this warranty. To obtain warranty service, contact the dealer from whom the product was purchased, an authorized Viking Range Corporation service agent, or Viking Range Corporation. Provide model and serial number and date of original purchase. For the name of your nearest authorized Viking Range Corporation service agency, call the dealer from whom the product was purchased or Viking Range Corporation. **IMPORTANT:** Retain proof of original purchase to establish warranty period.

The return of the Owner Registration Card is not a condition of warranty coverage. You should, however, return the Owner Registration Card so that Viking Range Corporation can contact you should any question of safety arise which could affect you.

Any implied warranties of merchantability and fitness applicable to the above described oven tubular burner, porcelain oven, or porcelain inner door panel are limited in duration to the period of coverage of the applicable express written limited warranties set forth above. Some jurisdictions do not allow limitations on how long an implied warranty lasts, so the above limitation may not apply to you. This warranty gives you specific legal rights, and you may also have other rights which may vary from jurisdiction to jurisdiction.

VIKING RANGE CORPORATION

111 Front Street • Greenwood, Mississippi 38930 USA • (662) 455-1200



Viking Range Corporation
111 Front Street
Greenwood, Mississippi 38930 USA
(662) 455-1200

For product information,
call 1-888-VIKING1 (845-4641)
or visit the Viking Web site at
vikingrange.com