

Service Handbook

Standard Condensing Residential Gas Tankless Water Heater

Residential On-Demand Gas Tankless Water Heater
(X3® TECHNOLOGY available on some models)



MODELS:
TM-160M-N, TM-180M-N, TM-199M-N
TM-160X3-N, TM-180X3-N, TM-199X3-N

NATURAL GAS ONLY
(M MODELS AVAILABLE IN US ONLY)

THIS SERVICE HANDBOOK IS FOR USE BY QUALIFIED SERVICE PROFESSIONALS ONLY.

TABLE OF CONTENTS

BASICS.....	2	SERVICE (COMBUSTION COMPONENTS)	58
Typical Installation (X3® Model Shown).....	3	Gas Inlet Connector	58
IMPORTANT SAFETY INFORMATION.....	4	Gas Valve	60
RISKS DURING INSTALLATION AND MAINTENANCE.....	5	Fan Assembly.....	64
RISKS DURING OPERATION	5	Gas Manifold	68
Tools Required for Servicing Tankless Gas Water Heater Models.....	6	Ignitor Rod & Flame Sensor Rod Assembly.....	71
COMPONENT TESTING AND DIAGNOSIS	7	Burner Assembly	73
Hi-Limit Switch (Manual)	7	Primary & Secondary Heat Exchangers (HEX), OHCF Wire	76
Cascade System	8	SERVICE (WETTED COMPONENTS)	86
OPERATION	12	Water Inlet Assembly	86
Display Overview	12	Flow Control Valve.....	88
Temperature Settings.....	13	Cartridge Manifold	90
Configuration Mode (C Mode).....	14	Bypass Valve	92
Unit Conversion Mode.....	16	Water Outlet Assembly	94
Information Mode (P Mode)	17	Water Tubing	96
MAINTENANCE	18	Condensate Trap.....	100
Descaling	18	Heat Exchanger (HEX) Drain	102
Unit Draining & Power Outage (Freeze Protection).....	20	Inlet Water Filter	104
Discharge Condensate	20	SERVICE (FLUE & AIR INTAKE COMPONENTS)	105
Inlet Water Filter	20	Emission Port Cap.....	105
X3® & Bypass Cartridge	21	Flue & Air Intake O-Ring	106
TROUBLESHOOTING	22	Flue & Air Intake Clamp.....	108
General Troubleshooting	22	SERVICE (MASTER KITS)	109
Error Codes.....	24	Gasket Master Kit	109
Fault Analysis of Error Codes	25	Fastener Master Kit	112
SERVICE (ELECTRONIC & WIRING COMPONENTS)	32	O-Ring Master Kit	114
User Interface Module & Wire Harness.....	32	COMPONENTS	116
Hi-Limit Switch (Manual Reset)	34	Internal Component View (A)	116
Freeze Protection Thermostat	35	Internal Component View (B)	117
Heater Block Upper Wiring Assembly.....	36	External Component View.....	118
Heater Block Lower Wiring Assembly.....	38	Internal / External Component List	119
Main Wiring Harness Assembly.....	42	DIAGRAMS	120
Freeze Protection & Power Wire Harness Assembly	46	Electrical Wiring Diagram	120
Printed Circuit Board	48	Thermistor Resistance Vs Temperature Charts.....	121
Ignitor Assembly.....	50		
Flame Sensor Wire.....	51		
Exhaust and Water Inlet Thermistor.....	52		
Heat Exchanger and Water Outlet Thermistor	55		

TYPICAL INSTALLATION (X3® MODEL SHOWN)

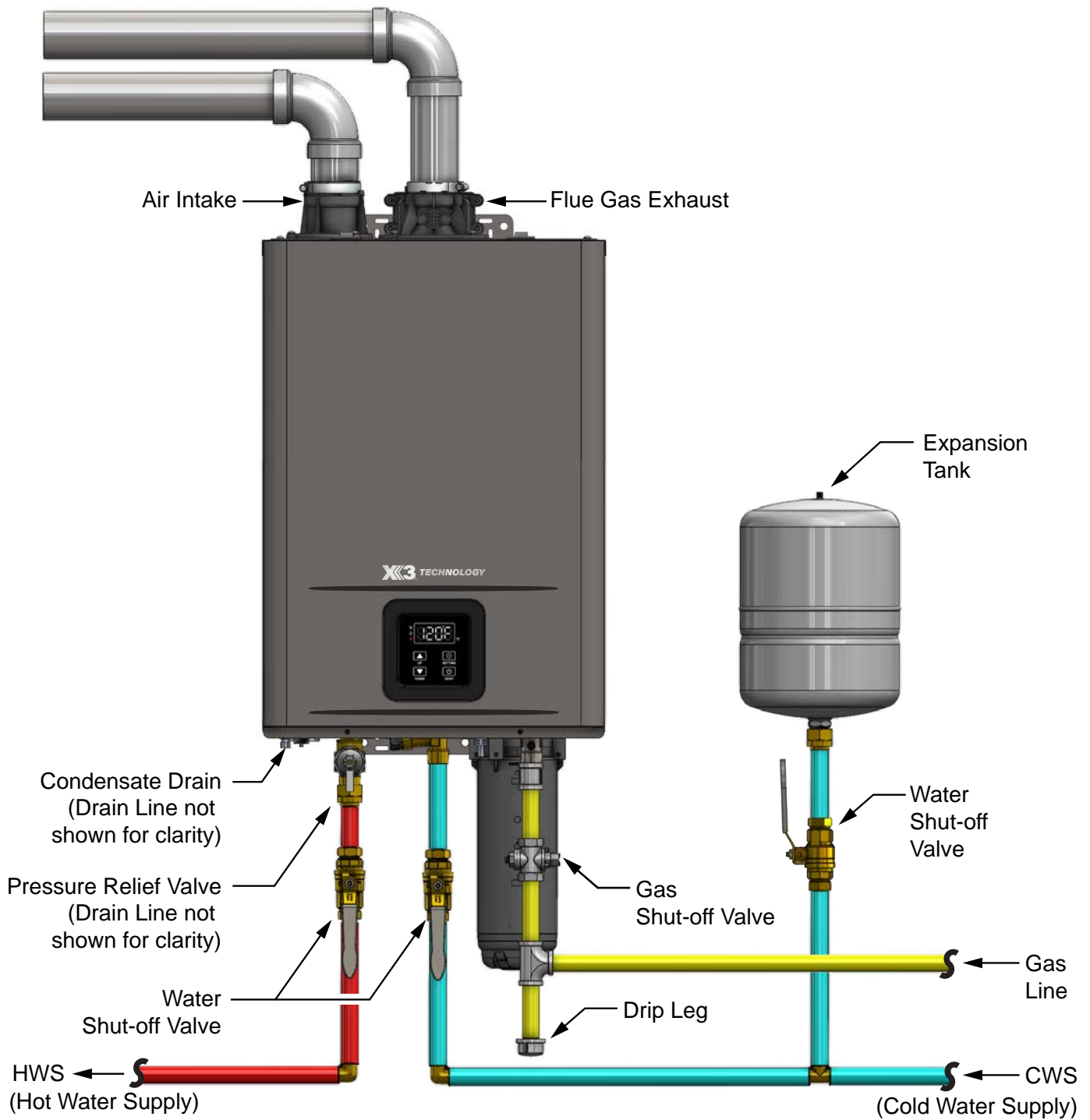



IMPORTANT SAFETY INFORMATION

Read and follow all safety messages and instructions in this manual.



This is the safety alert symbol. It is used to alert you to potential physical injury hazards. Obey all safety messages that follow this symbol to avoid possible property damage, serious injury or death. Do not remove any permanent instructions, labels, or the data plate from either the outside of the water heater or on the inside of the access panels. Keep this manual near the water heater.

 DANGER	DANGER indicates a hazardous situation that, if not avoided, will result in death or serious injury.
 WARNING	WARNING indicates a hazardous situation that, if not avoided, could result in death or serious injury.
 CAUTION	CAUTION indicates a hazardous situation that, if not avoided, could result in minor or moderate injury.
NOTICE	NOTICE indicates practices not related to physical injury.

▲ WARNING! If the information in these instructions is not followed exactly, a fire or explosion may result causing property damage, personal injury or death. Do not store or use gasoline or other flammable vapors and liquids in the vicinity of this or any other appliance.

An odorant is added by the gas supplier to the gas used by this water heater. This odorant may fade over an extended period of time. Do not depend upon this odorant as an indication of leaking gas. We recommend installing a fuel gas and carbon monoxide detector.

This product is certified to comply with a maximum weighted average of 0.25% lead content as required in some areas.

Important information to keep

Fill out this section and keep this manual in the pocket of the water heater for reference.

Date Purchased:

Model Number:

Serial number:

Maintenance performed:* Date:

**Operate the Pressure Relief Valve annually and inspect Pressure Relief Valve every 2-4 years (see the label on the Pressure Relief Valve for maintenance schedule). If no label is attached to the Pressure Relief Valve, follow the instructions in the Maintenance section of this manual. See the Regular Maintenance section for more information about maintaining this water heater.*

IMPORTANT SAFETY INFORMATION

To reduce the risk of property damage, serious injury or death, read and follow the precautions below, all labels on the water heater, and the safety messages and instructions throughout this manual.

RISKS DURING INSTALLATION AND MAINTENANCE



Lifting Risk

⚠ WARNING! The water heater is heavy. Follow these

precautions to reduce the risk of property damage, injuries from lifting or impact injuries from dropping the water heater.

- Use at least two people to lift the water heater.
- Be sure you both have a good grip before lifting.
- Use an appliance dolly or hand truck to move the water heater.



Explosion Risk

⚠ WARNING! This water heater is designed for Natural Gas operation only. Refer to the water heater's rating plate. Failure to follow these instructions can result in serious injury or death from explosion, fire or carbon monoxide poisoning.

- **DO NOT** connect this Natural Gas water heater to an L.P. gas supply.
- Use a new gas supply line approved for Natural Gas that meets local and state/provincial codes.
- Install a full port shut-off valve on the gas supply line.
- Maintain the Pressure Relief Valve properly. Follow the maintenance instructions provided by the manu-

facturer of the Pressure Relief Valve (label attached to Pressure Relief Valve). If no label is attached to the Pressure Relief Valve, follow the instructions in the Pressure Relief Valve Maintenance section of this manual. An explosion could occur if the Pressure Relief Valve or discharge pipe is blocked. Do not cap or plug the Pressure Relief Valve or discharge pipe.

Gas Pressure

⚠ WARNING! The Natural Gas supply pressure must not exceed the maximum supply pressure as stated on the water heater's rating plate. Have a qualified person (licensed plumber, gas company personnel, or authorized service technician) check for proper gas pressure. Gas pressures exceeding the maximum supply pressure as stated on the water heater's rating plate can result in serious injury or death from explosion or fire.

RISKS DURING OPERATION

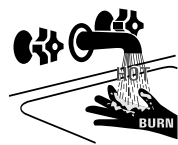

Scalding Risk

This water heater can make water hot enough to cause severe burns instantly, resulting in severe injury or death.

- Feel water before bathing or showering.
- To reduce the risk of scalding, install Thermostatic Mixing Valves (temperature limiting valves) at each point-of-use. These valves automatically mix hot and cold water to limit the temperature at the tap. Mixing valves are available at your local plumbing supplier. Follow the manufacturer's instructions for installation and adjustment of the valves.

- Water temperatures over 125°F (52°C) can cause severe burns instantly or death from scalding. The water temperature is set at 120°F (49°C) from the factory to minimize any scalding risk. Before bathing or showering, always check the water temperature. Higher temperatures increase the risk of scalding, but even at 120°F, hot water can scald. If you choose a higher temperature setting, Thermostatic Mixing Valves located at each point-of-use are particularly important to help avoid scalding.

Table 1: Scalding Table

Temperature	Time to Produce a Serious Burn
120°F (49°C)	More than 5 minutes
125°F (52°C)	1½ to 2 minutes
130°F (54°C)	About 30 seconds
135°F (57°C)	About 10 seconds
140°F (60°C)	Less than 5 seconds
145°F (63°C)	Less than 3 seconds
150°F (66°C)	About 1½ seconds
155°F (68°C)	About 1 second

For more information about changing the factory temperature setting, refer to the "Temperature Settings" section in this manual.

- Water temperature will be hotter if someone adjusted the set temperature to a higher setting.
- Should overheating occur or the burner fail to shut off, turn off the manual gas supply valve to the water heater and call a qualified person.

To reduce the risk of unusually hot water reaching the fixtures in the house, install Thermostatic Mixing Valves at each point-of-use.

If anyone in your home is at particular risk of scalding (for example, the elderly, children, or people with

IMPORTANT SAFETY INFORMATION

disabilities) or if there is a local code or state/provincial law requiring a certain water temperature at the hot water tap, these precautions are particularly important.

According to a national standard American Society of Sanitary Engineering (ASSE 1070) and most local plumbing codes, the water heater's thermostat should not be used as the sole means to regulate water temperature and avoid scalds.

Water Contamination Risk

Do not use chemicals that could contaminate the potable water supply. Do not use piping that has been treated with chromates, boiler seal, or other chemicals. Suitable for potable water heating only.



Fire Risk

To reduce the risk of a fire that could result in property damage, or serious injury or death:

- Do not store things that can burn easily such as paper or clothes next to the water heater.
- Do not store or use gasoline or other flammable substances in the vicinity of this or any other appliance.
- Do not use this appliance if any part has been in contact with or been immersed in water. Immediately call a qualified installer or service agency to replace a flooded water heater. Do not attempt to repair the unit. It must be replaced.



Explosion Risk

High pressures in the water heater can cause an explosion resulting in property damage, serious injury or death. A Pressure Relief Valve is required to be installed on the water heater. A Pressure Relief Valve is supplied

with X3® models and shall be field supplied for M models. Additional pressure protective equipment may be required by local codes.

A nationally recognized testing laboratory maintains public inspection of the valve production process and certifies that it meets the requirements for Relief Valves for Hot Water Supply Systems, ANSI Z21.22. The Pressure Relief Valve's relief pressure must not exceed the working pressure rating of the water heater as stated on the rating plate.

Carbon Monoxide Risk



▲ WARNING! This water heater operates by burning gas. Carbon monoxide is a colorless, odorless, gas that is a by-product of burning of fuels such as coal, wood, charcoal, oil, kerosene, propane, and natural gas. Breathing excessive and abnormal amounts of carbon monoxide can cause carbon monoxide poisoning, resulting in serious injury or death. This water heater must be supplied with adequate combustion air and must be properly vented to the outdoors. Have a qualified person (licensed plumber, authorized gas company personnel, or authorized service technician) install the venting system using these installation instructions.

Install a fuel gas and carbon monoxide detector in the living areas of your home.

Failure to follow these instructions can result in serious injury or death from carbon monoxide poisoning.

Tools Required for Servicing Tankless Gas Water Heater Models

- Safety gloves
- Non-contact circuit tester
- Common hand tools (screwdrivers, pliers, wire cutters, wrenches, etc.)
- 12" Magnetized Phillips screwdriver
- Plastic scraper
- Digital multimeter (with alligator leads and continuity tester)
- Clamp style amp meter
- Water pressure gauge
- Garden hose (draining tank)
- Bucket
- Thermometer (2x)
- Pipe wrench for water and gas connections
- Pipe joint compound or thread sealant tape
- Masking tape and a permanent marker to mark wires
- Cable ties (various sizes)
- Mini Pick or Hook
- Installation Instruction/Use and Care Guide

COMPONENT TESTING AND DIAGNOSIS

Hi-Limit Switch (Manual)

The Hi-Limit switch (manual) can be manually reset by depressing the button in the center of the switch. This switch activates at 217°F (103°C). It will flash an E002 error code.

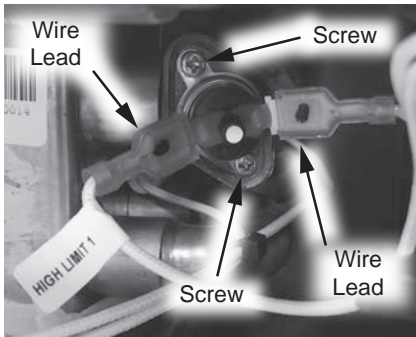

Figure 1 - Hi-Limit Switch (Manual)

COMPONENT TESTING AND DIAGNOSIS

COMPONENT DATA

Cascade System

Installation and Configuration

The Cascade System allows up to 12 heaters of the same input model to be linked electronically for various flow rate demands.

The Installation Instructions and Use & Care Guide provides the correct procedures for installing and configuring the Cascade System.

One heater **MUST** be set as the Parent water heater. The Parent water heater will instruct the Child water heaters in the Cascade System to activate and deactivate as necessary.

Mode C13 sets the Parent water heater by identifying the number of Child water heaters in the Cascade System.

Mode C14 identifies the water heater number in the system. The Parent heater will always have a value of 1. The Child water heaters will have a value of 2 up to 12. See Figure 2 below for an example of a typical Cascade System and how it is configured.

Priority Order Determination

The heaters will rotate the Priority water heater (first to activate) on a weekly basis. The Priority water heater will be set based on the water heater with the least combustion time. The second water heater will be set based on the water heater with the second least combustion time, and so on for the remaining water heaters in the Cascade System. The combustion time for each water heater can be viewed in mode P20. See Table 15 on page 17 for information on accessing P mode.

Activation and Deactivation Logic

Water heaters in the Cascade System will activate and deactivate based on the water temperature rise of the Priority water heater. Tables 2-5 (pages 10 & 11) list the activation and deactivation of the model based on the Priority water heater's temperature rise (ΔT):

$$\Delta T = T_{set} - T_{in}$$

T_{set} = Set Temperature
 T_{in} = Inlet Temperature

The tables show the system flow rate when the next water heater will activate and likewise deactivate.

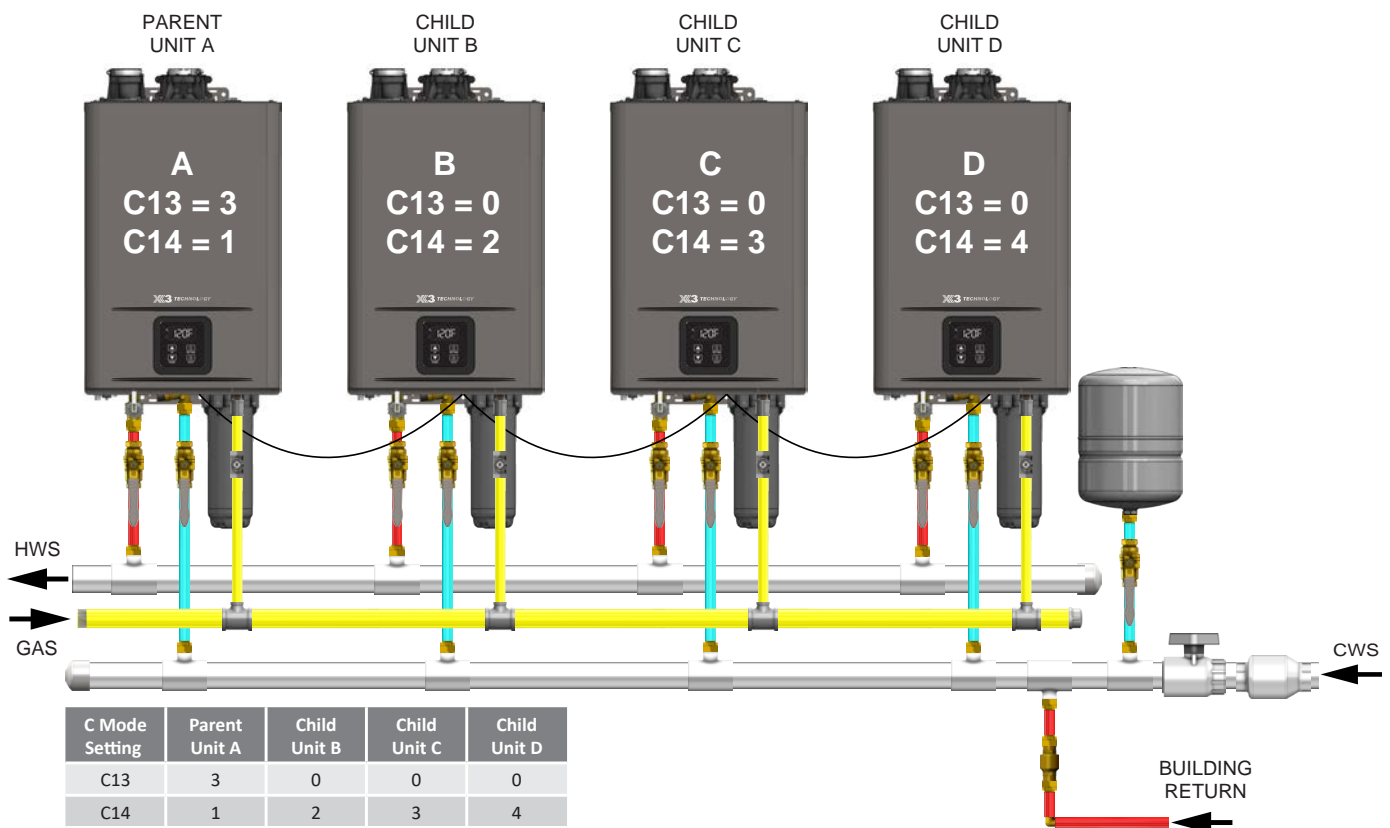

Figure 2 - Cascade System Installation & Configuration



COMPONENT TESTING AND DIAGNOSIS

Testing a Cascade System

Verify the system is installed as shown in the water heater's Installation Instruction Use and Care & Guide. The water piping must be installed in a "Reverse-Return" format to promote equal "path of resistance" through each water heater in the Cascade System.

IMPORTANT: Unequal paths of resistance will cause some water heaters to operate more frequently than other units in the Cascade System and can lead to fluctuation of outlet water temperatures.

If the issue is an error code, check for the following:

See "Cascade System Example" on page 24 for more information on how error codes will display in a Cascade System.

1. Verify the heaters are set properly in the C13 & C14 modes.
 - Press and hold the "UP" button and the "SETTING" button for 5 seconds to access C Mode.
 - Press the "UP" button or the "DOWN" button to search for the desired C Code.
 - Press and hold the "UP" button and the "SETTING" button for 5 seconds to return the display to normal operation.
2. Test the water heater(s) with an error code as an individual unit, removing it from the Cascade System. Do this by changing mode C14 to 0.

NOTICE: Record the original value of C14 before changing to 0. This value will need to be reentered once the error code has been resolved.

- Press and hold the "UP" button and the "SETTING" button for 5 seconds to access C Mode.

- Press the "UP" button or the "DOWN" button to search for the desired C Code.
- If applicable, press the "SETTING" button to adjust the value of the C Code using the "UP" and "DOWN" buttons. The value will flash.
- Press the "SETTING" button again to confirm the new value selected is correct.
- Press and hold the "UP" button and the "SETTING" button for 5 seconds to return the display to normal operation.

NOTICE: If the problem water heater is the Parent unit, you will need to set the next water heater in line as the new Parent unit.

3. Disconnect the cascade wiring from the water heater. Cycle the power of the heater off, then on. **DO NOT** use the ON/OFF button on the user interface module.
 - Before proceeding, determine if isolation valves are installed. If so, close the outlet valve and hook up a hose to the isolation valve port. Run the hose to a drain or outside in order to operate the water heater as an individual water heater.
 - If isolation valves are not installed, you will have to test the water heater while the overall system is not in use.
4. Refer to the "Fault Analysis of Error Codes" section on page 25 for error code information.
5. Once the error code is resolved, reattach the cascade wire to the water heater's PCB. Return to mode C14 and set the display to the previous value recorded in Step 2.

If the issue is water temperature fluctuations, check for the following:

- Verify the plumbing is reverse return.
- Verify the outlet water temperature of each active water heater via the P01 mode.
- Verify the flow rate through each active water heater via the P03 mode. A reduced flow rate by one heater may indicate a clogged inlet filter, insufficient gas supply, too large gas pressure drop, blocked exhaust and/or intake, etc.
- Verify the C mode settings are accurate for the installation.
- If a recirculation system is set up, verify the check valve on the return line prior to the inlet water tee is operating correctly. An improperly operating check valve can reduce the recirculation pump's flow rate causing temperature fluctuations.



COMPONENT TESTING AND DIAGNOSIS

Table 2: Activation ΔT and Flow Rates (TM-199 Series C0=0)

Activation: Altitude 0 – 1,999 ft. (C0=0)									
ΔT Units	TM-160 (gpm)			TM-180 (gpm)			TM-199 (gpm)		
	< 60°F	60°F - 80°F	> 80°F	< 60°F	60°F - 80°F	> 80°F	< 60°F	60°F - 80°F	> 80°F
1 to 2	3.7	2.6	2.0	4.1	2.9	2.3	4.6	3.2	2.6
2 to 3	7.4	5.3	4.1	8.3	5.9	4.7	9.2	6.5	5.1
3 to 4	11.0	7.9	6.1	12.4	8.8	7.0	13.7	9.7	7.7
4 to 5	14.7	10.5	8.1	16.5	11.7	9.3	18.3	12.9	10.2
5 to 6	18.4	13.1	10.1	20.6	14.6	11.6	22.9	16.1	12.8
6 to 7	22.1	15.8	12.2	24.8	17.6	14.0	27.5	19.4	15.3
7 to 8	25.7	18.4	14.2	28.9	20.5	16.3	32.0	22.6	17.9
8 to 9	29.4	21.0	16.2	33.0	23.4	18.6	36.6	25.8	20.4
9 to 10	33.1	23.6	18.2	37.1	26.3	20.9	41.2	29.0	23.0
10 to 11	36.8	26.3	20.3	41.3	29.3	23.3	45.8	32.3	25.5
11 to 12	40.4	28.9	22.3	45.4	32.2	25.6	50.3	35.5	28.1

Table 3: Deactivation ΔT and Flow Rates (TM-199 Series C0=0)

Deactivation: Altitude 0 – 1,999 ft. (C0=0)									
ΔT Units	TM-160 (gpm)			TM-180 (gpm)			TM-199 (gpm)		
	< 60°F	60°F - 80°F	> 80°F	< 60°F	60°F - 80°F	> 80°F	< 60°F	60°F - 80°F	> 80°F
12 to 11	32.3	23.1	18.1	36.3	25.7	20.6	40.4	28.1	22.4
11 to 10	29.3	21.0	16.4	33.0	23.3	18.7	36.7	25.6	20.3
10 to 9	26.4	18.9	14.8	29.7	21.0	16.8	33.0	23.0	18.3
9 to 8	23.5	16.8	13.1	26.4	18.7	14.9	29.3	20.5	16.3
8 to 7	20.6	14.7	11.5	23.1	16.4	13.1	25.7	17.9	14.3
7 to 6	17.6	12.6	9.8	19.8	14.0	11.2	22.0	15.4	12.2
6 to 5	14.7	10.5	8.2	16.5	11.7	9.3	18.3	12.8	10.2
5 to 4	11.8	8.4	6.5	13.2	9.4	7.4	14.6	10.3	8.2
4 to 3	8.9	6.3	4.9	9.9	7.1	5.6	11.0	7.7	6.2
3 to 2	5.9	4.2	3.2	6.6	4.7	3.8	7.4	5.2	4.1
2 to 1	2.9	2.1	1.7	3.3	2.3	1.9	3.7	2.6	2.0



COMPONENT DATA

COMPONENT TESTING AND DIAGNOSIS

Table 4: Activation ΔT and Flow Rates (TM-199 Series C0=1,2)

Activation: Altitude 2,000 – 7,800 ft. (C0=1,2)									
ΔT Units	TM-160 (gpm)			TM-180 (gpm)			TM-199 (gpm)		
	< 60°F	60°F - 80°F	> 80°F	< 60°F	60°F - 80°F	> 80°F	< 60°F	60°F - 80°F	> 80°F
1 to 2	2.5	1.8	1.4	2.8	2.0	1.6	3.1	2.2	1.7
2 to 3	4.9	3.5	2.7	5.5	3.9	3.1	6.1	4.3	3.4
3 to 4	7.4	5.3	4.1	8.3	5.9	4.7	9.2	6.5	5.1
4 to 5	9.8	7.0	5.4	11.0	7.8	6.2	12.2	8.6	6.8
5 to 6	12.3	8.8	6.8	13.8	9.8	7.8	15.3	10.8	8.5
6 to 7	14.7	10.5	8.1	16.5	11.7	9.3	18.3	12.9	10.2
7 to 8	17.2	12.3	9.5	19.3	13.7	10.9	21.4	15.1	11.9
8 to 9	19.6	14.0	10.8	22.0	15.6	12.4	24.4	17.2	13.6
9 to 10	22.1	15.8	12.2	24.8	17.6	14.0	27.5	19.4	15.3
10 to 11	24.5	17.5	13.5	27.5	19.5	15.5	30.5	21.5	17.0
11 to 12	27.0	19.3	14.9	30.3	21.5	17.1	33.6	23.7	18.7

COMPONENT DATA

Table 5: Deactivation ΔT and Flow Rates (TM-199 Series C0=1,2)

Deactivation: Altitude 2,000 – 7,800 ft. (C0=1,2)									
ΔT Units	TM-160 (gpm)			TM-180 (gpm)			TM-199 (gpm)		
	< 60°F	60°F - 80°F	> 80°F	< 60°F	60°F - 80°F	> 80°F	< 60°F	60°F - 80°F	> 80°F
12 to 11	32.3	23.1	18.1	24.2	17.1	13.7	26.9	18.8	14.9
11 to 10	29.3	21.0	16.4	22.0	15.6	12.5	24.5	17.1	13.6
10 to 9	26.4	18.9	14.8	19.8	14.0	11.2	22.0	15.4	12.2
9 to 8	23.5	16.8	13.1	17.6	12.5	10.0	19.6	13.7	10.9
8 to 7	20.6	14.7	11.5	15.4	10.9	8.7	17.1	12.0	9.5
7 to 6	17.6	12.6	9.8	13.2	9.4	7.5	14.7	10.3	8.2
6 to 5	14.7	10.5	8.2	11.0	7.8	6.2	12.2	8.6	6.8
5 to 4	11.8	8.4	6.5	8.8	6.3	5.0	9.8	6.9	5.5
4 to 3	8.9	6.3	4.9	6.6	4.7	3.7	7.3	5.2	4.1
3 to 2	5.9	4.2	3.2	4.4	3.1	2.5	4.9	3.5	2.7
2 to 1	2.9	2.1	1.7	2.2	1.6	1.3	2.5	1.7	1.4



OPERATION

Display Overview

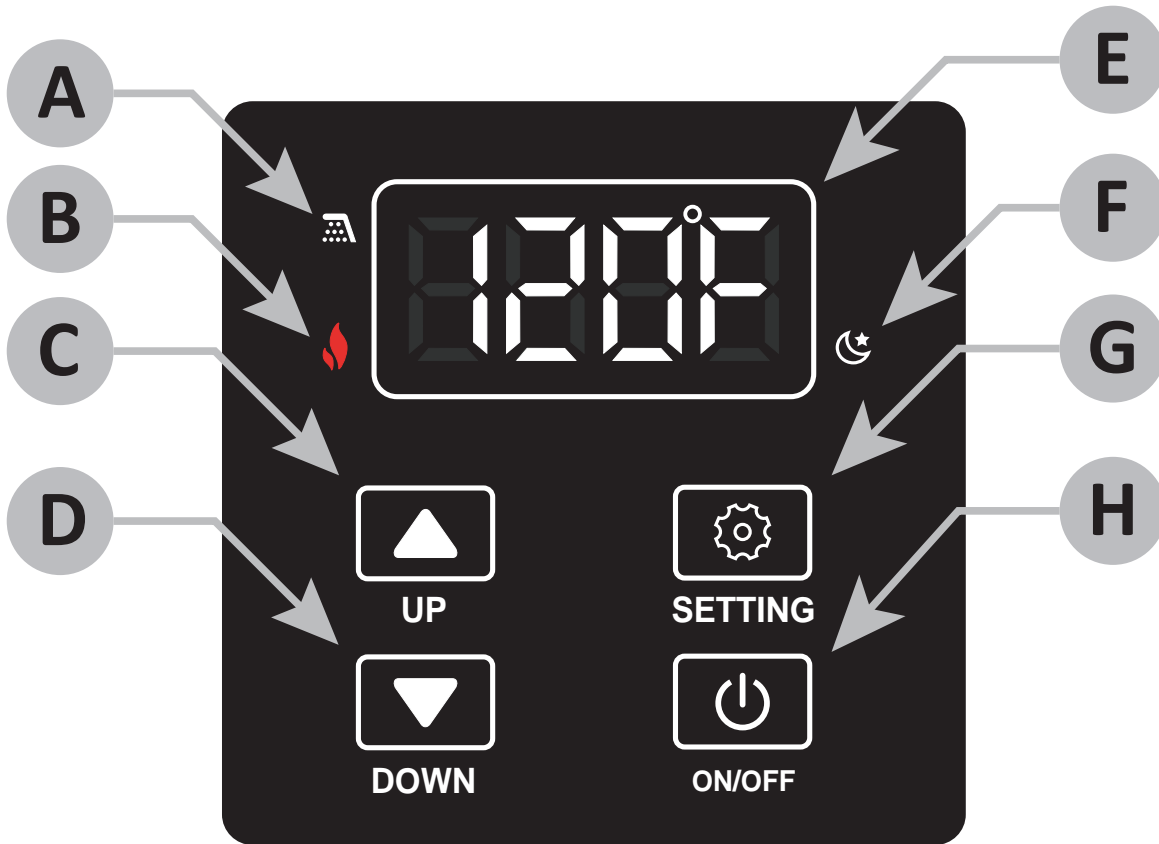

Figure 3 - User Interface Display Diagram

Table 6: User Interface Display

Item	Description
A	Water Flow Detected
B	Flame Detected
C	Up Button
D	Down Button
E	Display
F	Standby Mode
G	Setting Button
H	Operation ON/OFF Button

OPERATION

Temperature Settings

With the installation steps completed, you may adjust the water heater's temperature setting if desired. The water temperature set point is factory set to 120°F (49°C). The temperature set point may be increased or decreased by simply pressing the "UP" button or the "DOWN" button. To set the water heater to a temperature above 125°F (52°C), follow the procedure as outlined in Table 7:

Table 7: Set Temperature Above 125°F (52°C)







	Operation	Screen on the Controller (Built-in & Remote)
1.	Turn on the 120 VAC power supply to the unit.	
2.	Press the "ON/OFF" button on the controller in order to turn the controller on.	
3.	The set point temperature will display as shown in the picture on the right (Example: 120°F).	
4.	⚠ WARNING! Higher temperatures increase the risk of scalding, but even at 120°F (49°C), hot water can scald (page 10). Press and hold the "SETTING" button for 5 seconds to access the water heater Adjustment Mode (A Mode).	LONG PRESS 
5.	The display will flash between code "A00" and the current set temperature. Short press the "SETTING" button to access the temperature setting. The temperature only will flash.	SHORT PRESS 
6.	Press the "UP" button and the "DOWN" button to select the desired set point temperature. See Table 18 below for available set point temperatures.	
7.	Short press the "SETTING" button again to execute the change.	SHORT PRESS 
8.	Press and hold the "SETTING" button for 5 seconds to return the display to normal operation. The new temperature set point will appear (Example: 130°F).	

Table 8: Water Heater Temperature Set Points

°F	100	102	104	106	108	110	115	120*	125	130	135	140
°C	38	39	40	41	42	43	46	49*	52	54	57	60

*Factory setting (Default): 120°F (49°C).



OPERATION

Configuration Mode (C Mode)

You can configure the water heater to accommodate your application from C Mode. Follow the procedure below to access C Mode and to properly configure the water heater for your application:

1. Press and hold the "UP" button and the "SETTING" button for 5 seconds to access C Mode.
2. Press the "UP" button or the "DOWN" button to search for the desired C Code.
3. If applicable, press the "SETTING" button to adjust the value of the C Code using the "UP" and "DOWN" buttons. The value will flash.
4. Press the "SETTING" button again to confirm the new value selected is correct.
5. Press and hold the "UP" button and the "SETTING" button for 5 seconds to return the display to normal operation.

Table 9: C Mode Altitude Settings (C01)

Code	Description	Setting	Configuration Options
C01	Altitude Settings	0	0 to 2,000 ft. (0 to 610 m) Elevation
		1	2,001 to 5,400 ft. (611 to 1,645 m) Elevation*
		2	5,401 to 7,800 ft. (1,646 to 2,377 m) Elevation*

*High altitude vent settings above 2000 (609 m) feet will impact some vent length settings. See Table 12.

Table 10: C Vent Size (C08)

Code	Description	Setting	Configuration Options
C08	Vent Size	2	2 Inch
		3	3 Inch

Vent Length Configuration

Before operating the water heater, you must determine the correct vent length setting for your application:

Example:

Ventilation Component	Type	Equivalent Length
Elbows (Table 8)	(1x) 87° Elbow	3 ft. (0.9 m)
Termination (Tables 9 & 10)	Polypropylene (2" Low Profile)	6 ft. (1.8 m)
Horizontal Vent Run	Polypropylene	12 ft. (3.7 m)
Vertical Vent Run	Polypropylene	3 ft. (0.9 m)
Total Vent Length:		24 ft. (7.3 m)

The example to the left assumes a Power Direct Vent installation with 2 inch Polypropylene venting at sea level. Using Table 11 on the following page, the appropriate C02 setting for 24 feet (7.2 m) of venting is **C02 = 2**.

Your Application:

Ventilation Component	Type	Equivalent Length
Elbows (Table 8)		
Termination (Tables 9 & 10)		
Horizontal Vent Run		
Vertical Vent Run		
Total Vent Length:		

Use your total length and the information found in Table 11 or Table 12 (depending on elevation) on the following page to determine the correct vent length setting based on your application.



OPERATION

Table 11: C Mode Vent Length Configuration (C02) for **0-2,000 ft. (0 to 610 m) Elevation**

Code	Vent Material	Vent Size	Vent Configuration	Controller Setting				
				C02 = 0	C02 = 1	C02 = 2	C02 = 3	C02 = 4
C02	PVC	2 Inch	PDV	4-7 ft. (1.2-2.1 m)	8-18 ft. (2.2-5.5 m)	19-31 ft. (5.6-9.5 m)	32-44 ft. (9.6-13.4 m)	45-50 ft. (13.5-15.2 m)
			PV	4-12 ft. (1.2-3.7 m)	13-25 ft. (3.8-7.6 m)	26-50 ft. (7.7-15.2 m)		
		3 Inch	PDV	4-20 ft. (1.2-6.1 m)	21-60 ft. (6.2-18.3 m)	61-140 ft. (18.4-42.7 m)	141-150 ft. (42.8-45.7 m)	
			PV	4-25 ft. (1.2-7.6 m)	26-80 ft. (7.7-24.4 m)	81-150 ft. (24.5-45.7 m)		
	PP	2 Inch	PDV	4-9 ft. (1.2-2.7m)	10-21 ft. (2.8-6.4 m)	22-39 ft. (6.5-11.9 m)	40-50 ft. (12.0-15.2 m)	
			PV	4-12 ft. (1.2-3.7 m)	13-30 ft. (3.8-9.1 m)	31-50 ft. (9.2-15.2 m)		
		3 Inch	PDV	4-20 ft. (1.2-6.1 m)	21-60 ft. (6.2-18.3 m)	61-140 ft. (18.4-42.7 m)	141-150 ft. (42.8-45.7 m)	
			PV	4-25 ft. (1.2-7.6 m)	26-80 ft. (7.7-24.4 m)	81-150 ft. (24.5-45.7 m)		

(PVC = Polyvinyl Chloride, PP = Polypropylene, PDV = Power Direct Vent, PV= Power Vent)

Table 12: C Mode Vent Length Configuration (C02) for **2,001-7800 ft. (611 to 2,377 m) Elevation**

Code	Vent Material	Vent Size	Vent Configuration	Controller Setting				
				C02 = 0	C02 = 1	C02 = 2	C02 = 3	C02 = 4
C02	PVC	2 Inch	PDV	4-7 ft. (1.2-2.1 m)	8-18 ft. (2.2-5.5 m)	19-31 ft. (5.6-9.5 m)	32-44 ft. (9.6-13.4 m)	45-50 ft. (13.5-15.2 m)
			PV	4-12 ft. (1.2-3.7 m)	13-25 ft. (3.8-7.6 m)	26-42 ft. (7.7-12.8 m)	43-50 ft. (12.9-15.2 m)	
		3 Inch	PDV	4-25 ft. (1.2-7.6 m)	26-70 ft. (7.7-21.3 m)	71-150 ft. (21.4-45.7 m)		
			PV	4-35 ft. (1.2-10.7 m)	36-120 ft. (10.8-36.6 m)	121-150 ft. (36.7-45.7 m)		
	PP	2 Inch	PDV	4-9 ft. (1.2-2.7m)	10-21 ft. (2.8-6.4 m)	22-39 ft. (6.5-11.9 m)	40-50 ft. (12.0-15.2 m)	
			PV	4-12 ft. (1.2-3.7 m)	13-30 ft. (3.8-9.1 m)	31-50 ft. (9.2-15.2 m)		
		3 Inch	PDV	4-25 ft. (1.2-7.6 m)	26-70 ft. (7.7-21.3 m)	71-150 ft. (21.4-45.7 m)		
			PV	4-35 ft. (1.2-10.7 m)	36-120 ft. (10.8-36.6 m)	121-150 ft. (36.7-45.7 m)		

(PVC = Polyvinyl Chloride, PP = Polypropylene, PDV = Power Direct Vent, PV= Power Vent)

OPERATION



OPERATION

Cascade System Configuration









Table 13: C Mode Cascade System (C13 & C14)

Code	Description	Setting	Configuration Options
C13	Number of Child Units in Cascade System	0:	No Cascade System (default).
		1-11:	Identify number of Child Units. This activates the Cascade System.
C14	Cascade System Heater ID Number	1:	Parent Heater (default).
		2-12:	Individually set each Child Unit per user preference.

Unit Conversion Mode

Units of measure can be changed from Imperial to Metric and vice versa. For example, temperature can be changed from °F to °C. Flow rate will also change from gallons per minute to liters per minute when this setting is changed. Follow this procedure to change this setting:

Table 14: Convert Units

	Operation	Screen on the Controller (Built-in & Remote)
1.	Turn on the 120 VAC power supply to the unit.	
2.	Press the "ON/OFF" button on the controller in order to turn the controller on.	
3.	The set point temperature will display as shown in the picture on the right (Example: 120°F).	
4.	Press and hold the "SETTING" button for 5 seconds to access the water heater Adjustment Mode (A Mode).	LONG PRESS 
5.	The display will flash between code "A00" and the current set temperature. Press the "UP" or "DOWN" button once and the display will show code "A01." Short press the "SETTING" button to show the current temperature setting. The temperature will flash.	SHORT PRESS 
6.	Press the "UP" button and the "DOWN" button to alternate between Fahrenheit and Celsius.	 
7.	Short press the "SETTING" button again to execute the change.	SHORT PRESS 
8.	Long press the "SETTING" to return the display to normal operation. The new temperature set point will appear in the selected unit (Example: 49°C).	

OPERATION

Information Mode (P Mode)

Follow the procedure below to access P Mode:

1. Press and hold the "UP" button and the "DOWN" button for 5 seconds to access P Mode.
2. Press the "UP" button or the "DOWN" button to search for the desired P Code.
3. Press and hold the "UP" button and the "DOWN" button for 5 seconds to return the display to normal operation.

Table 15: P Mode Settings (P00 - P23)

Code	Description	Value
P00	Heat Exchanger Water Outlet Temperature	°F / °C
P01	Water Outlet Temperature	°F / °C
P02	Water Inlet Temperature	°F / °C
P03	Water Flow	0.1* gpm OR 0.1* L/min
P04	Fan Speed	The real-time Fan speed (RPM)
P05	Fan Current	(mA)
P06	Proportional Valve Current	(mA)
P07	Bypass Water Valve Position	The real-time position of bypass valve (0 = full open; 2200 = full closed)
P08	Main Water Valve Position	The real-time position of main water valve (0 = full open; 2200 = full closed)
P09	A/D Value Of Flame	Flame sensor signal: <ul style="list-style-type: none"> • Less than 140 in standby • Greater than 180 under combustion (this value increases as input increases)
P12	Most Recent Fault Code	Fault code
P13	Second Most Recent Fault Code	
P14	Third Most Recent Fault Code	
P15	Exhaust Temperature	°F / °C
P16	Display Software Version No.	Front board software version
P17	Controller Software Version No.	Main board software version
P19	Model Number	199/180/160/140
P20	Combustion Time	Combustion time in hours. The UIM will display up to 4 digits (2 second pause) and the remaining 4 digits. See Figure 4.
P21	Ignition Quantity	Number of times the ignitor has activated. The UIM will display up to 4 digits (2 second pause) and the remaining 4 digits. See Figure 4.

OPERATION



EXAMPLE:

Join the two values (not add) to create the total: 231,971 then x 100 will yield 23,197,100 gallons.

Figure 4 - Combining multiple display value data. Both 8 and 5 units.



MAINTENANCE

Descaling

During operation, a tankless water heater (supplied with hard water) accumulates hard water deposits on the interior surfaces of the heat exchanger. These deposits make it difficult to transfer heat into the water, lowering the water heater's efficiency and causing excessive wear to the components. Removing any deposits is essential to the proper operation and longevity of the water heater. The X3 model should not require descaling, however, if you choose to descale the water heater **you must use the Bypass cartridge**. A Bypass cartridge can be ordered from the manufacturer, p/n: 100374700.

NOTICE: DO NOT descale the water heater using the X3 cartridge as this may damage the cartridge media. See page 21 for instructions on how to remove the X3 and install the Bypass.

The water heater has a descaling mode that will do the following to help descale the water heater:

- Locks out the heater firing operation so the heater remains in standby mode
- The flow control valve will stay in the fully open position
- The bypass water valve will move to the fully closed position to force the descaling solution through the heat exchanger.
- The freeze protection system will not be activated.

Tools and Materials:

- Submersible transfer pump
- 3 gallons of 5% acidity white vinegar (food grade), available from most grocery stores
- Washing machine hoses (2x)
- 5 gallon bucket
- Water heater isolation valve kits, installed on both the cold water inlet and hot water outlet of the water heater X3 Bypass Cartridge (see Figure 6).

Descaling Procedure:

- 1 Close the isolation valves (C & D) to stop the main inlet and outlet flow of water to the house (see Figure 6).
- 2 Pour the white vinegar (3 gallons) into the 5 gallon bucket (see Figure 7).
- 3 Connect inlet hose to the transfer pump's discharge outlet. Connect the opposite end of hose to the inlet hose connection at the cold water inlet's isolation valve (see Figure 7).
- 4 Place the pump in the bucket of vinegar.
- 5 Connect the second hose to the outlet hose connection at the hot water outlet. Place the loose end of hose into the bucket with the vinegar (see Figure 7).
- 6 Open the hot and cold service valves A & B (see Figure 7).
- 7 Activate the water heater's descaling mode by accessing C Mode.
 - A. Simultaneously press and hold the **UP** arrow and the **SETTING** button for approximately 6 seconds.
 - B. The display will flash **C00**.
 - C. Press the **UP** button or **DOWN** button to cycle to **C15**.
 - D. Press the **SETTING** button (the display will flash OFF).
 - E. Press the **UP** button or **DOWN** button to cycle to "dScI" (see Figure 5).
 - F. Press the **SETTING** button to activate the descaling mode.



Figure 5 - UIM display

- 8 Turn power to the pump on and let it run for approximately 45 minutes.
 - 9 Shut OFF power to the pump when descaling is complete.
 - 10 Close service valves A & B (see Figure 7).
 - 11 If possible, connect the outlet hose to a drain or outside in order to flush the water heater. If unable, go to **Step 13**.
 - 12 Open valve A to flush the water heater and remove loose scale and vinegar. Suggested flush time is approximately 10 minutes. Proceed to **Step 15**.
 - 13 If unable to relocate the outlet hose to a drain or outside, confirm valves A & B are closed.
 - 14 Open valves C & D.
 - 15 Open the nearest hot water fixture to flush the water heater of any remaining vinegar. Suggested flush time is approximately 10 minutes.
- NOTICE: DO NOT** use a combined hot and cold fixture typically found in a shower.
- 16 When flushing is complete, close all valves and remove all hoses.
 - 17 Press the **SETTING** button on the water heater's controller.
 - 18 Use the **UP** button or **DOWN** button to change the display from "dScI" to "OFF."
 - 19 Press the **SETTING** button on the water heater's controller.
 - 20 Simultaneously press and hold the **UP** button and **SETTING** button for approximately 6 seconds to enter normal operating mode.
 - 21 Turn ON the gas supply valve.
 - 22 Open valves C & D.
 - 23 Open the nearest hot water fixture for a short time to test-fire the heater and confirm there are no issues.

MAINTENANCE

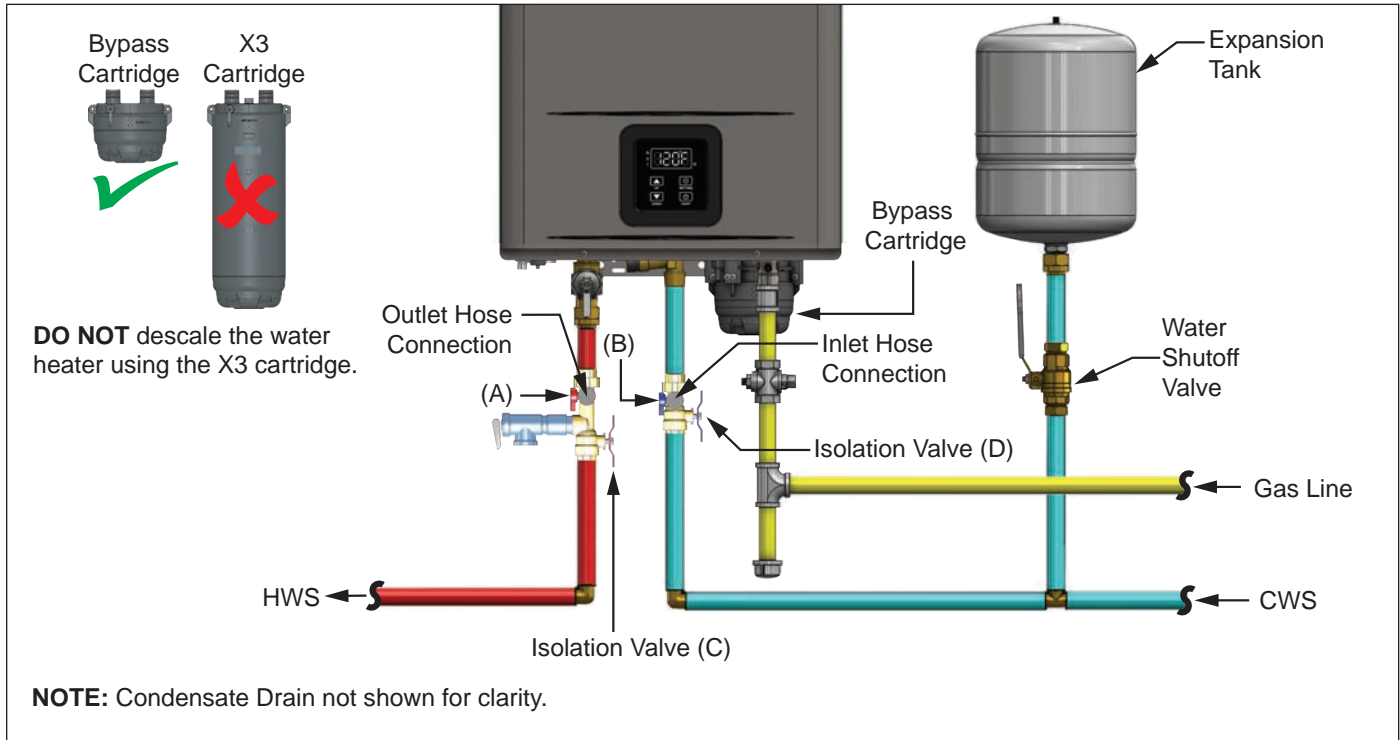

Figure 6 - Descaling the water heater

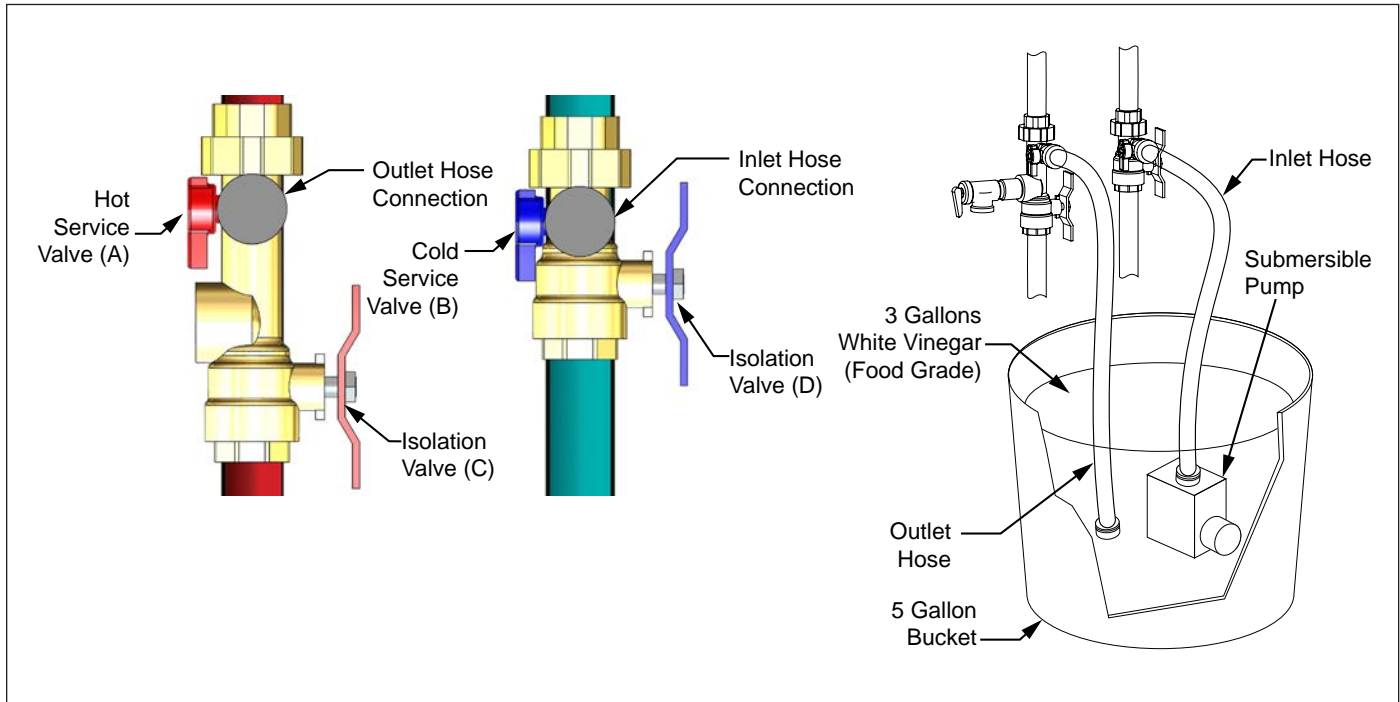

Figure 7 - Isolation valve connection points

MAINTENANCE



MAINTENANCE

Unit Draining & Power Outage (Freeze Protection)

Close the manual gas shut-off valve.

- 1 Disconnect power to the water heater by unplugging it or by turning off the circuit at the breaker box.
- 2 Close the cold inlet water valve.
- 3 Open all hot water taps in the house. When the residual water flow has ceased, close all hot water taps.
- 4 Drain the X3® (or Bypass) Cartridge: Have a bucket or pan to catch water from the X3® Cartridge. To remove the X3® Cartridge, remove and keep the 3 screws securing the cartridge in place. Pull down to remove it from the water heater. Empty the water out of the cartridge into the bucket.
- 5 Wait a few minutes to ensure all water has completely drained from the unit.
- 6 Keep the cold water valve closed. Keep the gas valve closed. Keep supply power disconnected.
- 7 To restore the unit to operation, reinstall the X3® Cartridge with 3 screws removed earlier. For detailed instructions see the “X3® & Bypass Cartridge” section on page 21.
- 8 Open the cold inlet water valve. Check all water connections for leaks. If leaks are found, shut off the cold water inlet valve and immediately fix any leaks. If no leaks are present proceed to the next step.

- 9 Reconnect power to the water heater.
- 10 Open the manual gas shut-off to the water heater.
- 11 If the set temperature is not displayed, press the **ON/OFF** button.

NOTICE: If any errors occur, shut off the water immediately.

Discharge Condensate

- 1 Inspect the drain lines for any clogs and clear.
- 2 Check the drain lines for a downward slope. Correct any lines where water does not drain freely.
- 3 Inspect the built-in condensate trap drain lines for debris. Disconnect the lines and drain to remove the debris.
- 4 If a neutralizer is installed, check the pH level. Replace the neutralizer if the pH of the outlet water is below 6.0.
- 5 If this filter is clogged, water will not be supplied to the water heater properly.

Inlet Water Filter

- 1 Close the manual gas shut-off valve.
- 2 Disconnect power to the water heater by unplugging it or by turning off the circuit at the breaker box.
- 3 Close the inlet water valve.
- 4 Open all hot water taps in the house. When the residual water flow has ceased, close all hot water taps.

- 5 Drain the X3® (or Bypass) Cartridge: Have a bucket or pan to catch water from the X3® Cartridge. To remove the X3® Cartridge, remove and keep the 3 screws securing the cartridge in place. Pull down to remove it from the water heater. Empty the water out of the cartridge into the bucket.
- 6 Wait a few minutes to ensure all water has completely drained from the unit.
- 7 Unscrew the inlet water filter and remove it from the water heater.
- 8 Clean the filter: Check the water filter located within the cold inlet. With a tiny brush, clean the water filter of any debris which may have accumulated.
- 9 Screw the inlet water filter back into place. Hand-tighten only.

NOTICE: Handle with care and verify the O-ring is not dirty or damaged.

- 10 To restore the unit to operation, reinstall the X3® Cartridge with 3 screws removed earlier. For detailed instructions see the “X3® & Bypass Cartridge” section on page 21.
- 11 Turn **ON** the cold water supply to the water heater at the cold inlet valve. The system will fully pressurize and any leaks at water connections will be apparent. Correct any leaks immediately.
- 12 Turn **ON** the gas supply to the water heater at the manual gas shut off valve.
- 13 Restore power to the water heater. The water heater is now ready for operation.

MAINTENANCE

X3® & Bypass Cartridge

Removing the Old Cartridge

- 1 Disconnect power to the water heater by unplugging it or by turning off the circuit at the breaker box, as appropriate. The power button on the water heater and remote **DOES NOT** disconnect power to the water heater. You must physically disconnect power to the water heater.
- 2 Shut **OFF** the cold water supply to the water heater at the cold inlet valve.
- 3 Open all hot water fixtures in the house. When the residual water flow has ceased, close all hot water fixtures. This will depressurize the water heater.
- 4 Locate the three screws securing the X3®/Bypass cartridge. Remove the (A) M4-12mm screw and the two (B) M4-25mm screws from cartridge. Place screws aside in a safe place for reinstallation. See Figure 8 and Figure 9.

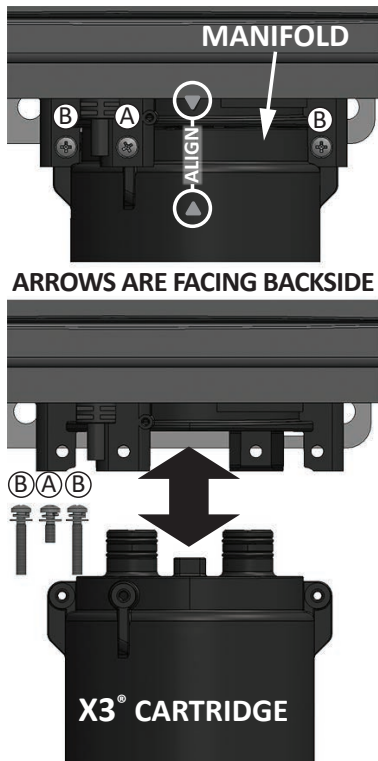

Figure 8 - X3® Cartridge

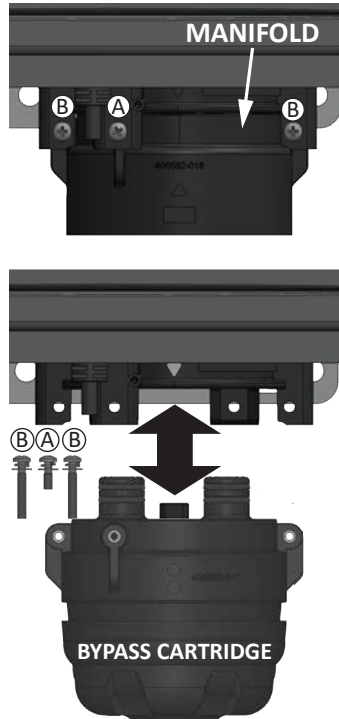

Figure 9 - Bypass Cartridge

NOTICE: If you have the cartridge anti-freeze kit installed, remove and set it aside for reinstallation later.

- 5 With the screws removed, pull down to remove the cartridge from the water heater. Place a bucket under the water heater cabinet to collect any residual water.

NOTICE: The cartridge will be full of water. Use caution not to tilt the cartridge until the water has been drained.

Installing the New Cartridge:

- 6 Inspect the new cartridge and O-rings for damage or debris. Verify lubricant has been properly applied to O-rings.
- 7 Insert the cartridge into manifold.

NOTICE: The X3® cartridge is keyed to only install in one direction. Align the ▲ on the cartridge with the ▼ on the manifold (arrows will be back facing for TM series heaters). When inserting the cartridge, push up until the screw holes align. Some resistance is normal. The bypass cartridge is not keyed and will install in either direction. Figure 8 and Figure 9.

- 8 Insert and snug all three screws by hand. Use a screwdriver to tighten the two (B) screws first and lastly tighten screw (A). **DO NOT** use a drill or impact driver to tighten the screws.
- NOTICE:** Use only the screws removed earlier and note their order. They are not interchangeable with any other type of screw.
- 9 Turn **ON** the cold water supply to the water heater at the cold inlet valve. The system will fully pressurize and any leaks at water connections will be apparent. Correct any leaks immediately.
- 10 Restore power to the water heater. The water heater is now ready for operation.

TROUBLESHOOTING

General Troubleshooting

If the water heater is experiencing issues, please check the following.

Table 16: Troubleshooting Chart

	Problem	Solutions
TROUBLESHOOTING Temperature and Amount of Hot Water	It takes a long time to get hot water at the fixtures.	<ul style="list-style-type: none"> • The times it takes to deliver hot water from the water heater to your fixtures depends on the length of piping between the two. The longer the distance or the bigger the pipes, the longer it will take to get hot water. • If you would like to receive hot water to your fixtures more quickly, you may want to consider a hot water recirculation system.
	The water is not hot enough.	<ul style="list-style-type: none"> • Check the set temperature of the water heater and adjust, if necessary. • Check cross plumbing between the cold water lines and hot water lines. • Is the gas supply valve open fully? • Is the gas line sized properly? • Is the gas supply pressure sufficient? • Check if the Point-of-Use mixing valves are set correctly if they are installed.
	The water is too hot.	<ul style="list-style-type: none"> • Is the set point temperature set too high?
	The hot water is not available when a fixture is opened.	<ul style="list-style-type: none"> • Make sure the unit has 120 VAC, 60 Hz power supply and power frequency is set to 60 hz. • Verify the operation setting is ON by viewing the UIM. If the set temperature is showing, or you press the UP arrow to display the set temperature, then the operation setting is ON. If the display is blank and nothing appears when pressing the UP button, then the operation state is set to OFF. Press the ON/OFF button to activate the heater. The set temperature will display when set to ON. • Is the gas supply valve open fully and within the allowable gas pressure range? • Is the water supply valve fully open? • Is the filter on the cold water inlet clean? • Is the hot water fixture sufficiently open to draw at least 0.4 GPM (1.5 L/min) through the water heater? • Is the unit frozen?
	The hot water runs cold and stays cold.	<ul style="list-style-type: none"> • Is the flow rate enough to keep the water heater running? • If there is a recirculation system installed, does the recirculation line have enough check valves? • Is the gas supply valve fully open? • Is the filter on the cold water inlet clean? • Are the fixtures clean of debris and obstructions?
	Fluctuation in hot water temperature.	<ul style="list-style-type: none"> • Is the filter on the cold water inlet clean? • Is the gas line sized properly? • Is the gas supply pressure sufficient? • Check for cross connection between cold water lines and hot water lines. • If cascaded with multiple heaters, inspect and verify each heater is operating properly within the cascade system.



TROUBLESHOOTING

Table 16: Troubleshooting Chart

	Problem	Solutions
Water Heater	Unit does not ignite when water goes through the unit.	<ul style="list-style-type: none"> • Is the flow rate over 0.4 GPM (1.5 L/min)? • Check the filter on the cold water inlet. • Check for reverse connections and cross connection. • If you use the remote controller and/or built-in controller, is the power button turned on? • Check if the inlet water temperature is too high. If it is too close to the set temperature, the water heater will not activate.
	The fan motor is still spinning after operation has stopped.	<ul style="list-style-type: none"> • This is normal. After operation has stopped, the fan motor keeps running to re-ignite quickly, as well as to purge all the exhaust gas out of the flue.
	Unit sounds abnormal while in operation.	<ul style="list-style-type: none"> • Check all venting and terminations for any blockage and clear. • If other exhaust terminations are nearby, confirm flue gases are not sucked into the water heater's air intake.



TROUBLESHOOTING

Error Codes

The water heater has self-diagnostic functions for safety and convenience when troubleshooting.

If there is a problem with the installation or the unit, the error code associated with that failure will be displayed on the built-in controller or remote controller.

Consult Table 17 on the following pages for the description of each error code.

Single Unit Installation (Example)

If your water heater has the "E002" error code (which signifies a high limit break):

- Indicator on the built-in and/or remote controller will display "E002" on the screen.

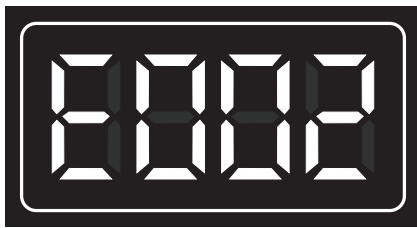

Figure 10 - Single Unit Error Code Example

Cascade System (Example)

Error codes will be displayed differently with units installed within a Cascade System, not only to show what the error code is, but to also indicate which unit within the system has the error code. Below is a sample of how the error code "E002" is displayed in a Cascade System.

If Unit #2 has the "E002" error code (which signifies a high limit break):

- Indicator on the built-in and/or remote controller of Parent unit will intermittently flash "E002" and "2."

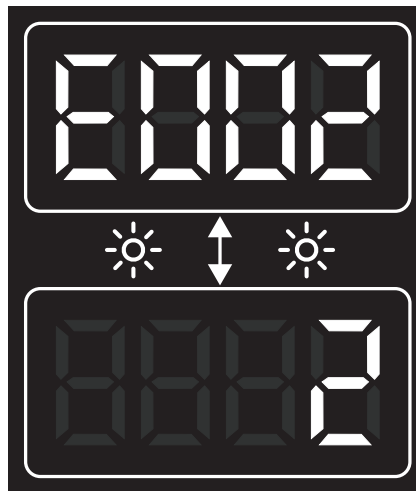

Figure 11 - Cascade System Error Code Example (Parent Unit)

- Child unit #2 will intermittently flash "E002" on the display.



Figure 12 - Cascade System Error Code Example (Child Unit)

- Child unit #3 & #4 will not display anything, as the error code does not pertain to them.

TROUBLESHOOTING

Fault Analysis of Error Codes

If the water heater is displaying an error code, please check the following.

Table 17: Error Code Fault Analysis

Error Code	Error Description	Procedure
E002	High Limit Break	<ol style="list-style-type: none">1. Visual inspection: connection/breakage of wires. Possibility also includes scale deposits inside the heat exchanger if using an M model.2. Manual Hi-Limit Switch on water outlet tripped. Check the switch for proper operation. Press the reset button (center of the switch), to reset it. NOTICE: You will hear and feel the switch click when resetting it. If the hi-limit switch continues to trip replace the hi-limit switch.3. M Model: If water heater is installed in a hard water area the manual hi-limit switch may trip due to scaling.
E006	PCB Hardware Fault - AD Converter Fault	Check PCB wiring for loose, damaged or cut wires/connectors. Correct any loose connection and replace any damaged wires/connectors. If all wires/connectors are intact, replace the PCB.
E010	Frequency Fault	<ol style="list-style-type: none">1. PCB has detected an incorrect power supply frequency. Note the default frequency is 60 Hz. Confirm that C07 is set to the correct frequency of the supply power. See Table 6 to access modes.<ul style="list-style-type: none">• if C07 = 60 ($48 < X < 72$)• if C07 = 50 ($40 < X < 60$)2. If the setting is correct and the error still occurs, check supply to confirm frequency range.
E011	PCB Hardware Fault - Memory Error	<p>The water heater will continue to operate while this error code is flashing. If this heater is part of a cascade system, then the system will be affected based on the heater's setting. PCB must be replaced on impacted heater.</p> <ul style="list-style-type: none">• Parent Heater: The cascade system will not operate. Remove this heater from the cascade system and set a different heater as the Parent.• Child Heater: This heater will not operate. The rest of the cascade system will continue to run.



TROUBLESHOOTING

Table 17: Error Code Fault Analysis

Error Code	Error Description	Procedure
E036	Flame Failure	<p>WARNING! Working on an energized circuit can result in severe injury or death from electrical shock.</p> <ol style="list-style-type: none"> Verify that the gas supply pressure is within specifications when the heater is in standby, and verify the gas pressure does not drop below the minimum specified supply pressure when all gas appliances are in operation. Also, verify that the gas line is cleared of debris. <ul style="list-style-type: none"> It is possible that there is a faulty pressure regulator at the gas meter. If a second stage regulator is installed, verify the following: that it is sized properly for the application; that it is installed per the manufacturer's instruction (pay close attention if an indoor vent limiter is installed); the vent line (if installed) is sized properly. NOTICE: Some manufacturers may recommend that a specific amount of straight pipe is installed on the regulator outlet before any changes in direction. Refer to the regulator's manufacturer. Check for blockages in venting, such as bird nests, animals, or trash. A blockage will cause improper operation leading to reduced capacity and inability to maintain combustion. If flame ignites for only 1-2 seconds before going out, verify that the red "Flame Detected" flame indicator on the built-in controller or remote controller did not turn on. If the flame indicator stayed off, then inspect the flame sensor. Clean it if necessary. Replace it if any damage is seen.
E037	False Flame Detection (During Standby)	<p>WARNING! Working on an energized circuit can result in severe injury or death from electrical shock.</p> <ol style="list-style-type: none"> Verify the gas supply pressure is not above the specified maximum pressure. If it is, troubleshoot and correct the gas supply system. Check the error code history, P modes P12, P13, P14 and document the codes. <ul style="list-style-type: none"> If E384 is in the list, replace the gas valve. If E412 or E414 appear, replace the PCB. If E413 or E417 appear, inspect the flame sensor rod for dirt, debris, or damage. Clean or replace the flame sensor. If either code appears again, replace the PCB. NOTICE: You must run water through the heater for a minimum of 3 minutes at a minimum of 1 GPM to check for E417.



TROUBLESHOOTING

Table 17: Error Code Fault Analysis

Error Code	Error Description	Procedure
E038	Ignition Failure	<p>WARNING! Working on an energized circuit can result in severe injury or death from electrical shock.</p> <ol style="list-style-type: none"> Verify that the gas supply pressure is within specifications when the heater is in standby, and verify the gas pressure does not drop below the minimum specified supply pressure when all gas appliances are in operation. Also, verify that the gas line is cleared of debris. For Propane installations, verify the propane tank level is not too low. <ul style="list-style-type: none"> It is possible that there is a faulty pressure regulator at the gas meter. If a second stage regulator is installed, verify the following: that it is sized properly for the application; that it is installed per the manufacturer's instruction (pay close attention if an indoor vent limiter is installed); the vent line (if installed) is sized properly. NOTICE: Some manufacturers may recommend that a specific amount of straight pipe is installed on the regulator outlet before any changes in direction. Refer to the regulator's manufacturer. Check for blockages in venting, such as bird nests, animals, or trash. A blockage will cause improper operation leading to reduced capacity and inability to maintain combustion. If flame ignites for only 1-2 seconds before going out, verify that the red "Flame Detected" flame indicator on the built-in controller or remote controller did not turn on. If the flame indicator stayed off, then inspect the flame sensor. Clean it if necessary. Replace it if any damage is seen.
E041	Outlet Water Over-temp	<ol style="list-style-type: none"> Verify the thermistor reading with the water outlet temperature. See "Thermistor Resistance Vs Temperature Charts" on page 121. Remove the outlet thermistor (do not lose the O-ring) and check for any dirt or debris. Clean with an Emery cloth. If the thermistor is damaged, replace it. Check all venting for any blockage and clear. Verify gas pressure and supply and if failure persists replace gas valve.
E049	Exhaust Thermistor Failure	<ol style="list-style-type: none"> Remove the thermistor (do not lose the O-ring) and check for any dirt or debris. Clean with an Emery cloth. If the thermistor is damaged, replace it. Check the Thermistor sensor wire for a short or disconnection. Correct any loose connections and replace any damaged wire/connector or thermistor assembly. Check all venting (intake/exhaust) for an blockages and clear as necessary. Verify gas pressure and supply. If failure persists, replace gas valve.
E050	Inlet Thermistor Failure	<ol style="list-style-type: none"> Remove the thermistor (do not lose the O-ring) and check for any dirt or debris. Clean with an Emery cloth. If the thermistor is damaged, replace it. Check the Thermistor sensor wire for a short or disconnection. Correct any loose connection and replace any damaged wire/connector.

TROUBLESHOOTING



TROUBLESHOOTING

Table 17: Error Code Fault Analysis

Error Code	Error Description	Procedure
E051	Outlet Thermistor Failure	<ol style="list-style-type: none"> 1. Remove the thermistor (do not lose the O-ring) and check for any dirt or debris. Clean with an Emory cloth. If the thermistor is damaged, replace it. 2. Check the Thermistor sensor wire for a short or disconnection. Correct any loose connection and replace any damaged wire/connector. If the error still occurs, contact a qualified service technician.
E052	Heat Exchanger Thermistor Failure	<ol style="list-style-type: none"> 1. Remove the thermistor (do not lose the O-ring) and check for any dirt or debris. Clean with an Emory cloth. If the thermistor is damaged, replace it. 2. Check the Thermistor sensor wire for a short or disconnection. Correct any loose connection and replace any damaged wire/connector. 3. Check all venting (intake/exhaust) for an blockages and clear as necessary. Verify gas pressure and supply and if failure persists replace gas valve.
E381	Combustion Blockage	<ol style="list-style-type: none"> 1. With the water heater power disconnected, check the exhaust vent and air intake piping for any blockages. Remove any blockages. 2. Verify the water heater has sufficient combustion air. Reference the Combustion and Venting Installation section of the manual. 3. If the error still occurs, contact a qualified service technician.
E382	Abnormal Proportional Valve Current	Check the proportional valve wiring. Correct any loose connection and replace any damaged wire/connector. If the error still occurs, contact a qualified service technician.
E383	Inlet Water Over-temp	<ol style="list-style-type: none"> 1. Verify the inlet water temperature is not above the water heater's set temperature. 2. Remove the thermistor (do not lose the O-ring) and check for any dirt or debris. Clean with an Emory cloth. If the thermistor is damaged, replace it. 3. Check the Thermistor sensor wire for a short or disconnection. Correct any loose connection and replace any damaged wire/connector. If the error persists, replace thermistor.
E385	Main Gas Solenoid Valve Drive Circuit Failure	The PCB detects an incorrect voltage from the gas valve solenoid valve. Correct any loose connections and replace any damaged wire/connector.
E388	Bypass Valve Fault	<ol style="list-style-type: none"> 1. Correct any loose connection and replace any damaged wire/connector. 2. Follow the draining procedure in the installation manual to properly drain the water heater. Remove the Bypass valve and inspect for any debris or damage. Replace if needed.
E389	Fan Current AD Failure	Replace the PCB.
E390	Fan Over Max Current (During Standby)	Check the fan motor wiring. Correct any loose connection and replace any damaged wire/connector. If the error still occurs, contact a qualified service technician.
E391	Fan Over Max Current (During Operation)	Check the fan motor wiring. Correct any loose connection and replace any damaged wire/connector. If the error still occurs, contact a qualified service technician.



TROUBLESHOOTING

Table 17: Error Code Fault Analysis

Error Code	Error Description	Procedure
E392	Fan False Start (During Operation)	Check the fan motor wiring. Correct any loose connection and replace any damaged wire/connector.
E393	Fan Signal Loss	Check the fan motor wiring. Correct any loose connection and replace any damaged wire/connector.
E394	Fan Target Speed	<ol style="list-style-type: none"> 1. Check the fan motor wiring. Correct any loose connection and replace any damaged wire/connector. 2. With the water heater power disconnected, check the exhaust vent and air intake piping for any blockages. Remove any blockages.
E395	Fan Current without Drive (During Standby)	Check the fan motor wiring. Correct any loose connection and replace any damaged wire/connector. If the error still occurs, contact a qualified service technician.
E400	Communication Fault with UIM	<ol style="list-style-type: none"> 1. Check the UIM wiring. Correct any loose connection and replace any damaged wire/connector. 2. If UIM is displaying, replace the PCB. If UIM is not displaying, replace the UIM.
E401	Communication Fault with Remote Controller	<ol style="list-style-type: none"> 1. Check the Remote Controller wiring. Correct any loose connections and replace any damaged wire/connector. 2. Only one remote controller can be installed. Remove any additional remote controllers. 3. If the error still occurs and remote is displaying values, then replace the PCB.
E402	Communication Fault in Cascade System	<ol style="list-style-type: none"> 1. Check the Cascade wiring. Correct any loose connections and replace any damaged wire/connector. 2. Cycle the child heater's power OFF/ON if the cascade wiring was disconnected while the system still had power. 3. If the error still persists, verify parent heater PCB functionality. Replace PCB if necessary.
E404	Inconsistent Models in Cascade-Link	Confirm all units in Cascade System are the same model. All models in the cascade system must be the same.
E412	PCB Hardware Fault - Flame Circuit Failure	Replace the PCB.

TROUBLESHOOTING



TROUBLESHOOTING

Table 17: Error Code Fault Analysis

Error Code	Error Description	Procedure
E413	Flame Sensor Fault	<ol style="list-style-type: none"> 1. Verify the water heater is properly grounded? 2. Check the flame sensor wire for a short or disconnection. Correct any loose connections and replace any damaged wire/connector. 3. With the water heater power disconnected, check the exhaust vent and air intake piping for any blockages. Remove any blockages. 4. Verify the water heater has sufficient combustion air, reference the Combustion and Venting Installation section in the installation manual. 5. Check the installation area for corrosive elements, reference the see Installation Environment section in the installation manual. 6. Remove and inspect the flame sensor, check for any dirt or debris. Clean with Emery cloth. If error persists, replace flame sensor.
E414	PCB - Flame Sensor Circuit	<ol style="list-style-type: none"> 1. Check the flame sensor wire for a short or disconnection. Correct any loose connection and replace any damaged wire/connector. 2. If the error still occurs, replace the PCB.
E416	Analog/Digital (AD) Value Fault	<ol style="list-style-type: none"> 1. Check the outlet thermistor sensor wire for a short or disconnection. Correct any loose connections and replace any damaged wire/connector. 2. Remove the outlet thermistor (do not lose the O-ring) and check for any dirt or debris. Clean with an Emery cloth. If the thermistor is damaged, replace it. 3. If the error still occurs, replace the PCB.
E418	Exhaust High Temperature	<ol style="list-style-type: none"> 1. With the water heater power disconnected, check the exhaust vent and air intake piping for any blockages. Remove any blockages. 2. Remove the exhaust thermistor (do not lose the O-ring) and check for any dirt or debris. Clean with Emory cloth. If the thermistor is damaged, replace it. 3. Check all venting (intake/exhaust) for an blockages and clear as necessary. Verify gas pressure and supply. If failure persists, replace gas valve.
E419	Flame Signal Lost	<ol style="list-style-type: none"> 1. Check the flame sensor wire for a short or disconnection. Correct any loose connection and replace any damaged wire/connector. 2. With the water heater power disconnected, check the exhaust vent and air intake piping for any blockages. Remove any blockages. If the error still occurs, contact a qualified service technician. 3. If the error still occurs, contact a qualified service technician.



TROUBLESHOOTING

Table 17: Error Code Fault Analysis

Error Code	Error Description	Procedure
E426	Condensate Drain Overflow	<ol style="list-style-type: none"> 1. Place a bucket under the water heater to catch any water. 2. With the water heater off, check the condensate drain for any blockages. Remove any blockages. 3. Check the condensate drain wires for a short or disconnection. Correct any loose connection and replace any damaged wire/connector. 4. Verify the condensate drain line is installed correctly, reference the installation manual.
E427	Flow Control Valve	<ol style="list-style-type: none"> 1. Check the flow control valve wires for a short or disconnection. Correct any loose connections and replace any damaged wire/connector. 2. Drain the water heater following the Unit Draining & Power Outage section in the installation manual. 3. Remove the flow control valve and inspect for any debris or damage. Replace if needed.
E428	Flow Sensor - Cascade Only	<ol style="list-style-type: none"> 1. Verify the water heater's operation is enabled. The heater's UIM will display the set temperature when enabled. If it is disabled, press the heater's ON/OFF button to enable the heater's operation. 2. Verify that the heater's water shutoff valves are open. 3. Check the flow sensor wires for a short or disconnection. Correct any loose connections and replace any damaged wire/connector. 4. Drain the water heater following the Unit Draining & Power Outage section in the installation manual. 5. Remove the flow sensor and inspect for any debris or damage. Replace if needed. 6. Remove and clean the inlet water filter. Replace if needed.
E429	Flow Control Valve Fault - Cascade Only	<ol style="list-style-type: none"> 1. Check the flow control valve wires for a short or disconnection. Correct any loose connections and replace any damaged wire/connector. 2. Drain the water heater following the Unit Draining & Power Outage section in the installation manual. 3. Remove the flow control valve and inspect for any debris or damage. Replace if needed.



SERVICE (ELECTRONIC & WIRING COMPONENTS)

User Interface Module & Wire Harness

Kit 100390075 Contains:

- User Interface Module (UIM)
- Kit Instructions

Kit 100390076 Contains:

- UIM Wire Harness
- Kit Instructions

IMPORTANT: Use only factory authorized replacement parts. **DO NOT USE ELECTRIC SCREWDRIVERS OR DRILLS, HAND TIGHTEN ALL SCREWS TO PREVENT OVERTIGHTENING.** If you lack the necessary skills to properly perform the installation, you should not proceed, but get help from a qualified service technician.

Tools and Materials Required:

- Phillips Screwdriver
- Safety Gloves

Preparing Water Heater for Service

1 Disconnect power to the water heater by unplugging it or by turning off the circuit at the breaker box, as appropriate. The power button on the water heater and remote **DOES NOT** disconnect power to the water heater. You must physically disconnect power to the water heater.

Accessing Water Heater Components

2 Locate the two screws at the bottom of the cabinet cover. Use a Phillips screwdriver to remove the screws. Place screws aside in a safe place for reinstallation.

3 Lift cover up and away from cabinet to gain access to the water heater's internal components.

Replacing the User Interface Module (Kit 100390075)

4 Locate the User Interface Module (UIM). See Figure 13.

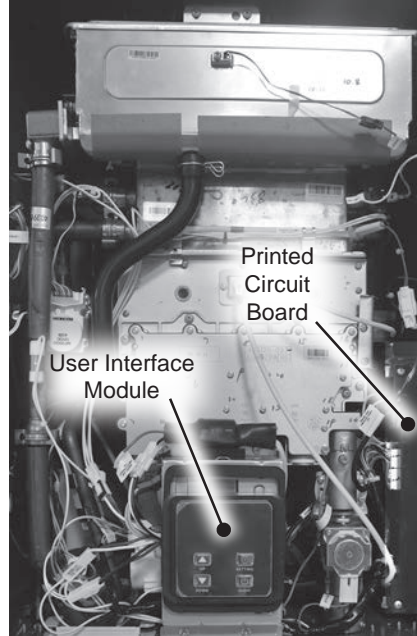

Figure 13 - Locating UIM

5 Gently lift UIM upward to release from bottom of bracket and remove UIM from bracket.

6 Disconnect wire harness from UIM. See Figure 14.

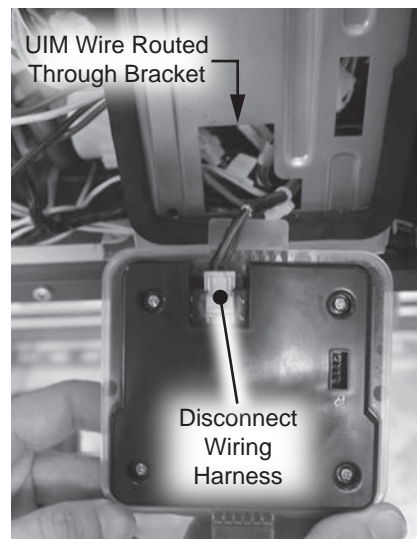

Figure 14 - Disconnecting UIM

7 If replacing the User Interface Module, dispose of it properly. Locate the new UIM provided in the kit and proceed to **Step 14**.

If replacing the UIM wire only, place UIM aside in a safe place for reinstallation and proceed to the next section.

Replacing the User Interface Module Wire (Kit 100390076)

8 Locate the Printed Circuit Board on the right side of the water heater. Use a Phillips screwdriver to remove the two screws securing the PCB. Place screws aside in a safe place for reinstallation. See Figure 15.

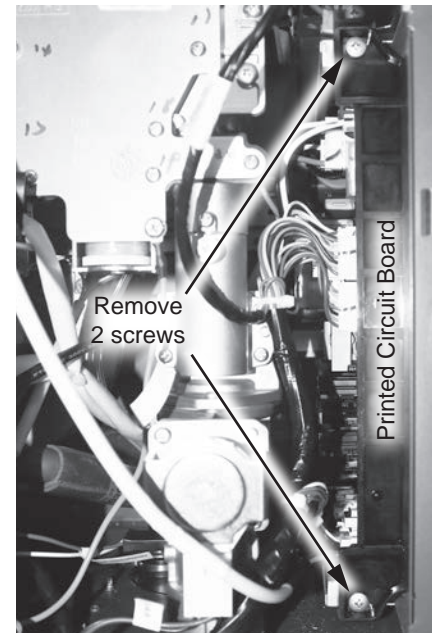

Figure 15 - Removing PCB screws

9 Gently slide PCB out from water heater.

10 Using Figure 16 as reference, disconnect the UIM wiring harness from PCB.

SERVICE (ELECTRONIC & WIRING COMPONENTS)

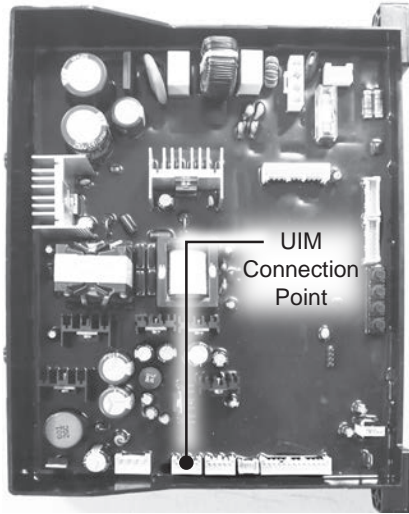

Figure 16 - Disconnecting UIM from PCB

- 11 Remove UIM wire harness from water heater. Take note of how wire harness is routed for easy installation of new wire harness.
- 12 Locate the new wire harness provided in the kit. Connect the wire harness to the PCB and route the wiring behind the gas valve and through the bottom opening of the UIM bracket. See Figure 14 for reference.
- 13 With the wiring harness secured, slide PCB back into position and secure PCB to mounting brackets with the two screws previously removed in **Step 8**.

Replacing the User Interface Module

- 14 Connect wire harness to UIM. Slide UIM upward into slot in bracket, then gently push downward to secure UIM to bracket.

Returning Water Heater to Operation

- 15 Replace the cabinet cover and secure with the screws previously removed in **Step 2**.
- 16 Restore power to the water heater. The water heater is now ready for operation.

SERVICE (ELECTRONIC & WIRING COMPONENTS)

Hi-Limit Switch (Manual Reset)

Kit 100390070 Contains:

- Hi-Limit Switch (Manual Reset)
- Kit Instructions

IMPORTANT: Use only factory authorized replacement parts. **DO NOT USE ELECTRIC SCREWDRIVERS OR DRILLS, HAND TIGHTEN ALL SCREWS TO PREVENT OVERTIGHTENING.** If you lack the necessary skills to properly perform the installation, you should not proceed, but get help from a qualified service technician.

Tools and Materials Required:

- Phillips Screwdriver
- Safety Gloves

Preparing Water Heater for Service

- 1 Disconnect power to the water heater by unplugging it or by turning off the circuit at the breaker box, as appropriate. The power button on the water heater and remote **DOES NOT** disconnect power to the water heater. You must physically disconnect power to the water heater.

Accessing Water Heater Components

- 2 Locate the two screws at the bottom of the cabinet cover. Use a Phillips screwdriver to remove the screws. Place screws aside in a safe place for reinstallation.
- 3 Lift cover up and away from cabinet to gain access to the water heater's internal components.

Removing Hi-Limit Switch

- 4 Locate the hi-limit switch on the heat exchanger (top right side of water heater). Disconnect the two wire leads (labeled HIGH LIMIT 1) from the hi-limit switch. See Figure 17.

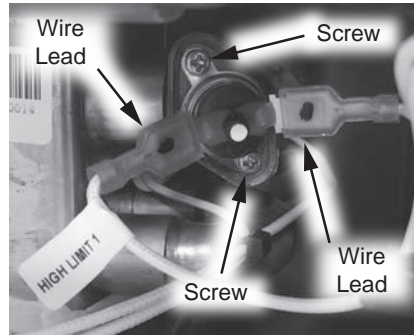

Figure 17 - Hi-Limit switch location

- 5 Use a Phillips screwdriver to remove the two screws securing the hi-limit switch to the heat exchanger. Place screws aside in a safe place for reinstallation. See Figure 17.
- 6 Remove hi-limit switch from heat exchanger and dispose of properly.

Installing New Hi-Limit Switch

- 7 Locate the new hi-limit switch assembly provided in the kit.
- 8 Install the hi-limit switch to the heat exchanger. Secure with the two screws previously removed in **Step 5**. Confirm hi-limit switch sits flush against heat exchanger.
- 9 Connect the two wire leads to the hi-limit switch previously disconnected in **Step 4**. Confirm wire connections are secure.

Returning the Water Heater to Operation

- 10 Replace the cabinet cover and secure with the screws previously removed in **Step 2**.
- 11 Restore power to the water heater. The water heater is now ready for operation.

SERVICE (ELECTRONIC & WIRING COMPONENTS)

Freeze Protection Thermostat

Kit 100390078 Contains:

- Freeze Protection Thermostat
- Kit Instructions

IMPORTANT: Use only factory authorized replacement parts. **DO NOT USE ELECTRIC SCREWDRIVERS OR DRILLS, HAND TIGHTEN ALL SCREWS TO PREVENT OVER TIGHTENING.** If you lack the necessary skills to properly perform the installation, you should not proceed, but get help from a qualified service technician.

Tools and Materials Required:

- Phillips Screwdriver
- Safety Gloves

Preparing Water Heater for Service

- 1 Disconnect power to the water heater by unplugging it or by turning off the circuit at the breaker box, as appropriate. The power button on the water heater and remote **DOES NOT** disconnect power to the water heater. You must physically disconnect power to the water heater.

Accessing Water Heater Components

- 2 Locate the two (2) screws at the bottom of the cabinet cover. Use a Phillips screwdriver to remove the screws. Place screws aside in a safe place for reinstallation.
- 3 Lift cover up and away from cabinet to gain access to the water heater's internal components.

Removing Freeze Protection Thermostat

- 4 Locate the freeze protection thermostat wiring harness as shown in Figure 18.
- 5 Remove the freeze protection thermostat from the outlet piping by gently pulling on metal clamp.

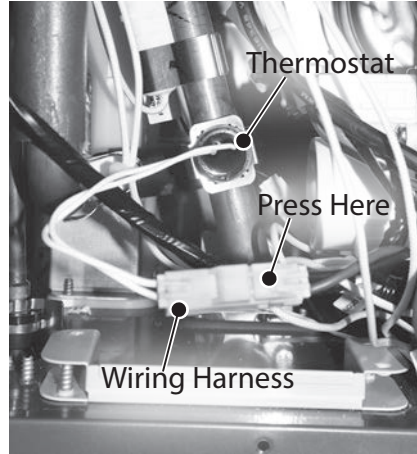

Figure 18 - Freeze protection thermostat location

- 6 Disconnect the freeze protection thermostat wiring harness. See Figure 18.

NOTICE: Press in the location shown in Figure 18 to disconnect the wiring harness.

- 7 Dispose of the old freeze protection thermostat properly.

Installing New Free Protection Thermostat

- 8 Locate the new freeze protection thermostat provided in the kit.
- 9 To install freeze protection thermostat to outlet water tube, gently push metal clamp onto tubing. The metal clamp will snap into place. Confirm thermostat sits flush against piping. See Figure 18.
- 10 Connect freeze protection thermostat to the wiring harness disconnected in **Step 6** See Figure 18.

Returning Water Heater to Operation

- 11 Replace the cabinet cover and secure with the screws previously removed in **Step 2**.
- 12 Restore power to the water heater. The water heater is now ready for operation.

SERVICE (ELECTRONIC & WIRING COMPONENTS)

Heater Block Upper Wiring Assembly

Kit 100390080 Contains:

- Heater Block Upper Wiring Assembly
- Kit Instructions

IMPORTANT: Use only factory authorized replacement parts. **DO NOT USE ELECTRIC SCREWDRIVERS OR DRILLS, HAND TIGHTEN ALL SCREWS TO PREVENT OVERTIGHTENING.** If you lack the necessary skills to properly perform the installation, you should not proceed, but get help from a qualified service technician.

Tools and Materials Required:

- Phillips Screwdriver
- Mini Pick
- Safety Gloves

Preparing Water Heater for Service

- 1 Disconnect power to the water heater by unplugging it or by turning off the circuit at the breaker box, as appropriate. The power button on the water heater and remote **DOES NOT** disconnect power to the water heater. You must physically disconnect power to the water heater.

Accessing Water Heater Components

- 2 Locate the two (2) screws at the bottom of the cabinet cover. Use a Phillips screwdriver to remove the screws. Place screws aside in a safe place for reinstallation.
- 3 Lift cover up and away from cabinet to gain access to the water heater's internal components.

Removing the Heater Block Upper Wiring Assembly

- 4 Locate the heater block upper wiring harness. Reference Figure 21 for location.
- 5 To disconnect, gently remove the security clip with a mini pick or fingernail. Push tab as shown in Figure 19. Separate the harnesses. Place security clip aside in a safe place for reinstallation.

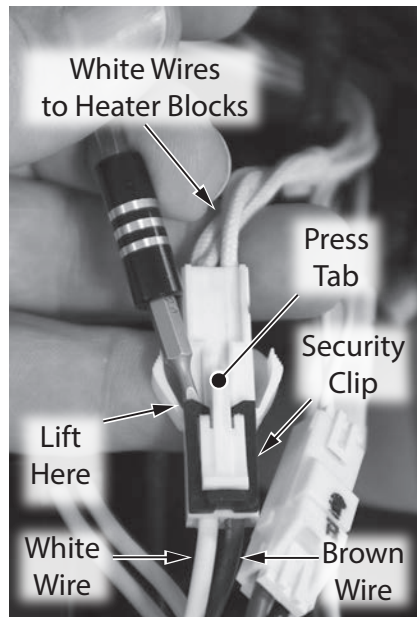

Figure 19 - Wiring security clip removal

- 6 Slide the heater cylinders A1 -A3 out from their flexible brackets. See Figure 21.
- 7 Remove the clip securing heater block A4. See Figure 21. Set the clip aside in a safe place for reinstallation.
- 8 Dispose of the old heater block upper wiring assembly properly.

Replacing the Heater Block Upper Wiring Assembly

- 9 Locate the new heater block upper wiring assembly

provided in the kit.

- 10 Install heater cylinders A1 - A2 as shown in Figure 21. The heater cylinders are held in place by flexible brackets.
- 11 Use a Phillips screwdriver to gently pry the flexible brackets away from the HEX to allow space for the heater cylinders and wires to slide out. Remove the two heater cylinders. See Figure 20.

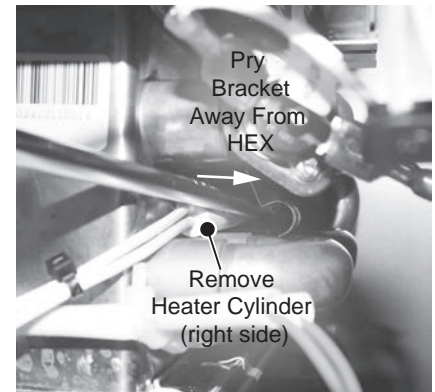

Figure 20 - Heater Cylinder replacement

- 12 Heater cylinder A-3 is held in place by a bracket with two flexible clips Reference Figure 3 for placement and orientation.
 - 13 Heater block A4 uses a compression style clip as shown in Figure 21.
 - 14 Reconnect the wiring harness and security clip removed in **Step 5**.
- ## Returning Water Heater to Operation
- 15 Replace the cabinet cover and secure with the screws previously removed in **Step 2**.
 - 16 Restore power to the water heater. The water heater is now ready for operation.

SERVICE (ELECTRONIC & WIRING COMPONENTS)

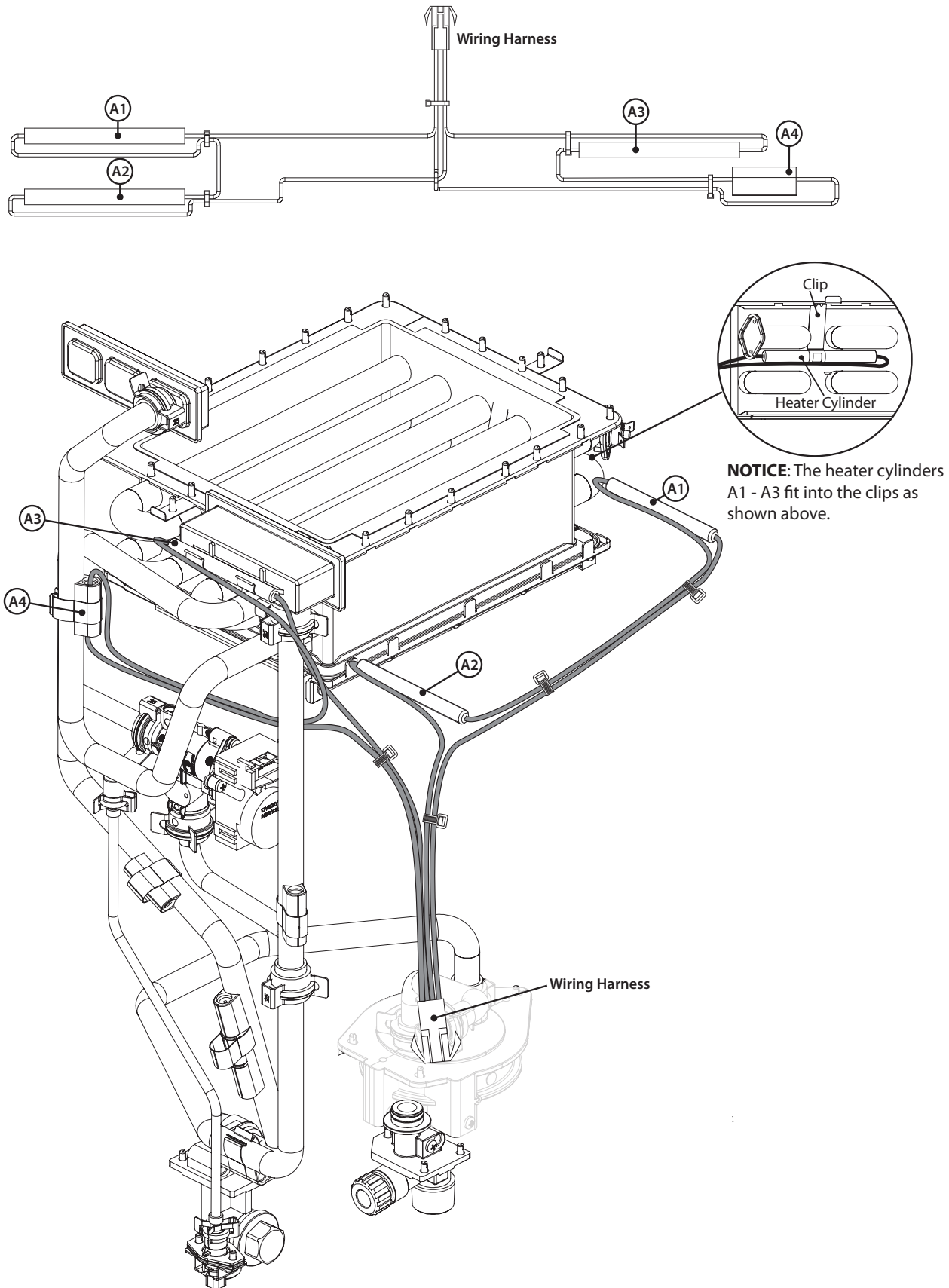

Figure 21 - Upper connection reference guide



SERVICE (ELECTRONIC & WIRING COMPONENTS)

Heater Block Lower Wiring Assembly

Kit 100390079 Contains:

- Heater Block Lower Wiring Assembly
- Kit Instructions

IMPORTANT: Use only factory authorized replacement parts. **DO NOT USE ELECTRIC SCREWDRIVERS OR DRILLS, HAND TIGHTEN ALL SCREWS TO PREVENT OVERTIGHTENING.** If you lack the necessary skills to properly perform the installation, you should not proceed, but get help from a qualified service technician.

Tools and Materials Required:

- Phillips Screwdriver
- Mini Pick
- Bucket or Pan
- Towel or Rag
- Safety Gloves

Preparing Water Heater for Service

- 1 Disconnect power to the water heater by unplugging it or by turning off the circuit at the breaker box, as appropriate. The power button on the water heater and remote **DOES NOT** disconnect power to the water heater. You must physically disconnect power to the water heater.
- 2 Shut **OFF** the cold water supply to the water heater at the cold inlet valve.
- 3 Open all hot water fixtures in the house. When the residual water flow has ceased, close all hot water fixtures. This will depressurize the water heater.

Draining the Water Heater

- 4 Drain the X3®/Bypass Cartridge. Place a bucket or pan underneath cartridge to collect water during removal.
- 5 Locate the three (3) screws securing the X3®/Bypass cartridge as shown in Figure 22. Remove the (A) M4-12mm screw and the two (B) M4-25mm screws from cartridge. Place screws aside in a safe place for reinstallation.

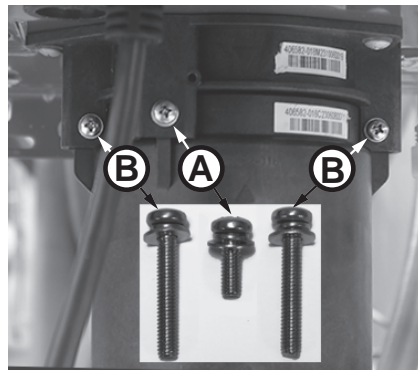

Figure 22 - Identify cartridge screws

- 6 Pull down to remove the cartridge from the water heater. Wait a few minutes to ensure all water has completely drained.
- 7 Locate and remove the inlet filter as shown in Figure 23 to drain any residual water left in the system. Place a bucket or pan underneath inlet filter to collect water during removal.

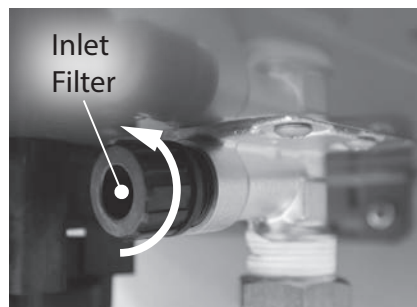

Figure 23 - Removing the inlet filter

- 8 Once the water heater has been adequately drained, reinstall inlet filter to water heater and tighten by hand. Confirm inlet filter is secured to water heater.
 - 9 Reinstall the cartridge to the water heater. Locate the screws previously removed in **Step 5**. Insert and snug all three (3) screws by hand.
- NOTICE:** The X3® cartridge is keyed to only install in one direction. Align the ▲ on the cartridge with the ▼ on the manifold (the arrows will be facing the backside of the water heater). When inserting the cartridge, push up until the screw holes align. Some resistance is normal. The bypass cartridge is not keyed and will install in either direction.
- 10 Use a screwdriver to tighten the two (B) screws first and lastly tighten screw (A). **DO NOT** use a drill or impact driver to tighten the screws.

Accessing Water Heater Components

- 11 Locate the two (2) screws at the bottom of the cabinet cover. Use a Phillips screwdriver to remove the screws. Place screws aside in a safe place for reinstallation.
- 12 Lift cover up and away from cabinet to gain access to the water heater's internal components.
- 13 Locate the User Interface Module (UIM) and bracket. Remove the four screws securing bracket to the water heater. Place screws aside in a safe place for reinstallation.

SERVICE (ELECTRONIC & WIRING COMPONENTS)

Removing the Heater Block Lower Wiring Assembly

- 14 Locate the heater block lower wiring harness. Reference Figure 6 on page 4 for location.
- 15 To disconnect, gently remove the security clip with a mini pick or fingernail. Push tab as shown in Figure 24. Separate the harnesses. Place security clip aside in a safe place for reinstallation.

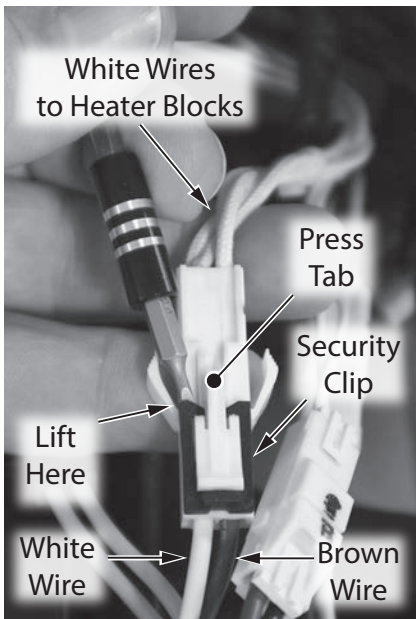

Figure 24 - Wiring security clip removal

- 16 Heater blocks B3 - B6 use a compression style clip as shown in Figure 27. Remove the compression clips and set aside in a safe place for reinstallation.

- 17 Locate the C clip securing B2 heater block to the hot water outlet piping. Remove the two screws securing C clip. Place screws and C clip aside in a safe place for reinstallation. See Figure 25.

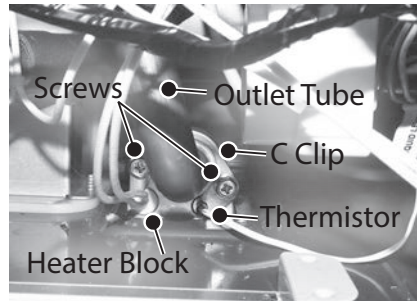

Figure 25 - Removing C clip and screws

⚠ CAUTION! Water may still be present in the valve assembly. Place a rag under the valve connection points to prevent water from escaping into the water heater cabinet.

- 18 Remove heater block B1 from the inlet water connection and set aside for reinstallation. See Figure 26.

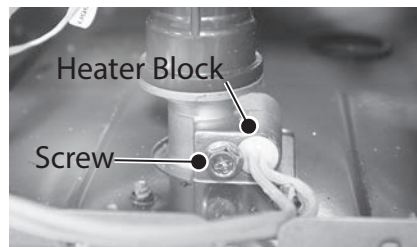

Figure 26 - Heater block location

⚠ CAUTION! Water may still be present in the valve assembly. Place a rag under the valve connection points to prevent water from escaping into the water heater cabinet.

- 19 Dispose of the old heater block lower wiring assembly properly.

Replacing the Heater Block Lower Wiring Assembly

- 20 Locate the new heater block lower wiring assembly provided in the kit.
- 21 Reconnect heater blocks B3 - B6 using the clips removed in **Step 16**. Use Figure 27 for location reference.
- 22 Reconnect heater block B2 using the C clip and screws removed in **Step 17**. Use Figure 27 for location reference.
- 23 Reconnect heater block B1 using the screws removed in **Step 18**. Use Figure 27 for location reference.
- 24 Reconnect heater block lower wiring harness and security clip removed in **Step 15**. Use Figure 27 for location reference.
- 25 Reinstall the UIM using the four screws removed in **Step 13**.

Checking for Water Leaks

- 26 Turn **ON** the cold water supply to the water heater at the cold inlet valve. The system will fully pressurize and any leaks at water connections will be apparent. Correct any leaks immediately and dry water heater cabinet with a rag.

Returning Water Heater to Operation

- 27 Replace the cabinet cover and secure with the screws previously removed in **Step 11**.
- 28 Restore power to the water heater. The water heater is now ready for operation.

SERVICE (ELECTRONIC & WIRING COMPONENTS)

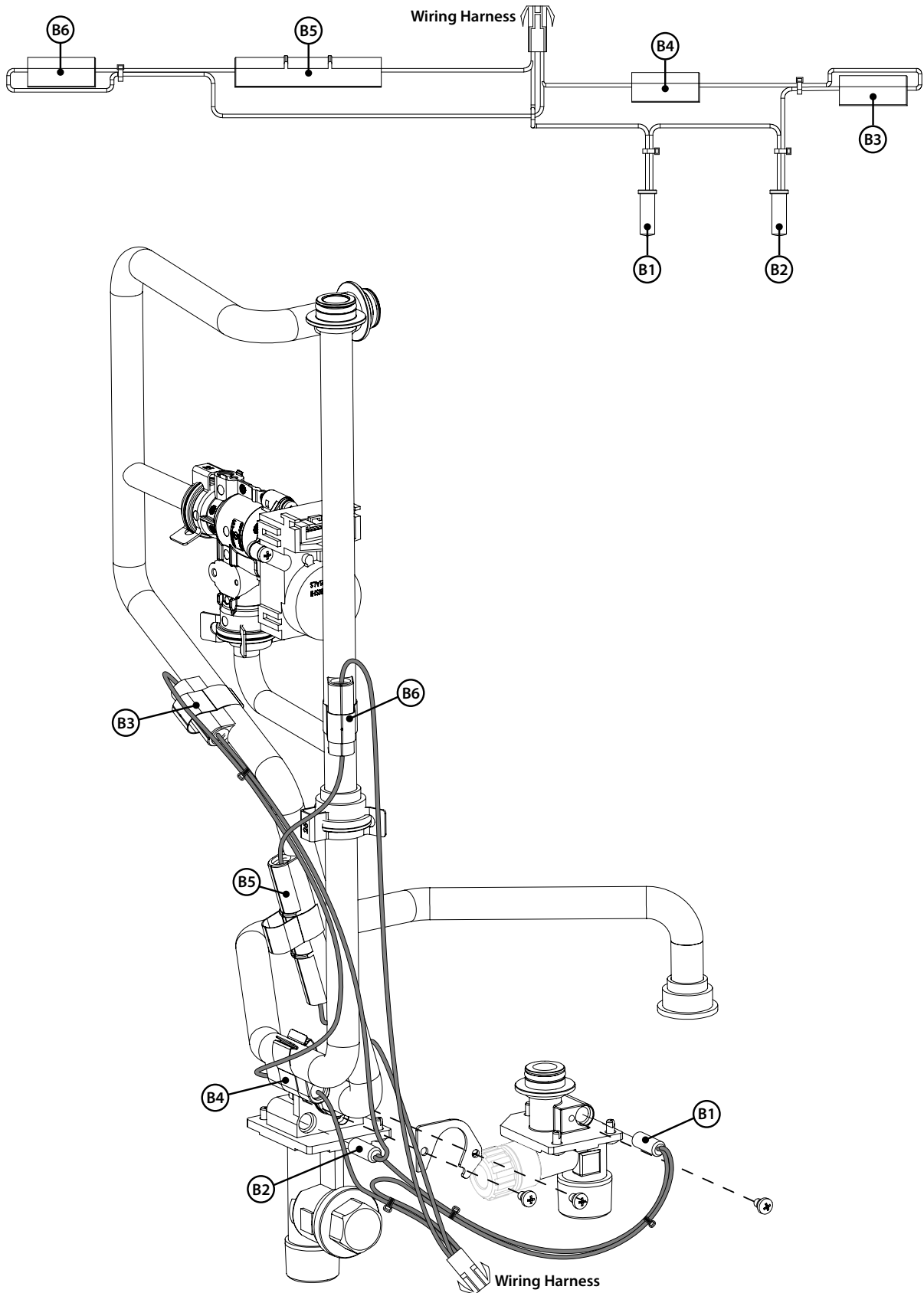

Figure 27 - Lower connection reference guide



SERVICE (ELECTRONIC & WIRING COMPONENTS)

THIS PAGE IS INTENTIONALLY LEFT BLANK

SERVICE (ELECTRONIC & WIRING COMPONENTS)

Main Wiring Harness Assembly

Kit 100390077 Contains:

- Main Wiring Harness
- Bypass Valve Extension Wire
- Kit Instructions

IMPORTANT: Use only factory authorized replacement parts. **DO NOT USE ELECTRIC SCREWDRIVERS OR DRILLS, HAND TIGHTEN ALL SCREWS TO PREVENT OVERTIGHTENING.** If you lack the necessary skills to properly perform the installation, you should not proceed, but get help from a qualified service technician.

Tools and Materials Required:

- Phillips Screwdriver
- Mini Pick
- Safety Gloves

Preparing Water Heater for Service

1 Disconnect power to the water heater by unplugging it or by turning off the circuit at the breaker box, as appropriate. The power button on the water heater and remote **DOES NOT** disconnect power to the water heater. You must physically disconnect power to the water heater.

Accessing Water Heater Components

2 Locate the two screws at the bottom of the cabinet cover. Use a Phillips screwdriver to remove the screws. Place screws aside in a safe place for reinstallation.

3 Lift cover up and away from cabinet to gain access to the water heater's internal components.

4 Locate the User Interface Module (UIM) and bracket. Remove the four screws securing bracket to the water heater. Place

screws aside in a safe place for reinstallation.

NOTICE: UIM, bracket and wiring do not need to be disconnected. Allow UIM and bracket to rest below water heater for easy access to the main wiring harness.

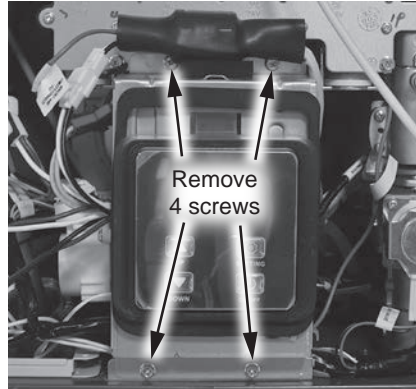

Figure 28 - Removing UIM and bracket screws

Removing the Main Wiring Harness

NOTICE: Plastic clips secure the main wiring harness at four locations. Slide the plastic clips towards the center of the water heater to remove them. They will stay with the harness.

5 Locate the exhaust thermistor wiring harness and disconnect it. See Figure 29.

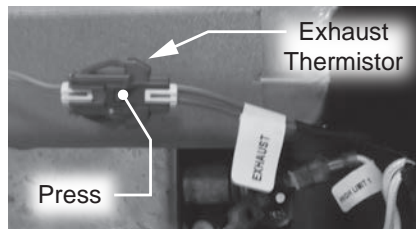

Figure 29 - Disconnecting exhaust thermistor

NOTICE: To disconnect the exhaust thermistor, use a pair of needle nose pliers to gently press down on the connector tab while pulling connections apart.

6 Locate the high limit 1 wiring harness and disconnect it. See Figure 30.

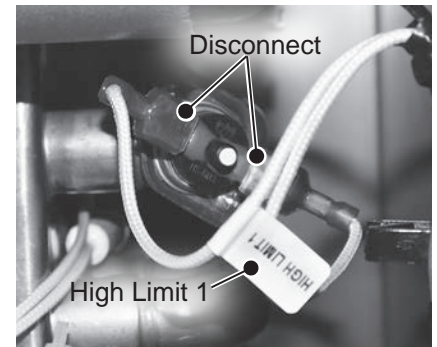

Figure 30 - Disconnecting high limit 1

7 Locate the high limit 2 wiring harness and disconnect it. See Figure 31.

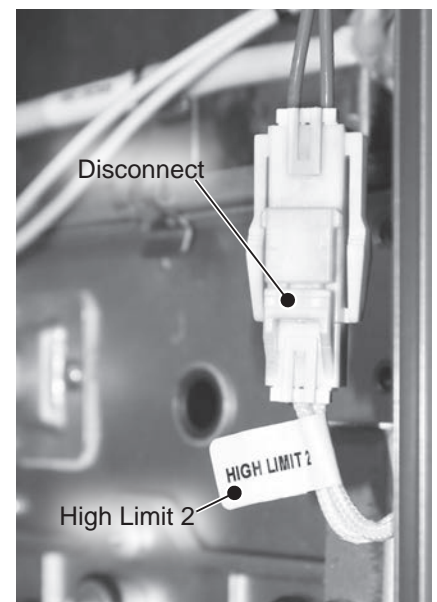

Figure 31 - Disconnecting high limit 2

8 Locate the ignitor assembly on the right side of the water heater. Remove the two screws securing the ignitor assembly and bracket to the gas manifold. Place screws aside in a safe place for reinstallation. See Figure 32.

SERVICE (ELECTRONIC & WIRING COMPONENTS)

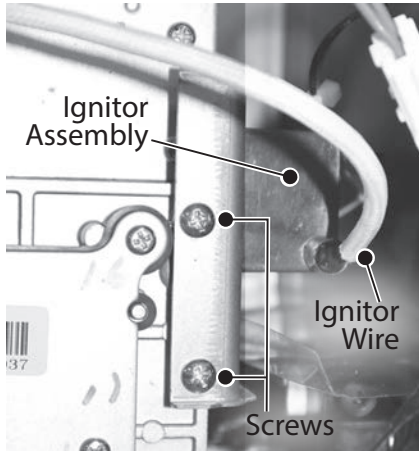

Figure 32 - Ignitor assembly location

- 9 Disconnect the two spade terminal connections at the back of ignitor assembly. See Figure 33.

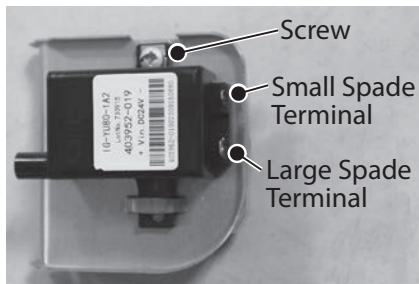

Figure 33 - Disconnecting ignitor assembly

- 10 Locate the Printed Circuit Board (PCB) on the right side of the water heater. Use a Phillips screwdriver to remove the two screws securing the PCB. Place screws aside in a safe place for reinstallation. See Figure 34.

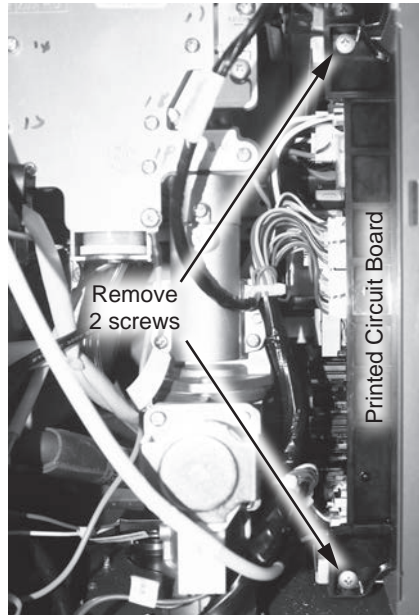

Figure 34 - Removing PCB screws

- 11 Gently slide PCB out from water heater far enough to access the wiring harnesses shown in Figure 35.

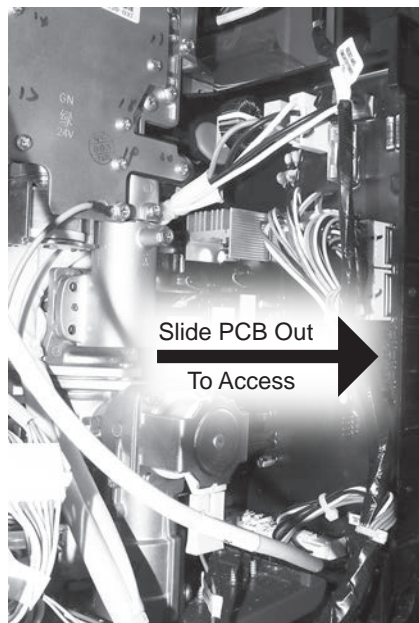

Figure 35 - Accessing PCB

- 12 Disconnect wiring harnesses A1 - A4. See Figure 36.

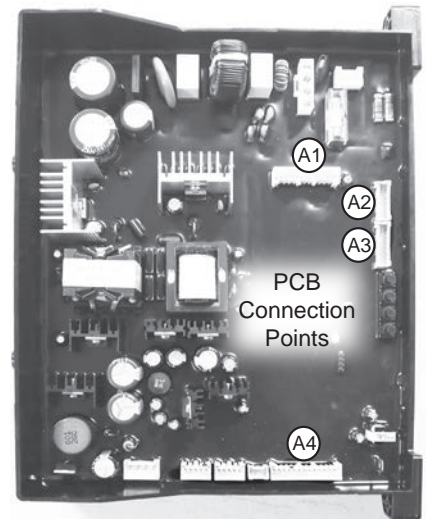

Figure 36 - Disconnecting wires A1-A4

NOTICE: On connection points A1 & A4, use an O-ring pick to apply pressure to the point shown in Figure 37 while pulling the harness from the board. Remove "locks" and place aside in a safe place for reinstallation.

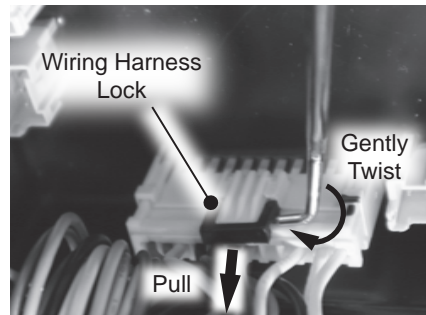

Figure 37 - Black harness lock removal

- 13 Locate the gas valve wiring harness and disconnect it. See Figure 38.
- 14 Locate the proportional valve wiring harness and disconnect it. See Figure 38.

SERVICE (ELECTRONIC & WIRING COMPONENTS)

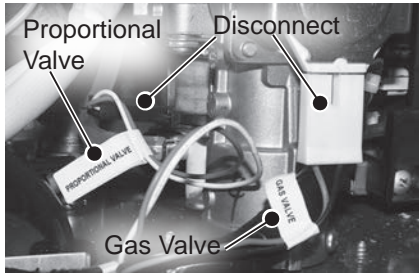

Figure 38 - Disconnecting gas valve and proportional valve

- 15 Locate the inlet thermistor wiring harness and disconnect it. See Figure 39.

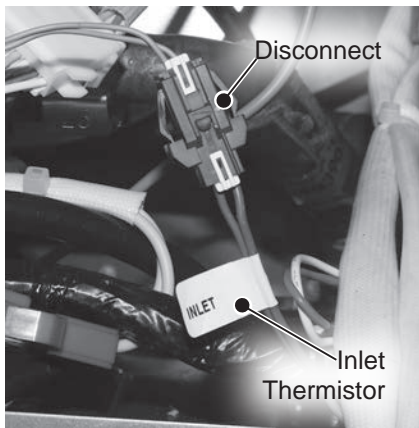

Figure 39 - Disconnecting inlet thermistor

NOTICE: To disconnect the inlet thermistor, use a pair of needle nose pliers to gently press down on the connector tab while pulling connections apart.

- 16 Locate the manifold wiring harness and disconnect it. See Figure 40.

- 17 Locate the flow wiring harness and disconnect it. See Figure 40.

NOTICE: To disconnect the flow thermistor, use a pair of needle nose pliers to gently press down on the connector tab while pulling connections apart.

- 18 Locate the outlet thermistor wiring harness and disconnect it. See Figure 40.

NOTICE: To disconnect the outlet thermistor, use a pair of needle nose pliers to gently press down on the connector tab while pulling connections apart.

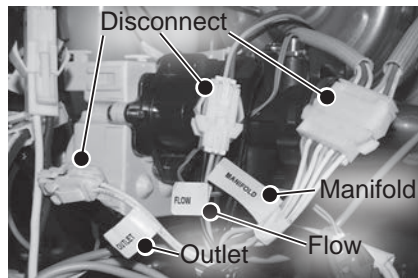

Figure 40 - Disconnecting manifold, flow & outlet

- 19 Locate the liquid level wiring harness and disconnect it. See Figure 41.

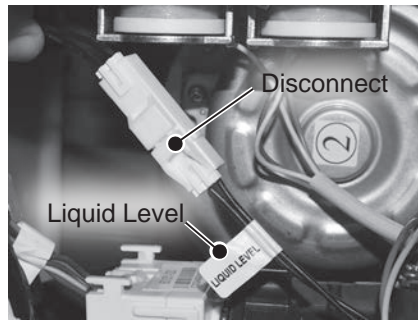

Figure 41 - Disconnecting liquid level

- 20 Locate the main water valve wiring harness and disconnect it. See Figure 42.

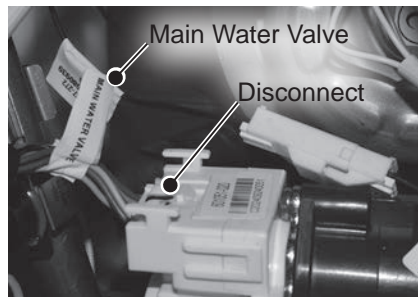

Figure 42 - Disconnecting main water valve

- 21 Locate the HEX thermistor wiring harness and disconnect it. See Figure 43.



Figure 43 - Disconnecting HEX thermistor

NOTICE: To disconnect the HEX thermistor, use a pair of needle nose pliers to gently press down on the connector tab while pulling connections apart.



SERVICE (ELECTRONIC & WIRING COMPONENTS)

- 22 Locate the water valve 1 wiring harness and extension wire connected to the bypass valve. Disconnect wiring at the bypass valve. See Figure 44.

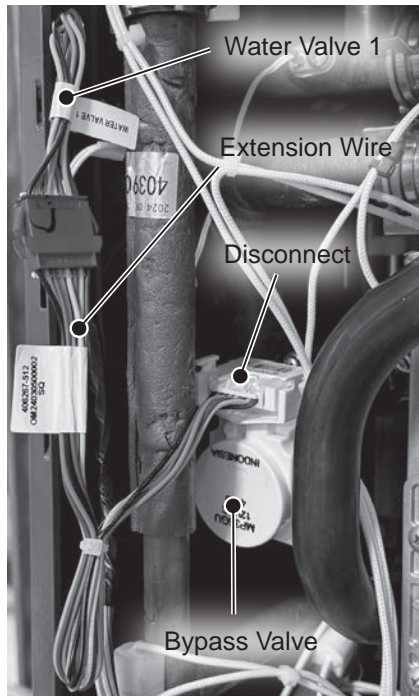

Figure 44 - Disconnecting water valve 1 and extension wire

- 23 Remove the main wiring harness assembly with extension wire and dispose of it properly.

Replacing the Main Wiring Harness

- 24 Locate the new main wiring harness provided in the kit.
- 25 Reconnect the exhaust thermistor harness removed in Step 5.
- 26 Reconnect the high limit 1 harness removed in Step 6.
- 27 Reconnect the high limit 2 harness removed in Step 7.

- 28 Reconnect the ignitor assembly wiring disconnected in Step 9. Secure ignitor assembly to gas manifold with the two screws previously removed in Step 8.

- 29 Reconnect harnesses A1 - A4 removed from the PCB in Step 12.

- 30 Reconnect the gas valve harness removed in Step 13.

- 31 Reconnect the proportional valve harness removed in Step 14.

- 32 Reconnect the inlet thermistor harness removed in Step 15.

- 33 Reconnect the manifold harness removed in Step 16.

- 34 Reconnect the flow thermistor harness removed in Step 17.

- 35 Reconnect the outlet thermistor harness removed in Step 18.

- 36 Reconnect the liquid level harness removed in Step 19.

- 37 Reconnect the main water valve harness removed in Step 20.

- 38 Reconnect the HEX thermistor harness removed in Step 21.

- 39 Locate the extension wire provided in the kit. Connect the blue end of extension wire to the water valve 1 harness. Connect the white end of extension wire to the bypass valve previously disconnected in Step 22.

- 40 With the wiring harnesses secured, slide PCB back into position and secure PCB to mounting brackets with the two screws previously removed in Step 10.

Installing UIM and Bracket

- 41 Secure the User Interface Module (UIM) and bracket to water heater with the four screws previously removed in Step 4. Confirm all electrical connections are snug and properly routed behind bracket.

Returning Water Heater to Operation

- 42 Replace the cabinet cover and secure with the screws previously removed in Step 2.
- 43 Restore power to the water heater. The water heater is now ready for operation.

SERVICE (ELECTRONIC & WIRING COMPONENTS)

Freeze Protection & Power Wire Harness Assembly

Kit 100390071 Contains:

- Freeze Protection/Power Wire Harness
- Kit Instructions

IMPORTANT: Use only factory authorized replacement parts. **DO NOT USE ELECTRIC SCREWDRIVERS OR DRILLS, HAND TIGHTEN ALL SCREWS TO PREVENT OVERTIGHTENING.** If you lack the necessary skills to properly perform the installation, you should not proceed, but get help from a qualified service technician.

Tools and Materials Required:

- Phillips Screwdriver
- Cable Tie
- O-ring Pick
- Safety Gloves

Preparing Water Heater for Service

1 Disconnect power to the water heater by unplugging it or by turning off the circuit at the breaker box, as appropriate. The power button on the water heater and remote **DOES NOT** disconnect power to the water heater. You must physically disconnect power to the water heater.

Accessing Water Heater Components

2 Locate the two screws at the bottom of the cabinet cover. Use a Phillips screwdriver to remove the screws. Place screws aside in a safe place for reinstallation.

3 Lift cover up and away from cabinet to gain access to the water heater's internal components.

4 Locate the Printed Circuit Board (PCB) on the right side of the water heater. Use a Phillips

screwdriver to remove the two screws securing the PCB. Place screws aside in a safe place for reinstallation. See Figure 45.

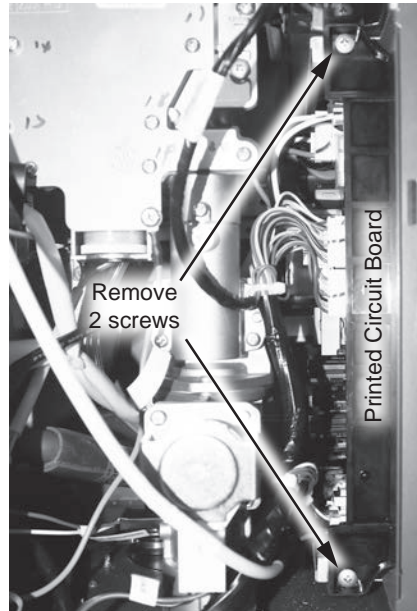

Figure 45 - Removing PCB screws

5 Gently slide PCB out from water heater enough to access wiring harnesses A1 - A2. See Figure 46.

Replacing the Freeze Protection/Power Wire Harness

6 Using Figure 46 as reference, disconnect the wiring harnesses A1 and A2 from the PCB.

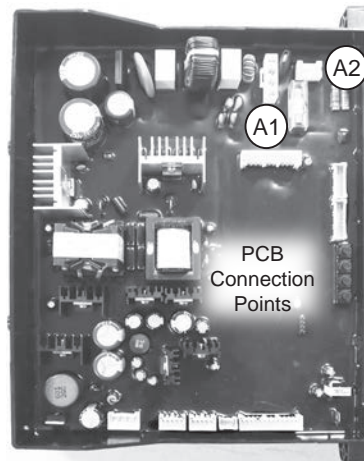

Figure 46 - Disconnecting PCB wiring

7 Most connection points use a simple, compression type harness. Grasp each harness in the middle and squeeze with a gentle pull to disconnect them.

NOTICE: Wiring harness "A2" has a plastic "lock" to ensure it does not disconnect from the board. Use the following steps to assist in disconnecting this connection.

8 On connection point "A2", use an O-ring pick to apply pressure to the point shown in Figure 47 while pulling the harness from the board. Remove "lock" and place aside in a safe place for reinstallation.

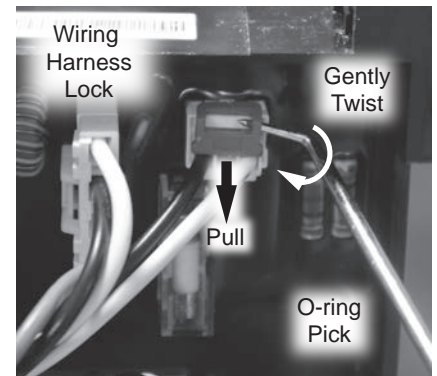

Figure 47 - Red harness lock removal

9 Remove the cable tie securing the wiring harness to the UIM bracket. See Figure 48.

10 Remove the screws securing the two ground wires. Place the screws aside in a safe place for reinstallation. See Figure 48.

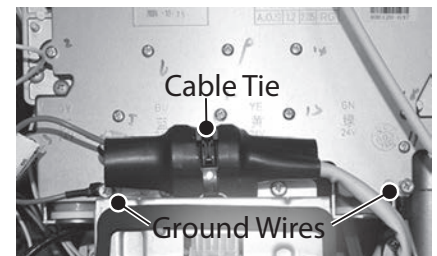

Figure 48 - Ground wires and cable tie removal.

11 Locate the 4 wiring harnesses to the left of the UIM and disconnect them. See Figure 49.

SERVICE (ELECTRONIC & WIRING COMPONENTS)

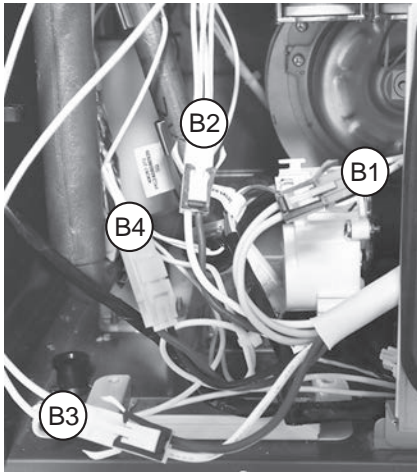

Figure 49 - Wiring harness "B1-B4" location

- 12 Wiring harness connections B1 - B3 use a security clip. Reference Figure 49 for location.
- 13 To disconnect wiring harnesses B1 - B3, gently remove the security clip with a mini pick or fingernail. Push tab as shown in Figure 50. Separate the harnesses. Place security clip aside in a safe place for reinstallation.

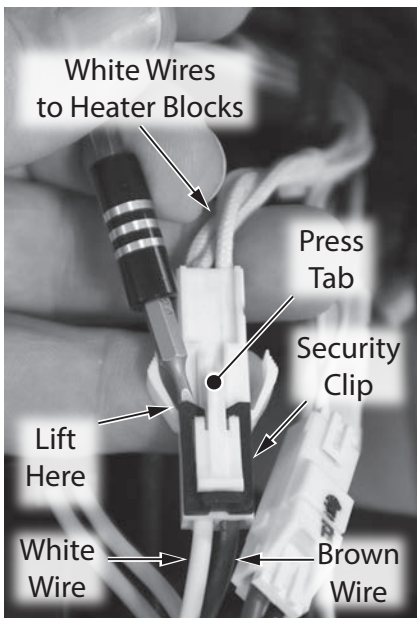

Figure 50 - Wiring security clip removal

- 14 Disconnect wiring harness B4. Reference Figure 49 for location.
- 15 Disconnect wiring harness B5. Reference Figure 51 for location.

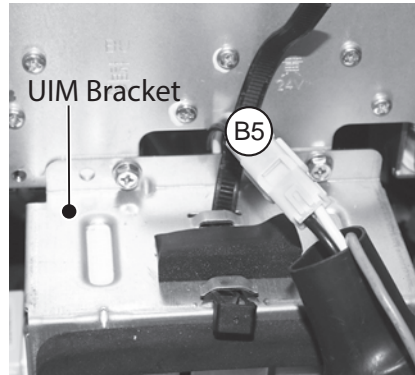

Figure 51 - Wiring harness "B5" location

- 16 Remove the old freeze protection/power wiring harness and dispose of it properly.

Replacing the Freeze Protection/Power Harness.

- 17 Locate the new freeze protection/power wiring harness provided in the kit.
- 18 Reconnect wiring harness B5 disconnected in Step 15.
- 19 Use a cable tie to secure the wiring harnesses to the UIM removed in Step 9.
- 20 Reconnect the two ground wires removed in Step 10.
- 21 Route wiring harnesses B1 - B4 behind the UIM bracket.
- 22 Reconnect wiring harness B4 disconnected in Step 14.
- 23 Reconnect wiring harnesses B1 - B3 disconnected in Step 13.

- 24 Route wiring harnesses A1 - A2 behind the gas valve to access the PCB.
- 25 Reconnect the wiring harnesses A1 - A2 to the PCB as removed in Step 6.
- 26 With the wiring harnesses secured, slide PCB back into position and secure PCB to mounting brackets with the two screws previously removed in Step 4.

Returning Water Heater to Operation

- 27 Replace the cabinet cover and secure with the screws previously removed in Step 2.
- 28 Restore power to the water heater. The water heater is now ready for operation.

SERVICE (ELECTRONIC & WIRING COMPONENTS)

Printed Circuit Board

Kit 100390074 Contains:

- Printed Circuit Board (TM-160)
- Kit Instructions

Kit 100390073 Contains:

- Printed Circuit Board (TM-180)
- Kit Instructions

Kit 100390072 Contains:

- Printed Circuit Board (TM-199)
- Kit Instructions

IMPORTANT: Use only factory authorized replacement parts. **DO NOT USE ELECTRIC SCREWDRIVERS OR DRILLS, HAND TIGHTEN ALL SCREWS TO PREVENT OVERTIGHTENING.** If you lack the necessary skills to properly perform the installation, you should not proceed, but get help from a qualified service technician.

Tools and Materials Required:

- Phillips Screwdriver
- O-Ring Pick
- Safety Gloves

Preparing Water Heater for Service

1 Disconnect power to the water heater by unplugging it or by turning off the circuit at the breaker box, as appropriate. The power button on the water heater and remote **DOES NOT** disconnect power to the water heater. You must physically disconnect power to the water heater.

Accessing Water Heater Components

2 Locate the two screws at the bottom of the cabinet cover. Use a Phillips screwdriver to remove the screws. Place screws aside in a safe place for reinstallation.

3 Lift cover up and away from cabinet to gain access to the water heater's internal components.

IMPORTANT! Note the fan designation number provided on the label located in the center of the fan assembly. This fan designation number will be used later to properly configure the water heater. See Figure 52.

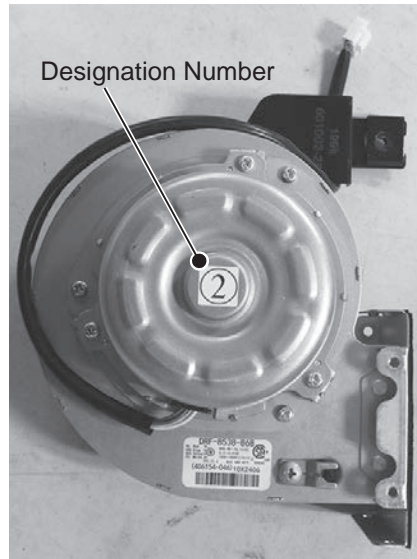

Figure 52 - Fan designation number

Removing the Printed Circuit Board (PCB)

4 Locate the Printed Circuit Board on the right side of the water heater. Use a Phillips screwdriver to remove the two screws securing the PCB. Place screws aside in a safe place for reinstallation. See Figure 53.

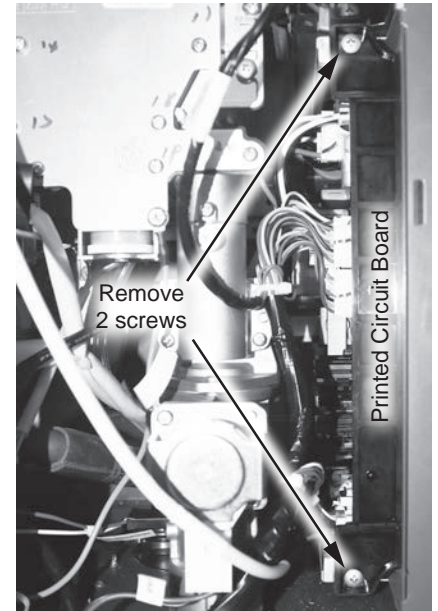

Figure 53 - Removing PCB screws

- 5** Gently slide PCB out from water heater.
- 6** Using Figure 54 as reference, disconnect the wiring harnesses A through I from the PCB.

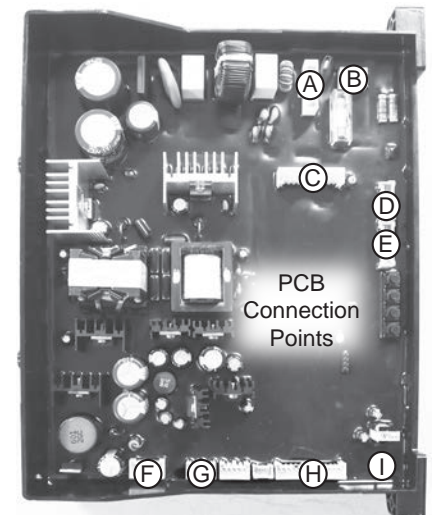

Figure 54 - Disconnecting PCB wiring

SERVICE (ELECTRONIC & WIRING COMPONENTS)

7 Most connection points use a simple, compression type harness. Grasp each harness in the middle and squeeze with a gentle pull to disconnect them.

NOTICE: Wiring harnesses "B", "C", and "H" have plastic "locks" to ensure the harnesses do not disconnect from the board. Use the following steps to assist in disconnecting those connections.

8 On connection point "B", use an O-ring pick to apply pressure to the point shown in Figure 55 while pulling the harness from the board. Remove "lock" and place aside in a safe place for reinstallation.

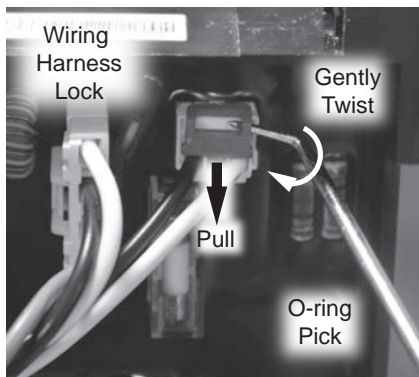

Figure 55 - Red harness lock removal

9 On connection points "C" and "H", use an O-ring pick to apply pressure to the point shown in Figure 56 while pulling the harness from the board. Remove "locks" and place aside in a safe place for reinstallation.

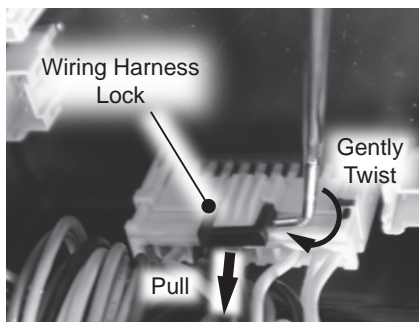

Figure 56 - Black harness lock removal

10 Connection point "I" uses a standard blade style connector. Gently pull to remove.

Replacing the Printed Circuit Board (PCB)

11 Locate the new PCB provided in the kit.

12 Reconnect the wiring harnesses removed in **Steps 6-10**. Reference Figure 54 for placement of each wiring harness.

13 Reconnect the "locks" on wiring harnesses "B", "C", and "H". See Figure 55 and Figure 56 for reference.

14 With the wiring harnesses secured, slide PCB back into position and secure PCB to mounting brackets with the two screws previously removed in **Step 4**.

Returning Water Heater to Operation

15 Replace the cabinet cover and secure with the screws previously removed in **Step 2**.

16 Restore power to the water heater.

Configuring Water Heater

The water heater must be configured to operate as intended with the new PCB.

Use the tables and information found in the "Configuration Mode (C Mode)" section of this Service Handbook to properly configure the system.

17 Configure water heater settings **C01** (altitude), **C08** (vent size), **C02** (vent length) and lastly **C04**.

IMPORTANT! Configuration settings must be done in the order described above. See the "Configuration Mode (C Mode)" section of this Service Handbook for **C01**, **C08** and **C02** setting information.

18 Configure water heater setting **C04** to match the fan designation number on the fan assembly recorded in **Step 3**. See Figure 52 as reference.

The water heater is now ready for operation.

SERVICE (ELECTRONIC & WIRING COMPONENTS)

Ignitor Assembly

Kit 100390067 Contains:

- Ignitor Assembly
- Kit Instructions

IMPORTANT: Use only factory authorized replacement parts. **DO NOT USE ELECTRIC SCREWDRIVERS OR DRILLS, HAND TIGHTEN ALL SCREWS TO PREVENT OVER TIGHTENING.** If you lack the necessary skills to properly perform the installation, you should not proceed, but get help from a qualified service technician.

Tools and Materials Required:

- Phillips Screwdriver
- Safety Gloves

Preparing Water Heater for Service

- 1 Disconnect power to the water heater by unplugging it or by turning off the circuit at the breaker box, as appropriate. The power button on the water heater and remote **DOES NOT** disconnect power to the water heater. You must physically disconnect power to the water heater.

Accessing Water Heater Components

- 2 Locate the two screws at the bottom of the cabinet cover. Use a Phillips screwdriver to remove the screws. Place screws aside in a safe place for reinstallation.
- 3 Lift cover up and away from cabinet to gain access to the water heater's internal components.

Removing the Ignitor Assembly

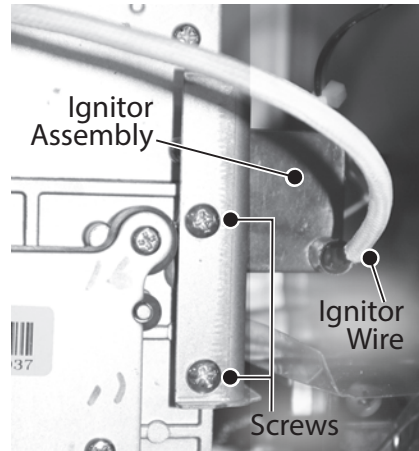

Figure 57 - Ignitor assembly location

- 4 Locate the ignitor assembly on the right side of the water heater. See Figure 57.
- 5 Disconnect the ignitor wire from the ignitor assembly.
- 6 Remove the two screws securing the ignitor assembly and bracket to the gas manifold. Place screws aside in a safe place for reinstallation. See Figure 57.
- 7 Disconnect the two spade terminal connections at the back of ignitor and remove ignitor assembly and bracket from water heater. See Figure 58.
- 8 Locate the screw securing the ignitor to the bracket. Remove screw and place aside in a safe place for reinstallation. See Figure 58.

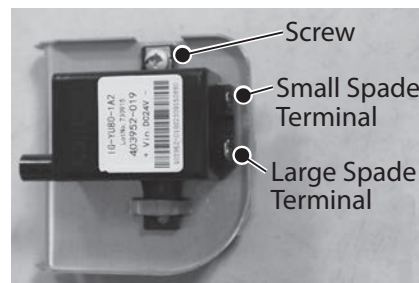

Figure 58 - Ignitor assembly location

- 9 Remove ignitor from bracket and dispose of properly.

NOTICE: Do not dispose of bracket. Bracket will be used to mount and secure new ignitor.

Replacing the Ignitor Assembly

- 10 Locate the new ignitor assembly provided in the kit. Secure ignitor to bracket with screw previously removed in **Step 8**.
- 11 Connect the two spade terminal connections to the new ignitor assembly. Confirm electrical connections are tight.

NOTICE: There is one large and one small spade terminal connection.

- 12 Mount the new ignitor assembly to the gas manifold and secure with the two screws previously removed in **Step 6**.
- 13 Reconnect the ignitor wire previously removed in **Step 5**.

Returning Water Heater to Operation

- 14 Replace the cabinet cover and secure with the two screws previously removed in **Step 2**.
- 15 Restore power to the water heater. The water heater is now ready for operation.

SERVICE (ELECTRONIC & WIRING COMPONENTS)

Flame Sensor Wire

Kit 100390069 Contains:

- Flame Sensor Wire
- Kit Instructions

IMPORTANT: Use only factory authorized replacement parts. **DO NOT USE ELECTRIC SCREWDRIVERS OR DRILLS, HAND TIGHTEN ALL SCREWS TO PREVENT OVER TIGHTENING.** If you lack the necessary skills to properly perform the installation, you should not proceed, but get help from a qualified service technician.

Tools and Materials Required:

- Phillips Screwdriver
- Safety Gloves

Preparing Water Heater for Service

- 1 Disconnect power to the water heater by unplugging it or by turning off the circuit at the breaker box, as appropriate. The power button on the water heater and remote **DOES NOT** disconnect power to the water heater. You must physically disconnect power to the water heater.

Accessing Water Heater Components

- 2 Locate the two screws at the bottom of the cabinet cover. Use a Phillips screwdriver to remove the screws. Place screws aside in a safe place for reinstallation.
- 3 Lift cover up and away from cabinet to gain access to the water heater's internal components.

Replacing the Flame Sensor Wire

- 4 Disconnect flame sensor wire from flame sensor rod and the Printed Circuit Board (PCB). Dispose of properly. See Figure 59.

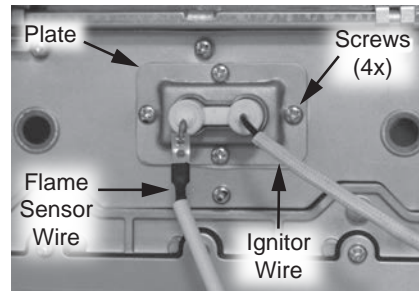

Figure 59 - Ignitor rod and flame sensor rod assembly

NOTICE: If flame sensor wire is difficult to disconnect from PCB, remove the two screws securing PCB to water heater. Gently slide PCB out from water heater to improve access to flame sensor connection.

- 5 Locate new flame sensor wire provided in the kit. Connect new wire to flame sensor rod and PCB. If PCB was removed for improved access, gently slide PCB back into place and secure with the two screws.

Returning Water Heater to Operation

- 6 Replace the cabinet cover and secure with the two screws previously removed in **Step 2**.
- 7 Restore power to water heater and proceed.

The water heater is now ready for operation.

SERVICE (ELECTRONIC & WIRING COMPONENTS)

Exhaust and Water Inlet Thermistor

Kit 100390060 Contains:

- Exhaust/Inlet Thermistor
- O-Ring (3.8 x 1.9 EPDM)
- Metal Clip
- Fan Clip
- Kit Instructions

NOTICE: The fan clip is not used to service this model and can be discarded.

IMPORTANT: Use only factory authorized replacement parts. **DO NOT USE ELECTRIC SCREWDRIVERS OR DRILLS, HAND TIGHTEN ALL SCREWS TO PREVENT OVER TIGHTENING.** If you lack the necessary skills to properly perform the installation, you should not proceed, but get help from a qualified service technician.

Tools and Materials Required:

- Phillips Screwdriver
- O-ring Pick
- Bucket or Pan (Inlet Thermistor)
- Towel or Rag
- Safety Gloves

WARNING!
This kit shall be installed by a qualified service agency in accordance with the manufacturer's instructions and all applicable codes and requirements of the authority having jurisdiction. The information in these instructions must be followed to minimize the risk of fire or explosion or to prevent property damage, personal injury or death. The qualified service agency is responsible for the proper installation of this kit.

Preparing Water Heater for Service

- 1 Disconnect power to the water heater by unplugging it or by turning off the circuit at the breaker box, as appropriate. The power button on the water heater and remote **DOES NOT** disconnect power to the water heater. You must physically disconnect power to the water heater.
- 2 If replacing the exhaust thermistor, shut **OFF** the gas supply to the water heater at the manual gas shut off valve.
- 3 If replacing the inlet thermistor, shut **OFF** the cold water supply to the water heater at the cold inlet valve.
- 4 If replacing the inlet thermistor, open all hot water fixtures in the house. When the residual water flow has ceased, close all hot water

fixtures. This will depressurize the water heater.

IMPORTANT! If replacing the exhaust thermistor, proceed to **Step 12**. If replacing the inlet thermistor, proceed to the next section to drain the water heater.

Draining the Water Heater

- 5 Drain the X3®/Bypass Cartridge. Place a bucket or pan underneath cartridge to collect water during removal.
- 6 Locate the three screws securing the X3®/Bypass cartridge as shown in Figure 60. Remove the (A) M4-12mm screw and the two (B) M4-25mm screws from cartridge. Place screws aside in a safe place for reinstallation.

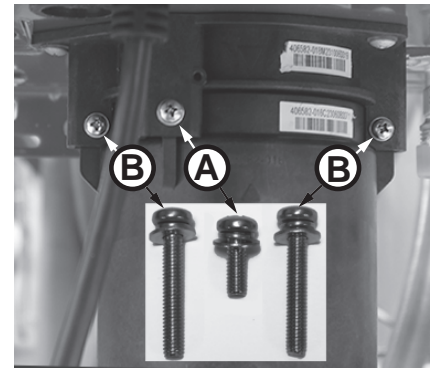

Figure 60 - Identify cartridge screws

- 7 Pull down to remove the cartridge from the water heater. Wait a few minutes to ensure all water has completely drained.
- 8 Locate and remove the inlet filter as shown in Figure 61 to drain any residual water left in the system. Place a bucket or pan underneath inlet filter to collect water during removal.

SERVICE (ELECTRONIC & WIRING COMPONENTS)

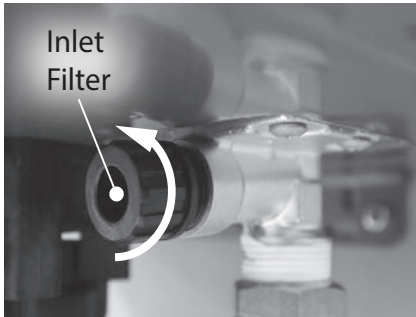

Figure 61 - Removing the inlet filter

- 9 Once the water heater has been adequately drained, reinstall inlet filter to water heater and tighten by hand. Confirm inlet filter is secured to water heater.
- 10 Reinstall the cartridge to the water heater. Locate the screws previously removed in **Step 6**. Insert and snug all three screws by hand.

NOTICE: The X3® cartridge is keyed to only install in one direction. Align the ▲ on the cartridge with the ▼ on the manifold (the arrows will be facing the backside of the water heater). When inserting the cartridge, push up until the screw holes align. Some resistance is normal. The bypass cartridge is not keyed and will install in either direction.

- 11 Use a screwdriver to tighten the two **B** screws first and lastly tighten screw **A**. **DO NOT** use a drill or impact driver to tighten the screws.

Accessing Water Heater Components

- 12 Locate the two screws at the bottom of the cabinet cover. Use a Phillips screwdriver to remove the screws. Place screws aside in a safe place for reinstallation.
- 13 Lift cover up and away from cabinet to gain access to the water heater's internal components.

Thermistor Replacement

This kit can be used to replace the following water thermistors:

- Exhaust - See **Step 14**.
- Water Inlet - See **Step 22**.

Removing the Exhaust Thermistor

- 14 Locate the exhaust thermistor as shown in Figure 62.

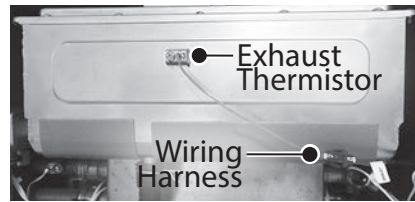

Figure 62 - Exhaust thermistor location

- 15 Locate the screw securing the exhaust thermistor. See Figure 63. Use a Phillips screwdriver to remove the screw. Place the screw aside in a safe place for reinstallation. Discard metal clip.

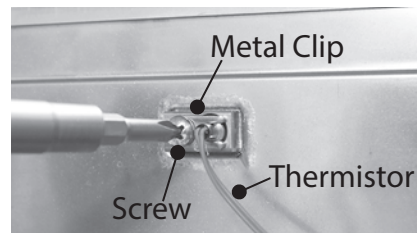

Figure 63 - Exhaust thermistor removal

- 16 Disconnect the thermistor wiring harness marked "EXHAUST". See Figure 64.

NOTICE: To disconnect the exhaust thermistor, use a pair of needle nose pliers to gently press down on the connector tab while pulling connections apart.

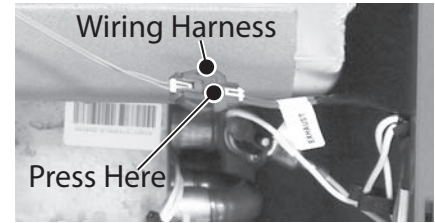

Figure 64 - Wiring harness location

- 17 Use a mini pick or hook to remove the thermistor O-ring seated in the thermistor housing. Dispose of the O-ring properly.
- 18 Dispose of the old exhaust thermistor properly.

Replacing the Exhaust Thermistor

- 19 Locate the new exhaust thermistor, metal clip and O-ring provided in the kit. Install O-ring on the thermistor. See Figure 65.

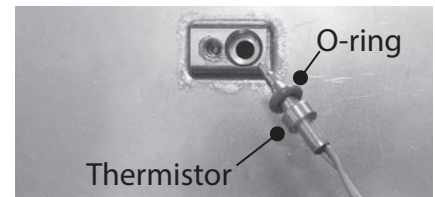

Figure 65 - New O-ring installation

- 20 Install the new exhaust thermistor in the water heater. See Figure 63. Secure with the new metal clip supplied in the kit and the screw removed in **Step 15**.
- 21 Proceed to **Step 33** to leak check and return water heater to operation.

SERVICE (ELECTRONIC & WIRING COMPONENTS)

Removing the Water Inlet Thermistor

22 Remove the four screws securing the user interface module (UIM) bracket. Place screws aside in a safe place for reinstallation.

NOTICE: UIM, bracket and wiring do not need to be disconnected. Allow UIM and bracket to rest below water heater for easy access to the inlet thermistor.

23 Locate the water inlet thermistor as shown in Figure 66.

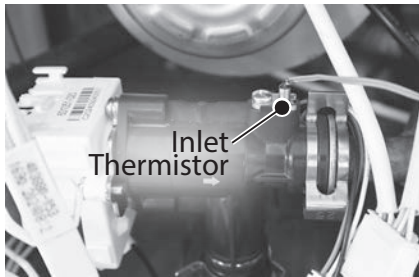

Figure 66 - Water inlet thermistor location

24 Locate the screw securing water inlet thermistor and clip to the flow sensor as shown in Figure 67. Remove the screw and clip. Place the screw aside in a safe place for reinstallation. Discard metal clip.

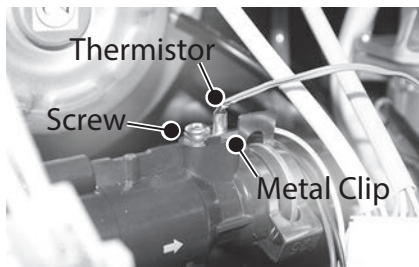

Figure 67 - Water inlet thermistor removal

25 Disconnect the thermistor at the wiring harness marked "INLET" as shown in Figure 68.

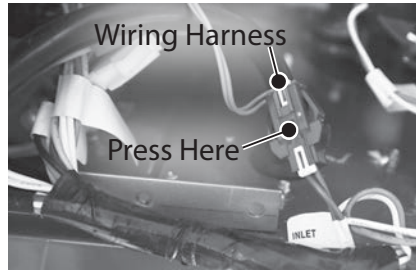

Figure 68 - Wiring harness removal

26 Remove the old water inlet thermistor and dispose of it properly.

27 Use a mini pick or hook to remove the water inlet thermistor O-ring seated in the flow sensor. Dispose of the O-ring properly.

Replacing the Water Inlet Thermistor

28 Locate the new thermistor, metal clip, and O-ring provided in the kit. Install the O-ring on the thermistor. See Figure 69.

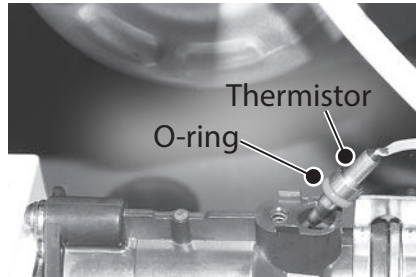

Figure 69 - Thermistor O-ring installation

29 Install the new water inlet thermistor and O-ring in the water heater. See Figure 67. Secure with the new metal clip and the screw removed in **Step 24**.

30 Connect the new thermistor wiring harness to the harness marked "INLET." See Figure 68.

31 Reinstall the user interface module (UIM) bracket using the four screws removed previously removed in **Step 22**.

32 Proceed to **Step 37** to leak check the water and return water heater to operation.

Checking for Gas Leaks

IMPORTANT! DO NOT apply liquids to any of the electrical connections when checking for gas leaks. Use a towel or rag to protect any electrical components.

33 Turn **ON** the gas supply to the water heater at the manual gas shut off valve. Restore power to the water heater. Open all hot water fixtures in the house. This will initiate the call for heat at the water heater.

34 Use code approved methods to check for leaks around all gas connection points. If any leaks are detected, resecure components and recheck for leaks.

35 Close all hot water fixtures in the house once the check is complete.

36 Replace the cabinet cover and secure with the screws previously removed in **Step 12**.

The water heater is now ready for operation.

Checking for Water Leaks

37 Turn **ON** the cold water supply to the water heater at the cold inlet valve. The system will fully pressurize and any leaks at water connections will be apparent. Correct any leaks immediately and dry water heater cabinet with a rag.

38 Replace the cabinet cover and secure with the screws previously removed in **Step 12**.

39 Restore power to the water heater.

The water heater is now ready for operation.

SERVICE (ELECTRONIC & WIRING COMPONENTS)

Heat Exchanger and Water Outlet Thermistor

Kit 100371196 Contains:

- Water Thermistor
- O-ring (3.8 x 1.9 NBR)
- Metal Clip
- Kit Instructions

IMPORTANT: Use only factory authorized replacement parts. **DO NOT USE ELECTRIC SCREWDRIVERS OR DRILLS, HAND TIGHTEN ALL SCREWS TO PREVENT OVER TIGHTENING.** If you lack the necessary skills to properly perform the installation, you should not proceed, but get help from a qualified service technician.

Tools and Materials Required:

- Phillips Screwdriver
- O-ring Pick
- Bucket or Pan
- Towel or Rag
- Safety Gloves

Preparing Water Heater for Service

- 1 Disconnect power to the water heater by unplugging it or by turning off the circuit at the breaker box, as appropriate. The power button on the water heater and remote **DOES NOT** disconnect power to the water heater. You must physically disconnect power to the water heater.
- 2 Shut **OFF** the gas supply to the water heater at the manual gas shut off valve.
- 3 Shut **OFF** the cold water supply to the water heater at the cold inlet valve.
- 4 Open all hot water fixtures in the house. When the residual water flow has ceased, close all hot water fixtures. This will depressurize the water heater.

Draining the Water Heater

- 5 Drain the X3®/Bypass Cartridge. Place a bucket or pan underneath cartridge to collect water during removal.
- 6 Locate the three screws securing the X3®/Bypass cartridge as shown in Figure 70. Remove the (A) M4-12mm screw and the two (B) M4-25mm screws from cartridge. Place screws aside in a safe place for reinstallation.

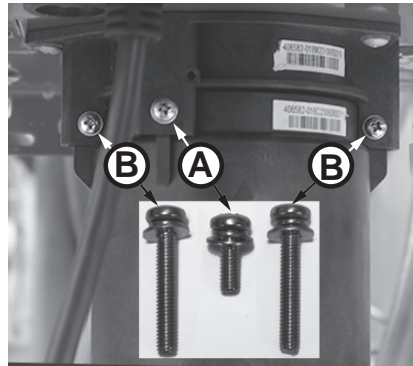

Figure 70 - Identify cartridge screws

- 7 Pull down to remove the cartridge from the water heater. Wait a few minutes to ensure all water has completely drained.
- 8 Locate and remove the inlet filter as shown in Figure 71 to drain any residual water left in the system. Place a bucket or pan underneath inlet filter to collect water during removal.

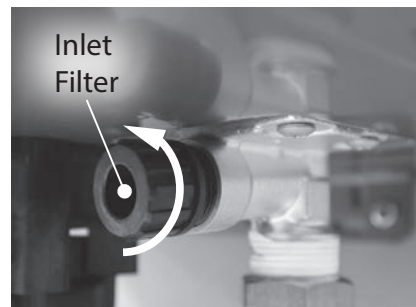

Figure 71 - Removing the inlet filter

- 9 Once the water heater has been adequately drained, reinstall inlet filter to water heater and tighten by hand. Confirm inlet filter is secured to water heater.
 - 10 Reinstall the cartridge to the water heater. Locate the screws previously removed in **Step 6**. Insert and snug all three screws by hand.
- NOTICE:** The X3® cartridge is keyed to only install in one direction. Align the ▲ on the cartridge with the ▼ on the manifold (the arrows will be facing the backside of the water heater). When inserting the cartridge, push up until the screw holes align. Some resistance is normal. The bypass cartridge is not keyed and will install in either direction.
- 11 Use a screwdriver to tighten the two (B) screws first and lastly tighten screw (A). **DO NOT** use a drill or impact driver to tighten the screws.

Accessing Water Heater Components

- 12 Locate the two screws at the bottom of the cabinet cover. Use a Phillips screwdriver to remove the screws. Place screws aside in a safe place for reinstallation.
- 13 Lift cover up and away from cabinet to gain access to the water heater's internal components.

Water Thermistor Replacement

This kit can be used to replace the following water thermistors:

- Water Outlet - See **Step 14**.
- Heat Exchanger Outlet - See **Step 21**.

SERVICE (ELECTRONIC & WIRING COMPONENTS)

Removing the Water Outlet Thermistor

14 Locate the hot water outlet thermistor and the two screws securing the hot water outlet thermistor. See Figure 72. Use a Phillips screwdriver to remove the screws and the C Clip. Place the screws and C Clip aside in a safe place for reinstallation.

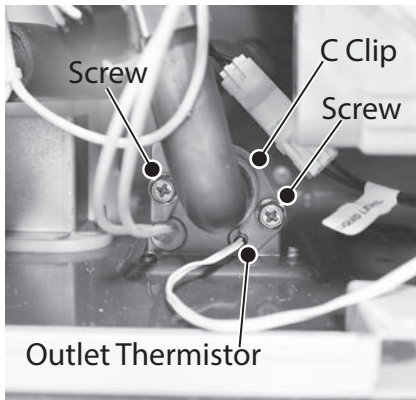

Figure 72 - Outlet thermistor location

15 Disconnect the thermistor wiring harness marked "OUTLET". See Figure 73.

NOTICE: Press in the location shown in Figure 4 to disconnect the wiring harness.



Figure 73 - Wiring harness location

16 Use a mini pick or hook to remove the water inlet thermistor O-ring seated in the water outlet base. Dispose of the O-ring properly.

17 Dispose of the old thermistor properly.

Replacing the Water Outlet Thermistor

18 Locate the new thermistor and O-ring provided in the kit. Install O-ring on the thermistor. See Figure 74.

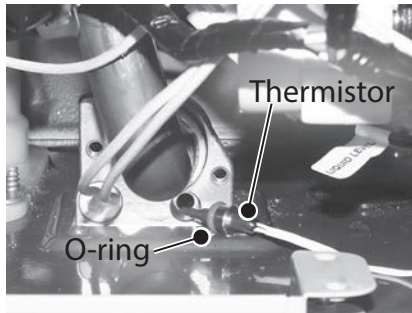

Figure 74 - Thermistor O-ring location

19 Install the new water outlet thermistor in the water heater. See Figure 72. Secure with the screws and C Clip removed in **Step 14**.

NOTICE: DO NOT use the metal clip provided in the kit for this thermistor. The metal clip may be discarded.

20 Proceed to **Step 28** to leak check the water and return water heater to operation.

Removing Heat Exchanger Outlet Thermistor

21 Locate the heat exchanger outlet thermistor as shown in Figure 75.

22 Locate the screw securing the heat exchanger outlet thermistor. See Figure 75. Use a Phillips screwdriver to remove the screw and the metal clip. Remove screw and place aside in a safe place for reinstallation. Discard metal clip.

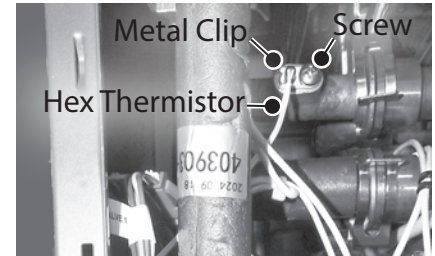

Figure 75 - Outlet thermistor location

Disconnect the thermistor wiring harness marked "HEX". See Figure 76.

NOTICE: Press in the location shown in Figure 76 to disconnect the wiring harness.



Figure 76 - Wiring harness location

23 Use a mini pick or hook to remove the heat exchanger outlet thermistor O-ring seated in the HEX outlet base. Dispose of the O-ring properly.

24 Dispose of the old thermistor properly.

SERVICE (ELECTRONIC & WIRING COMPONENTS)

Replacing Heat Exchanger Outlet Thermistor

- 25 Locate the new thermistor, O-ring and metal clip provided in the kit. Install O-ring on the thermistor. See Figure 77.

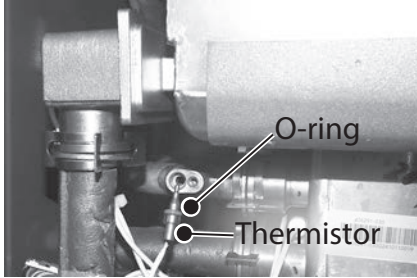

Figure 77 - Thermistor O-ring location

- 26 Install the new heat exchanger outlet thermistor in the water heater. See Figure 75. Secure with the new metal clip and the screw removed in **Step 22**.

- 27 Proceed to **Step 28** to leak check the water and return water heater to operation.

Checking for Water Leaks

- 28 Turn **ON** the cold water supply to the water heater at the cold inlet valve. The system will fully pressurize and any leaks at water connections will be apparent. Correct any leaks immediately and dry water heater cabinet with a rag.

Returning Water Heater to Operation

- 29 Replace the cabinet cover and secure with the screws previously removed in **Step 12**.
- 30 Turn **ON** the gas supply to the water heater at the manual gas shut off valve.
- 31 Restore power to the water heater. The water heater is now ready for operation.

SERVICE (COMBUSTION COMPONENTS)

Gas Inlet Connector

Kit 100390061 Contains:

- Gas Inlet Connector
- (2x) O-Rings (25.7 x 3.5)
- Kit Instructions

IMPORTANT: Use only factory authorized replacement parts. **DO NOT USE ELECTRIC SCREWDRIVERS OR DRILLS, HAND TIGHTEN ALL SCREWS TO PREVENT OVER TIGHTENING.** If you lack the necessary skills to properly perform the installation, you should not proceed, but get help from a qualified service technician.

Tools and Materials Required:

- Phillips Screwdriver
- Bucket or Pan
- Towel or Rag
- Safety Gloves

WARNING!

This kit shall be installed by a qualified service agency in accordance with the manufacturer's instructions and all applicable codes and requirements of the authority having jurisdiction. The information in these instructions must be followed to minimize the risk of fire or explosion or to prevent property damage, personal injury or death. The qualified service agency is responsible for the proper installation of this kit.

Preparing Water Heater for Service

- 1 Disconnect power to the water heater by unplugging it or by turning off the circuit at the breaker box, as appropriate. The power button on the water heater and remote **DOES NOT** disconnect power to the water heater. You must physically disconnect power to the water heater.
- 2 Shut **OFF** the gas supply to the water heater at the manual gas shut off valve.

Accessing Water Heater Components

- 3 Locate the two (2) screws at the bottom of the cabinet cover. Use a Phillips screwdriver to remove the screws. Place screws aside in a safe place for reinstallation.
- 4 Lift cover up and away from cabinet to gain access to the water heater's internal components.

Removing the Gas Inlet Connector

- 5 Disconnect the gas line from the gas inlet connector.
- 6 Locate the gas inlet connector on the bottom side of the water heater. See Figure 78. Remove the four screws securing the gas inlet connector to the water heater cabinet. Place screws aside in a safe place for reinstallation.

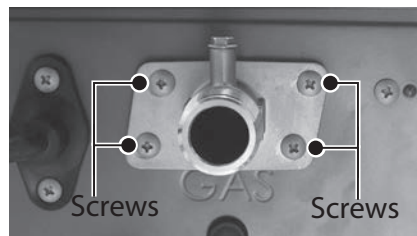

Figure 78 - Gas inlet connector location and screws

- 7 Locate the set screw on the bottom flange of the gas valve. Remove set screw and carefully disconnect gas inlet connector from gas valve. Place set screw aside in a safe place for reinstallation. See Figure 79.

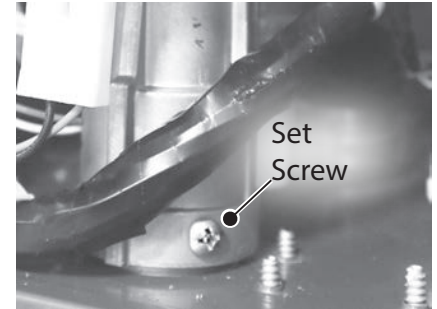

Figure 79 - Gas valve set screw

Replacing the Gas Inlet Connector

- 8 Locate the two gas inlet connector O-rings and new gas inlet connector provided in the kit. Install new O-rings to the new gas inlet connector. See Figure 80.

NOTICE: Handle with care and verify lubricant has been applied to O-ring and O-ring is not dirty or damaged.

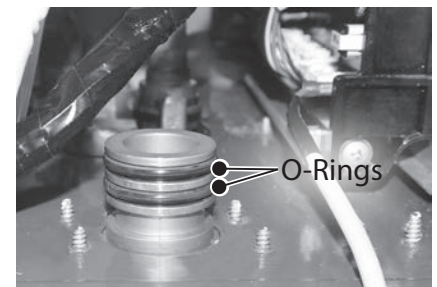

Figure 80 - Gas inlet connector O-rings

- 9 Install gas inlet connector to gas valve and secure with set screw previously removed in **Step 7**.
- 10 Secure gas inlet connector to bottom of water heater cabinet with the four screws previously removed in **Step 6**.

SERVICE (COMBUSTION COMPONENTS)

11 Reconnect the gas line to the gas inlet connector. Use an approved thread sealant tape or pipe dope when making the connection.

Checking for Gas Leaks

12 Place a towel or rag around the proportional valve component of the gas valve to keep it dry when checking for leaks.

NOTICE: DO NOT apply liquids to any of the electrical connections when checking for gas leaks.

13 Turn **ON** the gas supply to the water heater at the manual gas shutoff valve.

14 Restore power to the water heater.

15 Open all hot water fixtures in the house. This will initiate the call for heat at the water heater.

16 Check for leaks around the base of the gas valve and the gas inlet connector. Use a small, soft-bristled brush to apply a hand dishwashing soap and water mixture (1 part soap to 15 parts water) or children's soap bubbles around the gas valve connections. If any leaks are detected (which will appear as small bubbles), resecure the connections and recheck for leaks.

17 Once no leaks have been confirmed, remove towel or rag from gas valve and electrical connections.

18 Close all hot water fixtures in the house once the check is complete.

Returning Water Heater to Operation

19 Replace the cabinet cover and secure with the screws previously removed in **Step 3**.

The water heater is now ready for operation.

SERVICE (COMBUSTION COMPONENTS)

Gas Valve

Kit 100390062 Contains:

- Gas Valve
- (3x) O-rings (25.7 x 3.5)
- Gas Manifold Gasket
- Kit Instructions

IMPORTANT: Use only factory authorized replacement parts. **DO NOT USE ELECTRIC SCREWDRIVERS OR DRILLS, HAND TIGHTEN ALL SCREWS TO PREVENT OVER TIGHTENING.** If you lack the necessary skills to properly perform the installation, you should not proceed, but get help from a qualified service technician.

Tools and Materials Required:

- Phillips Screwdriver
- Safety Gloves

WARNING!

This kit shall be installed by a qualified service agency in accordance with the manufacturer's instructions and all applicable codes and requirements of the authority having jurisdiction. The information in these instructions must be followed to minimize the risk of fire or explosion or to prevent property damage, personal injury or death. The qualified service agency is responsible for the proper installation of this kit.

SERVICE

Preparing Water Heater for Service

- 1 Disconnect power to the water heater by unplugging it or by turning off the circuit at the breaker box, as appropriate. The power button on the water heater and remote **DOES NOT** disconnect power to the water heater. You must physically disconnect power to the water heater.
- 2 Shut **OFF** the gas supply to the water heater at the manual gas shut off valve.
- 3 Locate the two screws at the bottom of the cabinet cover. Use a Phillips screwdriver to remove the screws. Place screws aside in a safe place for reinstallation.
- 4 Lift cover up and away from cabinet to gain access to the water heater's internal components.

Disconnecting Flame Sensor Wire

- 5 Locate flame sensor wire attached to burner assembly. Disconnect wire and place aside for easy access to the gas manifold. See Figure 81.

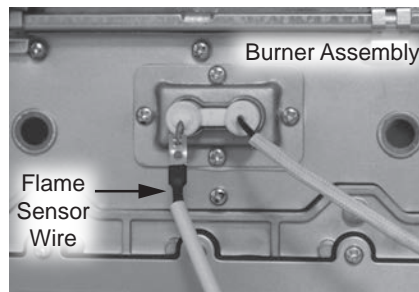

Figure 81 - Removing flame sensor wire

Disconnecting UIM and Bracket

- 6 Locate both green ground wires attached to gas manifold cover. Remove the two screws securing the green ground wires and place them aside in a safe place for reinstallation. See Figure 82.

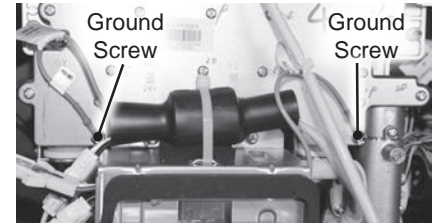

Figure 82 - Removing green ground wires

- 7 Locate the User Interface Module (UIM) and bracket. Remove the four screws securing bracket to the water heater. Place screws aside in a safe place for reinstallation. See Figure 83.

NOTICE: UIM, bracket and wiring do not need to be disconnected. Allow UIM and bracket to rest below water heater.

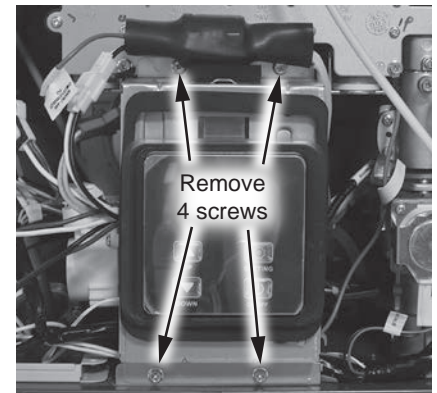

Figure 83 - Removing UIM and bracket screws

SERVICE (COMBUSTION COMPONENTS)

Removing the Ignitor Assembly

- 8 Locate the ignitor assembly on the right side of the water heater. See Figure 84.
- 9 Disconnect the ignitor wire from the ignitor assembly. See Figure 84.
- 10 Remove the two screws securing the ignitor assembly and bracket to the gas manifold. Place screws aside in a safe place for reinstallation. See Figure 84.

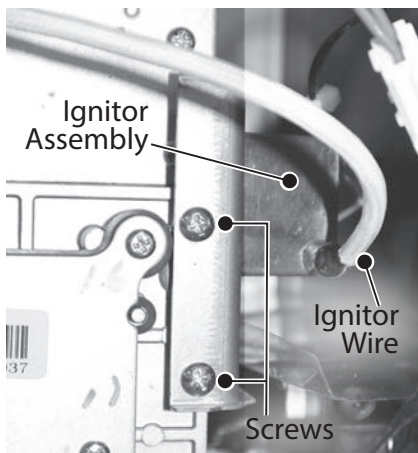

Figure 84 - Ignitor assembly location

- 11 Disconnect the two spade terminal connections at the back of ignitor and remove ignitor assembly and bracket from water heater. See Figure 85.

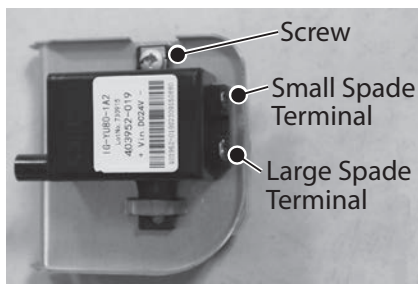

Figure 85 - Disconnecting ignitor assembly

Removing Gas Manifold

- 12 Locate the gas manifold wire harness and disconnect it. See Figure 86.

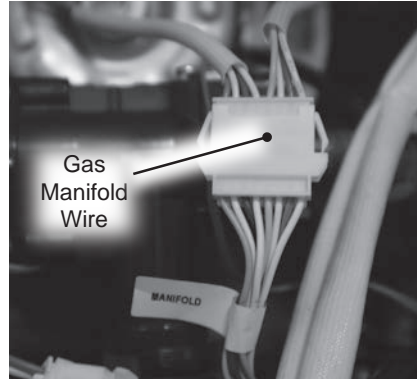

Figure 86 - Disconnecting gas manifold wire

- 13 Locate and remove the four screws securing the gas valve to the gas manifold. Place screws aside in a safe place for reinstallation. See Figure 87.

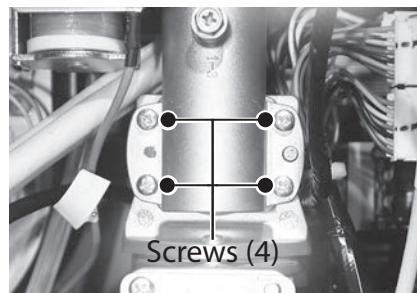

Figure 87 - Remove gas valve screws

- 14 Locate the eight screws securing the gas manifold to the burner assembly. Remove screws and place aside in a safe place for reinstallation. See Figure 88.

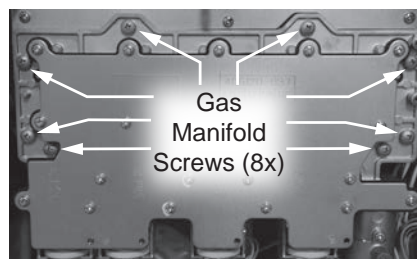

Figure 88 - Removing gas manifold screws

- 15 Remove the manifold and place aside for reinstallation.

Removing the Gas Valve

- 16 Locate the gas valve at the bottom right side of the water heater. See Figure 89.

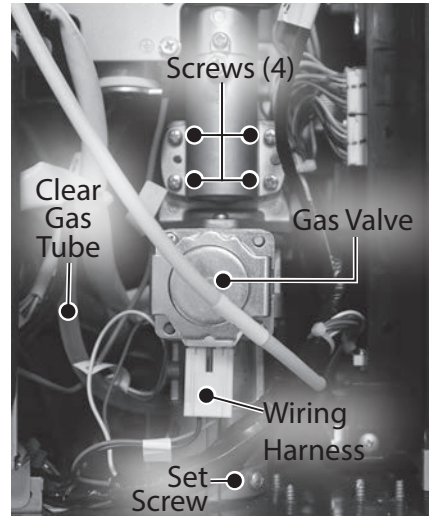

Figure 89 - Gas valve location and connections

- 17 Remove the clear gas tube from the gas valve and place aside. See Figure 87.

- 18 Disconnect the two wire harnesses connected to the gas valve. See Figure 87. The wires are labeled:

- "Gas Valve"
- "Proportional Valve"

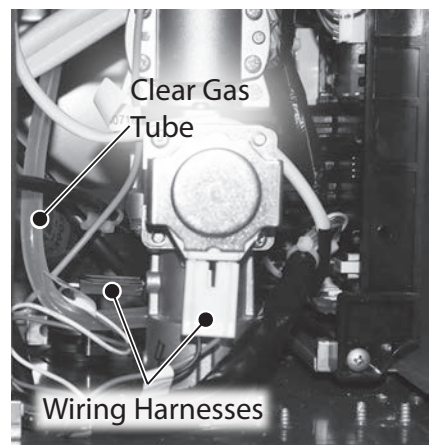

Figure 90 - Gas tube and wire harnesses

SERVICE (COMBUSTION COMPONENTS)

- 19** Locate the set screw on the bottom flange of the gas valve. Remove set screw and place aside in a safe place for reinstallation. See Figure 91.

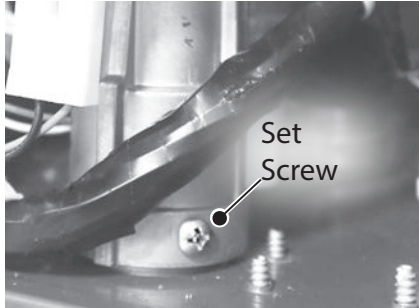

Figure 91 - Gas valve set screw

- 20** Remove old gas valve and dispose of properly.

Replacing the Gas Valve

- 21** Locate the new gas valve and gas valve O-rings (3x) provided in the kit. Install one new O-ring to gas valve as shown in Figure 92.

NOTICE: Handle with care and verify lubricant has been applied to O-ring and O-ring is not dirty or damaged.

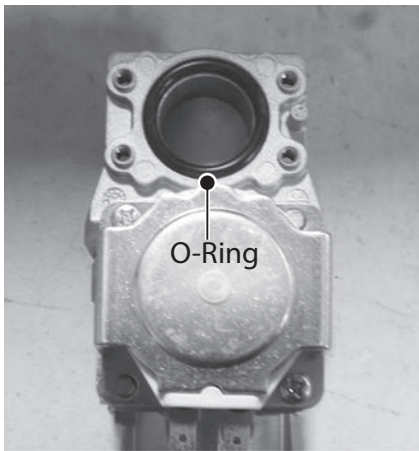

Figure 92 - O-ring replacement (one O-ring)

- 22** Locate the gas connector O-rings and remove them. Install two new O-rings to gas connector. See Figure 93.

NOTICE: Handle with care and verify lubricant has been applied to O-ring and O-ring is not dirty or damaged.

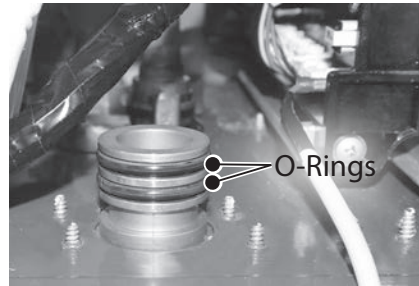

Figure 93 - Gas connector O-rings

- 23** Before installing new gas valve to water heater, verify rubber boot is properly inserted into bottom of water heater cabinet as shown in Figure 94.

NOTICE: The proportional valve component of the gas valve will rest on top of this rubber boot.

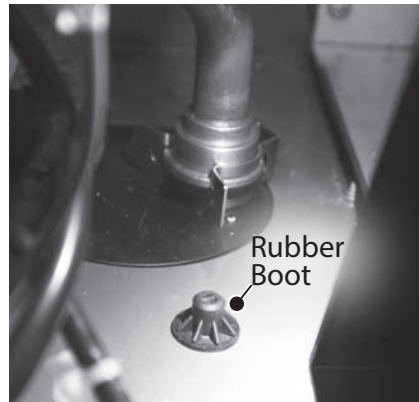

Figure 94 - Verify rubber boot placement

- 24** Connect the clear gas tube to the new gas valve previously disconnected in **Step 17**.
- 25** Connect the two wiring harnesses to the new gas valve previously disconnected in **Step 18**.
- 26** Secure gas valve using the set screw previously removed in **Step 19**.

Installing Gas Manifold

- 27** Locate the gas manifold gasket provided in the kit. Use a plastic scraper to gently scrape old insulation gasket clean from gas manifold. Confirm assembly surface is free of any debris or leftover insulation. Install new gasket to gas manifold. See Figure 95.

IMPORTANT! DO NOT gouge or damage assembly surface when removing insulation gasket.

NOTICE: Handle with care and verify gasket is not dirty or damaged.

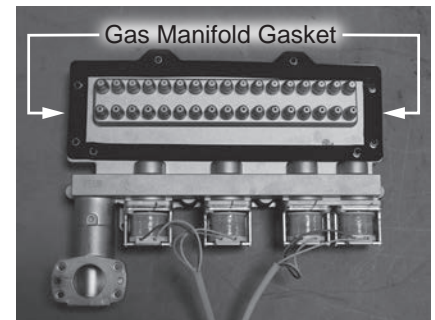

Figure 95 - Replacing gas manifold gasket

- 28** Reinstall the gas manifold to the burner assembly using the eight screws previously removed in **Step 14**.

NOTICE: Inspect burner assembly surface for debris and clean surface if necessary. Confirm new gas manifold gasket is free of debris before installing to burner assembly.

- 29** Locate the four screws previously removed in **Step 13**, and secure the gas manifold to the gas valve. See Figure 87.

SERVICE (COMBUSTION COMPONENTS)

Installing the Ignitor Assembly

- 30 Locate the ignitor assembly. Connect the two spade terminal connections to the ignitor assembly. Confirm electrical connections are tight.

NOTICE: There is one large and one small spade terminal connection.

- 31 Mount the ignitor assembly to the gas manifold and secure with the two screws previously removed in **Step 10**.
- 32 Reconnect the ignitor wire previously removed in **Step 9**.

Installing UIM and Bracket

- 33 Secure the User Interface Module (UIM) and bracket to water heater with the four screws previously removed in **Step 7**. Confirm all electrical connections are snug and properly routed behind bracket.

Connecting Flame Sensor Wire

- 34 Locate the flame sensor previously disconnected from burner assembly in **Step 5**. Connect flame sensor wire. See Figure 81.

Checking for Gas Leaks

IMPORTANT! DO NOT apply liquids to any of the electrical connections when checking for gas leaks. Use a towel or rag to protect any electrical components.

- 35 Turn **ON** the gas supply to the water heater at the manual gas shut off valve. Restore power to the water heater. Open all hot water fixtures in the house. This will initiate the call for heat at the water heater.
- 36 Use code approved methods to check for leaks around all gas connection points. If any leaks are detected, resecure components and recheck for leaks.
- 37 Close all hot water fixtures in the house once the check is complete.

Returning Water Heater to Operation

- 38 Replace the cabinet cover and secure with the two screws previously removed in **Step 3**.
- 39 The water heater is now ready for operation.

SERVICE (COMBUSTION COMPONENTS)

Fan Assembly

Kit 100390065 Contains:

- Fan Assembly
- Rubber Stopper
- Metal Clip
- O-Ring (3.8 x 1.9)
- Kit Instructions

IMPORTANT: Use only factory authorized replacement parts. **DO NOT USE ELECTRIC SCREWDRIVERS OR DRILLS, HAND TIGHTEN ALL SCREWS TO PREVENT OVER TIGHTENING.** If you lack the necessary skills to properly perform the installation, you should not proceed, but get help from a qualified service technician.

Tools and Materials Required:

- 12" Magnetized Phillips Screwdriver
- Safety Gloves

Preparing Water Heater for Service

- 1 Disconnect power to the water heater by unplugging it or by turning off the circuit at the breaker box, as appropriate. The power button on the water heater and remote **DOES NOT** disconnect power to the water heater. You must physically disconnect power to the water heater.
- 2 Shut **OFF** the gas supply to the water heater at the manual gas shut off valve.
- 3 Shut **OFF** the cold water supply to the water heater at the cold inlet valve.
- 4 Open all hot water fixtures in the house. When the residual water flow has ceased, close all hot water fixtures. This will depressurize the water heater.

Draining the Water Heater

- 5 Drain the X3®/Bypass Cartridge. Place a bucket or pan underneath cartridge to collect water during removal.
- 6 Locate the three (3) screws securing the X3®/Bypass cartridge as shown in Figure 96. Remove the (A) M4-12mm screw and the two (B) M4-25mm screws from cartridge. Place screws aside in a safe place for reinstallation.

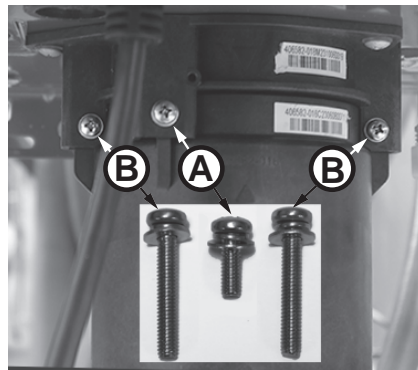

Figure 96 - Identify cartridge screws

- 7 Pull down to remove the cartridge from the water heater. Wait a few minutes to ensure all water has completely drained.
- 8 Locate and remove the inlet filter as shown in Figure 97 to drain any residual water left in the system. Place a bucket or pan underneath inlet filter to collect water during removal.

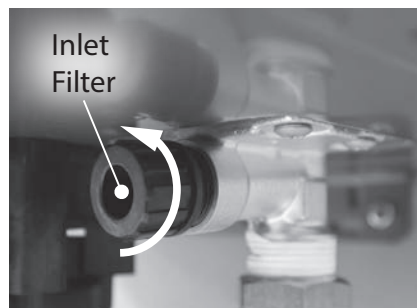

Figure 97 - Removing the inlet filter

- 9 Once the water heater has been adequately drained, reinstall inlet filter to water heater and tighten by hand. Confirm inlet filter is secured to water heater.
 - 10 Reinstall the cartridge to the water heater. Locate the screws previously removed in **Step 6**. Insert and snug all three (3) screws by hand.
- NOTICE:** The X3® cartridge is keyed to only install in one direction. Align the ▲ on the cartridge with the ▼ on the manifold (the arrows will be facing the backside of the water heater). When inserting the cartridge, push up until the screw holes align. Some resistance is normal. The bypass cartridge is not keyed and will install in either direction.
- 11 Use a screwdriver to tighten the two (B) screws first and lastly tighten screw (A). **DO NOT** use a drill or impact driver to tighten the screws.

Accessing Water Heater Components

- 12 Locate the two (2) screws at the bottom of the cabinet cover. Use a Phillips screwdriver to remove the screws. Place screws aside in a safe place for reinstallation.
- 13 Lift cover up and away from cabinet to gain access to the water heater's internal components.

Disconnecting UIM and Bracket

- 14 Locate the User Interface Module (UIM) and bracket. Remove the four screws securing bracket to the water heater. Place screws aside in a safe place for reinstallation. See Figure 98.

NOTICE: UIM, bracket and wiring do not need to be disconnected. Allow UIM and bracket to rest below water heater for easy access to fan assembly.

SERVICE (COMBUSTION COMPONENTS)

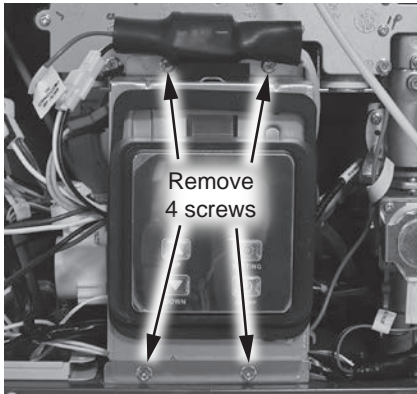

Figure 98 - Removing UIM and bracket screws

Disconnecting Flow Control Valve

- 15 Locate the flow control valve in the water heater as shown in Figure 99.

NOTICE: Some components and wiring have been removed for clarity.

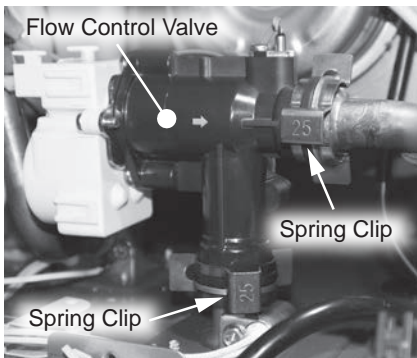

Figure 99 - Locating and disconnecting flow control valve

⚠ CAUTION! Water may still be present in the valve assembly. Place a rag under the valve connection points to prevent water from escaping into the water heater cabinet.

- 16 Remove the two spring clips (size 25) securing the flow control valve to the piping system. Place the spring clips aside in a safe place for reinstallation. See Figure 99.

- 17 Remove the flow control valve from the piping system and allow it to rest near the bottom of the water heater for easy access to fan assembly.

Disconnecting Fan Assembly from Printed Circuit Board (PCB)

- 18 Locate the Printed Circuit Board (PCB) on the right side of the water heater. Use a Phillips screwdriver to remove the two screws securing the PCB. Place screws aside in a safe place for reinstallation. See Figure 100.

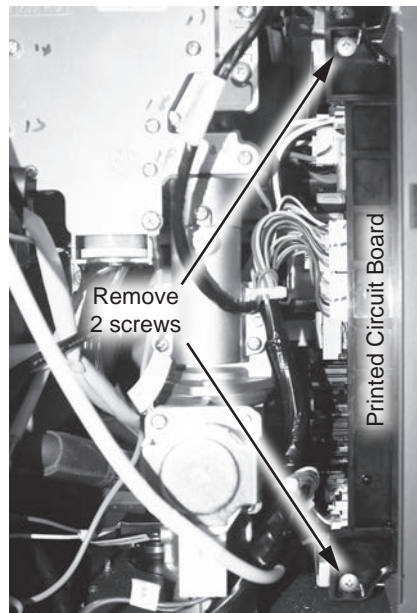

Figure 100 - Removing PCB screws

- 19 Gently slide PCB out from water heater.
- 20 Using Figure 101 as reference, disconnect the fan assembly wiring harness from PCB.

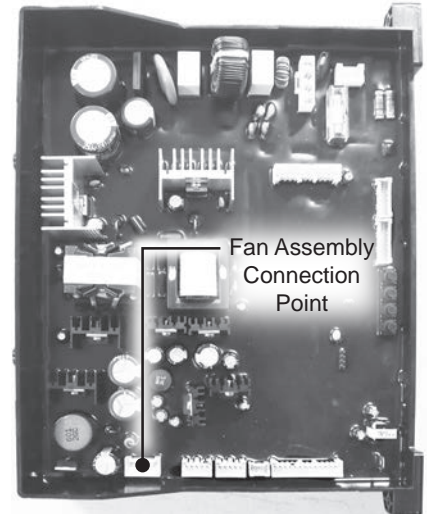

Figure 101 - Disconnecting fan assembly from PCB

Removing Fan Assembly

- 21 Locate the five screws securing the fan assembly to the burner. There are two screws securing the front of the fan assembly (A), two screws securing the back of the fan assembly (B), and one screw securing the fan bracket (C) to the water heater cabinet. See Figure 102 & Figure 103.

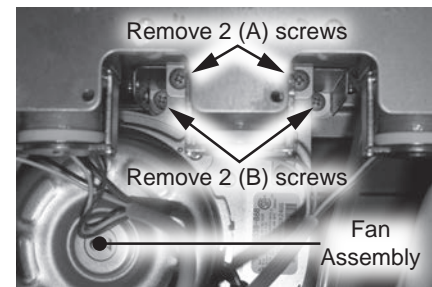

Figure 102 - Fan screw location (A & B)

SERVICE (COMBUSTION COMPONENTS)

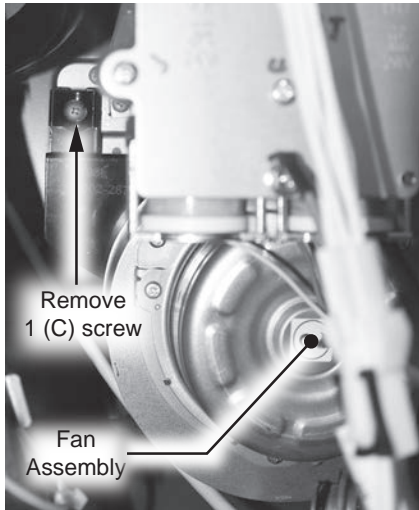

Figure 103 - Fan screw location (C)

- 22 Remove all screws and place them aside in a safe place for reinstallation.
- 23 Remove fan assembly from burner. Rotate fan assembly 90° counterclockwise and remove fan assembly from water heater.

NOTICE: For easy removal, guide the fan around the left side of the inlet manifold as shown in Figure 104.

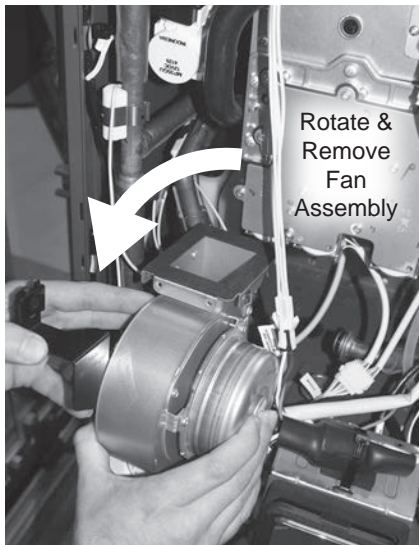

Figure 104 - Rotate and remove fan assembly

Preparing New Fan Assembly

- 24 Locate the new fan assembly provided in the kit.

IMPORTANT! Note the fan designation number provided on the label located in the center of both the old and new fan assemblies. This information will be used later to properly configure the water heater. See Figure 105.

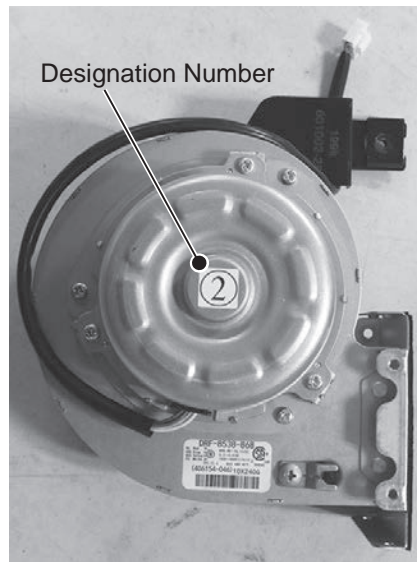

Figure 105 - Fan designation number

- 25 Remove the three screws securing the fan bracket to the old fan assembly. Place screws aside in a safe place for reinstallation. See Figure 106.

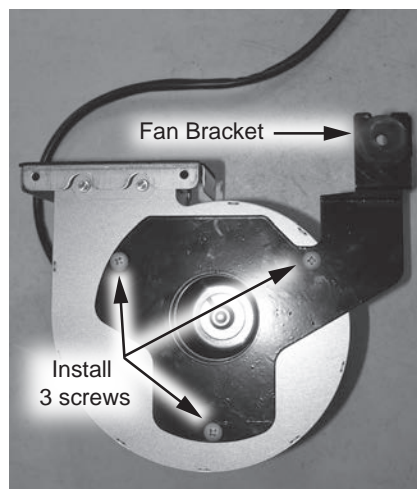

Figure 106 - Install fan bracket

- 26 Secure the new fan bracket to the new fan assembly using the screws removed **Step 25**. See Figure 106.

- 27 Remove the screw securing the metal clip and stopper to the old fan assembly. Place screw in a safe place for reinstallation. See Figure 107.

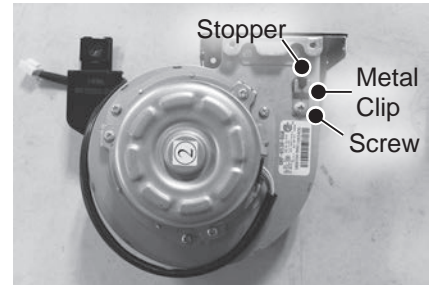

Figure 107 - Stopper installation

- 28 Using the new metal clip, secure the new stopper to the new fan assembly with the screw removed in **Step 27**. See Figure 107. Dispose of old fan assembly properly.

Installing New Fan Assembly

- 29 Rotate new fan assembly 90° counterclockwise so the fan outlet is facing the water heater. Insert fan assembly into water heater using the same method as outlined in **Step 23** in reverse order. See Figure 104.

- 30 Install fan assembly outlet firmly into burner. Verify all screw hole locations align properly. Secure fan assembly with the five screws previously removed in **Step 22**, starting with the bracket screw (C) to help stabilize the fan assembly.

- 31 Guide fan assembly wiring harness behind gas valve. Using Figure 101 as reference, connect fan assembly wiring harness to PCB.

NOTICE: The O-ring is not used to service this model and can be discarded.

SERVICE (COMBUSTION COMPONENTS)

Installing Printed Circuit Board (PCB)

32 With the fan assembly wiring harness secured, slide PCB back into position and secure PCB to mounting brackets with the two screws previously removed in **Step 18**.

Installing Flow Control Valve

33 Carefully install flow control valve to pipe connections. Confirm wiring connections are secure.

34 Locate the two (2) spring clips previously removed in **Step 16**. Install spring clips to flow control valve, securing it to piping connections. See Figure 99. Verify water connections are tight and will not leak.

Installing UIM and Bracket

35 Secure the User Interface Module (UIM) and bracket to water heater with the four screws previously removed in **Step 14**. Confirm all electrical connections are snug and properly routed behind bracket.

Checking for Water Leaks

36 Turn **ON** the cold water supply to the water heater at the cold inlet valve. The system will fully pressurize and any leaks at water connections will be apparent. Correct any leaks immediately and dry water heater cabinet with a rag.

Returning Water Heater to Operation

37 Replace the cabinet cover and secure with the screws previously removed in **Step 12**.

38 Turn **ON** the gas supply to the water heater at the manual gas shut off valve.

39 Restore power to the water heater.

40 If the old fan designation number recorded in **Step 24** matches the new fan designation number, the water heater is now ready for operation.

Proceed to the following section to configure water heater for new fan designation number.

Configuring Water Heater for New Fan Designation Number

Your water heater must be configured to operate as intended with the new fan assembly. Follow the procedure below to access C Mode at the UIM and properly configure water heater.

41 Press and hold the "**UP**" button and the "**SETTING**" button for 5 seconds to access C Mode.

42 Press the "**UP**" button or the "**DOWN**" button to search for C code **C04**.

43 Press the "**SETTING**" button and adjust the value of **C04** using the "**UP**" and "**DOWN**" buttons to match the fan designation number on the new fan assembly recorded in **Step 24**. See Figure 105 as reference. The value will flash.

44 Press the "**SETTING**" button again to confirm the new value selected is correct.

45 Press and hold the "**UP**" button and the "**DOWN**" button for 5 seconds to return the display to normal operation.

46 To cycle power, disconnect power to the water heater by unplugging it or by turning off the circuit at the breaker box, as appropriate.

47 Restore power and press the "**POWER**" button to turn the water heater on again.

The water heater is now ready for operation.

SERVICE (COMBUSTION COMPONENTS)

Gas Manifold

Kit 100390063 Contains:

- Gas Manifold
- Gas Valve O-ring (25.7 x 3.5)
- Kit Instructions

IMPORTANT: Use only factory authorized replacement parts. **DO NOT USE ELECTRIC SCREWDRIVERS OR DRILLS, HAND TIGHTEN ALL SCREWS TO PREVENT OVERTIGHTENING.** If you lack the necessary skills to properly perform the installation, you should not proceed, but get help from a qualified service technician.

Tools and Materials Required:

- 12" Magnetized Phillips Screwdriver
- Safety Gloves

WARNING!

This kit shall be installed by a qualified service agency in accordance with the manufacturer's instructions and all applicable codes and requirements of the authority having jurisdiction. The information in these instructions must be followed to minimize the risk of fire or explosion or to prevent property damage, personal injury or death. The qualified service agency is responsible for the proper installation of this kit.

Preparing Water Heater for Service

- 1 Disconnect power to the water heater by unplugging it or by turning off the circuit at the breaker box, as appropriate. The power button on the water heater and remote **DOES NOT** disconnect power to the water heater. You must physically disconnect power to the water heater.
- 2 Shut **OFF** the gas supply to the water heater at the manual gas shut off valve.

Accessing Water Heater Components

- 3 Locate the two (2) screws at the bottom of the cabinet cover. Use a Phillips screwdriver to remove the screws. Place screws aside in a safe place for reinstallation.
- 4 Lift cover up and away from cabinet to gain access to the water heater's internal components.

Disconnecting Flame Sensor Wire

- 5 Locate flame sensor wire attached to burner assembly. Disconnect wire and place aside for easy access to the gas manifold. See Figure 108.

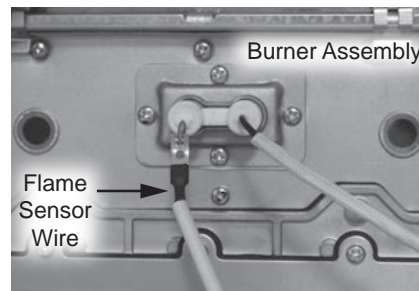

Figure 108 - Removing flame sensor wire

Disconnecting UIM and Bracket

- 6 Locate both green ground wires attached to gas manifold cover. Remove the two screws securing the green ground wires and place them aside in a safe place for reinstallation. See Figure 109.

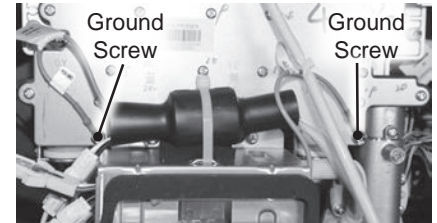

Figure 109 - Removing green ground wires

- 7 Locate the User Interface Module (UIM) and bracket. Remove the four screws securing bracket to the water heater. Place screws aside in a safe place for reinstallation. See Figure 110.

NOTICE: UIM, bracket and wiring do not need to be disconnected. Allow UIM and bracket to rest below water heater for easy access to gas manifold.

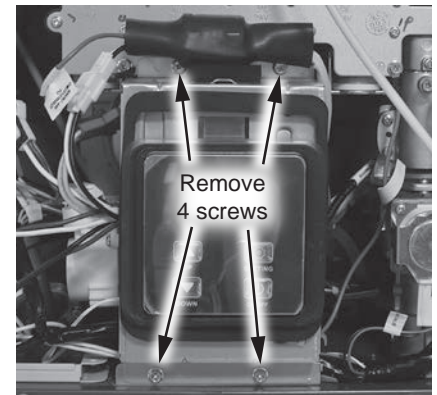

Figure 110 - Removing UIM and bracket screws

SERVICE (COMBUSTION COMPONENTS)

Removing the Ignitor Assembly

- 8 Locate the ignitor assembly on the right side of the water heater. See Figure 111.
- 9 Disconnect the ignitor wire from the ignitor assembly. See Figure 111.
- 10 Remove the two screws securing the ignitor assembly and bracket to the gas manifold. Place screws aside in a safe place for reinstallation. See Figure 111.

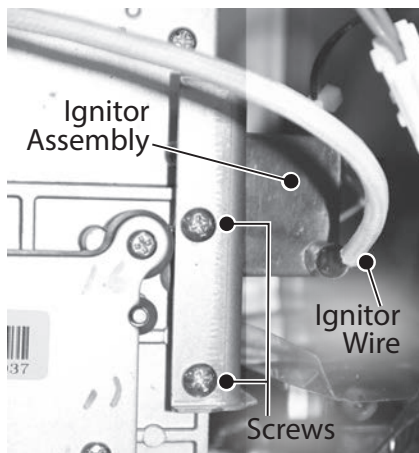

Figure 111 - Ignitor assembly location

- 11 Disconnect the two spade terminal connections at the back of ignitor and remove ignitor assembly and bracket from water heater. See Figure 112.

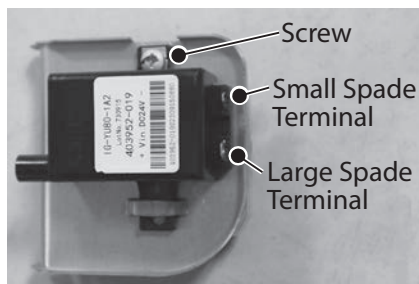

Figure 112 - Disconnecting ignitor assembly

Removing Gas Manifold

- 12 Locate the gas manifold wire harness and disconnect it. See Figure 113.

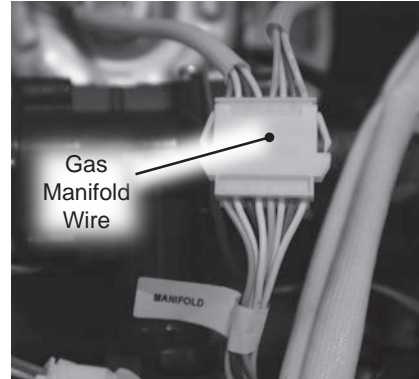

Figure 113 - Disconnecting gas manifold wire

- 13 Locate and remove the four screws securing the gas valve to the gas manifold. Place screws aside in a safe place for reinstallation. See Figure 114.

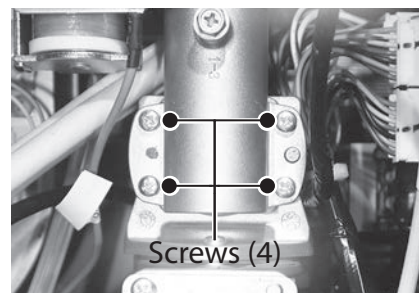

Figure 114 - Remove gas valve screws

- 14 Locate the eight screws securing the gas manifold to the burner assembly. Remove screws and place aside in a safe place for reinstallation. See Figure 115.

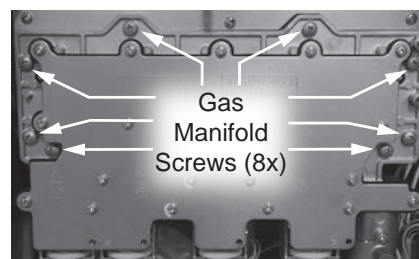

Figure 115 - Removing gas manifold screws

- 15 Remove gas manifold and dispose of properly.

Installing New Gas Manifold

- 16 Locate the gas valve O-ring (25.7 x 3.5) provided in the kit. Remove the old O-ring from gas valve and install new O-ring as shown in Figure 116.

NOTICE: Handle with care and verify lubricant has been applied to O-ring and O-ring is not dirty or damaged.



Figure 116 - O-ring replacement

- 17 Locate new gas manifold provided in the kit and install it to burner assembly using the eight screws previously removed in **Step 14**.

NOTICE: Inspect burner assembly surface for debris and clean surface if necessary. Confirm new gas manifold gasket is free of debris before installing to burner assembly.

- 18 Locate the four screws previously removed in **Step 13** and secure the gas manifold to the gas valve. Figure 114.

- 19 Locate the gas manifold wire harness and connect it. See Figure 113.

SERVICE (COMBUSTION COMPONENTS)

Installing the Ignitor Assembly

20 Locate the ignitor assembly. Connect the two spade terminal connections to the ignitor assembly. Confirm electrical connections are tight.

NOTICE: There is one large and one small spade terminal connection.

21 Mount the ignitor assembly to the gas manifold and secure with the two screws previously removed in **Step 10**.

22 Reconnect the ignitor wire previously removed in **Step 9**.

Installing UIM and Bracket

23 Secure the User Interface Module (UIM) and bracket to water heater with the four screws previously removed in **Step 7**. Confirm all electrical connections are snug and properly routed behind bracket.

Connecting Flame Sensor Wire

24 Locate the flame sensor previously disconnected from burner assembly in **Step 5**. Connect flame sensor wire. See Figure 108.

Checking for Gas Leaks

IMPORTANT! DO NOT apply liquids to any of the electrical connections when checking for gas leaks. Use a towel or rag to protect any electrical components.

25 Turn **ON** the gas supply to the water heater at the manual gas shut off valve. Restore power to the water heater. Open all hot water fixtures in the house. This will initiate the call for heat at the water heater.

26 Use code approved methods to check for leaks around all gas connection points. If any leaks are detected, resecure components and recheck for leaks.

27 Close all hot water fixtures in the house once the check is complete.

Returning Water Heater to Operation

28 Replace the cabinet cover and secure with the two screws previously removed in **Step 3**.

29 The water heater is now ready for operation.

SERVICE (COMBUSTION COMPONENTS)

Ignitor Rod & Flame Sensor Rod Assembly

Kit 100390068 Contains:

- Ignitor Rod and Flame Sensor Rod Assembly
- Gasket
- Kit Instructions

IMPORTANT: Use only factory authorized replacement parts. **DO NOT USE ELECTRIC SCREWDRIVERS OR DRILLS, HAND TIGHTEN ALL SCREWS TO PREVENT OVER TIGHTENING.** If you lack the necessary skills to properly perform the installation, you should not proceed, but get help from a qualified service technician.

Tools and Materials Required:

- Phillips Screwdriver
- Safety Gloves

WARNING!

This kit shall be installed by a qualified service agency in accordance with the manufacturer's instructions and all applicable codes and requirements of the authority having jurisdiction. The information in these instructions must be followed to minimize the risk of fire or explosion or to prevent property damage, personal injury or death. The qualified service agency is responsible for the proper installation of this kit.

Preparing Water Heater for Service

1 Disconnect power to the water heater by unplugging it or by turning off the circuit at the breaker box, as appropriate. The power button on the water heater and remote **DOES NOT** disconnect power to the water heater. You must physically disconnect power to the water heater.

2 Shut **OFF** the gas supply to the water heater at the manual gas shut off valve.

Accessing Water Heater Components

3 Locate the two screws at the bottom of the cabinet cover. Use a Phillips screwdriver to remove the screws. Place screws aside in a safe place for reinstallation.

4 Lift cover up and away from cabinet to gain access to the water heater's internal components.

Removing the Ignitor Rod and Flame Sensor Rod Assembly

5 Disconnect flame sensor wire from the assembly. See Figure 117.

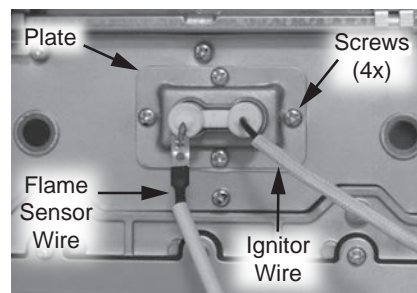

Figure 117 - Ignitor rod and flame sensor rod assembly

6 Disconnect ignitor wire from ignitor assembly. See Figure 118.

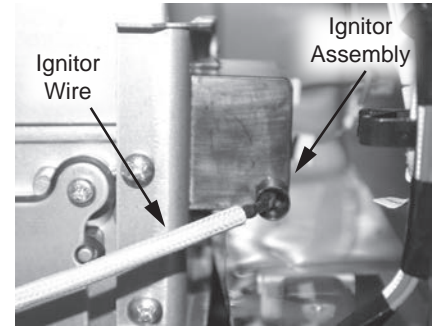

Figure 118 - Disconnecting ignitor wire

7 Locate the four screws securing the plate to the burner assembly. Remove the screws and place them aside in a safe place for reinstallation. See Figure 118.

8 Remove the ignitor rod and flame sensor rod assembly from the burner assembly and dispose of properly.

9 Use a plastic scraper to gently scrape old insulation gasket clean from burner assembly. Confirm burner assembly surface is free of any debris or leftover insulation.

IMPORTANT! DO NOT gouge or damage burner assembly surface when removing insulation gasket.

Installing New Ignitor Rod and Flame Sensor Rod Assembly

10 Locate new ignitor rod and flame sensor rod assembly provided in kit. Locate gasket provided in kit. Place gasket on back side of ignitor rod and flame sensor rod assembly. Confirm screw hole locations align.

11 Locate the four screws previously removed in **Step 7**. Secure the ignitor rod and flame sensor rod assembly to the burner assembly with the four screws.

SERVICE (COMBUSTION COMPONENTS)

- 12 Reconnect the flame sensor wire and ignitor wire previously removed in **Steps 5 & 6**.

Checking for Gas Leaks

IMPORTANT! DO NOT apply liquids to any of the electrical connections when checking for gas leaks. Use a towel or rag to protect any electrical components.

- 13 Turn **ON** the gas supply to the water heater at the manual gas shut off valve. Restore power to the water heater. Open all hot water fixtures in the house. This will initiate the call for heat at the water heater.
- 14 Use code approved methods to check for leaks around all gas connection points and the ignitor rod and flame sensor rod assembly. If any leaks are detected, resecure components and recheck for leaks.
- 15 Once no leaks have been confirmed, remove towel or rag from electrical connections if necessary.
- 16 Close all hot water fixtures in the house once the check is complete. Proceed to the next section.

Returning Water Heater to Operation

- 17 Replace the cabinet cover and secure with the two screws previously removed in **Step 3**.
- 18 The water heater is now ready for operation.

SERVICE (COMBUSTION COMPONENTS)

Burner Assembly

Kit 100390064 Contains:

- Burner Assembly
- Gas Manifold Gasket
- Gas Valve O-ring (size 25.7 x 3.5)
- Kit Instructions

IMPORTANT: Use only factory authorized replacement parts. **DO NOT USE ELECTRIC SCREWDRIVERS OR DRILLS, HAND TIGHTEN ALL SCREWS TO PREVENT OVER TIGHTENING.** If you lack the necessary skills to properly perform the installation, you should not proceed, but get help from a qualified service technician.

Tools and Materials Required:

- 12" Magnetized Phillips Screwdriver
- Safety Gloves

WARNING!

This kit shall be installed by a qualified service agency in accordance with the manufacturer's instructions and all applicable codes and requirements of the authority having jurisdiction. The information in these instructions must be followed to minimize the risk of fire or explosion or to prevent property damage, personal injury or death. The qualified service agency is responsible for the proper installation of this kit.

Preparing Water Heater for Service

1 Disconnect power to the water heater by unplugging it or by turning off the circuit at the breaker box, as appropriate. The power button on the water heater and remote **DOES NOT** disconnect power to the water heater. You must physically disconnect power to the water heater.

2 Shut **OFF** the gas supply to the water heater at the manual gas shut off valve.

Accessing Water Heater Components

3 Locate the two (2) screws at the bottom of the cabinet cover. Use a Phillips screwdriver to remove the screws. Place screws aside in a safe place for reinstallation.

4 Lift cover up and away from cabinet to gain access to the water heater's internal components.

Disconnecting Flame Sensor Wire

5 Locate flame sensor wire attached to burner assembly. Disconnect wire and place aside for easy access to the gas manifold. See Figure 119.

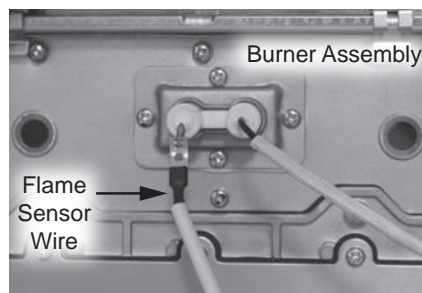

Figure 119 - Removing flame sensor wire

Disconnecting UIM and Bracket

6 Locate both green ground wires attached to gas manifold cover. Remove the two screws securing the green ground wires and place them aside in a safe place for reinstallation. See Figure 120.

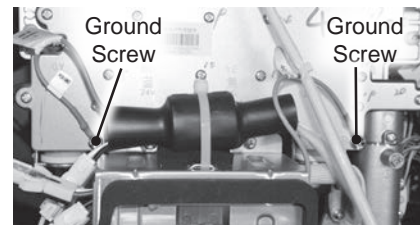

Figure 120 - Removing green ground wires

7 Locate the User Interface Module (UIM) and bracket. Remove the four screws securing bracket to the water heater. Place screws aside in a safe place for reinstallation. See Figure 121.

NOTICE: UIM, bracket and wiring do not need to be disconnected. Allow UIM and bracket to rest below water heater for easy access to gas manifold.

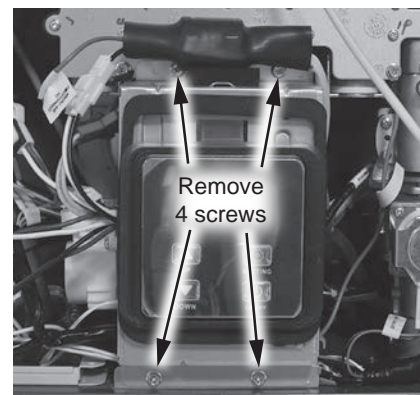

Figure 121 - Removing UIM and bracket screws

SERVICE (COMBUSTION COMPONENTS)

Removing the Ignitor Assembly

- 8 Locate the ignitor assembly on the right side of the water heater. See Figure 122.
- 9 Disconnect the ignitor wire from the ignitor assembly. See Figure 122.
- 10 Remove the two screws securing the ignitor assembly and bracket to the gas manifold. Place screws aside in a safe place for reinstallation. See Figure 122.

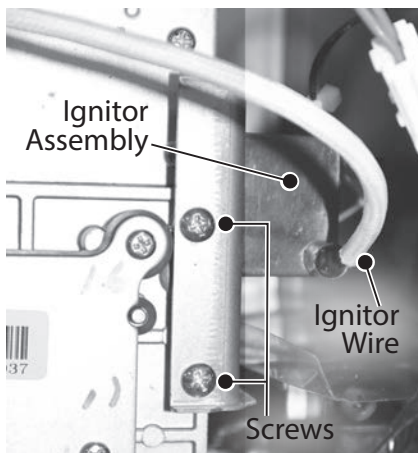

Figure 122 - Ignitor assembly location

- 11 Disconnect the two spade terminal connections at the back of ignitor and remove ignitor assembly and bracket from water heater. See Figure 123.

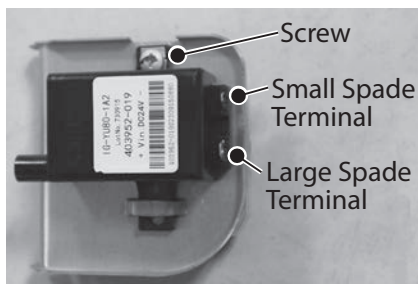

Figure 123 - Disconnecting ignitor assembly

Removing Gas Manifold

- 12 Locate the gas manifold wire harness and disconnect it. See Figure 124.

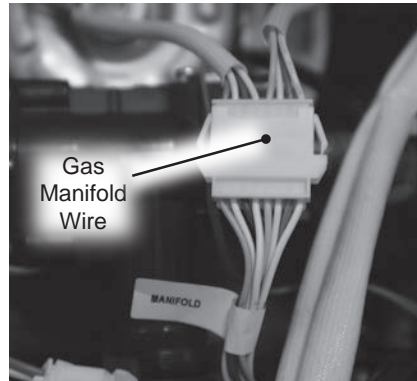

Figure 124 - Disconnecting gas manifold wire

- 13 Locate and remove the four screws securing the gas valve to the gas manifold. Place screws aside in a safe place for reinstallation. See Figure 125.

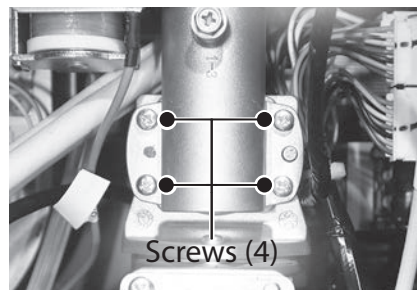

Figure 125 - Remove gas valve screws

- 14 Locate the eight screws securing the gas manifold to the burner assembly. Remove screws and place aside in a safe place for reinstallation. See Figure 126.

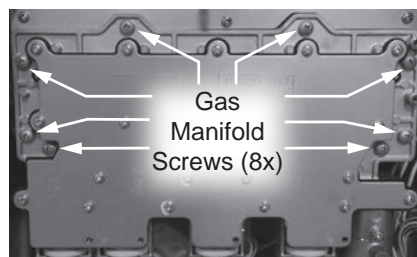

Figure 126 - Removing gas manifold screws

- 15 Remove gas manifold and place it aside in a safe place for reinstallation.

Removing Burner Assembly

- 16 Locate the overhear cutoff fuse (OHCF) above the burner assembly. Remove the two guide clips from the burner assembly routing the OHCF around the primary heat exchanger. See Figure 127.
- 17 Locate the two bottom screws securing the burner assembly to the water heater as shown in Figure 127. Use a 12" magnetized Phillips screwdriver to remove screws. Place screws aside in a safe place for reinstallation.
- 18 Locate the nine top screws securing the burner assembly to the water heater as shown in Figure 127. Use a 12" magnetized Phillips screwdriver to remove screws. Place screws aside in a safe place for reinstallation.

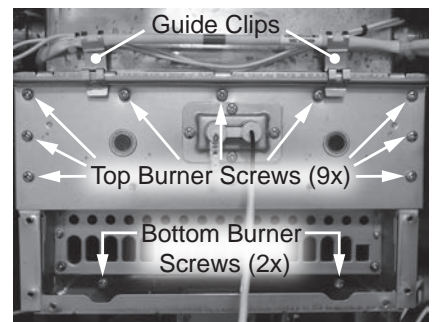

Figure 127 - Burner screws and guide clips

- 19 Remove burner assembly from water heater and dispose of properly.

SERVICE (COMBUSTION COMPONENTS)

Installing New Burner Assembly

- 20 Locate the new burner assembly provided in the kit. Install burner assembly to water heater with the nine top screws previously removed in **Step 18**.
- 21 Locate the two bottom screws previously removed in **Step 17** and secure bottom of burner assembly to water heater.
- 22 Install the OHCF guide clips to burner assembly previously removed in **Step 16**.

Installing Gas Manifold

- 23 Locate the gas manifold gasket provided in the kit. Use a plastic scraper to gently scrape old insulation gasket clean from gas manifold. Confirm assembly surface is free of any debris or leftover insulation. Install new gasket to gas manifold. See Figure 128.

IMPORTANT! DO NOT gouge or damage assembly surface when removing insulation gasket.

NOTICE: Handle with care and verify gasket is not dirty or damaged.



Figure 128 - Replacing gas manifold gasket

- 24 Locate the new gas valve O-ring provided in the kit. Install O-ring to gas valve as shown in Figure 129.

NOTICE: Handle with care and verify lubricant has been applied to O-ring and O-ring is not dirty or damaged.

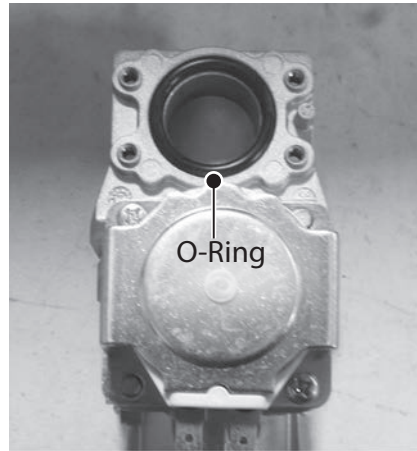

Figure 129 - O-ring replacement (one O-ring)

- 25 Install gas manifold to burner assembly using the eight screws previously removed in **Step 14**.

NOTICE: Inspect new burner assembly surface for debris and clean surface if necessary. Confirm new gas manifold gasket is free of debris before installing to burner assembly.

- 26 Locate the four screws previously removed in **Step 13** and secure the gas manifold to the gas valve. See Figure 125.
- 27 Locate the gas manifold wire harness and connect it. See Figure 124.

Installing the Ignitor Assembly

- 28 Locate the ignitor assembly. Connect the two spade terminal connections to the ignitor assembly. Confirm electrical connections are tight.

NOTICE: There is one large and one small spade terminal connection.

- 29 Mount the ignitor assembly to the gas manifold and secure with the two screws previously removed in **Step 10**.

- 30 Reconnect the ignitor wire previously removed in **Step 9**.

Installing UIM and Bracket

- 31 Secure the User Interface Module (UIM) and bracket to water heater with the four screws previously removed in **Step 7**. Confirm all electrical connections are snug and properly routed behind bracket.

Connecting Flame Sensor Wire

- 32 Locate the flame sensor previously disconnected from burner assembly in **Step 5**. Connect flame sensor wire. See Figure 119.

Checking for Gas Leaks

IMPORTANT! DO NOT apply liquids to any of the electrical connections when checking for gas leaks. Use a towel or rag to protect any electrical components.

- 33 Turn **ON** the gas supply to the water heater at the manual gas shut off valve. Restore power to the water heater. Open all hot water fixtures in the house. This will initiate the call for heat at the water heater.
- 34 Use code approved methods to check for leaks around all gas connection points. If any leaks are detected, resecure components and recheck for leaks.

- 35 Close all hot water fixtures in the house once the check is complete.

Returning Water Heater to Operation

- 36 Replace the cabinet cover and secure with the two screws previously removed in **Step 3**.
- 37 The water heater is now ready for operation.

SERVICE (COMBUSTION COMPONENTS)

Primary & Secondary Heat Exchangers (HEX), OHCF Wire

Kit 100390054 Contains:

- Primary HEX Assembly
- (4x) O-ring (15.5 x 2.5)
- Gas Manifold Gasket
- Burner Assembly Gasket
- Kit Instructions

Kit 100390052 Contains:

- Secondary HEX Assembly
- (4x) O-ring (15.5 x 2.5)
- HEX Gasket
- Kit Instructions

Kit 100390055 Contains:

- Overheat Cutoff Fuse (OHCF) Wire
- Kit Instructions

IMPORTANT: Use only factory authorized replacement parts. **DO NOT USE ELECTRIC SCREWDRIVERS OR DRILLS, HAND TIGHTEN ALL SCREWS TO PREVENT OVER TIGHTENING.** If you lack the necessary skills to properly perform the installation, you should not proceed, but get help from a qualified service technician.

Tools and Materials Required:

- 12" Magnetized Phillips Screwdriver
- Bucket or Pan
- Towel or Rag
- Safety Gloves

WARNING!

This kit shall be installed by a qualified service agency in accordance with the manufacturer's instructions and all applicable codes and requirements of the authority having jurisdiction. The information in these instructions must be followed to minimize the risk of fire or explosion or to prevent property damage, personal injury or death. The qualified service agency is responsible for the proper installation of this kit.

Preparing Water Heater for Service

- 1 Disconnect power to the water heater by unplugging it or by turning off the circuit at the breaker box, as appropriate. The power button on the water heater and remote **DOES NOT** disconnect power to the water heater. You must physically disconnect power to the water heater.
- 2 Shut **OFF** the gas supply to the water heater at the manual gas shut off valve.
- 3 Shut **OFF** the cold water supply to the water heater at the cold inlet valve.
- 4 Open all hot water fixtures in the house. When the residual water flow has ceased, close all hot water fixtures. This will depressurize the water heater.

Draining the Water Heater

- 5 Drain the X3®/Bypass Cartridge. Place a bucket or pan underneath cartridge to collect water during removal.
- 6 Locate the three (3) screws securing the X3®/Bypass cartridge as shown in Figure 130. Remove the (A) M4-12mm screw and the two (B) M4-25mm screws from cartridge. Place screws aside in a safe place for reinstallation.

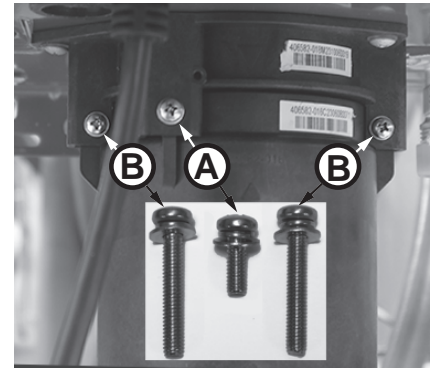

Figure 130 - Identify cartridge screws

- 7 Pull down to remove the cartridge from the water heater. Wait a few minutes to ensure all water has completely drained.
- 8 Locate and remove the inlet filter as shown in Figure 131 to drain any residual water left in the system. Place a bucket or pan underneath inlet filter to collect water during removal.

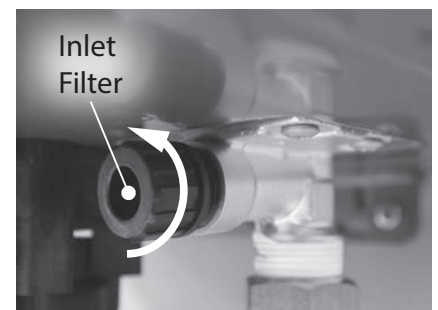

Figure 131 - Removing the inlet filter

SERVICE (COMBUSTION COMPONENTS)

9 Once the water heater has been adequately drained, reinstall inlet filter to water heater and tighten by hand. Confirm inlet filter is secured to water heater.

10 Reinstall the cartridge to the water heater. Locate the screws previously removed in **Step 6**. Insert and snug all three (3) screws by hand.

NOTICE: The X3® cartridge is keyed to only install in one direction. Align the ▲ on the cartridge with the ▼ on the manifold (the arrows will be facing the backside of the water heater). When inserting the cartridge, push up until the screw holes align. Some resistance is normal. The bypass cartridge is not keyed and will install in either direction.

11 Use a screwdriver to tighten the two (B) screws first and lastly tighten screw (A). **DO NOT** use a drill or impact driver to tighten the screws.

12 Locate the heat exchanger (HEX) drain line underneath the water heater. See Figure 132. Remove the two screws securing the metal bracket and place them aside in a safe place for reinstallation.

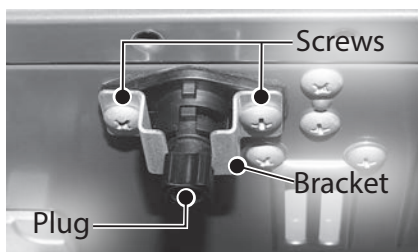

Figure 132 - HEX drain assembly

13 Remove the HEX drain plug by twisting and pulling down. Set the plug aside in a safe place for reinstallation.

14 Once the HEX drain line has been adequately drained, reinstall it. Confirm HEX drain plug is secured and reinstall the bracket using the two (2) screws removed in **Step 12**.

Accessing Water Heater Components

15 Locate the two (2) screws at the bottom of the cabinet cover. Use a Phillips screwdriver to remove the screws. Place screws aside in a safe place for reinstallation.

16 Lift cover up and away from cabinet to gain access to the water heater's internal components.

Disconnecting Flame Sensor Wire

17 Locate flame sensor wire attached to burner assembly. Disconnect wire and place aside for easy access to the gas manifold. See Figure 133.

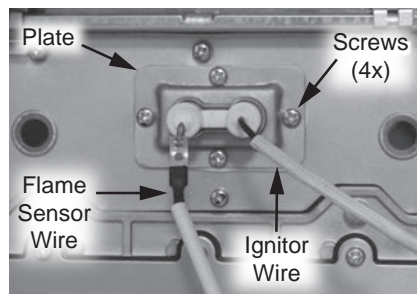

Figure 133 - Removing flame sensor wire

Disconnecting UIM and Bracket

18 Locate both green ground wires attached to gas manifold cover. Remove the two screws securing the green ground wires and place them aside in a safe place for reinstallation. See Figure 134.

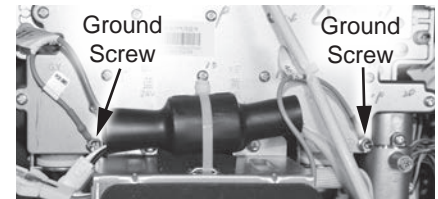

Figure 134 - Removing green ground wires

19 Locate the User Interface Module (UIM) and bracket. Remove the four screws securing bracket to the water heater. Place screws aside in a safe place for reinstallation. See Figure 135.

NOTICE: UIM, bracket and wiring do not need to be disconnected. Allow UIM and bracket to rest below water heater for easier access.

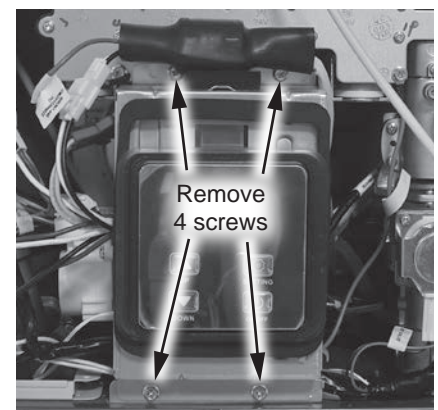

Figure 135 - Removing UIM and bracket screws

SERVICE (COMBUSTION COMPONENTS)

Removing the Ignitor Assembly

- 20 Locate the ignitor assembly on the right side of the water heater. See Figure 136.
- 21 Disconnect the ignitor wire from the ignitor assembly. See Figure 136.
- 22 Remove the two screws securing the ignitor assembly and bracket to the gas manifold. Place screws aside in a safe place for reinstallation. See Figure 136.

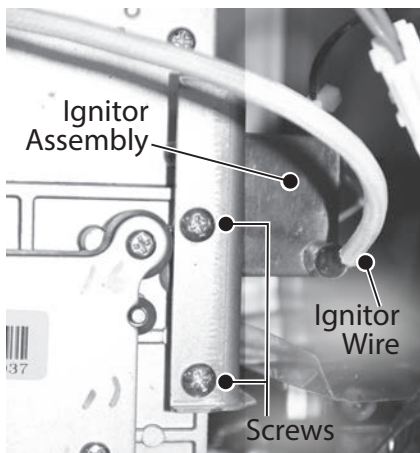

Figure 136 - Ignitor assembly location

- 23 Disconnect the two spade terminal connections at the back of ignitor and remove ignitor assembly and bracket from water heater. See Figure 137.

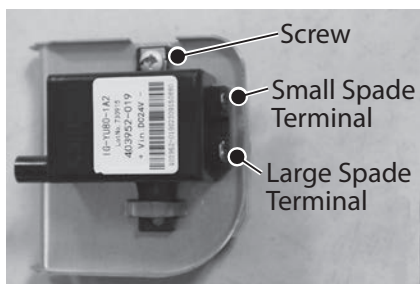

Figure 137 - Disconnecting ignitor assembly wires

Disconnecting Flow Control Valve

- 24 Locate the flow control valve in the water heater as shown in Figure 138.

NOTICE: Some components and wiring have been removed for clarity.

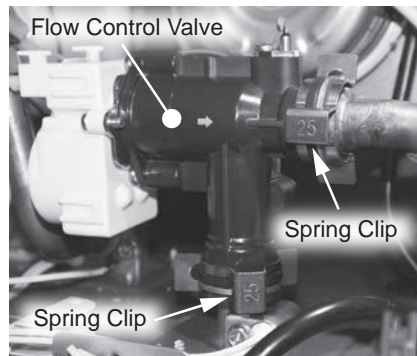

Figure 138 - Locating and disconnecting flow control valve

⚠ CAUTION! Water may still be present in the valve assembly. Place a rag under the valve connection points to prevent water from escaping into the water heater cabinet.

- 25 Remove the two spring clips (size 25) securing the flow control valve to the piping system. Place the spring clips aside in a safe place for reinstallation. See Figure 138.
- 26 Remove the flow control valve from the piping system and allow it to rest near the bottom of the water heater for easier access.

Disconnecting Gas Manifold Wire Harness

- 27 Locate the gas manifold wire harness and disconnect it. See Figure 139.

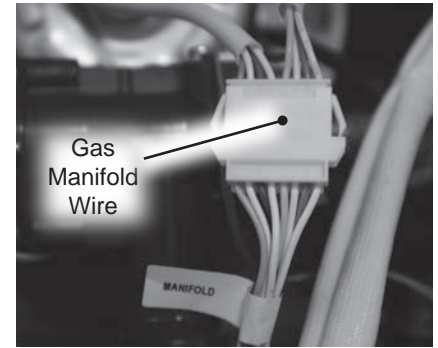

Figure 139 - Disconnecting gas manifold wire

Disconnecting Overheat Cutoff Fuse (OHCF) Wire

- 28 Locate the OHCF wire and disconnect it. See Figure 140.

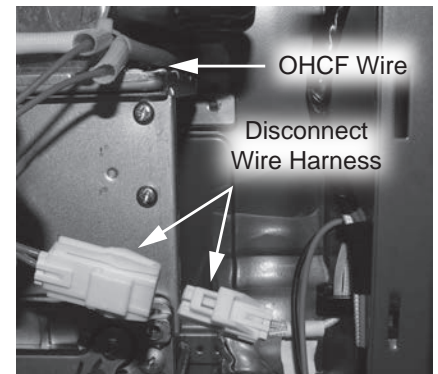

Figure 140 - Disconnecting OHCF wire

Removing Fan Assembly

- 29 Locate the five screws securing the fan assembly to the burner. There are two screws securing the front of the fan assembly (A), two screws securing the back of the fan assembly (B), and one screw securing the fan bracket (C) to the water heater cabinet. See Figure 141 & Figure 142.

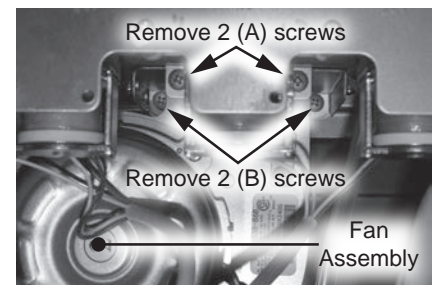

Figure 141 - Fan screw location (A & B)

SERVICE (COMBUSTION COMPONENTS)

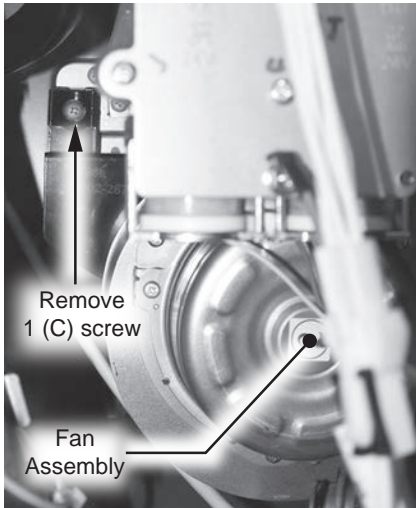

Figure 142 - Fan screw location (C)

- 30 Remove all screws and place them aside in a safe place for reinstallation.
- 31 Remove fan assembly from burner and allow it to rest near the bottom of the water heater cabinet for easier access.

Disconnecting Exhaust Thermistor

- 32 Locate and disconnect the exhaust thermistor wire harness at the secondary heat exchanger. See Figure 143.

NOTICE: To disconnect the exhaust thermistor, use a pair of needle nose pliers to gently press down on the connector tab while pulling connections apart.

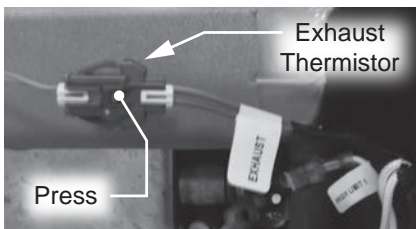

Figure 143 - Disconnecting exhaust thermistor

Removing Hi-Limit Switch

- 33 Locate the hi-limit switch on the primary heat exchanger (top right side of water heater). Disconnect the two wire leads from the hi-limit switch. See Figure 144.

Wire leads are labeled: HIGH LIMIT 1

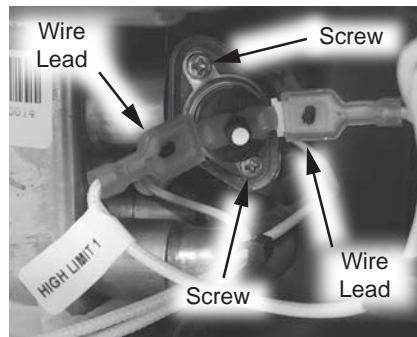

Figure 144 - Hi-Limit switch location

Steps 34 & 35 are only necessary if replacing the primary HEX. If replacing the secondary HEX, proceed to Step 36.

- 34 Use a Phillips screwdriver to remove the two screws securing the hi-limit switch to the heat exchanger. Place screws aside in a safe place for reinstallation. See Figure 144.
- 35 Remove hi-limit switch from primary heat exchanger and place aside in a safe place for reinstallation.

Disconnecting Primary HEX Water Piping

- 36 Locate the inlet and outlet water connections on the primary HEX. Remove the two spring clips (size 25) securing the water connections and place them aside in a safe place for reinstallation. Disconnect piping. See Figure 145.

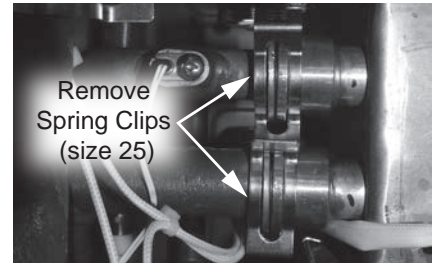

Figure 145 - Disconnecting primary HEX water piping

Disconnecting Secondary HEX Water Piping

- 37 Locate the inlet and outlet water connections on the secondary HEX. Remove the two spring clips (size 25) securing the water connections and place them aside in a safe place for reinstallation. Disconnect piping. See Figure 146.

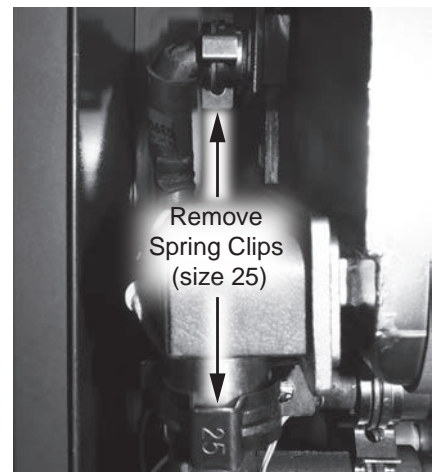

Figure 146 - Disconnecting secondary HEX water piping

Removing Primary HEX Heater Cylinders

- 38 Locate the two heater cylinders on the left and right side of the primary HEX. The heater cylinders are held in place by flexible brackets.

SERVICE (COMBUSTION COMPONENTS)

39 Use a Phillips screwdriver to gently pry the flexible brackets away from the HEX to allow space for the heater cylinders and wires to slide out. Remove the two heater cylinders. See Figure 147.

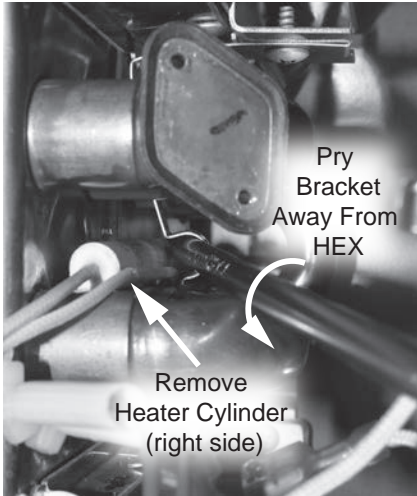

Figure 147 - Removing primary HEX heating cylinders

Removing Secondary HEX Heater Cylinder

40 Locate the heater cylinder on the left side of the secondary HEX. The heater cylinder is held in place by a flexible bracket. Remove the heater cylinder. See Figure 148.

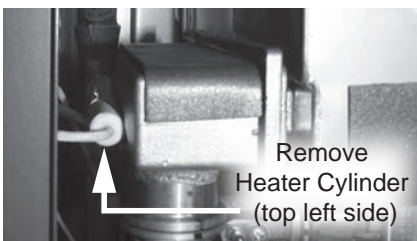

Figure 148 - Removing secondary HEX heating cylinders

Removing Condensate Hose

41 Disconnect the black condensate hose from the top of the condensate trap and the secondary HEX. Compress the spring clamp and pull it down along with the black hose. Place it aside in a safe place for reinstallation. See Figure 149.

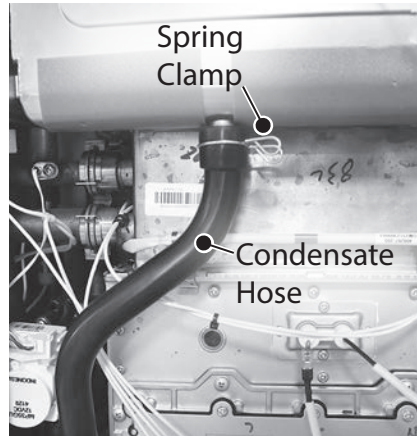

Figure 149 - Removing black condensate hose

Removing Gas Valve Screws

42 Locate and remove the four screws securing the gas valve to the gas manifold. Place screws aside in a safe place for reinstallation. See Figure 150.

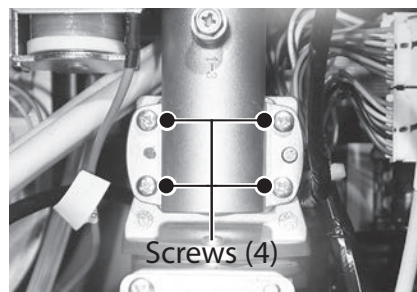

Figure 150 - Remove screws securing gas valve

Disconnecting Clear Gas Tube

43 Locate the clear gas tube connected to the gas valve and primary heat exchanger assembly. Disconnect the clear gas tube from the primary heat exchanger assembly. See Figure 151.

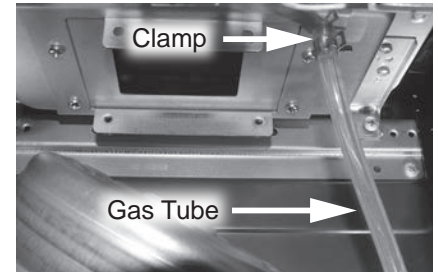

Figure 151 - Disconnecting clear gas tube

Removing HEX Assembly



Lifting Risk

▲ WARNING! The heat exchanger is heavy. Follow these precautions to reduce the risk of property damage, injuries from lifting or impact injuries from dropping the water heater.

44 Locate the bottom horizontal bracket and two (A) screws securing the primary heat exchanger assembly to the backside of the water heater cabinet as shown in Figure 152. Use a 12" magnetized Phillips screwdriver to remove the screws. Place them aside in a safe place for reinstallation.

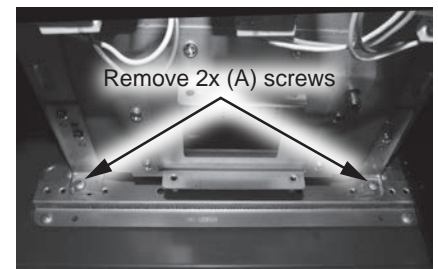

Figure 152 - Removing primary HEX (A) screws

SERVICE (COMBUSTION COMPONENTS)

45 Locate the upper horizontal bracket and two (B) screws securing the primary heat exchanger assembly to the backside of the water heater cabinet as shown in Figure 153. Use a 12" magnetized Phillips screwdriver to remove the screws. Place them aside in a safe place for reinstallation.

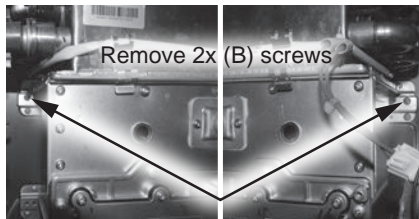

Figure 153 - Removing primary HEX (B) screws

46 Locate the two brackets and four (C) screws securing the secondary heat exchanger assembly to the backside of the water heater cabinet as shown in Figure 154. Use a 12" magnetized Phillips screwdriver to remove the screws. Place them aside in a safe place for reinstallation.

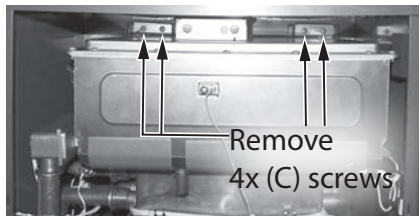

Figure 154 - Removing secondary HEX (C) screws

47 Locate the heat exchanger install bracket and two screws at the top of the water heater cabinet as shown in Figure 155.

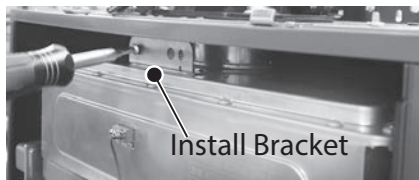

Figure 155 - HEX install bracket and screws

⚠ WARNING! Once top screws are removed from bracket the heat exchanger will come free. Properly support the weight of the heat exchanger when removing screws. Failure to properly support the weight of the heat exchanger could cause property damage or personal injury.

48 Remove the top two screws from install bracket. Allow heat exchanger to drop slightly so it can be disconnected from exhaust port then lift to remove heat exchanger from the two cabinet support brackets and the water heater. See Figure 156 and Figure 157 for reference.

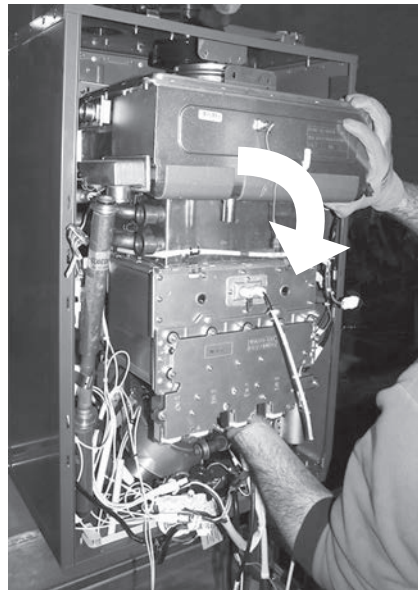

Figure 156 - Removing heat exchanger assembly

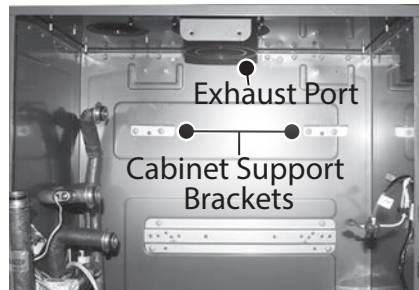

Figure 157 - Cabinet support brackets

49 Remove the two heater cylinder flexible brackets and screws secured to the HEX assembly. Place brackets and screws aside in a safe place for reinstallation.

50 Once brackets have been removed, locate the 24 screws securing the primary heat exchanger to the secondary heat exchanger. Remove screws and place aside in a safe place for reinstallation. See Figure 158.

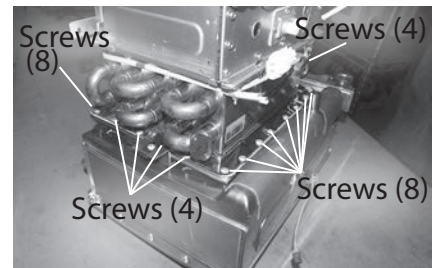

Figure 158 - Removing HEX assembly screws

51 Separate the primary and secondary heat exchangers.

Preparing New Primary Heat Exchanger for Installation (Kit 100390054 Only)

52 Locate the gas manifold on the old primary heat exchanger. Remove the eight screws securing the gas manifold and place them aside in a safe place for reinstallation. See Figure 159.

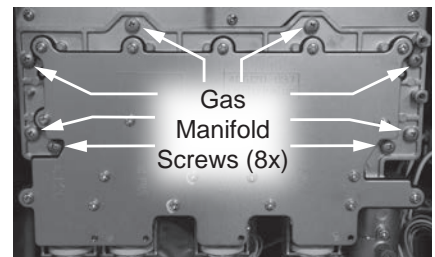

Figure 159 - Removing gas manifold from old primary heat exchanger

SERVICE (COMBUSTION COMPONENTS)

53 Remove gas manifold and place it aside in a safe place for reinstallation.

54 Locate the overheat cutoff fuse (OHCF) above the burner assembly. Remove the two guide clips from the burner assembly routing the OHCF around the primary heat exchanger. Dispose of guide clips and OHCF properly. See Figure 160.

55 Locate the (2x) bottom screws and (9x) top screws securing the burner assembly to the old primary heat exchanger as shown in Figure 160. Use a 12" magnetized Phillips screwdriver to remove screws. Place screws aside in a safe place for reinstallation.

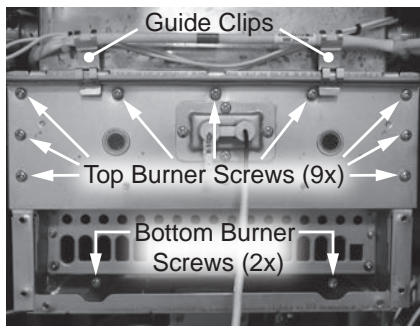

Figure 160 - Burner screws and guide clips

56 Remove burner assembly from old primary heat exchanger.

57 Use a plastic scraper to gently scrape old insulation gasket clean from primary heat exchanger and burner assembly. Confirm assembly surfaces are free of any debris or leftover insulation. Install burner assembly gasket to burner assembly. See Figure 161.

IMPORTANT! DO NOT gouge or damage assembly surfaces when removing insulation gasket.

NOTICE: Handle with care and verify gasket is not dirty or damaged.

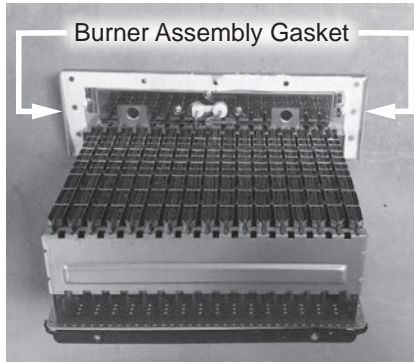

Figure 161 - Replacing burner assembly gasket

58 Locate the new primary heat exchanger provided in the kit. Remove the two guide clips securing the new OHCF. Install burner assembly to new primary heat exchanger. Secure burner assembly with the (2x) bottom screws and the (9x) top screws previously removed in **Step 55**.

59 Resecure the new OHCF wire to new primary HEX and burner assembly using the guide clips removed in **Step 58**. Confirm wire fits snug into the four guide clips installed to the front and backside of new primary HEX.

60 Locate the gas manifold gasket provided in the kit. Use a plastic scraper to gently scrape old insulation gasket clean from gas manifold. Confirm assembly surface is free of any debris or leftover insulation. Install new gasket to gas manifold. See Figure 162.

IMPORTANT! DO NOT gouge or damage assembly surface when removing insulation gasket.

NOTICE: Handle with care and verify gasket is not dirty or damaged.

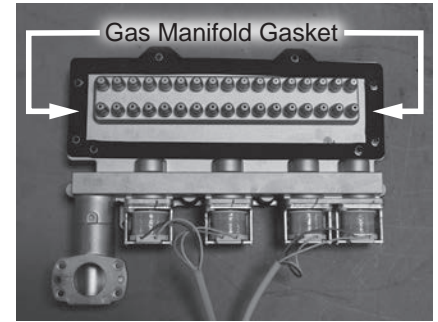

Figure 162 - Replacing gas manifold gasket

61 Install gas manifold to new primary heat exchanger. Secure gas manifold with the eight screws previously removed in **Step 52**.

62 Locate the four new O-rings provided in the kit. Remove the old O-rings from inlet and outlet water connections for the HEX assembly and replace with new O-rings. See Figure 163.

NOTICE: Handle with care and verify lubricant has been applied to O-rings. Confirm O-rings are not dirty or damaged.

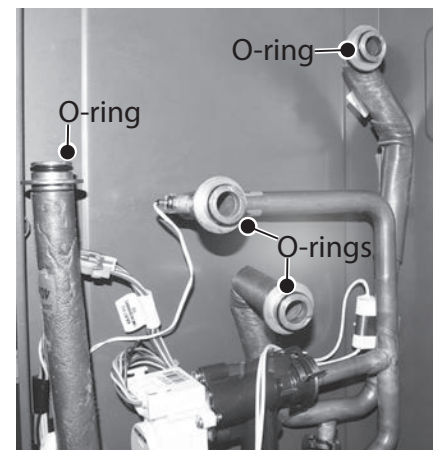

Figure 163 - Replacing HEX O-rings

63 Dispose of old primary heat exchanger properly.

The new primary heat exchanger is now ready for installation. Proceed to the **Installing Heat Exchanger** section on the following page.

SERVICE (COMBUSTION COMPONENTS)

Preparing New Secondary Heat Exchanger for Installation (Kit 100390052 Only)

64 Locate the HEX gasket provided in the kit. Use a plastic scraper to gently scrape old insulation gasket clean from the primary and secondary heat exchangers. Confirm assembly surfaces are free of any debris or leftover insulation. Install new gasket to primary heat exchanger. See Figure 164.

IMPORTANT! DO NOT gouge or damage assembly surface when removing insulation gasket.

NOTICE: Handle with care and verify gasket is not dirty or damaged.

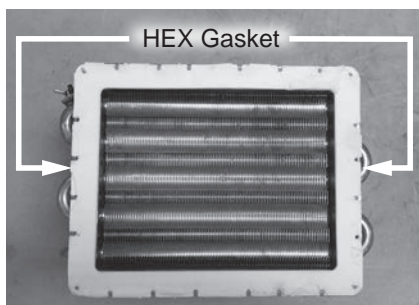

Figure 164 - Replacing HEX gasket

65 Locate the four new O-rings provided in the kit. Remove the old O-rings from inlet and outlet water connections for the HEX assembly and replace with new O-rings. See Figure 163.

NOTICE: Handle with care and verify lubricant has been applied to O-rings. Confirm O-rings are not dirty or damaged.

66 Dispose of old secondary heat exchanger properly.

The new secondary heat exchanger is now ready for installation. Proceed to the **Installing Heat Exchanger** section.

Replacing OHCF Wire (Kit 100390055 Only)

67 Remove the old OHCF wire from the primary HEX. Dispose of wire properly.

68 Locate the new OHCF wire provided in the kit and install to primary HEX. Confirm wire fits snug into the four guide clips on the front and backside of primary HEX.

Proceed to the **Installing Heat Exchanger** section.

Installing Heat Exchanger



Lifting Risk

▲ WARNING! The heat exchanger is heavy. Follow these

precautions to reduce the risk of property damage, injuries from lifting or impact injuries from dropping the water heater.

69 Secure primary HEX to secondary HEX with the 24 screws previously removed in **Step 50**. See Figure 158 as reference.

70 Secure the two heater cylinder flexible brackets and screws to HEX assembly previously removed in **Step 49**.

71 Locate the top two install bracket screws previously removed in **Step 48**. Place both screws and a Phillips screwdriver on top of water heater cabinet for ease of access when installing heat exchanger assembly.

72 Lift heat exchanger assembly into water heater cabinet. Lean the top side of heat exchanger slightly toward you so the two tabs on the backside of the secondary heat exchanger insert into the two cabinet support brackets as shown in Figure 157.

Once the tabs are inserted, push heat exchanger upright into exhaust port so screw holes in the install bracket align properly with the top bracket on the secondary heat exchanger as shown in Figure 165.

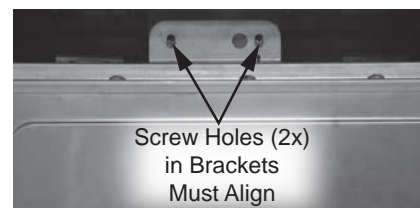

Figure 165 - Align screw holes in brackets

SERVICE (COMBUSTION COMPONENTS)

73 Hold heat exchanger in place and secure with the top two screws placed on the water heater cabinet in **Step 71**.

NOTICE: Verify all 8 screw hole locations on the primary and secondary heat exchangers properly align with screw holes in the water heater cabinet and horizontal brackets. To realign heat exchanger screw holes, lift heat exchanger from underneath and shift upward to center the assembly.

74 Locate the four secondary heat exchanger mounting screws previously removed in **Step 46**. Use a 12" magnetized Phillips screwdriver and four screws to secure the heat exchanger to the water heater cabinet. See Figure 154.

75 Locate the four primary heat exchanger mounting screws previously removed in **Steps 44 & 45**. Use a 12" magnetized Phillips screwdriver and four screws to secure the heat exchanger to the two horizontal brackets. See Figure 152 & Figure 153.

IMPORTANT! The heat exchanger is now secured to the water heater and fully supported.

Connecting Clear Gas Tube

76 Locate the clear gas tube previously disconnected in **Step 43**. Connect the clear gas tube to the primary heat exchanger. See Figure 151.

Securing Gas Valve

77 Locate the four gas valve screws previously removed in **Step 42**. Secure gas valve to the gas manifold and heat exchanger assembly. See Figure 150.

Installing Black Condensate Hose

78 Locate the black condensate hose previously removed in **Step 41**. Connect the hose to the secondary HEX. Make sure the hose is fully seated along with the spring clamp. Reattach the other end of the hose to the top of the condensate trap. Check the connections to ensure they are fully seated to prevent leaks. See Figure 149.

Installing HEX Heating Cylinders

79 Locate the heating cylinders previously removed from the primary and secondary heat exchangers in **Steps 39 & 40**. Slide heat cylinders into brackets so cylinders sit flush against heat exchangers. See Figure 147 and Figure 148 as reference.

Connecting HEX Water Piping

80 Connect the inlet and outlet water piping to the primary and secondary heat exchangers previously disconnected in **Steps 36 & 37**. Secure piping connections with the four spring clips (size 25). Confirm connections are tight and will not leak. See Figure 145 and Figure 146 for reference.

Installing Hi-Limit Switch

81 If the primary HEX assembly was removed, locate the hi-limit switch and two screws previously removed in **Steps 34 & 35**. Install hi-limit switch to primary heat exchanger and secure with the two screws.

82 Reconnect the wire leads to hi-limit switch previously disconnected in **Step 33**. See Figure 144 as reference.

Connecting Exhaust Thermistor

83 Connect the exhaust thermistor wire harness to the secondary heat exchanger previously disconnected in **Step 32**. See Figure 143.

Installing Fan Assembly

84 Locate the fan assembly and five screws previously removed in **Steps 29-31**. Install fan assembly outlet firmly into burner. Verify all screw hole locations align properly. Secure fan assembly with the five screws, starting with the bracket screw (C) to help stabilize the fan assembly. See Figure 141 & Figure 142.

Connecting Overheat Cutoff Fuse (OHCF) Wire

85 Locate the OHCF wire previously disconnected in **Step 28**. Connect the wire. See Figure 140.

SERVICE (COMBUSTION COMPONENTS)

Connecting Gas Manifold Wire Harness

86 Locate the gas manifold wire harness previously disconnected in **Step 27** and connect it. See Figure 139.

Installing Flow Control Valve

87 Locate the flow control valve and two spring clips (size 25) previously removed in **Steps 24-26**. Carefully install flow control valve to pipe connections. Install spring clips to flow control valve, securing it to piping connections. Verify water connections are tight and will not leak. See Figure 138.

Installing the Ignitor Assembly

88 Locate the ignitor assembly and two screws previously removed in **Steps 20-23**. Connect the two spade terminal connections to the ignitor assembly. Confirm electrical connections are tight.

NOTICE: There is one large and one small spade terminal connection.

89 Mount the ignitor assembly to the gas manifold and secure with the two screws.

90 Reconnect the ignitor wire previously removed in **Step 21**.

Installing UIM and Bracket

91 Secure the User Interface Module (UIM) and bracket to water heater with the four screws previously removed in **Step 19**. Confirm all electrical connections are snug and properly routed behind bracket. See Figure 135.

92 Connect the two green ground wires previously disconnected in **Step 18**. See Figure 134.

Connecting Flame Sensor Wire

93 Verify flame sensor wire is connected to the primary heat exchanger and PCB. This wire was previously disconnected in **Step 17**. See Figure 133.

Checking for Water Leaks

94 Turn **ON** the cold water supply to the water heater at the cold inlet valve. The system will fully pressurize and any leaks at water connections will be apparent. Correct any leaks immediately and dry water heater cabinet with a rag.

Checking for Gas Leaks

IMPORTANT! DO NOT apply liquids to any of the electrical connections when checking for gas leaks. Use a towel or rag to protect any electrical components.

95 Turn **ON** the gas supply to the water heater at the manual gas shut off valve.

96 Restore power to the water heater.

97 Open all hot water fixtures in the house. This will initiate the call for heat at the water heater.

98 Use code approved methods to check for leaks around all gas connection points and the heat exchanger. To protect electrical connections, **DO NOT** perform a bubble test. If any leaks are detected, resecure components and recheck for leaks.

99 Proceed to the next section once there are no leaks detected.

Returning Water Heater to Operation

100 Replace the cabinet cover and secure with the screws previously removed in **Step 15**.

The water heater is now ready for operation.

SERVICE (WETTED COMPONENTS)

Water Inlet Assembly

Kit 100389977 Contains:

- Inlet Assembly
- O-ring (15.5 x 2.5)
- Kit Instructions

IMPORTANT: Use only factory authorized replacement parts. **DO NOT USE ELECTRIC SCREWDRIVERS OR DRILLS, HAND TIGHTEN ALL SCREWS TO PREVENT OVER TIGHTENING.** If you lack the necessary skills to properly perform the installation, you should not proceed, but get help from a qualified service technician.

Tools and Materials Required:

- Phillips Screwdriver
- Thread Sealant/Pipe Dope
- Towel or Rag
- Bucket or Pan
- Safety Gloves

Preparing Water Heater for Service

- 1 Disconnect power to the water heater by unplugging it or by turning off the circuit at the breaker box, as appropriate. The power button on the water heater and remote **DOES NOT** disconnect power to the water heater. You must physically disconnect power to the water heater.
- 2 Shut **OFF** the gas supply to the water heater at the manual gas shut off valve.
- 3 Shut **OFF** the cold water supply to the water heater at the cold inlet valve.
- 4 Open all hot water fixtures in the house. When the residual water flow has ceased, close all hot water fixtures. This will depressurize the water heater.

Draining the Water Heater

- 5 Drain the X3®/Bypass Cartridge. Place a bucket or pan underneath cartridge to collect water during removal.
- 6 Locate the three (3) screws securing the X3®/Bypass cartridge as shown in Figure 166. Remove the (A) M4-12mm screw and the two (B) M4-25mm screws from cartridge. Place screws aside in a safe place for reinstallation.

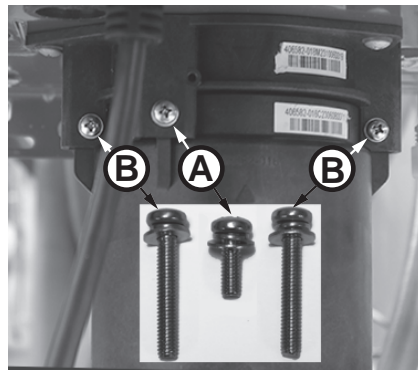

Figure 166 - Identify cartridge screws

- 7 Pull down to remove the cartridge from the water heater. Wait a few minutes to ensure all water has completely drained.
- 8 Locate and remove the inlet filter as shown in Figure 167 to drain any residual water left in the system.

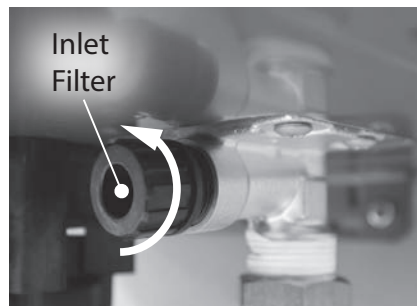

Figure 167 - Locate and remove inlet filter

- 9 Once the water heater has been adequately drained, reinstall inlet filter to water heater and tighten by hand. Confirm inlet filter is secured to water heater.
- 10 Reinstall the cartridge to the water heater. Insert the cartridge into manifold and secure with the two (2) long screws and one (1) short screw previously set aside in Step 6.

NOTICE: The X3® cartridge is keyed to only install in one direction. Align the ▲ on the cartridge with the ▼ on the manifold (the arrows will be facing the backside of the water heater). When inserting the cartridge, push up until the screw holes align. Some resistance is normal. The bypass cartridge is not keyed and will install in either direction.

- 11 Insert and snug all three (3) screws by hand. Use a screwdriver to tighten the two (B) screws first and lastly tighten screw (A). **DO NOT** use a drill or impact driver to tighten the screws.
- 12 Disconnect the cold water line to the cold inlet assembly.

Accessing Water Heater Components

- 13 Locate the two (2) screws at the bottom of the cabinet cover. Use a Phillips screwdriver to remove the screws. Place screws aside in a safe place for reinstallation.
- 14 Lift cover up and away from cabinet to gain access to the water heater's internal components

Disconnecting UIM and Bracket

- 15 Locate the User Interface Module (UIM) and bracket. Remove the four screws securing bracket to the water heater. Place screws aside in a safe place for reinstallation. See Figure 168.

SERVICE (WETTED COMPONENTS)

NOTICE: UIM, bracket and wiring do not need to be disconnected. Allow UIM and bracket to rest below water heater for easy access to inlet assembly.

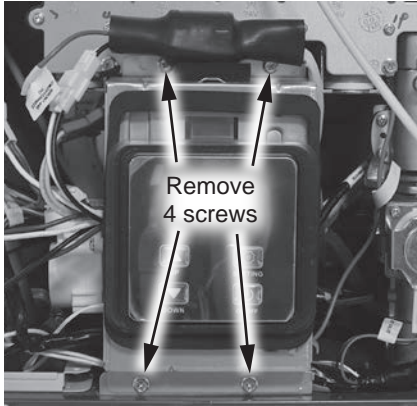

Figure 168 - Removing UIM and bracket screws

Removing the Inlet Assembly

16 Locate the spring clip (size 25) securing inlet assembly to flow control valve. Remove spring clip and place aside in a safe place for reinstallation. See Figure 169.

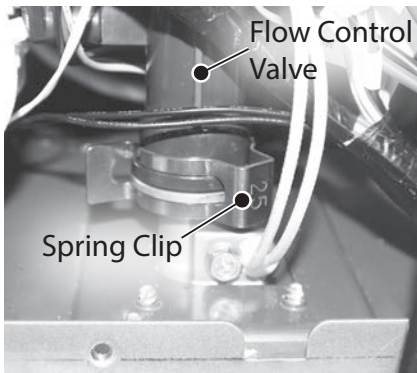

Figure 169 - Inlet assembly location

⚠ CAUTION! Water may still be present in the valve assembly. Place a rag under the valve connection points to prevent water from escaping into the water heater cabinet.

17 Locate the screw securing the heater block in the base of the inlet assembly. See Figure 170. Use a Phillips screwdriver to remove the screw. Place the screw aside in a safe place for reinstallation.

18 Remove the heater block from the base and set aside for reinstallation.

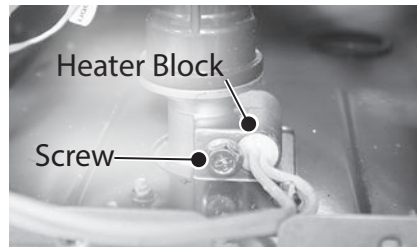

Figure 170 - Heater block location

19 Locate the inlet assembly at the bottom right side of the water heater as shown in Figure 171.

20 Locate the three (3) screws securing the inlet assembly to the base of the water heater. Use a Phillips screwdriver to remove the screws. Place screws aside in a safe place for reinstallation. See Figure 171.

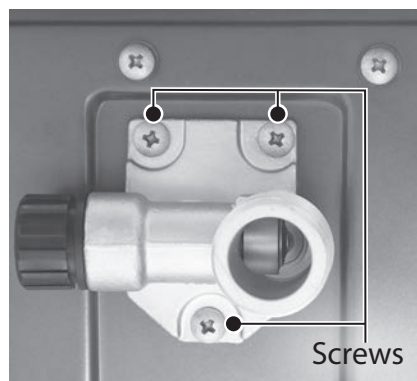

Figure 171 - Inlet assembly location

21 Remove the old inlet assembly from the piping system and dispose of properly.

Installing New Inlet Assembly

22 Locate the new inlet assembly and O-ring provided in the kit.

23 Place the new O-ring on the new inlet assembly.

NOTICE: Handle with care and verify lubricant has been applied to O-rings and O-rings are not dirty or damaged.

24 Place the new inlet assembly in the water heater and secure with the screws removed in **Step 20**.

25 Reinstall the heater block to the base of the inlet assembly and secure with the screw removed in **Step 17**.

26 Locate the spring clip (size 25) previously removed in **Step 16**. Secure inlet assembly to flow control valve with spring clip.

27 Reconnect the cold water line disconnected in **Step 12**. Use thread sealant tape or pipe dope when making the connection.

Installing UIM and Bracket

28 Secure the User Interface Module (UIM) and bracket to water heater with the four screws previously removed in **Step 15**. Confirm all electrical connections are snug and properly routed behind bracket.

Checking for Water Leaks

29 Turn **ON** the cold water supply to the water heater at the cold inlet valve. The system will fully pressurize and any leaks at water connections will be apparent. Correct any leaks immediately and dry water heater cabinet with a rag.

Returning Water Heater to Operation

30 Replace the cabinet cover and secure with the screws previously removed in **Step 13**.

31 Turn **ON** the gas supply to the water heater at the manual gas shut off valve.

32 Restore power to the water heater. The water heater is now ready for operation.

SERVICE (WETTED COMPONENTS)

Flow Control Valve

Kit 100389978 Contains:

- Flow Control Valve
- (2x) O-ring (15.5 x 2.5)
- Kit Instructions

IMPORTANT: Use only factory authorized replacement parts. **DO NOT USE ELECTRIC SCREWDRIVERS OR DRILLS, HAND TIGHTEN ALL SCREWS TO PREVENT OVER TIGHTENING.** If you lack the necessary skills to properly perform the installation, you should not proceed, but get help from a qualified service technician.

Tools and Materials Required:

- Phillips Screwdriver
- Bucket or Pan
- Towel or Rag
- Safety Gloves

Preparing Water Heater for Service

- 1 Disconnect power to the water heater by unplugging it or by turning off the circuit at the breaker box, as appropriate. The power button on the water heater and remote **DOES NOT** disconnect power to the water heater. You must physically disconnect power to the water heater.
- 2 Shut **OFF** the gas supply to the water heater at the manual gas shut off valve.
- 3 Shut **OFF** the cold water supply to the water heater at the cold inlet valve.
- 4 Open all hot water fixtures in the house. When the residual water flow has ceased, close all hot water fixtures. This will depressurize the water heater.

Draining the Water Heater

- 5 Drain the X3®/Bypass Cartridge. Place a bucket or pan underneath cartridge to collect water during removal.
- 6 Locate the three (3) screws securing the X3®/Bypass cartridge as shown in Figure 172. Remove the (A) M4-12mm screw and the two (B) M4-25mm screws from cartridge. Place screws aside in a safe place for reinstallation.

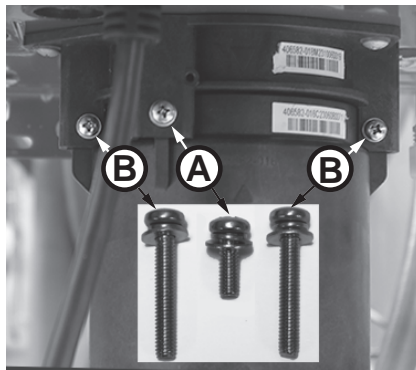

Figure 172 - Identify cartridge screws

- 7 Pull down to remove the cartridge from the water heater. Wait a few minutes to ensure all water has completely drained.
- 8 Locate and remove the inlet filter as shown in Figure 173 to drain any residual water left in the system. Place a bucket or pan underneath inlet filter to collect water during removal.

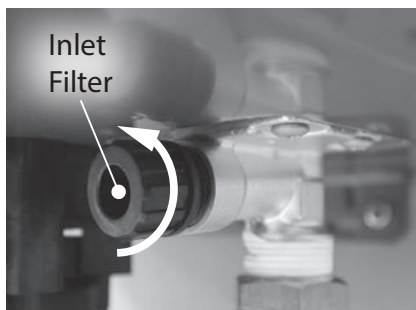

Figure 173 - Removing the inlet filter

- 9 Once the water heater has been adequately drained, reinstall inlet filter to water heater and tighten by hand. Confirm inlet filter is secured to water heater.
 - 10 Reinstall the cartridge to the water heater. Locate the screws previously removed in **Step 6**. Insert and snug all three (3) screws by hand.
- NOTICE:** The X3® cartridge is keyed to only install in one direction. Align the ▲ on the cartridge with the ▼ on the manifold (the arrows will be facing the backside of the water heater). When inserting the cartridge, push up until the screw holes align. Some resistance is normal. The bypass cartridge is not keyed and will install in either direction.
- 11 Use a screwdriver to tighten the two (B) screws first and lastly tighten screw (A). **DO NOT** use a drill or impact driver to tighten the screws.

Accessing Water Heater Components

- 12 Locate the two (2) screws at the bottom of the cabinet cover. Use a Phillips screwdriver to remove the screws. Place screws aside in a safe place for reinstallation.
- 13 Lift cover up and away from cabinet to gain access to the water heater's internal components.

SERVICE (WETTED COMPONENTS)

Removing Flow Control Valve

14 Locate the flow control valve behind the user interface module (UIM) bracket in the water heater as shown in Figure 174. Disconnect the three (3) wiring harnesses to the valve marked:

- "Main Water Valve"
- "Inlet" (Blue)
- "Flow" (White)

To disconnect the "Inlet" and "Flow" connections, use a pair of needle nose pliers to gently press down on the connector tab while pulling connections apart. See Figure 175.

NOTICE: Some components and wiring have been removed for clarity.

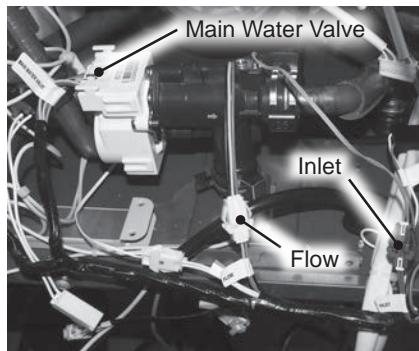

Figure 174 - Locating wiring harnesses

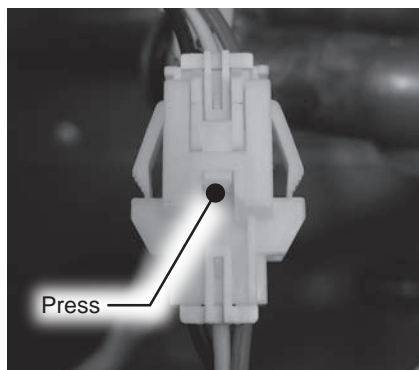

Figure 175 - Disconnecting inlet and flow

15 Remove the two (2) spring clips (size 25) securing the flow control valve to the piping system. Place the spring clips aside in a safe place for reinstallation. See Figure 176.

CAUTION! Water may still be present in the valve assembly. Place a rag under the valve connection points to prevent water from escaping into the water heater cabinet.

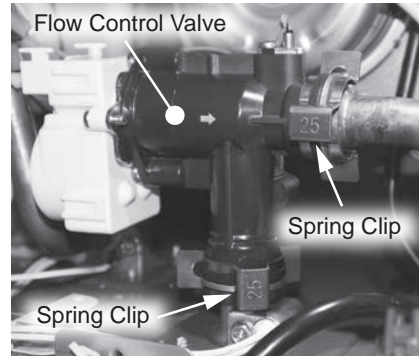

Figure 176 - Removing spring clips from flow control valve

16 Remove the flow control valve from the piping system and dispose of properly.

Installing New Flow Control Valve

17 Locate the two O-rings on the exposed water pipe connections as shown in Figure 177 and remove them. Dispose of O-rings properly.

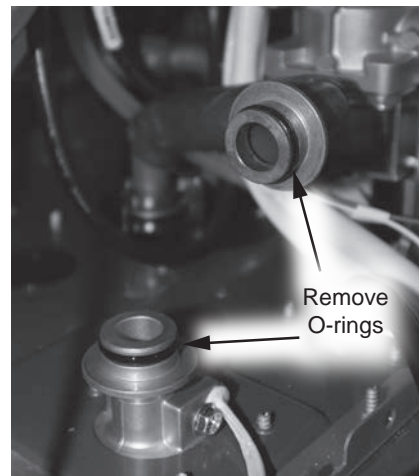

Figure 177 - Locating and removing O-rings

18 Locate the two (2) O-rings provided in the kit.

19 Install new O-rings to exposed water pipe connections.

NOTICE: Handle with care and verify lubricant has been applied to O-rings and O-rings are not dirty or damaged.

20 Locate the new flow control valve provided in the kit. Carefully install flow control valve to pipe connections.

21 Locate the two (2) spring clips previously removed in **Step 15**. Install spring clips to flow control valve, securing it to piping connections. See Figure 176. Verify water connections are tight and will not leak.

22 Reconnect the three (3) wiring harnesses to the flow control valve previously disconnected in **Step 14**. Confirm wiring connections are secure. See Figure 174.

Checking for Water Leaks

23 Turn **ON** the cold water supply to the water heater at the cold inlet valve. The system will fully pressurize and any leaks at water connections will be apparent. Correct any leaks immediately and dry water heater cabinet with a rag.

Returning Water Heater to Operation

24 Replace the cabinet cover and secure with the screws previously removed in **Step 12**.

25 Turn **ON** the gas supply to the water heater at the manual gas shut off valve.

26 Restore power to the water heater. The water heater is now ready for operation.

SERVICE (WETTED COMPONENTS)

Cartridge Manifold

Kit 100374732 Contains:

- Cartridge Manifold
- Kit Instructions

IMPORTANT: Use only factory authorized replacement parts. **DO NOT USE ELECTRIC SCREWDRIVERS OR DRILLS, HAND TIGHTEN ALL SCREWS TO PREVENT OVER TIGHTENING.** If you lack the necessary skills to properly perform the installation, you should not proceed, but get help from a qualified service technician.

Tools and Materials Required:

- Phillips Screwdriver
- Bucket or Pan
- Towel or Rag
- Safety Gloves

Preparing Water Heater for Service

- 1 Disconnect power to the water heater by unplugging it or by turning off the circuit at the breaker box, as appropriate. The power button on the water heater and remote **DOES NOT** disconnect power to the water heater. You must physically disconnect power to the water heater.
- 2 Shut **OFF** the cold water supply to the water heater at the cold inlet valve.
- 3 Open all hot water fixtures in the house. When the residual water flow has ceased, close all hot water fixtures. This will depressurize the water heater.

Draining the Water Heater

- 4 Drain the X3®/Bypass Cartridge. Place a bucket or pan underneath cartridge to collect water during removal.
- 5 Locate the three (3) screws securing the X3®/Bypass cartridge as shown in Figure 178. Remove the (A) M4-12mm screw and the two (B) M4-25mm screws from cartridge. Place screws aside in a safe place for reinstallation.

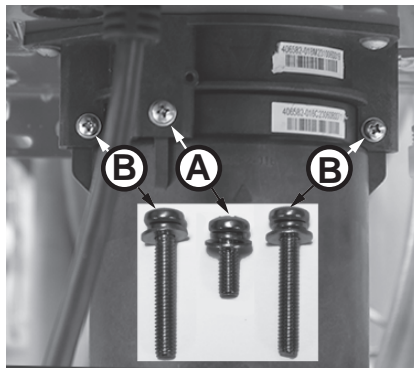

Figure 178 - Identify cartridge screws

- 6 Pull down to remove the cartridge from the water heater. Wait a few minutes to ensure all water has completely drained.
- 7 Locate and remove the inlet filter as shown in Figure 179 to drain any residual water left in the system. Place a bucket or pan underneath inlet filter to collect water during removal.

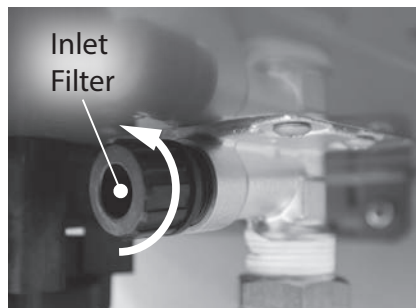

Figure 179 - Removing the inlet filter

- 8 Once the water heater has been adequately drained, reinstall inlet filter to water heater and tighten by hand. Confirm inlet filter is secured to water heater.

Accessing Water Heater Components

- 9 Locate the two (2) screws at the bottom of the cabinet cover. Use a Phillips screwdriver to remove the screws. Place screws aside in a safe place for reinstallation.
- 10 Lift cover up and away from cabinet to gain access to the water heater's internal components.

Disconnecting UIM and Bracket

- 11 Locate the User Interface Module (UIM) and bracket. Remove the four screws securing bracket to the water heater. Place screws aside in a safe place for reinstallation. See Figure 180.

NOTICE: UIM, bracket and wiring do not need to be disconnected. Allow UIM and bracket to rest below water heater for easy access to cartridge manifold.

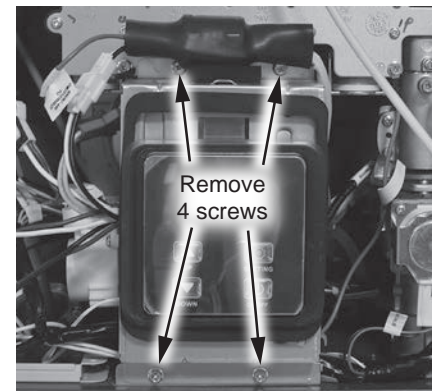

Figure 180 - Removing UIM and bracket screws

SERVICE (WETTED COMPONENTS)

Preparing Cartridge Manifold for Removal

12 Locate and remove the two spring clips (size 25) securing the manifold inlet tube and outlet tube to cartridge manifold. Place the spring clips aside in a safe place for reinstallation. See Figure 181.

▲ CAUTION! Water may still be present in the valve assembly. Place a rag under the valve connection points to prevent water from escaping into the water heater cabinet.

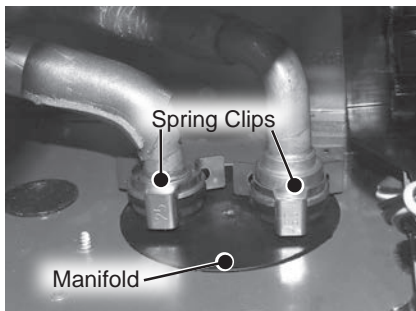

Figure 181 - Remove two spring clips from the cartridge manifold.

Removing Cartridge Manifold

13 Locate the three (3) screws securing the cartridge manifold to the underside of the water heater cabinet as shown in Figure 182. Use a Phillips screwdriver to remove screws. Place screws aside in a safe place for reinstallation.

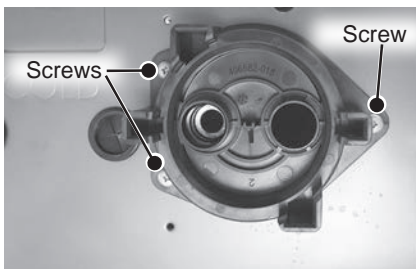

Figure 182 - Remove manifold screws

14 Remove the old cartridge manifold from the piping system and dispose of properly.

Installing Cartridge Manifold

- 15** Locate the new cartridge manifold provided in the kit.
- 16** Locate the three (3) screws previously removed in **Step 13**. Use screws to secure cartridge manifold to water heater cabinet. See Figure 182.
- 17** With cartridge manifold secured, reconnect the manifold inlet tube and outlet tube. Secure with the two spring clips (size 25) previously removed in **Step 12**.

Checking for Water Leaks

18 Reinstall the cartridge to the water heater. Locate the screws previously removed in **Step 5**. Insert and snug all three (3) screws by hand.

NOTICE: The X3® cartridge is keyed to only install in one direction. Align the ▲ on the cartridge with the ▼ on the manifold (the arrows will be facing the backside of the water heater). When inserting the cartridge, push up until the screw holes align. Some resistance is normal. The bypass cartridge is not keyed and will install in either direction.

- 19** Use a screwdriver to tighten the two **(B)** screws first and lastly tighten screw **(A)**. **DO NOT** use a drill or impact driver to tighten the screws.
- 20** Turn **ON** the cold water supply to the water heater at the cold inlet valve. The system will fully pressurize and any leaks at water connections will be apparent. Correct any leaks immediately and dry water heater cabinet with a rag.

Installing UIM and Bracket

21 Secure the User Interface Module (UIM) and bracket to water heater with the four screws previously removed in **Step 11**. Confirm all electrical connections are snug and properly routed behind bracket.

Returning Water Heater to Operation

- 22** Replace the cabinet cover and secure with the screws previously removed in **Step 9**.
- 23** Restore power to the water heater. The water heater is now ready for operation.

SERVICE (WETTED COMPONENTS)

Bypass Valve

Kit 100371165 Contains:

- Bypass Valve
- (2x) O-ring (15.5 x 2.5)
- Kit Instructions

IMPORTANT: Use only factory authorized replacement parts. **DO NOT USE ELECTRIC SCREWDRIVERS OR DRILLS, HAND TIGHTEN ALL SCREWS TO PREVENT OVER TIGHTENING.** If you lack the necessary skills to properly perform the installation, you should not proceed, but get help from a qualified service technician.

Tools and Materials Required:

- Phillips Screwdriver
- Bucket or Pan
- Towel or Rag
- Safety Gloves

Preparing Water Heater for Service

- 1 Disconnect power to the water heater by unplugging it or by turning off the circuit at the breaker box, as appropriate. The power button on the water heater and remote **DOES NOT** disconnect power to the water heater. You must physically disconnect power to the water heater.
- 2 Shut **OFF** the gas supply to the water heater at the manual gas shut off valve.
- 3 Shut **OFF** the cold water supply to the water heater at the cold inlet valve.
- 4 Open all hot water fixtures in the house. When the residual water flow has ceased, close all hot water fixtures. This will depressurize the water heater.

Draining the Water Heater

- 5 Drain the X3®/Bypass Cartridge. Place a bucket or pan underneath cartridge to collect water during removal.
- 6 Locate the three (3) screws securing the X3®/Bypass cartridge as shown in Figure 183. Remove the (A) M4-12mm screw and the two (B) M4-25mm screws from cartridge. Place screws aside in a safe place for reinstallation.

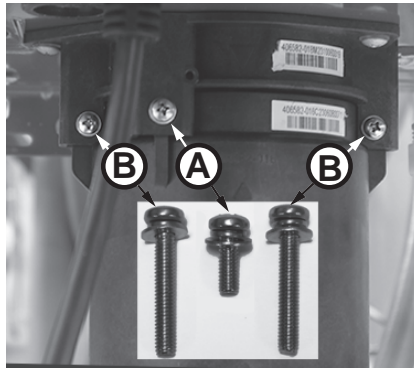

Figure 183 - Identify cartridge screws

- 7 Pull down to remove the cartridge from the water heater. Wait a few minutes to ensure all water has completely drained.
- 8 Locate and remove the inlet filter as shown in Figure 184 to drain any residual water left in the system. Place a bucket or pan underneath inlet filter to collect water during removal.

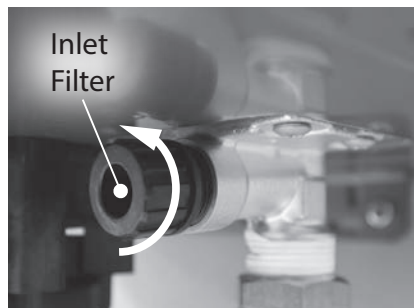

Figure 184 - Removing the inlet filter

- 9 Once the water heater has been adequately drained, reinstall inlet filter to water heater and tighten by hand. Confirm inlet filter is secured to water heater.
 - 10 Reinstall the cartridge to the water heater. Locate the screws previously removed in **Step 6**. Insert and snug all three (3) screws by hand.
- NOTICE:** The X3® cartridge is keyed to only install in one direction. Align the ▲ on the cartridge with the ▼ on the manifold (the arrows will be facing the backside of the water heater). When inserting the cartridge, push up until the screw holes align. Some resistance is normal. The bypass cartridge is not keyed and will install in either direction.
- 11 Use a screwdriver to tighten the two (B) screws first and lastly tighten screw (A). **DO NOT** use a drill or impact driver to tighten the screws.

Accessing Water Heater Components

- 12 Locate the two (2) screws at the bottom of the cabinet cover. Use a Phillips screwdriver to remove the screws. Place screws aside in a safe place for reinstallation.
- 13 Lift cover up and away from cabinet to gain access to the water heater's internal components.

SERVICE (WETTED COMPONENTS)

Removing Bypass Valve

- 14 Locate the bypass valve on the left side of the water heater as shown in Figure 185.

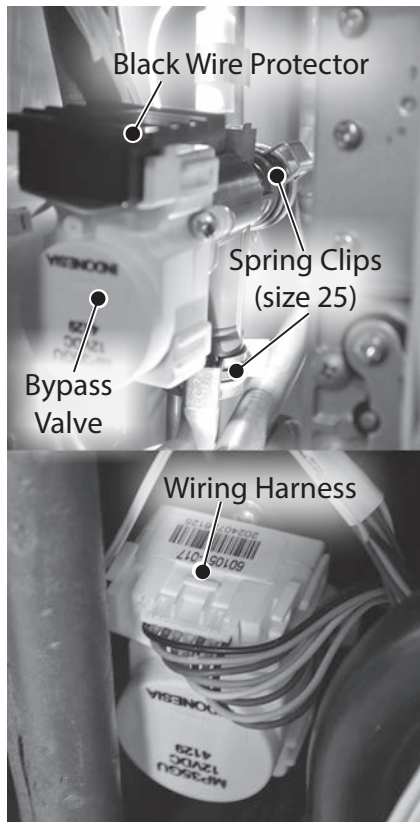

Figure 185 - Bypass valve

Remove the black wire protector from bypass valve and place it aside in a safe place for reinstallation. Disconnect the wiring harness from the valve.

⚠ CAUTION! Water may still be present in the valve assembly. Place a rag under the valve connection points to prevent water from escaping into the water heater cabinet.

- 15 Remove the two (2) spring clips (size 25) securing the bypass valve to the piping system. Place the spring clips aside in a safe place for reinstallation.

- 16 Remove the bypass valve from the piping system and dispose of properly.

Installing New Bypass Valve

- 17 Locate the two O-rings on the exposed water pipe connections as shown in Figure 186 and remove them. Dispose of O-rings properly.

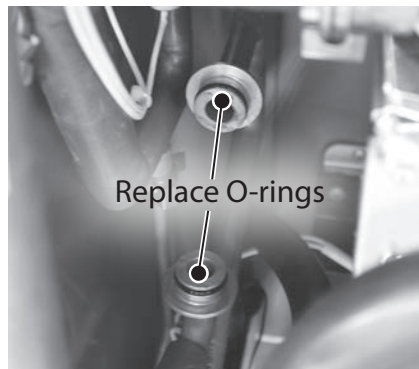

Figure 186 - Replace exposed O-rings

- 18 Locate the two (2) O-rings provided in the kit.
- 19 Install new O-rings to exposed water pipe connections.

NOTICE: Handle with care and verify lubricant has been applied to O-rings and O-rings are not dirty or damaged.

- 20 Locate the new bypass valve provided in the kit. Carefully install bypass valve to pipe connections.
- 21 Locate the two (2) spring clips previously removed in **Step 15**. Install spring clips to bypass valve, securing it to piping connections. Verify water connections are tight and will not leak.
- 22 Reconnect wiring harness to bypass valve. Confirm wiring connection is secure. Reinstall the black wire protector removed in **Step 14**.

Checking for Water Leaks

- 23 Turn **ON** the cold water supply to the water heater at the cold inlet valve. The system will fully pressurize and any leaks at water connections will be apparent. Correct any leaks immediately and dry water heater cabinet with a rag.

Returning Water Heater to Operation

- 24 Replace the cabinet cover and secure with the screws previously removed in **Step 12**.
- 25 Turn **ON** the gas supply to the water heater at the manual gas shut off valve.
- 26 Restore power to the water heater. The water heater is now ready for operation.

SERVICE (WETTED COMPONENTS)

Water Outlet Assembly

Kit 100390057 Contains:

- Outlet Assembly
- O-ring (17.8 x 2.4)
- O-ring (3.8 x 1.9)
- Kit Instructions

IMPORTANT: Use only factory authorized replacement parts. **DO NOT USE ELECTRIC SCREWDRIVERS OR DRILLS, HAND TIGHTEN ALL SCREWS TO PREVENT OVER TIGHTENING.** If you lack the necessary skills to properly perform the installation, you should not proceed, but get help from a qualified service technician.

Tools and Materials Required:

- Phillips Screwdriver
- Thread Sealant/Pipe Dope
- Towel or Rag
- Bucket or Pan
- Safety Gloves

Preparing Water Heater for Service

- 1 Disconnect power to the water heater by unplugging it or by turning off the circuit at the breaker box, as appropriate. The power button on the water heater and remote **DOES NOT** disconnect power to the water heater. You must physically disconnect power to the water heater.
- 2 Shut **OFF** the gas supply to the water heater at the manual gas shut off valve.
- 3 Shut **OFF** the cold water supply to the water heater at the cold inlet valve.
- 4 Open all hot water fixtures in the house. When the residual water flow has ceased, close all hot water fixtures. This will depressurize the water heater.

Draining the Water Heater

- 5 Drain the X3®/Bypass Cartridge. Place a bucket or pan underneath cartridge to collect water during removal.
- 6 Locate the three (3) screws securing the X3®/Bypass cartridge as shown in Figure 187. Remove the (A) M4-12mm screw and the two (B) M4-25mm screws from cartridge. Place screws aside in a safe place for reinstallation.

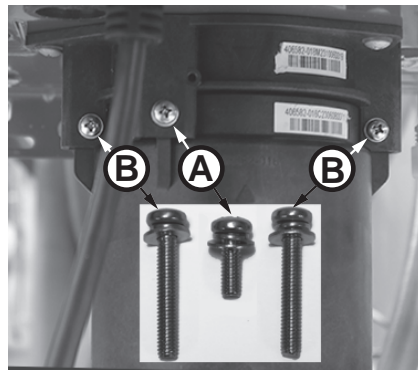

Figure 187 - Identify cartridge screws

- 7 Pull down to remove the cartridge from the water heater. Wait a few minutes to ensure all water has completely drained.
- 8 Locate and remove the inlet filter as shown in Figure 188 to drain any residual water left in the system.

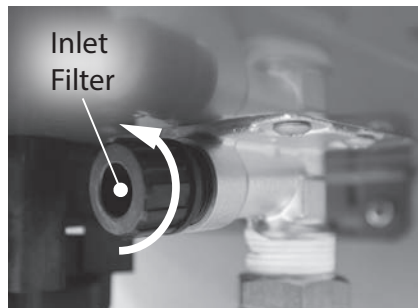

Figure 188 - Locate and remove inlet filter

- 9 Once the water heater has been adequately drained, reinstall inlet filter to water heater and tighten by hand. Confirm inlet filter is secured to water heater.

- 10 Reinstall the cartridge to the water heater. Insert the cartridge into manifold and secure with the two (2) long screws and one (1) short screw previously set aside in Step 6.

NOTICE: The X3® cartridge is keyed to only install in one direction. Align the ▲ on the cartridge with the ▼ on the manifold (the arrows will be facing the backside of the water heater). When inserting the cartridge, push up until the screw holes align. Some resistance is normal. The bypass cartridge is not keyed and will install in either direction.

- 11 Insert and snug all three (3) screws by hand. Use a screwdriver to tighten the two (B) screws first and lastly tighten screw (A). **DO NOT** use a drill or impact driver to tighten the screws.
- 12 Disconnect the hot water line to the hot outlet assembly.

Accessing Water Heater Components

- 13 Locate the two (2) screws at the bottom of the cabinet cover. Use a Phillips screwdriver to remove the screws. Place screws aside in a safe place for reinstallation.
- 14 Lift cover up and away from cabinet to gain access to the water heater's internal components

SERVICE (WETTED COMPONENTS)

Removing the Outlet Assembly

15 Locate the C clip securing the outlet assembly to the water piping. Remove the two screws securing C clip. Place screws and C clip aside in a safe place for reinstallation. See Figure 189.

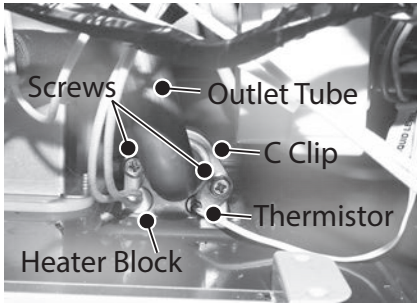

Figure 189 - Removing C clip and screws

⚠ CAUTION! Water may still be present in the valve assembly. Place a rag under the valve connection points to prevent water from escaping into the water heater cabinet.

16 Pull the heater block and thermistor from the base of the outlet assembly and set aside for reinstallation.

17 Locate the three (3) screws securing the outlet assembly to the base of the water heater. Use a Phillips screwdriver to remove the screws. Place screws aside in a safe place for reinstallation. See Figure 190.

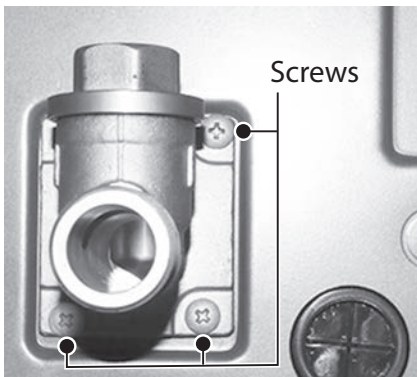

Figure 190 - Outlet assembly screw location

18 Disconnect outlet assembly from water piping and remove the old outlet assembly from the water heater. Dispose of outlet assembly properly.

Installing New Outlet assembly

19 Locate the new outlet assembly and large O-ring (17.8 x 2.4) provided in the kit.

20 Install the new large O-ring to water piping connection as shown in Figure 191.

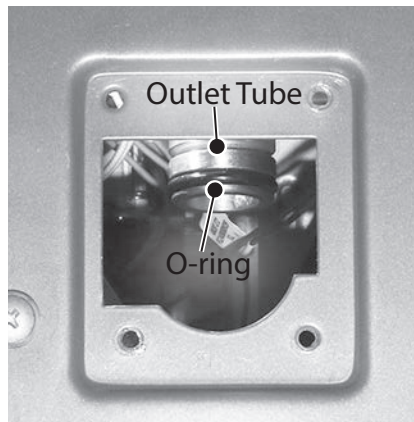

Figure 191 - Installing O-ring to water piping

NOTICE: Handle with care and verify lubricant has been applied to O-rings and O-rings are not dirty or damaged.

21 Place the new outlet assembly in the water heater and secure from below with the screws removed in **Step 17**.

22 Locate the small O-ring (3.8 x 1.9) provided in the kit. Place the O-ring over the thermistor and install it in the base of the outlet assembly. See Figure 192.

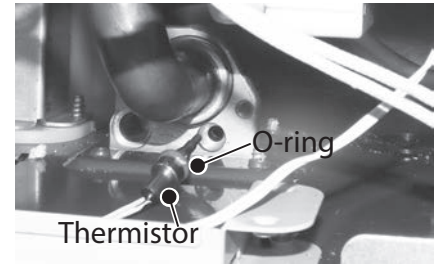

Figure 192 - Installing O-ring to thermistor

23 Reinstall the heater block to the base of the outlet assembly. Secure heater block and thermistor with C clip and two screws previously removed in **Step 15**. Verify water connections are tight and will not leak.

24 Reconnect the hot water line disconnected in **Step 12**. Use thread sealant tape or pipe dope when making the connection.

Checking for Water Leaks

25 Turn **ON** the cold water supply to the water heater at the cold inlet valve. The system will fully pressurize and any leaks at water connections will be apparent. Correct any leaks immediately and dry water heater cabinet with a rag.

Returning Water Heater to Operation

26 Replace the cabinet cover and secure with the screws previously removed in **Step 13**.

27 Turn **ON** the gas supply to the water heater at the manual gas shut off valve.

28 Restore power to the water heater. The water heater is now ready for operation.

SERVICE (WETTED COMPONENTS)

Water Tubing

Kit 100389979 (T1) Contains:

- Inlet Manifold Tube
- (2x) O-ring (15.5 x 2.5 NBR)
- Kit Instructions

Kit 100389980 (T2) Contains:

- Outlet Manifold Tube
- (1x) O-ring (15.5 x 2.5 NBR)
- (1x) O-ring (15.5 x 2.5 EPDM)
- Kit Instructions

Kit 100390051 (T3) Contains:

- Secondary HEX Inlet Tube
- (3x) O-ring (15.5 x 2.5 NBR)
- Kit Instructions

Kit 100390056 (T4) Contains:

- Primary HEX Outlet Tube
- (2x) O-ring (15.5 x 2.5 NBR)
- (1x) O-ring (17.8 x 2.4 NBR)
- (1x) O-ring (3.8 x 1.9 NBR)
- Kit Instructions

Kit 100390053 (T5) Contains:

- HEX Assembly Tube
- (2x) O-ring (15.5 x 2.5 NBR)
- (2x) O-ring (5.8 x 1.9 EPN)
- Kit Instructions

Kit 100390058 (T6) Contains:

- Drain Tube
- (2x) O-ring (5.8 x 1.9 EPN)
- Kit Instructions

IMPORTANT: Use only factory authorized replacement parts. **DO NOT USE ELECTRIC SCREWDRIVERS OR DRILLS, HAND TIGHTEN ALL SCREWS TO PREVENT OVERTIGHTENING.** If you lack the necessary skills to properly perform the installation, you should not proceed, but get help from a qualified service technician.

Tools and Materials Required:

- Phillips Screwdriver
- Bucket or Pan
- Towel or Rag
- Safety Gloves

(T1-T6) Preparing Water Heater for Service

- 1 Disconnect power to the water heater by unplugging it or by turning off the circuit at the breaker box, as appropriate. The power button on the water heater and remote

DOES NOT disconnect power to the water heater. You must physically disconnect power to the water heater.

- 2 Shut **OFF** the cold water supply to the water heater at the cold inlet valve.

- 3 Open all hot water fixtures in the house. When the residual water flow has ceased, close all hot water fixtures. This will depressurize the water heater.

(T1-T6) Draining the Water Heater

- 4 Drain the X3®/Bypass Cartridge. Place a bucket or pan underneath cartridge to collect water during removal.

- 5 Locate the three (3) screws securing the X3®/Bypass cartridge as shown in Figure 193. Remove the **(A)** M4-12mm screw and the two **(B)** M4-25mm screws from cartridge. Place screws aside in a safe place for reinstallation.

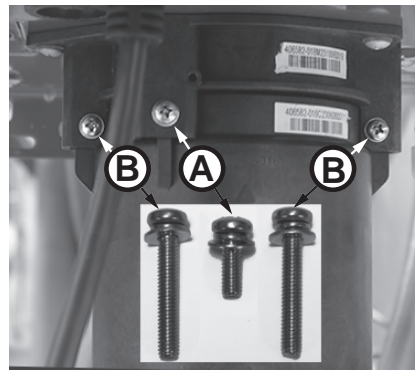

Figure 193 - Identify cartridge screws

- 6 Pull down to remove the cartridge from the water heater. Wait a few minutes to ensure all water has completely drained.

- 7 Locate and remove the inlet filter as shown in Figure 194 to drain any residual water left in the system. Place a bucket or pan underneath inlet filter to collect water during removal.

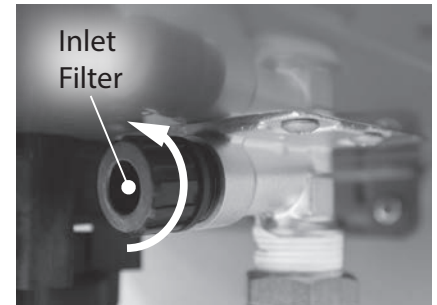

Figure 194 - Removing the inlet filter

- 8 Once the water heater has been adequately drained, reinstall inlet filter to water heater and tighten by hand. Confirm inlet filter is secured to water heater.

- 9 Reinstall the cartridge to the water heater. Locate the screws previously removed in **Step 5**. Insert and snug all three (3) screws by hand.

NOTICE: The X3® cartridge is keyed to only install in one direction. Align the **(▲)** on the cartridge with the **(▼)** on the manifold (the arrows will be facing the backside of the water heater). When inserting the cartridge, push up until the screw holes align. Some resistance is normal. The bypass cartridge is not keyed and will install in either direction.

- 10 Use a screwdriver to tighten the two **(B)** screws first and lastly tighten screw **(A)**. **DO NOT** use a drill or impact driver to tighten the screws.

SERVICE (WETTED COMPONENTS)

(T1-T6) Accessing Water Heater Components

11 Locate the two (2) screws at the bottom of the cabinet cover. Use a Phillips screwdriver to remove the screws. Place screws aside in a safe place for reinstallation.

12 Lift cover up and away from cabinet to gain access to the water heater's internal components.

13 Locate the User Interface Module (UIM) and bracket. Remove the four screws securing bracket to the water heater. Place screws aside in a safe place for reinstallation. Allow UIM and bracket to rest below water heater for easier access.

NOTICE: Use the parts diagram (Figure 195) on page 99 as a guide to assist in removing and replacing water tubing assemblies.

IMPORTANT! When tube replacement is complete, proceed to the "Checking for Water Leaks" section.

(T1) Replacing Inlet Manifold Tube (Kit 100389979)

1 Remove spring clips (S1 & S2) from manifold assembly (P1) and flow control valve (P2). Disconnect inlet manifold tube (T1) and dispose of properly.

2 Install new O-rings (R1 & R2) to new inlet manifold tube. Secure new inlet manifold tube to manifold assembly (P1) and flow control valve (P2) with spring clips (S1 & S2).

(T2) Replacing Outlet Manifold Tube (Kit 100389980)

1 Remove spring clips (S3 & S4) from manifold assembly (P1) and secondary HEX inlet tube (T3). Remove heater block from tube. Disconnect outlet manifold tube (T2) and dispose of properly.

2 Install new "EPDM" O-ring (R3) to manifold assembly (P1). Install new "NBR" O-ring (R4) to new outlet manifold tube. Secure new outlet manifold tube to manifold assembly (P1) and secondary HEX inlet tube (T3) with spring clips (S3 & S4). Install heater block.

(T3) Replacing Secondary HEX Inlet Tube (Kit 100390051)

1 Remove spring clips (S4, S5 & S6) from outlet manifold tube (T2), bypass valve (P5) and secondary HEX inlet. Remove heater block from tube. Disconnect secondary HEX inlet tube (T3) and dispose of properly.

2 Install new O-ring (R4) to outlet manifold tube (T2).

3 Install new O-rings (R5 & R6) to new secondary HEX inlet tube connections. Secure new secondary HEX inlet tube to outlet manifold tube (T2), bypass valve (P5) and secondary HEX inlet with spring clips (S4, S5 & S6). Install heater block.

(T4) Replacing Primary HEX Outlet Tube (Kit 100390056)

1 Remove spring clips (S7 & S8) from bypass valve (P5) and primary HEX outlet.

2 Remove two screws and C clip (P8) securing primary HEX outlet tube (T4) to outlet assembly (P4).

3 Remove screw, bracket and outlet thermistor (P6) from primary HEX outlet tube (T4).

4 Remove thermostat (P7) and two heater blocks. Disconnect primary HEX outlet tube and dispose of properly.

5 Install new small O-rings (R7, R8) and new large O-ring (R9) to new primary HEX outlet tube connections. Secure new primary HEX outlet tube to bypass valve (P5) and primary HEX outlet with spring clips (S7 & S8). Secure new primary HEX outlet tube to outlet assembly (P4) with C clip (P8) and two screws.

6 Install new O-ring (R14) to outlet thermistor (P6). Install outlet thermistor (P6) and bracket to new primary HEX outlet tube and secure with screw.

7 Install thermostat (P7) and two heater blocks.

SERVICE (WETTED COMPONENTS)

(T5) Replacing HEX Assembly Tube (Kit 100390053)

- 1 Remove spring clips (S5 & S6) from bypass valve (P5) and secondary HEX inlet. Partially disconnect secondary HEX inlet tube (T3) for easier access to HEX assembly tube (T5).
- 2 Remove spring clips (S9, S10 & S11) from secondary HEX, primary HEX and drain tube (T6). Remove heater block from tube. Disconnect HEX assembly tube (T5) and dispose of properly.
- 3 Install new O-rings (R10 & R11) to new HEX assembly tube.
- 4 Install new O-ring (R12) to drain tube (T6).
- 5 Secure new HEX assembly tube to drain tube (T6) first. Secure with spring clip (S11).
- 6 Secure new HEX assembly tube to secondary HEX and primary HEX with spring clips (S9 & S10). Install heater block.
- 7 Secure secondary HEX inlet tube (T3) to bypass valve (P5) and secondary HEX inlet with spring clips (S5 & S6).

(T6) Replacing Drain Tube (Kit 100390058)

- 1 Remove spring clips (S11 & S12) from HEX assembly tube (T5) and condensate drain connection (P3). Disconnect drain tube (T6) and dispose of properly.
- 2 Install new O-rings (R12 & R13) to new drain tube. Secure new drain tube to HEX assembly tube (T5) and condensate drain connection (P3) with spring clips (S11 & S12).

(T1-T6) Checking for Water Leaks

Turn **ON** the cold water supply to the water heater at the cold inlet valve. The system will fully pressurize and any leaks at water connections will be apparent. Correct any leaks immediately and dry water heater cabinet with a rag.

(T1-T6) Returning Water Heater to Operation

Secure the User Interface Module (UIM) and bracket to water heater with the four screws previously removed in **Step 13** (page 1). Confirm all electrical connections are snug and properly routed behind bracket.

Replace the cabinet cover and secure with the screws previously removed in **Step 11** (page 1).

Restore power to water heater. The water heater is now ready for operation.

SERVICE (WETTED COMPONENTS)

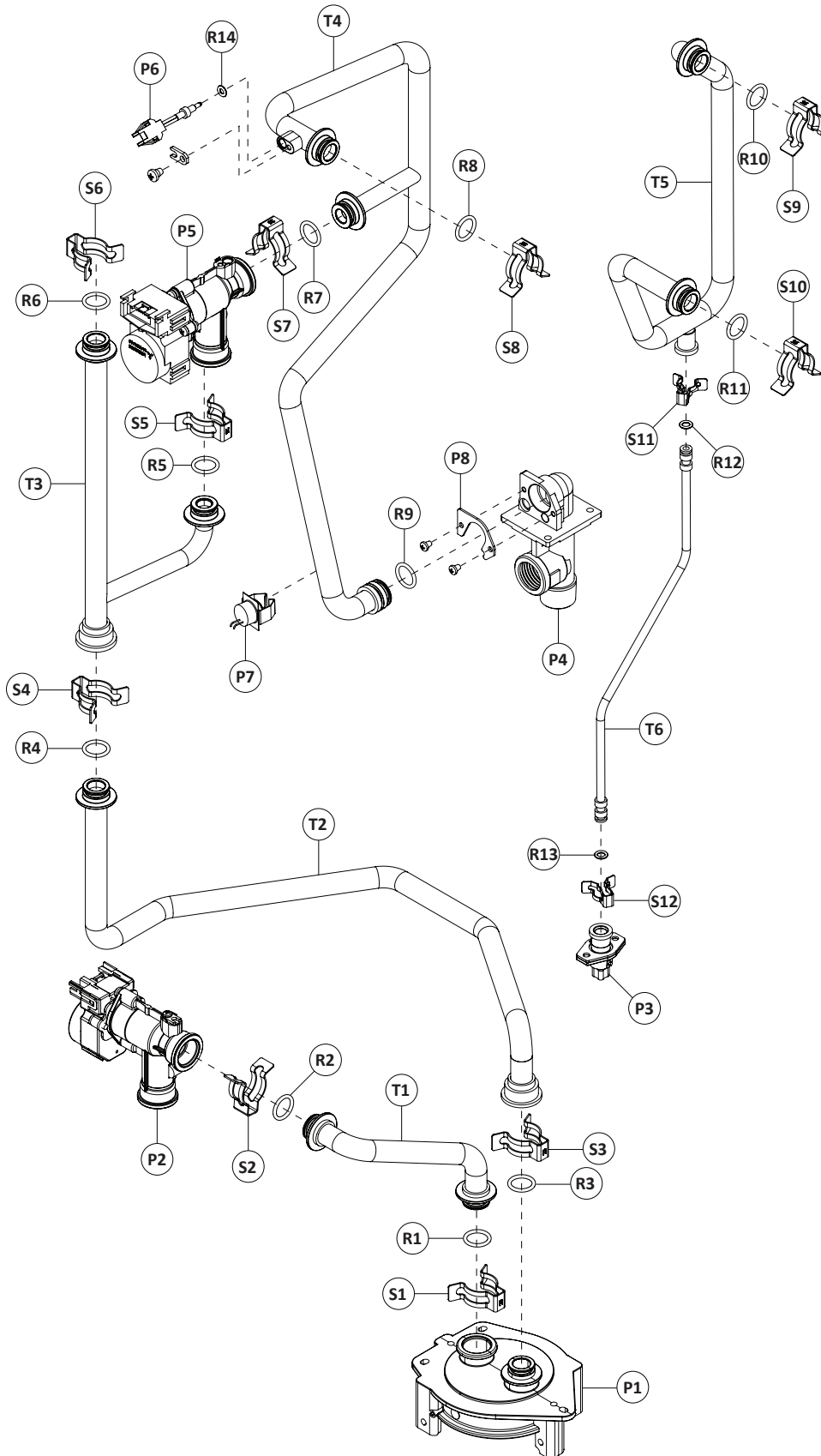

Figure 195 - Water tubing connection reference guide



SERVICE (WETTED COMPONENTS)

Condensate Trap

Kit 100390066 Contains:

- Condensate Trap
- Condensate Hose
- Kit Instructions

IMPORTANT: Use only factory authorized replacement parts. **DO NOT USE ELECTRIC SCREWDRIVERS OR DRILLS, HAND TIGHTEN ALL SCREWS TO PREVENT OVER TIGHTENING.** If you lack the necessary skills to properly perform the installation, you should not proceed, but get help from a qualified service technician.

Tools and Materials Required:

- Phillips Screwdriver
- Flat Head Screwdriver
- Towel or Rag
- Bucket or Pan
- Safety Gloves

Preparing Water Heater for Service

- 1 Disconnect power to the water heater by unplugging it or by turning off the circuit at the breaker box, as appropriate. The power button on the water heater and remote **DOES NOT** disconnect power to the water heater. You must physically disconnect power to the water heater.
- 2 Shut **OFF** the gas supply to the water heater at the manual gas shut off valve.
- 3 Shut **OFF** the cold water supply to the water heater at the cold inlet valve.

Accessing Condensate Trap

- 4 Locate the two (2) screws at the bottom of the cabinet cover. Use a Phillips screwdriver to remove the screws. Place screws aside in a safe place for reinstallation.

- 5 Lift cover up and away from cabinet to gain access to the water heater's internal components.

- 6 Locate the User Interface Module (UIM) and bracket. Remove the four screws securing bracket to the water heater. Place screws aside in a safe place for reinstallation.

NOTICE: UIM, bracket and wiring do not need to be disconnected. Allow UIM and bracket to rest below water heater for easy access to the condensate trap.

Removing Condensate Trap

- 7 The condensate trap drain is located underneath the water heater (see Figure 199). Disconnect drain piping to the plastic condensate drain. Place a bucket or pan underneath to collect water during removal.

- 8 Locate the condensate trap at the interior left rear side of the water heater.

- 9 Trace the yellow wires from the condensate trap to the red wiring harness and disconnect them. See Figure 196.

NOTICE: The harness uses a black security clip. Use a small flat blade screwdriver to remove and keep this clip for reinstallation. See Figure 1.

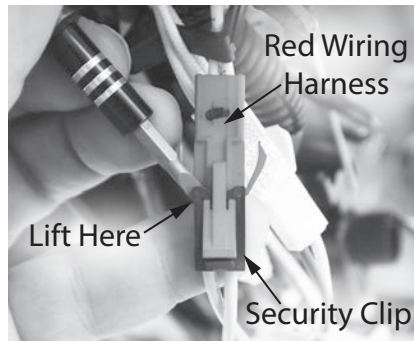

Figure 196 - Red wiring harness clip removal

- 10 Trace the black wires from the condensate trap to the wiring harness labeled "Liquid Level." Disconnect the wires. See Figure 197.

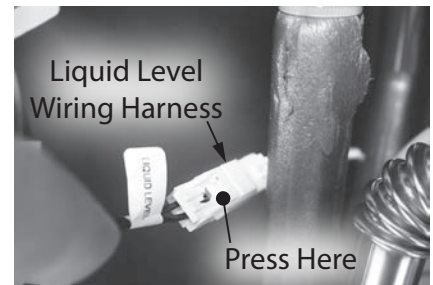

Figure 197 - Liquid level wiring harness location

- 11 Disconnect the black hose from the top of the condensate trap and then from the front of the heat exchanger (HEX). Compress the spring clamp and pull it down along with the black hose. Place the spring clamp aside in a safe place for reinstallation. Dispose of condensate hose properly. See Figure 198.

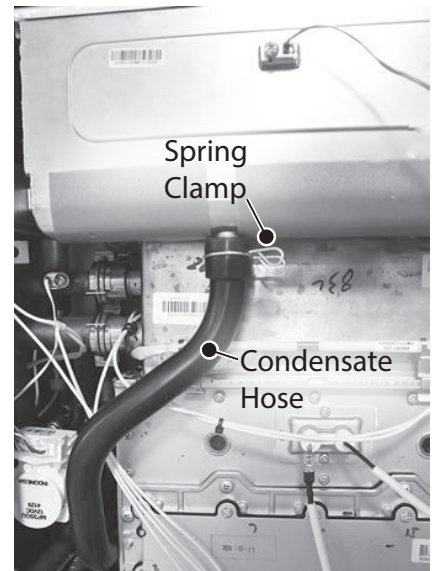

Figure 198 - Condensate hose removal

- 12 Locate the three (3) screws underneath the water heater securing the condensate trap. See Figure 199. Use a Phillips screwdriver to remove the screws. Place screws aside in a safe place for reinstallation.

SERVICE (WETTED COMPONENTS)

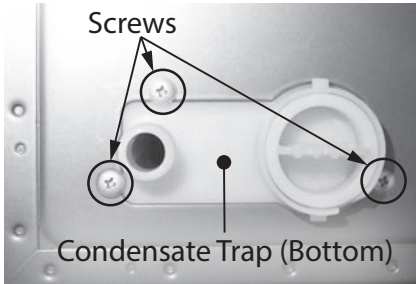

Figure 199 - Location of condensate trap screws.

- 13 Carefully remove the old condensate trap and dispose of it properly.

NOTICE: It is necessary to lift the condensate trap slightly and rotate it within the unit, so that the rounded section is in the front. Then tilt it forward so that the rounded section is on the bottom.

Installing New Condensate Trap

- 14 Locate the new condensate trap provided in the kit. Carefully install the new condensate trap.

NOTICE: When installing the new condensate trap, orient with the bottom facing the heater and the round section on the bottom.

- 15 Secure the condensate trap with the three (3) screws removed in **Step 12**.
- 16 Route the new red wiring harness to its mate disconnected in **Step 9**.

NOTICE: Carefully insert the black safety clip into the red wiring harness. See Figure 200.

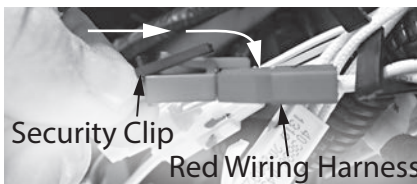

Figure 200 - Reconnecting the wiring harness

- 17 Route and reconnect the black wire to its mate removed in **Step 10**.

- 18 Locate the new condensate hose provided in the kit. Attach the hose to the heat exchanger. Make sure the hose is fully seated along with the spring clamp previously removed in **Step 11**. Reattach the other end of the hose to the top of the condensate trap. Check the connections to ensure they are fully seated to prevent leaks.

- 19 Reconnect the condensate drain piping removed in **Step 7**.

Returning Water Heater to Operation

- 20 Secure the User Interface Module (UIM) and bracket to water heater with the four screws previously removed in **Step 6**. Confirm all electrical connections are snug and properly routed behind bracket.
- 21 Replace the cabinet cover and secure with the screws previously removed in **Step 4**.
- 22 Turn **ON** the gas supply to the water heater at the manual gas shut off valve.
- 23 Turn **ON** the cold water supply to the water heater at the cold inlet valve.
- 24 Restore power to the water heater. The water heater is now ready for operation.

SERVICE (WETTED COMPONENTS)

Heat Exchanger (HEX) Drain

Kit 100390059 Contains:

- HEX Drain
- (1x) O-ring (5.8 x 1.9)
- Kit Instructions

IMPORTANT: Use only factory authorized replacement parts. **DO NOT USE ELECTRIC SCREWDRIVERS OR DRILLS, HAND TIGHTEN ALL SCREWS TO PREVENT OVERTIGHTENING.** If you lack the necessary skills to properly perform the installation, you should not proceed, but get help from a qualified service technician.

Tools and Materials Required:

- Phillips Screwdriver
- Bucket or Pan
- Towel or Rag
- Safety Gloves

Preparing Water Heater for Service

1 Disconnect power to the water heater by unplugging it or by turning off the circuit at the breaker box, as appropriate. The power button on the water heater and remote **DOES NOT** disconnect power to the water heater. You must physically disconnect power to the water heater.

2 Shut **OFF** the cold water supply to the water heater at the cold inlet valve.

3 Open all hot water fixtures in the house. When the residual water flow has ceased, close all hot water fixtures. This will depressurize the water heater.

Draining the Water Heater

4 Drain the X3®/Bypass Cartridge. Place a bucket or pan underneath cartridge to collect water during removal.

5 Locate the three (3) screws securing the X3®/Bypass cartridge as shown in Figure 201. Remove the **(A)** M4-12mm screw and the two **(B)** M4-25mm screws from cartridge. Place screws aside in a safe place for reinstallation.

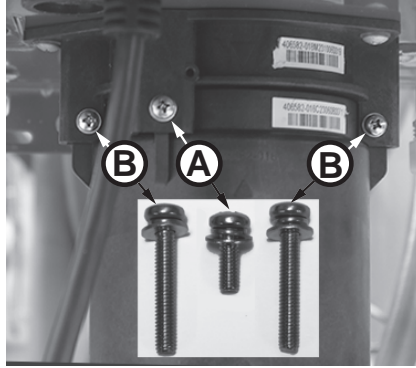

Figure 201 - Identify cartridge screws

6 Pull down to remove the cartridge from the water heater. Wait a few minutes to ensure all water has completely drained.

7 Locate and remove the inlet filter as shown in Figure 202 to drain any residual water left in the system. Place a bucket or pan underneath inlet filter to collect water during removal.

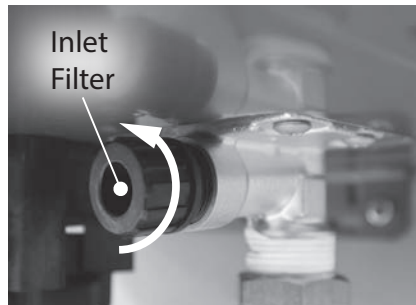

Figure 202 - Removing the inlet filter

8 Once the water heater has been adequately drained, reinstall inlet filter to water heater and tighten by hand. Confirm inlet filter is secured to water heater.

9 Reinstall the cartridge to the water heater. Locate the screws previously removed in **Step 5**. Insert and snug all three (3) screws by hand.

NOTICE: The X3® cartridge is keyed to only install in one direction. Align the ▲ on the cartridge with the ▼ on the manifold (the arrows will be facing the backside of the water heater). When inserting the cartridge, push up until the screw holes align. Some resistance is normal. The bypass cartridge is not keyed and will install in either direction.

10 Use a screwdriver to tighten the two **(B)** screws first and lastly tighten screw **(A)**. **DO NOT** use a drill or impact driver to tighten the screws.

11 Locate the heat exchanger (HEX) drain line underneath the water heater. See Figure 203. Remove the two screws securing the metal bracket and place them aside in a safe place for reinstallation.

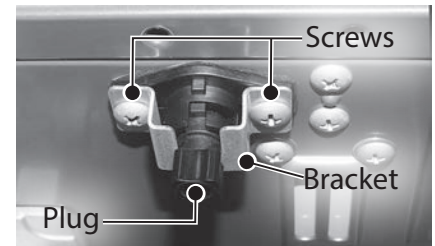

Figure 203 - HEX drain assembly

12 Remove the HEX drain plug by twisting and pulling down.

13 Allow the HEX drain to drain completely before moving to the next step.

Accessing Water Heater Components

14 Locate the two screws at the bottom of the cabinet cover. Use a Phillips screwdriver to remove the screws. Place screws aside in a safe place for reinstallation.

SERVICE (WETTED COMPONENTS)

- 15 Lift cover up and away from cabinet to gain access to the water heater's internal components.

Disconnecting HEX Drain Connection

- 16 Locate the HEX drain connected to the drain tube in the water heater (bottom left side). Remove spring clip securing HEX drain to drain tube and place it aside in a safe place for reinstallation. See Figure 203.

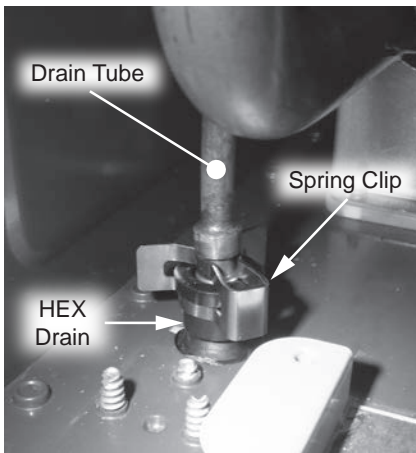

Figure 204 - Removing spring clip from HEX drain

- 17 The HEX drain can now be removed from the water heater. Dispose of HEX drain properly.

⚠ CAUTION! Water may still be present in the HEX drain. Place a rag under the drain connection point to prevent water from escaping into the water heater cabinet.

Installing New HEX Drain

- 18 Locate the new HEX drain and O-ring provided in the kit. Remove old O-ring from drain tube and install new O-ring as shown in Figure 204.

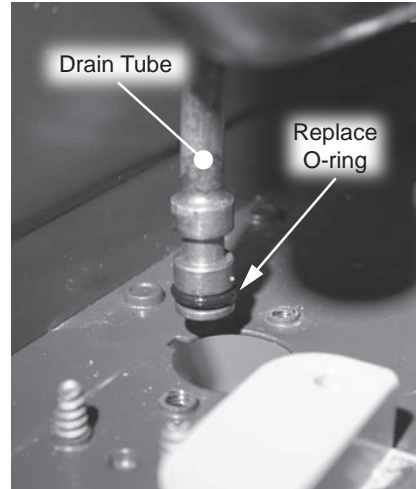

Figure 205 - Replacing drain tube O-ring

- 19 Install new HEX drain from underneath water heater cabinet and connect it to the drain tube. Orient HEX drain so screw holes in drain and water heater cabinet align.
- 20 Secure HEX drain to water heater cabinet with the bracket and two screws previously removed in Step 11.
- 21 Secure HEX drain to drain tube with the spring clip previously removed in Step 16.

Checking for Water Leaks

- 22 Turn **ON** the cold water supply to the water heater at the cold inlet valve. The system will fully pressurize and any leaks at water connections will be apparent. Correct any leaks immediately and dry water heater cabinet with a rag.

Returning Water Heater to Operation

- 23 Replace the cabinet cover and secure with the screws previously removed in Step 14.
- 24 Restore power to the water heater. The water heater is now ready for operation.

SERVICE (WETTED COMPONENTS)

Inlet Water Filter

Kit 100371184 Contains:

- Inlet Filter
- O-ring (2.4 x 12)
- Kit Instructions

IMPORTANT: Use only factory authorized replacement parts. **DO NOT USE ELECTRIC SCREWDRIVERS OR DRILLS, HAND TIGHTEN ALL SCREWS TO PREVENT OVER TIGHTENING.** If you lack the necessary skills to properly perform the installation, you should not proceed, but get help from a qualified service technician.

Tools and Materials Required:

- Pliers
- Towel or Rag
- Bucket or Pan
- Safety Gloves

Preparing Water Heater for Service

- 1 Disconnect power to the water heater by unplugging it or by turning off the circuit at the breaker box, as appropriate. The power button on the water heater and remote **DOES NOT** disconnect power to the water heater. You must physically disconnect power to the water heater.
- 2 Shut **OFF** the cold water supply to the water heater at the cold inlet valve.
- 3 Open all hot water fixtures in the house. When the residual water flow has ceased, close all hot water fixtures. This will depressurize the water heater.
- 4 Place a bucket or pan underneath the water heater to collect water during removal.

- 5 Remove the old inlet filter and dispose of it properly. Allow water heater to drain.

Installing New Inlet Filter

- 6 Locate the new inlet filter and O-ring provided in the kit. Install the O-ring to the inlet filter. See Figure 205.

NOTICE: Handle with care and verify lubricant has been applied to O-ring and O-ring is not dirty or damaged.

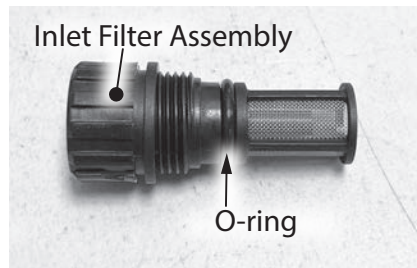

Figure 206 - O-ring location

- 7 Install the new inlet filter to water heater hand tight. Use caution and **DO NOT** damage the inlet filter.

Returning Water Heater to Operation

- 8 Turn **ON** the cold water supply to the water heater at the cold inlet valve. The system will fully pressurize and any leaks at water connections will be apparent. Correct any leaks immediately.
- 9 Restore power to the water heater. The water heater is now ready for operation.

SERVICE (FLUE & AIR INTAKE COMPONENTS)

Emission Port Cap

Kit 100371166 Contains:

- Emission Port Cap
- Kit Instructions

IMPORTANT: Use only factory authorized replacement parts. **DO NOT USE ELECTRIC SCREWDRIVERS OR DRILLS, HAND TIGHTEN ALL SCREWS TO PREVENT OVER TIGHTENING.** If you lack the necessary skills to properly perform the installation, you should not proceed, but get help from a qualified service technician.

Tools and Materials Required:

- Phillips Screwdriver
- Safety Gloves

WARNING!

This kit shall be installed by a qualified service agency in accordance with the manufacturer's instructions and all applicable codes and requirements of the authority having jurisdiction. The information in these instructions must be followed to minimize the risk of fire or explosion or to prevent property damage, personal injury or death. The qualified service agency is responsible for the proper installation of this kit.

Preparing Water Heater for Service

1 Disconnect power to the water heater by unplugging it or by turning off the circuit at the breaker box, as appropriate. The power button on the water heater and remote **DOES NOT** disconnect power to the water heater. You must physically disconnect power to the water heater.

2 Shut **OFF** the gas supply to the water heater at the manual gas shut off valve.

Removing Emissions Port Cap

3 Locate the emission port cap at the outlet exhaust port on the water heater as shown in Figure 206.

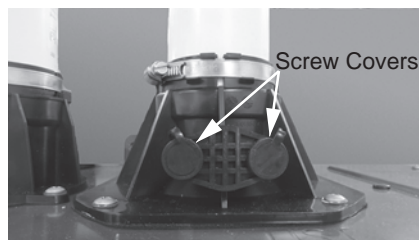

Figure 207 - Emission port location

4 Lift the screw covers to reveal the screws securing emission port cap to exhaust port.

5 Remove screws and set aside in a safe place for reinstallation. See Figure 207.

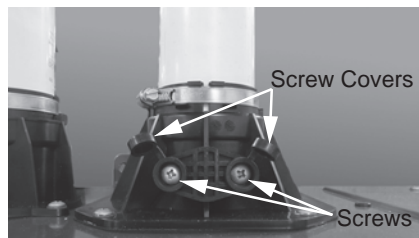

Figure 208 - Emissions port screw removal

6 Remove emission port cap and dispose of properly.

Installing New Emission Port Cap

7 Locate the new emission port cap provided in the kit.

8 Orient cap such that the plug can be inserted into the outlet exhaust port. Install cap to outlet exhaust port.

9 Locate screws previously removed in **Step 5**. Use screws to secure cap to outlet exhaust port. Cover screws with screw covers.

Checking for Gas Leaks

10 Turn **ON** the gas supply to the water heater at the manual gas shut off valve.

11 Restore power to the water heater.

12 Open all hot water fixtures in the house. This will initiate the call for heat at the water heater.

13 Check for leaks around the emission port cap. Use a small, soft-bristled brush to apply a hand dishwashing soap and water mixture (1 part soap to 15 parts water) or children's soap bubbles around the emissions port cap. If any leaks are detected (which will appear as small bubbles), resecure the emission port cap and recheck for leaks.

Returning the Water Heater to Operation

14 The water heater is ready for operation once there are no leaks detected at the emission port cap.

SERVICE (FLUE & AIR INTAKE COMPONENTS)

Flue & Air Intake O-Ring

Kit 100371185 Contains:

- O-Rings
- Kit Instructions

IMPORTANT: Use only factory authorized replacement parts. **DO NOT USE ELECTRIC SCREWDRIVERS OR DRILLS, HAND TIGHTEN ALL SCREWS TO PREVENT OVERTIGHTENING.** If you lack the necessary skills to properly perform the installation, you should not proceed, but get help from a qualified service technician.

Tools and Materials Required:

- Phillips Screwdriver
- Safety Gloves

WARNING!

This kit shall be installed by a qualified service agency in accordance with the manufacturer's instructions and all applicable codes and requirements of the authority having jurisdiction. The information in these instructions must be followed to minimize the risk of fire or explosion or to prevent property damage, personal injury or death. The qualified service agency is responsible for the proper installation of this kit.

Preparing Water Heater for Service

1 Disconnect power to the water heater by unplugging it or by turning off the circuit at the breaker box, as appropriate. The power button on the water heater and remote **DOES NOT** disconnect power to the water heater. You must physically disconnect power to the water heater.

2 Shut **OFF** the gas supply to the water heater at the manual gas shut off valve.

3 Locate the flue exhaust port and intake air port. See Figure 1.

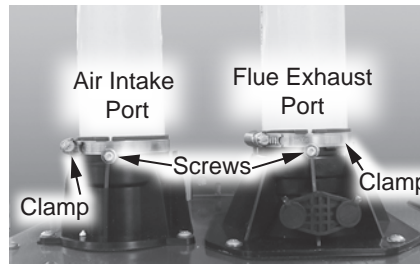

Figure 209 - Air intake port/Flue exhaust port location

4 Remove the two (2) self-tapping screws securing the intake air and exhaust piping to the ports. Place the screws aside in a safe place for reinstallation. See Figure 1.

5 Loosen the exhaust port and air intake clamps.

6 Disconnect the flue exhaust pipe from the exhaust port and air intake pipe from the air intake port.

Removing the Flue/Intake Air O-Rings

7 Remove and dispose of the old O-rings properly. See Figure 2.

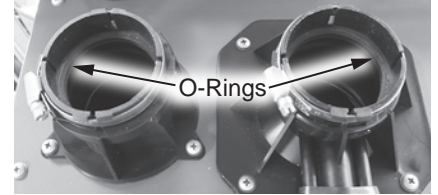

Figure 210 - O-ring locations

Replacing the Flue/Air Intake Clamps

8 Locate the new O-rings provided in the kit. Place a new O-ring in the intake air port and the exhaust port. The O-rings must be seated fully into the channel of each port with no distortion or puckering.

9 Reinstall the flue exhaust pipe to the exhaust port and air intake pipe to the air intake port removed in **Step 6**.

NOTICE: Before placing the pipes into the ports make sure they are clean and free from any debris.

10 Reinstall the two (2) screws removed in **Step 4**. See Figure 1.

11 Tighten the clamps at the exhaust and intake air ports to secure the piping. See Figure 1.

12 Turn **ON** the gas supply to the water heater at the manual gas shut off valve.

13 Restore power to the water heater.

SERVICE (FLUE & AIR INTAKE COMPONENTS)

Checking for Gas Leaks

- 14 Open all hot water fixtures in the house. This will initiate the call for heat at the water heater.
- 15 Check for leaks around the flue exhaust port. Use a small, soft-bristled brush to apply a hand dishwashing soap and water mixture (1 part soap to 15 parts water) or children's soap bubbles around the flue exhaust port. If any leaks are detected (which will appear as small bubbles), resecure the connection and recheck for leaks.
- 16 Close all hot water fixtures in the house once the check is complete.

Returning the Water Heater to Operation

- 17 The water heater is now ready for operation.



SERVICE (FLUE & AIR INTAKE COMPONENTS)

Flue & Air Intake Clamp

Kit 100371167 Contains:

- Clamps
- Kit Instructions

IMPORTANT: Use only factory authorized replacement parts. **DO NOT USE ELECTRIC SCREWDRIVERS OR DRILLS, HAND TIGHTEN ALL SCREWS TO PREVENT OVER TIGHTENING.** If you lack the necessary skills to properly perform the installation, you should not proceed, but get help from a qualified service technician.

Tools and Materials Required:

- Flathead Screwdriver
- Phillips head Screwdriver
- Safety Gloves

Preparing Water Heater for Service

1 Disconnect power to the water heater by unplugging it or by turning off the circuit at the breaker box, as appropriate. The power button on the water heater and remote **DOES NOT** disconnect power to the water heater. You must physically disconnect power to the water heater.

2 Locate the flue exhaust port and intake air port. See Figure 211.

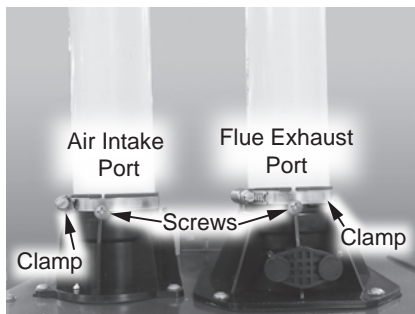

Figure 211 - Flue exhaust port and intake air port location

3 Remove the two (2) screws securing the intake air and exhaust piping to the ports. Place the screws aside in a safe place for reinstallation. See Figure 211.

Removing the Flue/Air Intake Clamps

4 Using a flathead screwdriver loosen the exhaust port and air intake clamps.

5 Disconnect the flue exhaust pipe from the exhaust port and air intake pipe from the air intake port.

6 Remove the clamps and dispose of them properly.

Replacing the Flue/Air Intake Clamps

7 Locate the new clamps provided in the kit. Place a new clamp over the intake air port and the exhaust port. Note the orientation of the clamps. See Figure 210.

8 Reinstall the flue exhaust pipe to the exhaust port and air intake pipe to the air intake port removed in **Step 5**.

NOTICE: Before placing the pipes into the ports make sure they are clean and free from any debris.

9 Reinstall the two (2) screws removed in **Step 3**. See Figure 211.

10 Tighten the clamps at the exhaust and intake air ports to secure the piping.

Returning Water Heater to Operation

11 Restore power to the water heater. The water heater is now ready for operation.

SERVICE (MASTER KITS)

Gasket Master Kit

Kit Contains:

- Ignitor & Flame Sensor Gasket (G1)
- Gas Manifold Gasket (G2)
- Burner Gasket (G3)
- Kit Instructions

IMPORTANT: Use only factory authorized replacement parts. **DO NOT USE ELECTRIC SCREWDRIVERS OR DRILLS, HAND TIGHTEN ALL SCREWS TO PREVENT OVER TIGHTENING.** If you lack the necessary skills to properly perform the installation, you should not proceed, but get help from a qualified service technician.

WARNING!

This kit shall be installed by a qualified service agency in accordance with the manufacturer's instructions and all applicable codes and requirements of the authority having jurisdiction. The information in these instructions must be followed to minimize the risk of fire or explosion or to prevent property damage, personal injury or death. The qualified service agency is responsible for the proper installation of this kit.

Tools and Materials Required:

- Phillips Screwdriver
- Towel or Rag
- Safety Gloves

NOTICE: Use the diagrams (Figure 212) on page 111 to reference the location of gaskets provided in the kit.

Part A

Preparing Water Heater for Service

- 1 Disconnect power to the water heater by unplugging it or by turning off the circuit at the breaker box, as appropriate. The power button on the water heater and remote **DOES NOT** disconnect power to the water heater. You must physically disconnect power to the water heater.
- 2 Shut **OFF** the gas supply to the water heater at the manual gas shut off valve.
- 3 Shut **OFF** the cold water supply to the water heater at the cold inlet valve.
- 4 Open all hot water fixtures in the house. When the residual water flow has ceased, close all hot water fixtures. This will depressurize the water heater.

Accessing Water Heater Components

- 5 Locate the two (2) screws at the bottom of the cabinet cover. Use a Phillips screwdriver to remove the screws. Place screws aside in a safe place for reinstallation.
- 6 Lift cover up and away from cabinet to gain access to the water heater's internal components.

The water heater is now ready to be serviced. Follow the instructions below to replace gaskets as needed.

Part B (G1):

Replacing Ignitor and Flame Sensor Gasket

- 1 Disconnect wire from flame sensor at the flame sensor rod. Disconnect ignitor wire from the ignitor assembly.

- 2 Remove the four screws securing the ignitor rod and flame sensor rod assembly to the burner assembly. Place screws aside in a safe place for reinstallation.

- 3 Remove ignitor rod and flame sensor rod assembly from burner assembly.

- 4 Use a plastic scraper to gently scrape old insulation gasket clean from ignitor rod and flame sensor rod assembly. Confirm assembly surface is free of any debris or leftover insulation.

IMPORTANT! DO NOT gouge or damage assembly surface when removing insulation gasket.

- 5 Locate gasket (G1) provided in the kit. Install new gasket to ignitor rod and flame sensor rod assembly.

- 6 Install ignitor rod and flame sensor rod assembly to burner assembly and connect wires.

- 7 Proceed to **Part C** if no other gaskets must be replaced.

Part B (G2):

Replacing Gas Manifold Gasket

- 1 Locate both green ground wires attached to gas manifold cover. Remove the two screws securing the green ground wires and place them aside in a safe place for reinstallation.

- 2 Locate the User Interface Module (UIM) and bracket. Remove the four screws securing bracket to the water heater. Place screws aside in a safe place for reinstallation. Allow UIM and bracket to rest below water heater for easier access.

- 3 Remove the two screws securing the ignitor assembly to the gas manifold. Place screws aside in a safe place for reinstallation.

SERVICE (MASTER KITS)

- 4 Disconnect wires and remove ignitor assembly from gas manifold. Place assembly aside in a safe place for reinstallation.
- 5 Remove the eight screws securing the gas manifold to the burner assembly. Place screws aside in a safe place for reinstallation.
- 6 Remove the four screws securing the gas manifold to the gas valve. Place screws aside in a safe place for reinstallation.
- 7 Remove gas manifold from burner assembly.
- 8 Remove the old gas manifold gasket. Confirm gas manifold surface is free of any debris.
- 9 Locate gasket (G2) provided in the kit. Install new gasket to gas manifold.

NOTICE: If also replacing Burner Assembly Gasket, proceed to **Step 8** in the following section, **Part B (G3)**.

- 10 Install gas manifold to burner assembly and gas valve.
- 11 Install ignitor assembly to gas manifold. Connect wires.
- 12 Secure the User Interface Module (UIM) and bracket to water heater. Confirm all electrical connections are snug and properly routed behind bracket.
- 13 Secure green ground wires to gas manifold cover.
- 14 Proceed to **Part C** if no other gaskets must be replaced.

Part B (G3):

Replacing Burner Assembly Gasket

- 1 Locate both green ground wires attached to gas manifold cover. Remove the two screws securing the green ground wires and place them aside in a safe place for reinstallation.
- 2 Locate the User Interface

Module (UIM) and bracket. Remove the four screws securing bracket to the water heater. Place screws aside in a safe place for reinstallation. Allow UIM and bracket to rest below water heater for easier access.

- 3 Remove the two screws securing the ignitor assembly to the gas manifold. Place screws aside in a safe place for reinstallation.
- 4 Disconnect wires and remove ignitor assembly from gas manifold. Place assembly aside in a safe place for reinstallation.
- 5 Remove the eight screws securing the gas manifold to the burner assembly. Place screws aside in a safe place for reinstallation.
- 6 Remove the four screws securing the gas manifold to the gas valve. Place screws aside in a safe place for reinstallation.
- 7 Remove gas manifold from burner assembly.
- 8 Remove the top nine screws and the bottom two screws securing burner assembly to heat exchanger assembly. Place screws aside in a safe place for reinstallation.
- 9 Remove burner assembly from heat exchanger assembly.
- 10 Use a plastic scraper to gently scrape old insulation gasket clean from burner assembly. Confirm assembly surface is free of any debris or leftover insulation.

IMPORTANT! DO NOT gouge or damage assembly surface when removing insulation gasket.

- 11 Locate gasket (G3) provided in the kit. Install new gasket to burner assembly.
- 12 Install burner assembly to heat exchanger assembly.
- 13 Install gas manifold to burner assembly and gas valve.
- 14 Install ignitor assembly to gas manifold. Connect wires.

- 15 Secure the User Interface Module (UIM) and bracket to water heater. Confirm all electrical connections are snug and properly routed behind bracket.
- 16 Secure green ground wires to gas manifold cover.
- 17 Proceed to **Part C** if no other gaskets must be replaced.

Part C

Checking for Gas Leaks

IMPORTANT! DO NOT apply liquids to any of the electrical connections when checking for gas leaks. Use a towel or rag to protect any electrical components.

- 1 Turn **ON** the cold water supply to the water heater at the cold inlet valve.
- 2 Turn **ON** the gas supply to the water heater at the manual gas shut off valve.
- 3 Restore power to the water heater. Open all hot water fixtures in the house. This will initiate the call for heat at the water heater.
- 4 Use code approved methods to check for leaks around all gas connection points. If any leaks are detected, resecure components and recheck for leaks.
- 5 Once no leaks have been confirmed, remove towel or rag from electrical connections if necessary.
- 6 Close all hot water fixtures in the house once the check is complete.

Returning Water Heater to Operation

Replace the cabinet cover and secure with the screws previously removed in **Part A, Step 5**.

The water heater is now ready for operation.

SERVICE (MASTER KITS)

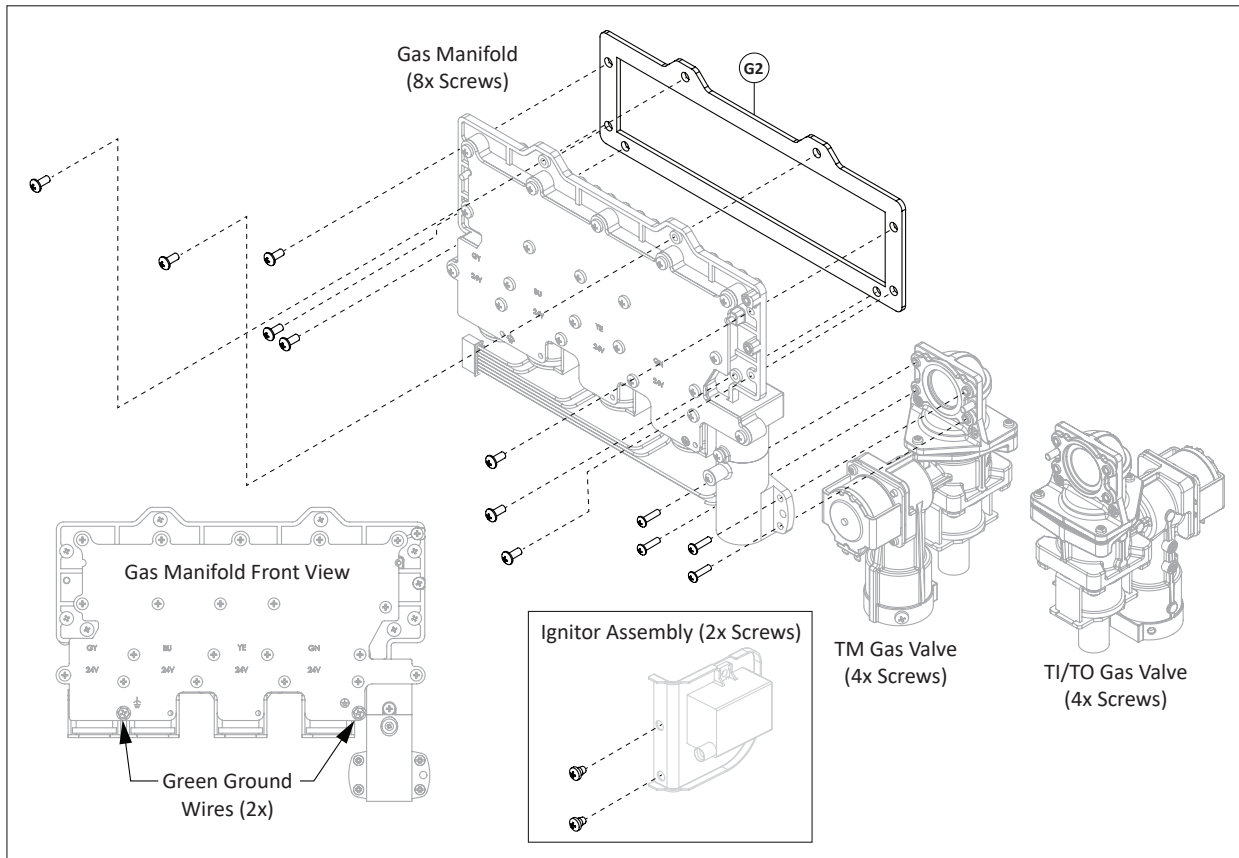
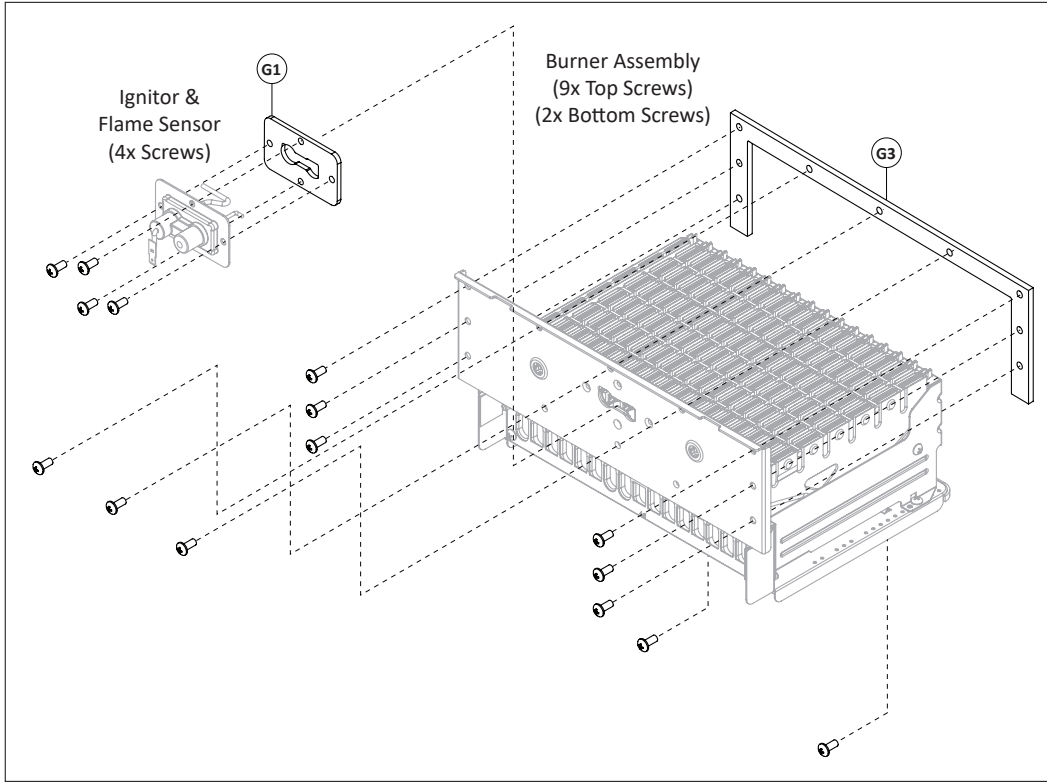

Figure 212 - Gasket reference guide



SERVICE (MASTER KITS)

Fastener Master Kit

IMPORTANT: Use only factory authorized replacement parts. **DO NOT USE ELECTRIC SCREWDRIVERS OR DRILLS, HAND TIGHTEN ALL SCREWS TO PREVENT OVERTIGHTENING.** If you lack the necessary skills to properly perform the installation, you should not proceed, but get help from a qualified service technician.

Tools and Materials Required:

- Phillips Screwdriver
- Bucket or Pan
- Towel or Rag
- Safety Gloves

NOTICE: Use the parts diagram (Figure 213) and the table provided on page 113 to reference the location of fasteners provided in the kit.

Preparing Water Heater for Service

1 Disconnect power to the water heater by unplugging it or by turning off the circuit at the breaker box, as appropriate. The power button on the water heater and remote **DOES NOT** disconnect power to the water heater. You must physically disconnect power to the water heater.

NOTICE: Proceed to **Step 5** if replacing fasteners "D3" and/or "E-G" only. Replacing these fasteners do not require a water leak check.

Draining the Water Heater (Fasteners A-C, D1 & D2 Only)

- 2** Shut **OFF** the cold water supply to the water heater at the cold inlet valve.
- 3** Open all hot water fixtures in the house. When the residual water flow has ceased, close all hot water fixtures. This will depressurize the water heater.
- 4** Drain the X3®/Bypass Cartridge and inlet filter. Place a bucket or pan underneath cartridge and inlet filter to collect water during removal. Install cartridge and inlet filter back to water heater and proceed.

Accessing Water Heater Components

- 5** Locate the two (2) screws at the bottom of the cabinet cover. Use a Phillips screwdriver to remove the screws. Place screws aside in a safe place for reinstallation.
- 6** Lift cover up and away from cabinet to gain access to the water heater's internal components.
- 7** Locate the User Interface Module (UIM) and bracket. Remove the four screws securing bracket to the water heater. Place screws aside in a safe place for reinstallation. Allow UIM and bracket to rest below water heater for easier access.

The water heater is now ready to be serviced. Replace fasteners as needed.

Once fasteners have been replaced, proceed to next applicable section.

Checking for Water Leaks (Fasteners A-C, D1 & D2 Only)

- 8** Turn **ON** the cold water supply to the water heater at the cold inlet valve. The system will fully pressurize and any leaks at water connections will be apparent. Correct any leaks immediately and dry water heater cabinet with a rag.

Returning Water Heater to Operation

- 9** Secure the User Interface Module (UIM) and bracket to water heater with the four screws previously removed in **Step 7**. Confirm all electrical connections are snug and properly routed behind bracket.
- 10** Replace the cabinet cover and secure with the screws previously removed in **Step 5**.

Restore power to water heater. The water heater is now ready for operation.

SERVICE (MASTER KITS)

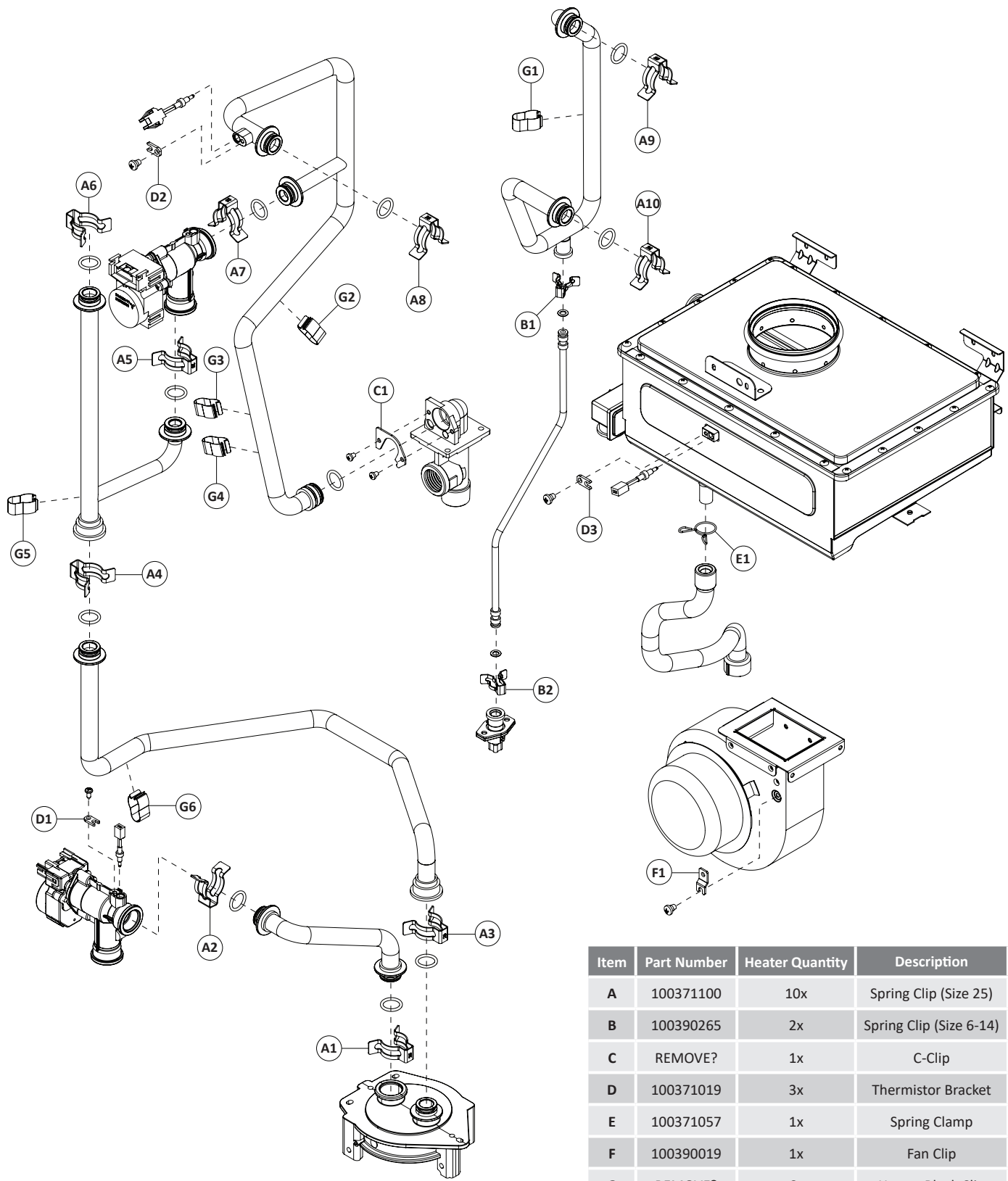

Item	Part Number	Heater Quantity	Description
A	100371100	10x	Spring Clip (Size 25)
B	100390265	2x	Spring Clip (Size 6-14)
C	REMOVE?	1x	C-Clip
D	100371019	3x	Thermistor Bracket
E	100371057	1x	Spring Clamp
F	100390019	1x	Fan Clip
G	REMOVE?	6x	Heater Block Clip

Figure 213 - Fastener reference guide

SERVICE



SERVICE (MASTER KITS)

O-Ring Master Kit

IMPORTANT: Use only factory authorized replacement parts. **DO NOT USE ELECTRIC SCREWDRIVERS OR DRILLS, HAND TIGHTEN ALL SCREWS TO PREVENT OVERTIGHTENING.** If you lack the necessary skills to properly perform the installation, you should not proceed, but get help from a qualified service technician.

WARNING!

This kit shall be installed by a qualified service agency in accordance with the manufacturer's instructions and all applicable codes and requirements of the authority having jurisdiction. The information in these instructions must be followed to minimize the risk of fire or explosion or to prevent property damage, personal injury or death. The qualified service agency is responsible for the proper installation of this kit.

NOTICE: Use the parts diagram (Figure 214) and the table provided on page 115 to reference the location of O-rings provided in the kit.

Preparing Water Heater for Service

1 Disconnect power to the water heater by unplugging it or by turning off the circuit at the breaker box, as appropriate. The power button on the water heater and remote **DOES NOT** disconnect power to the water heater. You must physically disconnect power to the water heater.

NOTICE: Proceed to **Step 6** if replacing O-ring "B2" only. Replacing this O-ring does not require a water leak or gas leak check.

Draining the Water Heater (O-rings A-F only)

- 2** Shut **OFF** the cold water supply to the water heater at the cold inlet valve.
- 3** Open all hot water fixtures in the house. When the residual water flow has ceased, close all hot water fixtures. This will depressurize the water heater.
- 4** Drain the X3®/Bypass Cartridge and inlet filter. Place a bucket or pan underneath cartridge and inlet filter to collect water during removal. Install cartridge and inlet filter back to water heater and proceed.

Shutting Off the Gas Supply (O-rings G only)

- 5** Shut **OFF** the gas supply to the water heater at the manual gas shut off valve.

Accessing Water Heater Components

- 6** Locate the two (2) screws at the bottom of the cabinet cover. Use a Phillips screwdriver to remove the screws. Place screws aside in a safe place for reinstallation.
- 7** Lift cover up and away from cabinet to gain access to the water heater's internal components.

The water heater is now ready to be serviced. Replace O-Rings as needed.

NOTICE: Handle with care and verify lubricant has been applied to O-rings and O-rings are not dirty or damaged.

Checking for Water Leaks (O-rings A-F only)

- 8** Turn **ON** the cold water supply to the water heater at the cold inlet valve. The system will fully pressurize and any leaks at water connections will be apparent. Correct any leaks immediately and dry water heater cabinet with a rag.
- 9** Restore power to the water heater and proceed to the "Returning Water Heater to Operation" section.

Checking for Gas Leaks (O-rings G only)

IMPORTANT! DO NOT apply liquids to any of the electrical connections when checking for gas leaks. Use a towel or rag to protect any electrical components.

- 10** Turn **ON** the gas supply to the water heater at the manual gas shut off valve.
- 11** Restore power to the water heater. Open all hot water fixtures in the house. This will initiate the call for heat at the water heater.
- 12** Use code approved methods to check for leaks around all gas connection points. If any leaks are detected, resecure components and recheck for leaks.
- 13** Once no leaks have been confirmed, remove towel or rag from electrical connections if necessary.
- 14** Close all hot water fixtures in the house once the check is complete. Proceed to the following section.

Returning Water Heater to Operation

- 15** Replace the cabinet cover and secure with the screws previously removed in **Step 6**. The water heater is now ready for operation.

SERVICE (MASTER KITS)

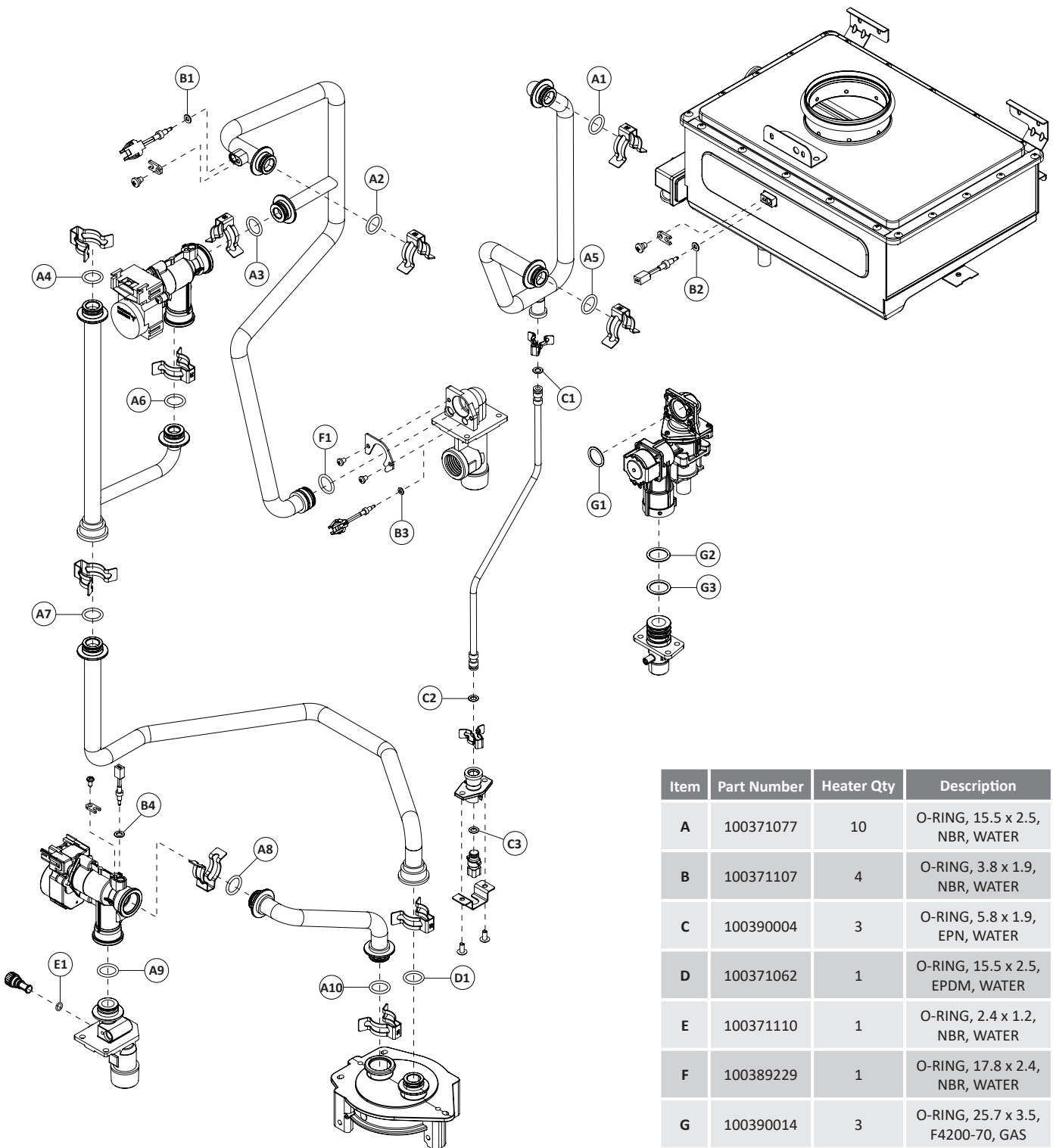

Figure 214 - O-ring reference guide

SERVICE



COMPONENTS

Internal Component View (B)

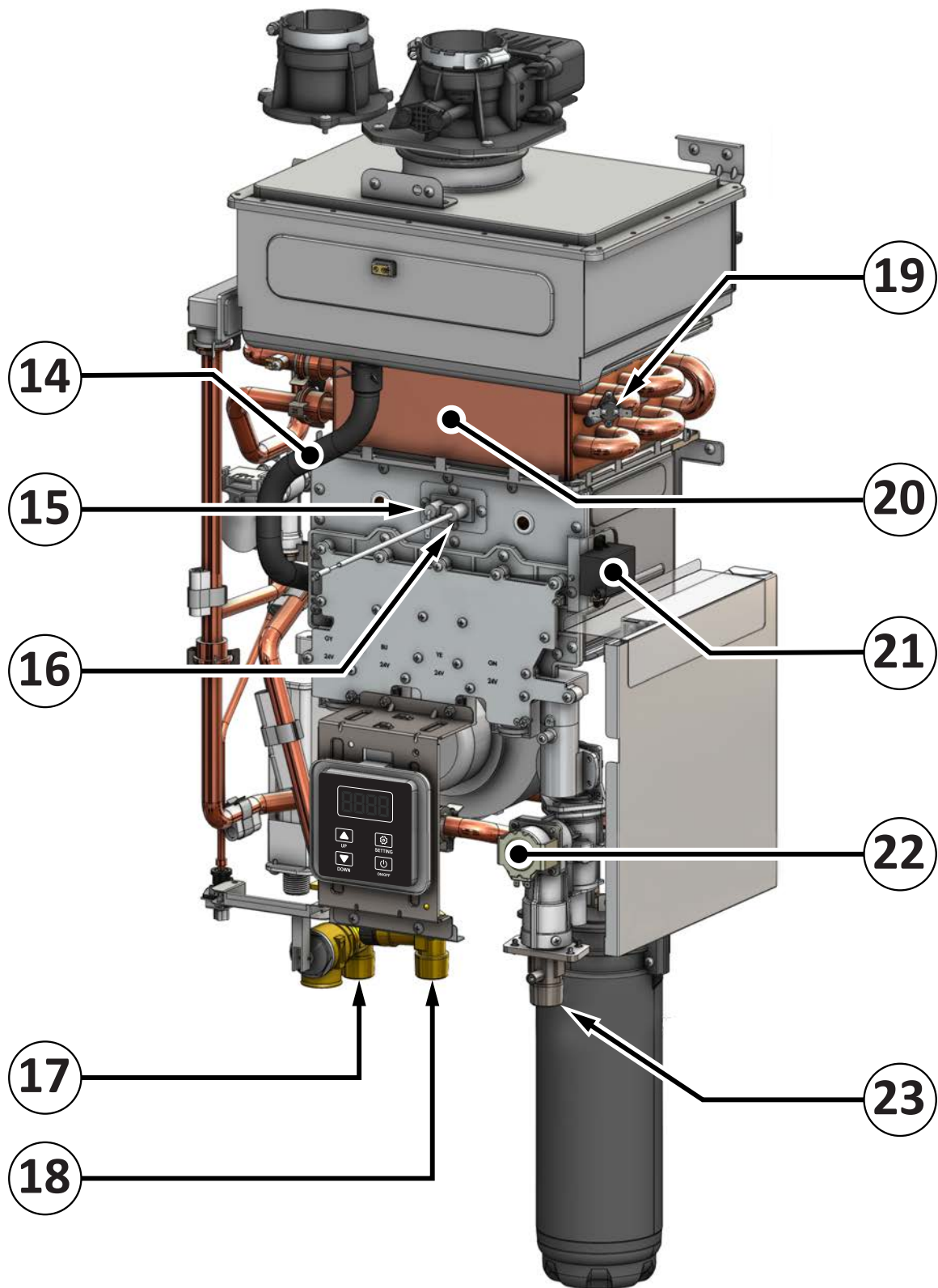
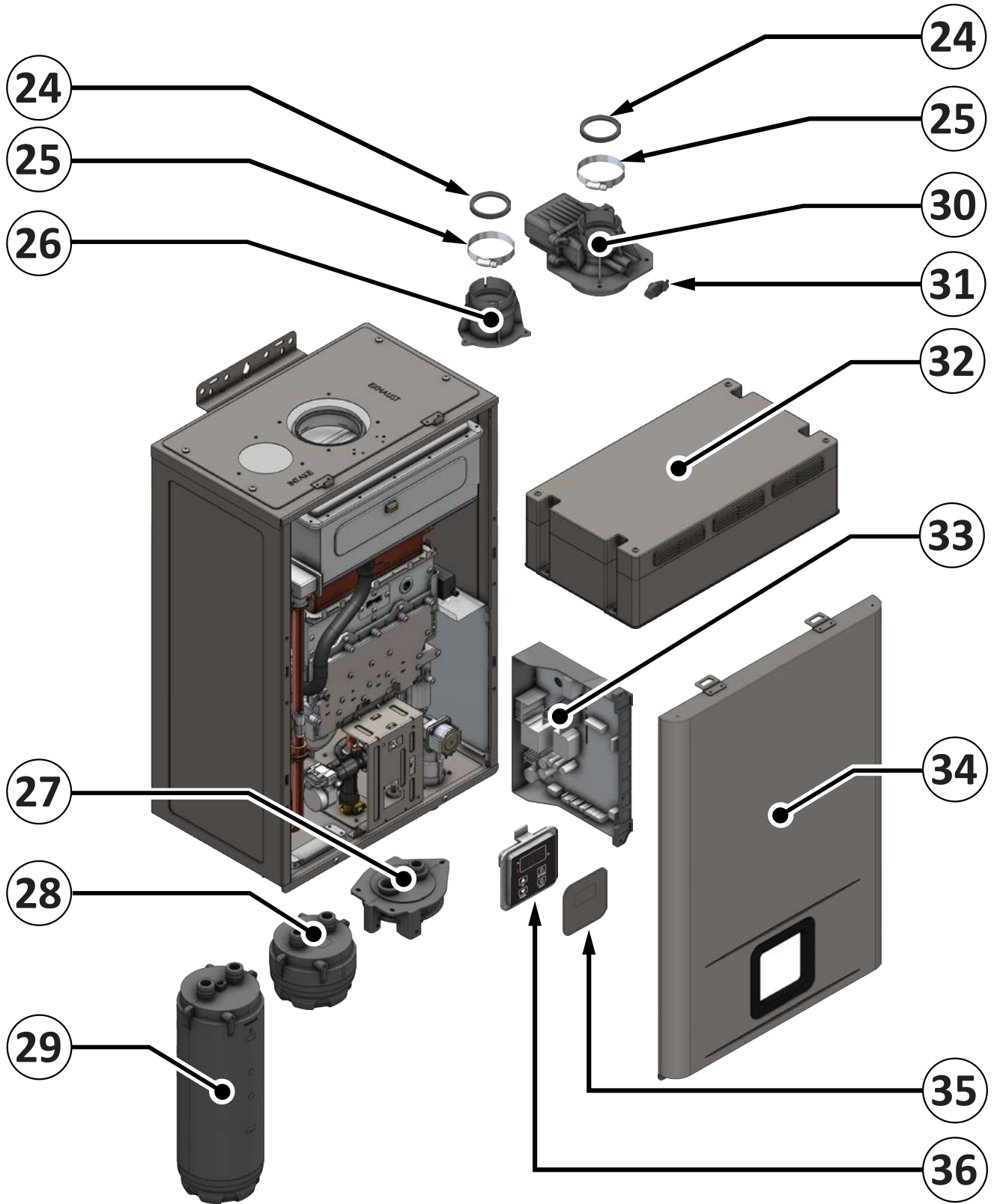

Figure 216 - Internal Component View (B)



COMPONENTS

External Component View



COMPONENTS

Figure 217 - External Component View (B)



COMPONENTS

Internal / External Component List

Table 18: Internal / External Component List

Item Number	Component List
1	Water Tube Retainer Clip
2	Freeze Protection
3	Bypass Water Valve
4	Blower
5	Condensate Trap
6	Main Water Valve
7	Condensate Drain Connection
8	Heat Exchanger Drain Connection
9	Pressure Relief Valve
10	Secondary Heat Exchanger
11	Burner
12	Gas Manifold
13	Gas Manifold Cover
14	Condensate Tubing
15	Flame Sensor Rod
16	Ignitor Rod
17	Hot Water Outlet
18	Cold Water Inlet
19	Hi-Limit Switch
20	Primary Heat Exchanger
21	Ignitor Assembly
22	Gas Valve
23	3/4" Gas Connection
24	Flue & Air Intake O-Ring
25	Flue & Air Intake Clamp
26	Intake Connection
27	Cartridge Manifold (X3® or Bypass)
28	Bypass Cartridge
29	X3® Cartridge
30	Exhaust Connection
31	Emission Port Cap
32	Outdoor Vent Cap*
33	Printed Circuit Board (PCB)
34	Front Cover
35	User Interface Module (UIM) Cover*
36	User Interface Module (UIM)

*Components for outdoor applications only.



DIAGRAMS

Electrical Wiring Diagram

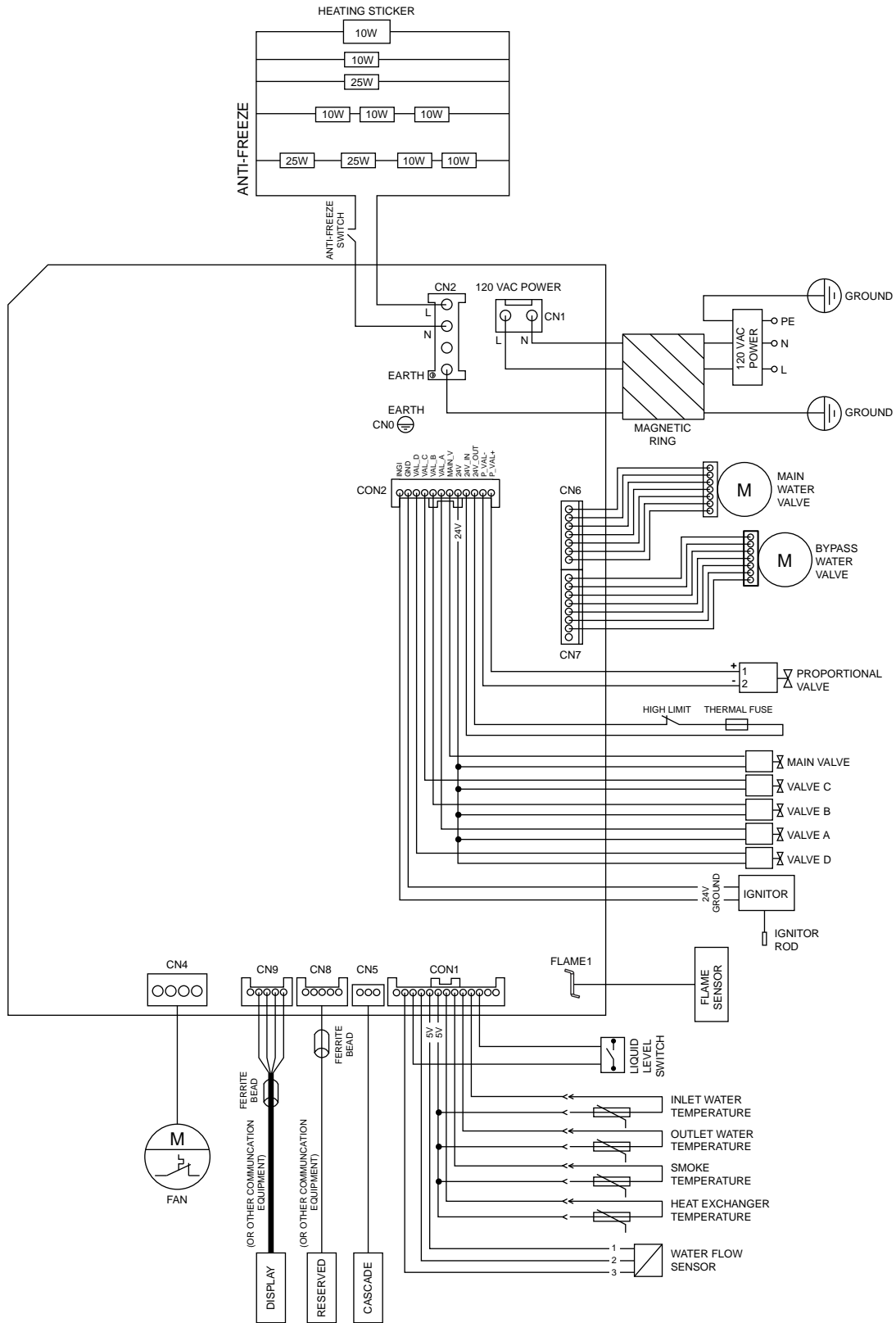

Figure 218 - Electrical wiring diagram

DIAGRAMS

Thermistor Resistance Vs Temperature Charts

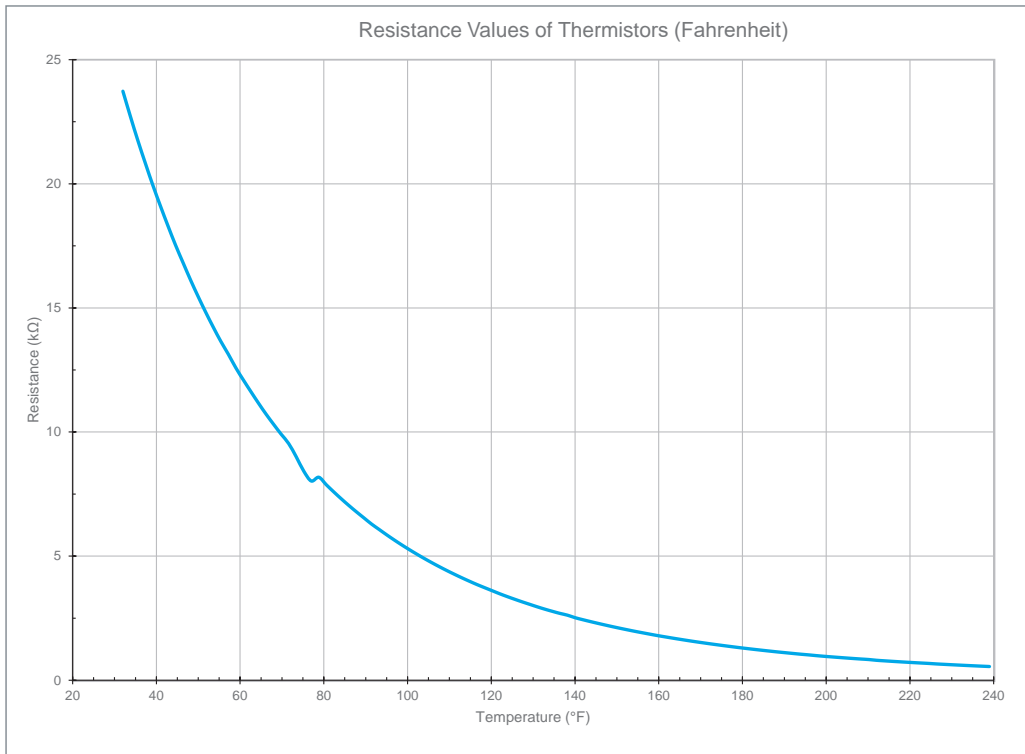

Figure 219 - Thermistor value diagram (Fahrenheit)

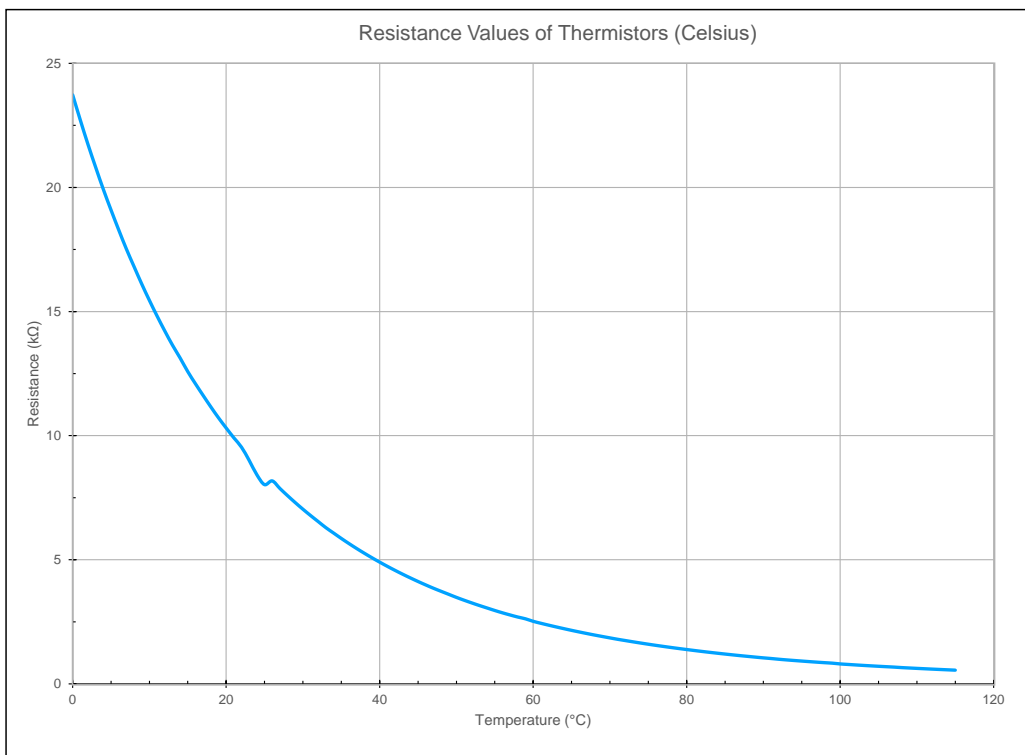

Figure 220 - Thermistor value diagram (Celsius)



Copyright © 2025, A.O. Smith.
All Rights Reserved

