

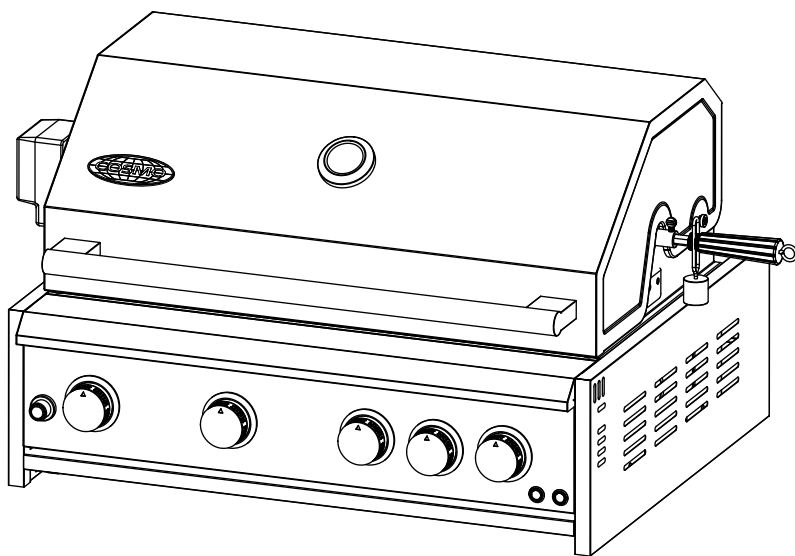

# GAS GRILL

## COS-BGGN325K



# OUTDOOR BUILT-IN GRILL

## USER MANUAL

**IMPORTANT:** READ AND SAVE THESE INSTRUCTIONS.  
FOR RESIDENTIAL USE ONLY.

**INSTALLER:** PLEASE LEAVE THESE INSTRUCTIONS WITH THIS UNIT FOR  
THE OWNER.

**OWNER:** PLEASE RETAIN THESE INSTRUCTIONS FOR FUTURE  
REFERENCE.

Rev.24.05

# THANK YOU FOR YOUR PURCHASE

**Thank you for your purchase. We know that you have many brands and products to choose from and we are honored to know that you have decided to take one of our products into your home and hope that you enjoy it.**

COSMO Appliances are designed according to the strictest safety and performance standard for the North American market. We follow the most advanced manufacturing philosophy. Each appliance leaves the factory after thorough quality inspection and testing. Our distributors and our service partners are ready to answer any questions you may have regarding how to install, use and care for your products. We hope that this manual will help you learn to use the product in the safest and most effective manner.

**Before using this product, please read through this manual carefully.** Keep this user manual in a safe place for future reference. Please ensure that other persons using this product are familiar with these instructions as well.

If you have any questions or concerns, please contact the dealer from whom you purchased the product, or contact our Customer Support at:

**1-888-784-3108**

Reach us online at:

**[www.cosmoappliances.com](http://www.cosmoappliances.com)**

# TABLE OF CONTENTS

<b>GRILL SAFETY</b> .....	<b>4</b>
Important Safety Instructions .....	6
<b>INSTALLATION REQUIREMENTS</b> .....	<b>8</b>
Tools and Parts .....	8
Location Requirements .....	9
<b>PRODUCTION DIMENSIONS</b> .....	<b>10</b>
Grill Layout .....	10
Internal Dimensions .....	11
<b>LP GAS CONNECTION</b> .....	<b>12</b>
Gas Pressure Regulator .....	12
Install Propane Tank .....	13
<b>ELECTRICAL SAFETY</b> .....	<b>14</b>
<b>GRILL INSTRUCTIONS</b> .....	<b>15</b>
Control Panel .....	15
Rotisserie Chart .....	19
Tips for Outdoor Grilling .....	20
Cooking Methods .....	21
<b>COOKING RECIPES</b> .....	<b>22</b>
Grilling Chart .....	22
<b>OUTDOOR GRILL CARE</b> .....	<b>25</b>
<b>TROUBLESHOOTING</b> .....	<b>29</b>
<b>WARRANTY AND SERVICE</b> .....	<b>31</b>

# GRILL SAFETY

## READ ALL INSTRUCTIONS BEFORE USING THE APPLIANCE

### Your safety and the safety of others are very important.

We have provided many important safety messages in this manual and on your appliance. Always read and obey all safety messages.



This is the safety alert symbol.

This symbol alerts you to potential hazards that can kill or hurt you and others.

All safety messages will follow the safety alert symbol and either the word "WARNING" or "CAUTION." These words mean:



You can be killed or seriously injured if you don't follow instructions.



A potentially hazardous situation which, if not avoided, could result in minor or moderate injury.

All safety messages will tell you what the potential hazard is, tell you how to reduce the chance of injury, and tell you what can happen if the instructions are not followed.

## **WARNING**

1. Use outdoors only
2. Read the instructions before using the appliance.
3. Warning: accessible parts may be very hot. Keep young children away.
4. This appliance must be kept away from flammable materials during use.
5. Do not move the appliance during use.
6. Turn off the gas supply at the gas container after use.
7. Do not modify the appliance.

## DANGER



### FIRE AND EXPLOSION HAZARD

If the information in this manual is not followed exactly, a fire or explosion may result causing property damage, personal injury or death.

- Do not store or use gasoline or other flammable vapors and liquids in the vicinity of this or any other appliance.
- Gas not connected for use shall not be stored in the vicinity of this or any other appliance.
- WHAT TO DO IF YOU SMELL GAS
  - Shut off gas to the appliance.
  - Extinguish any open flame.
  - Open the lid.
  - If odor continues, keep away from the appliance and immediately call your gas supplier or your fire department.
- Securely tighten all gas connections. Have a qualified technician make sure that gas pressure does not exceed rated gas pressure.
- Examples of a qualified technician include:
  - Licensed heating personnel.
  - Authorized gas company personnel, and authorized service personnel.
- Failure to do so can result in explosion, fire hazard or death.

## WARNING

The installation must conform with local codes or, in the absence of local codes, with either the National Fuel Gas Code, ANSI Z223.1/NFPA 54, or the Natural Gas and Propane Installation Code, CSA B149.1, or the Propane Storage and Handling Code, CSA B149.2

The outdoor cooking gas appliance, when installed, must be electrically grounded in accordance with local codes or, in the absence of local codes, with the National Electrical Code, ANSI/NFPA 70, or the Canadian Electrical Code, Part I, CSA C22.1.

# IMPORTANT SAFETY INSTRUCTIONS

**WARNING:** To reduce the risk of fire, electrical shock, injury to persons, or damage when using the grill, follow basic precautions, including the following:

- An outdoor cooking gas appliance is not intended to be installed in or on boats.
- Always maintain minimum clearances from combustible construction, see "Location Requirements" section.
- The outdoor cooking gas appliance shall not be located under overhead unprotected combustible construction.
- This outdoor cooking gas appliance shall be used only outdoors and shall not be used in a building, garage, or any other enclosed area.
- Keep any electrical supply cord and fuel supply hose away from any heated surfaces.
- Keep outdoor cooking gas appliance area clear and free from combustible materials, gasoline and other flammable vapors and liquids.
- Do not obstruct the flow of combustion and ventilation air. Keep the ventilation openings of the cylinder enclosure free and clear from debris.
- Inspect the gas cylinder supply hose before each use of the outdoor cooking gas appliance. If the hose shows excessive abrasion or wear, or is cut, it **MUST** be replaced before using the outdoor cooking gas appliance. Contact your dealer and use only replacement hoses specified for use with the outdoor cooking gas appliance. The replacement hose assembly shall be that specified by the manufacturer.
- Visually check the burner flames. They should be blue or slightly yellow.
- Check and clean burner / venturi tube for insects and insect nest. A clogged tube can lead to fire under the outdoor cooking gas appliance.



# IMPORTANT SAFETY INSTRUCTIONS

- This model is designed for use with a Standard 20 lb. Liquid Petroleum Gas tank. A 20lb tank of approximately 305mm in diameter by 393mm high, provided with a listed overfilling prevention device and a cylinder connection device compatible with the connection for outdoor cooking gas appliances.
- Always check connections for leaks each time you connect the gas supply cylinder. See "Installation Instructions" section.
- When the outdoor cooking gas appliance is not in use, the gas must be turned off at the supply cylinder.
- Storage of an outdoor cooking gas appliance indoors is permissible only if the cylinder is disconnected and removed from the outdoor cooking gas appliance.
- Cylinders must be stored outdoors and out of the reach of children and must not be stored in a building, garage or any other enclosed area. The pressure regular and hose assembly supplied with the outdoor cooking gas appliance must be used. A replacement gas regulator & hose assembly must comply with the manufacturer.
- Place a dust cap on cylinder valve outlet whenever the cylinder is not in use. Only install the type of dust cap on the cylinder valve outlet that is provided with the cylinder valve. Other types of caps or plugs may result in leakage of gas.
- If the following information is not followed exactly, a fire causing death or serious injury may occur.
- Do not store a spare gas cylinder under or near this outdoor cooking appliance.
- Never fill the cylinder beyond 80 percent full.
- The LP gas cylinder to be used must be constructed and marked in accordance with the Specifications for LP Gas Cylinders of the U.S. Department of Transportation (D.O.T.) or the Standard for Cylinders, Spheres and Tubes for Transportation of Dangerous Goods and Commission, CAN/CSA-B339.
- The cylinder used must include a collar to protect the cylinder valve.
- If the information above is not followed exactly, a fire causing death or serious injury may occur.

**READ AND SAVE THESE INSTRUCTIONS**

# INSTALLATION REQUIREMENTS

## TOOLS AND PARTS

Gather the required tools and parts before starting installation. Read and follow the instructions provided with any tools listed here.

### TOOLS NEEDED

- Tape measure
- Phillips screwdriver
- Level
- Adjustable wrench or pliers
- Safety glasses
- Gloves

### For Propane/Natural Gas Conversions

- Combination wrench
- Nut drive

### PARTS NEEDED

- 1 - AA alkaline battery  
(for burner ignition)
- Propane tank

### PARTS SUPPLIED

- Gas pressure regulator /  
Hose assembly
- Rotisserie kit & hardware

# LOCATION REQUIREMENTS

Select a location that provides minimum exposure to wind and traffic paths. The location should be away from strong draft areas.

Do not obstruct flow of combustion and ventilation air.

Clearance to combustible construction for outdoor grills:

- A minimum of 36" (91.44 cm) must be maintained between the front of the grill hood, sides and back of the grill and any combustible construction.
- A 36" (91.44 cm) minimum clearance must also be maintained below the cooking surface and any combustible construction.

See "Warranty and Service" section to order.

## **WARNING**



### **FIRE AND EXPLOSION HAZARD**

- Do not store fuel tank in a garage or indoors.
- Do not store grill with fuel tank in a garage or indoors.
- Failure to follow these instructions can result in death, explosion or fire.
- Do not use grill near combustible materials.
- Do not store combustible materials near grill.
- Doing so can result in death or fire.

# PRODUCT DIMENSIONS

## GRILL LAYOUT

The locations and appearances of the features shown here may not match those of your model.

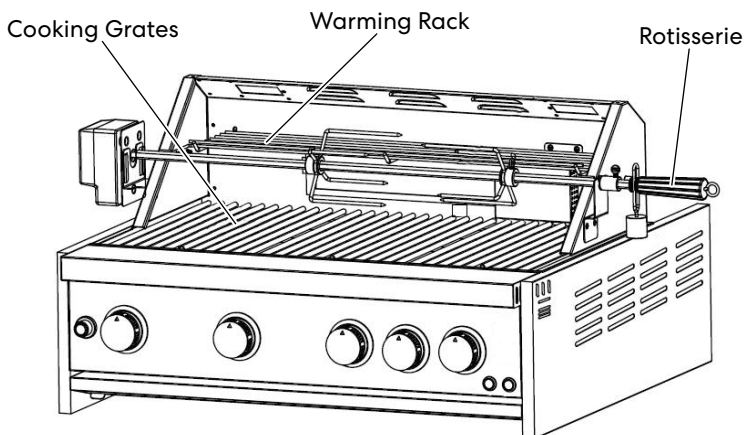
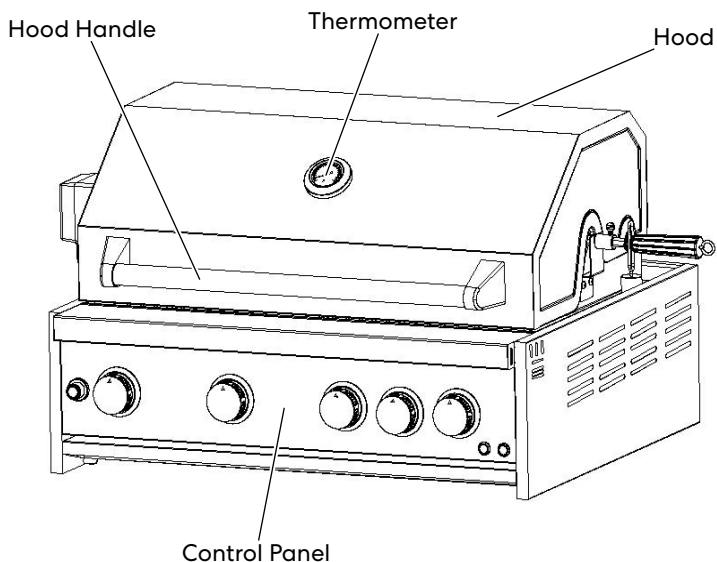

# INTERNAL DIMENSIONS

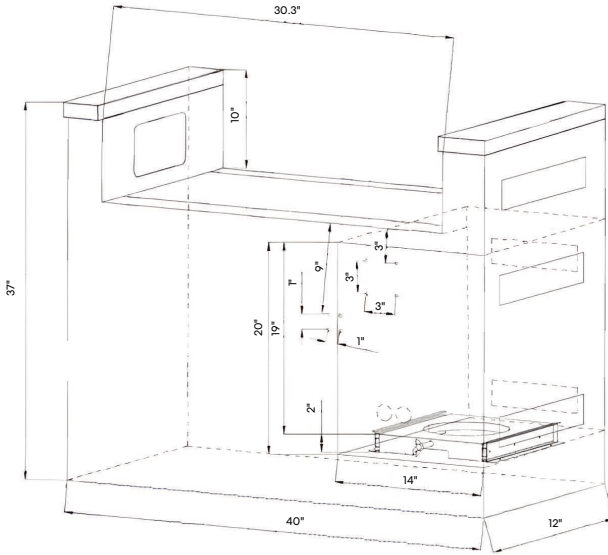

Open heat emission space on either side of top cabinet should be at least 20in<sup>2</sup>

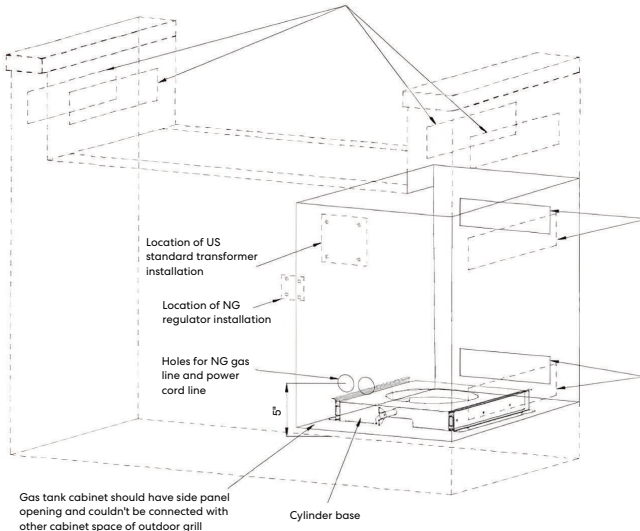

At least 2 ventilation openings are needed and distance between opening to the top cabinet countertop should be no more than 5". Minimum degree for ventilation opening is 90 degrees. The total space should be at least 1 in<sup>2</sup>/lb (20 in<sup>2</sup> for normal LP tank).

At least 2 ventilation openings are needed and distance between opening to the bottom plate should be no more than 5". Minimum degree for ventilation opening is 90 degrees. The total space should be at least 1 in<sup>2</sup>/lb (20 in<sup>2</sup> for normal LP tank).

# LP GAS CONNECTION

## GAS PRESSURE REGULATOR

The gas pressure regulator supplied with this grill must be used.

The inlet (supplied) pressure to the regulator should be as follows for proper operation.

### Connect Regulator with Hose to Your LP Gas Tank

- Turn all control knobs to the OFF position.
- Inspect the valve connection port and regulator assembly for damage or debris. Remove any debris. Never use damaged equipment.
- Connect the regulator assembly to the tank valve and hand tighten nut clockwise to a full stop. **DO NOT** use a wrench to tighten because it could damage the quick coupling nut and result in a gas leak/fire hazard.
- Open the tank valve 1/4 to 1/2 of a full turn (counterclockwise) and use a soapy water solution to check all connections for leaks before attempting to light your grill. See "Check All Connections for LP Gas Leaks". If a leak is found, turn the tank valve off and do not use your grill until the leak is repaired.

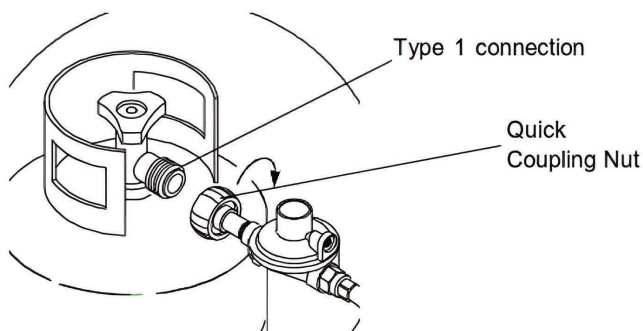

## INSTALL PROPANE TANK

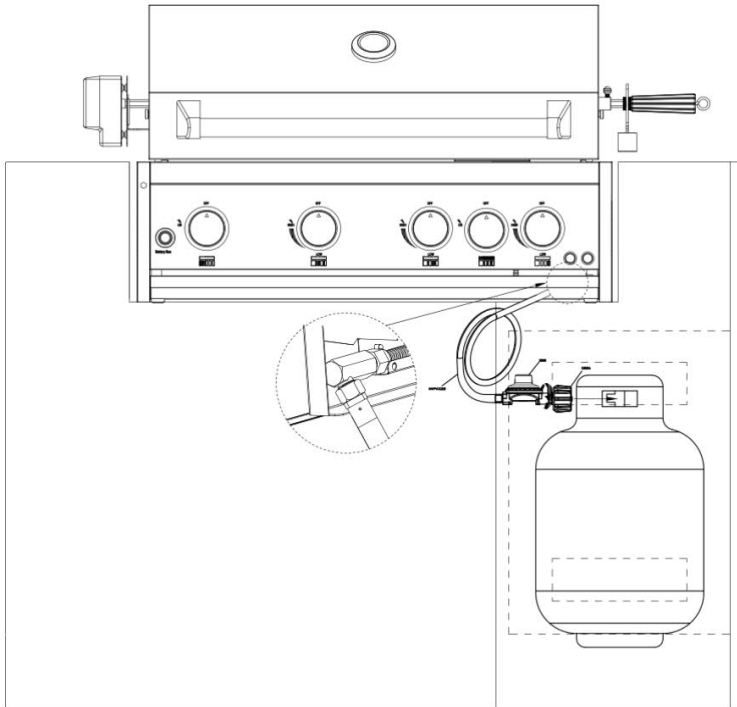

### LP Tank Installation Layout

1. This grill is designed to operate with a propane tank (not supplied). A gas pressure regulator / hose assembly is supplied.
2. Grill tank tray is compatible with most of the propane tanks in the market. The propane tank must be mounted and secured.
3. Open cabinet doors.
4. Loosen the tank tray locking screw.
5. Put propane tank into the tank tray under the grill.
6. Tighten the locking screw clockwise against the bottom collar of the propane tank to secure the tank (see image above)
7. For easy installation, the tank liquid withdrawal valve is suggested to face the right side.

# ELECTRICAL SAFETY

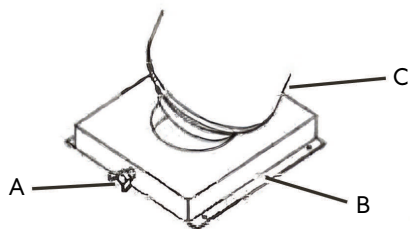

- A. Locking screw
- B. Tank tray
- C. 20 lb LP gas fuel tank tray

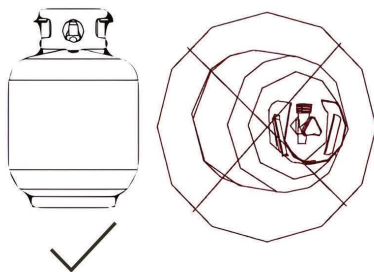

Cylinder must be arranged to provide vapor withdraw

Electrical equipment provided with the outdoor cooking gas appliance shall have the following in the instructions:

- To protect against electric shock, do not immerse cord or plugs in water or other liquid.
- Unplug from the outlet when not in use and before cleaning. Allow to cool before putting on or taking off parts.
- Do not operate any outdoor cooking gas appliance with a damaged cord, plug, or after the appliance malfunctions or has been damaged in any manner. Contact the manufacturer for repair.
- Do not let the cord hang over the edge of a table or touch hot surfaces.
- Do not use an outdoor cooking gas appliance for purposes other than intended.
- When connecting, first connect plug to the outdoor cooking gas appliance then plug appliance into the outlet.
- Use only a Ground Fault Interrupter (GFI) protected circuit with this outdoor cooking gas appliance.
- Never remove the grounding plug or use with an adapter of 2 prongs.
- Use only extension cords with a 3-prong grounding plug, rated for the power of the equipment, and approved for outdoor use with a W-A marking.

# GRILL INSTRUCTIONS

The grill you have purchased may have some or all the feature listed below. The locations and appearances of the features shown here may not match what you are having on your model.

## CONTROL PANEL

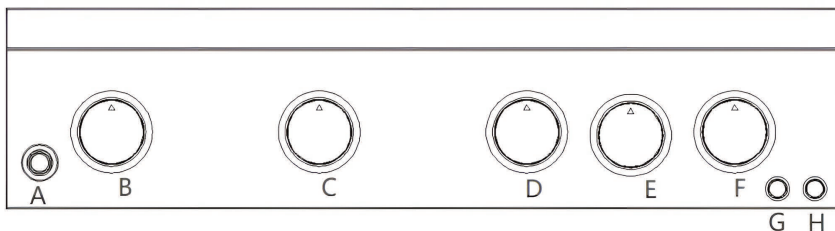

- |   |   |
|---|---|
| <b>A.</b> Battery Box (for ignition)    | <b>E.</b> Back Broil Burner Knob<br>(Rotisserie Burner) |
| <b>B.</b> Front Left Broil Burner Knob  | <b>F.</b> Front Right Tube Burner Knob                  |
| <b>C.</b> Front Left Tube Burner Knob   | <b>G.</b> Grill Knob Light Switch                       |
| <b>D.</b> Front Middle Tube Burner Knob | <b>H.</b> Grill Cavity Light Switch                     |

## WARNING



### FIRE AND EXPLOSION HAZARD

- Do not store fuel tank in a garage or indoors.
- Do not store grill with fuel tank in a garage or indoors.
- Failure to follow these instructions can result in death, explosion or fire.
- Do not use grill near combustible materials.
- Do not store combustible materials near grill.
- Doing so can result in death or fire.

## **WARNING**

### **FOOD POISONING HAZARD**

- Do not let food sit for more than one hour before or after cooking.
- Doing so can result in food poisoning or sickness.

### **Inspect the Gas Fuel Tank Supply Hose**

Inspect the gas pressure regulator/hose assembly before each use.

If it is evident there is excessive abrasion or wear, or the hose is cut, it must be replaced prior to the outdoor cooking gas appliance being put into operation. The replacement hose assembly shall be that specified by the manufacturer.

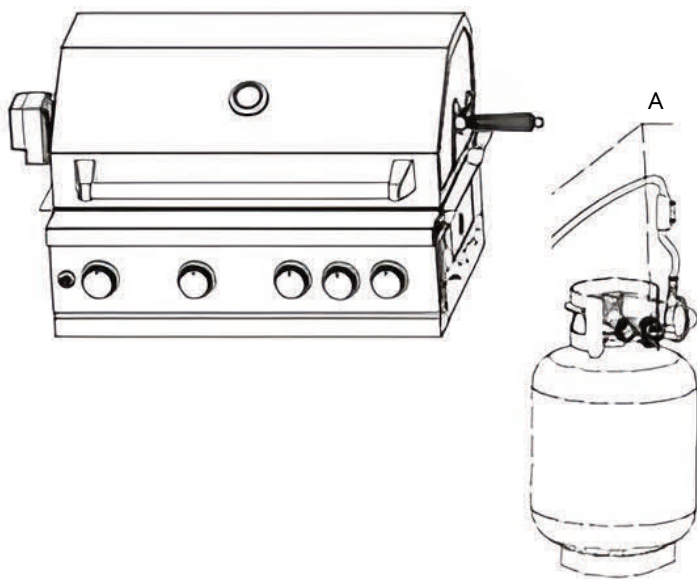

A. Gas pressure regulator/hose assembly

## Prepare the Gas Supply

1. Make sure control knobs are turned to OFF. The drip tray must be in place and pushed all the way to the back.

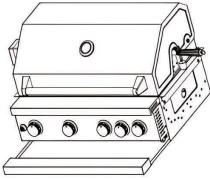

## Turn the Gas Supply On

1. For outdoor grills using a propane tank. Slowly open the tank valve.

**NOTE:** If flow limiting device activates, your grill may not light. If your grill does light, the flames will be low and will not heat properly. Turn tank valve and all control knobs off and wait 30 seconds. After shutting off the tank, very slowly open tank valve and wait 5 seconds before lighting.

2. For outdoor grills using natural gas supply source (if applicable). Open the manual shutoff valve in the gas supply line. The valve is open when the handle is parallel to the gas pipe.

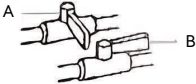

A. Closed valve  
B. Open valve

## Turn the Gas Supply On

**IMPORTANT:** If burner does not light immediately, turn the burner knob to OFF and wait 5 minutes before relighting.

1. Do not lean over the grill.  
2. Select the burner you want to light. Push the pulse igniter module and push in and turn the grill burner control knob to IGNITE/HI, while continuing to hold it in.

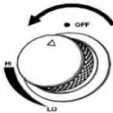

3. You will hear the "snapping" sound of the spark. When burner is lit, release the knob. Turn knob to desired setting.  
4. Repeat for each of the other burners as needed.

## Manually Lighting the Main Grill

1. Do not lean over the grill.  
2. Remove the manual lighting extension (see following illustration) and attach a match to the split ring.

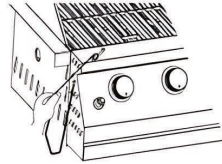

3. Strike the match to light it.  
4. Guide the lit match under the grill grate.

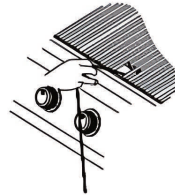

5. Push the pulse igniter module, push in and turn the burner knob to IGNITE/HI for the burner closest to the lit match. The burner will light immediately. When burner is lit turn knob to desired setting.

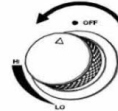

6. Repeat steps 2 through 5 for each main burner.  
7. Remove match and replace manual lighting extension on the right side panel.

### **IMPORTANT:**

If the burner does not light immediately, turn the burner knob to OFF and wait 5 minutes before relighting.

If any burners do not light after attempting to light them manually. Contact the Customer Service Center. See the "Warranty and Service" section.

### **WARNING** (after use):

Storage of an outdoor cooking gas appliance indoors is permissible only if the cylinder is disconnected and removed from the outdoor cooking gas appliance.

## Using Your Rotisserie Burner

To avoid damage to the warming rack, remove from grill when using the rotisserie burner.

Do not use the main burners when the rotisserie burner is in use.

### Lighting the Rotisserie Burner

1. Do not lean over the grill.
2. Push the pulse igniter module. Push and turn rear burner knob slowly to IGNITE/Hi. You will hear the "snapping" sound of the spark.



3. When the rotisserie burner lights, continue to hold the knob in for another 15 seconds, then release the knob and burner will stay lit. You will hear the "snapping" sound of the spark until the knob is released.

**IMPORTANT:** If the rotisserie burner does not light immediately, turn the burner knob to OFF and wait 5 minutes before relighting.

4. Please note that rotisserie burner has a high setting only.

### Manually Lighting the Rotisserie Burner

1. Do not lean over the grill.
2. Remove the manual lighting extension (see following illustration) and attach a match to the split ring.

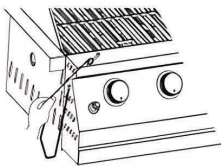

3. Strike the match to light it.
4. Gently hold the lit match close to the rotisserie burner.

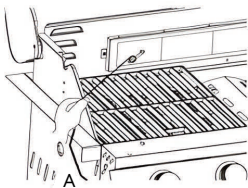

A. Lighting Extension

5. Push the pulse igniter module and push in and turn the control knob IGNITE/ON. Hold this knob in for 15 seconds after the burner is lit. You will hear the "snapping" sound of the spark until after the knob is released.



**IMPORTANT:** If the rotisserie burner does not light immediately, turn the rotisserie burner control knob to OFF and wait 5 minutes before relighting.

6. Remove the match and replace the manual lighting extension inside the cabinet door.

## ! WARNING

- Do not let food sit for more than one hour before or after cooking.
- Doing so can result in food poisoning or sickness.
- It's suggested to use protective gloves when handling particularly hot components.
- Parts sealed by the manufacturer must not be altered or changed by end user.

## ROTISSERIE CHART

Use a portable meat thermometer to check internal doneness of the food.

Turn off rotisserie burner when meat thermometer reads 5°F/3°C lower than desired internal temperature. Continue rotating, hood closed, for 10 minutes before carving.

Timing is affected by weather conditions such as wind and outside temperature.

FOOD ITEM	WEIGHT	INTERNAL DONENESS OR TEMPERATURE (°F/°C)	APPROX. GRILLING TIME (MIN/LB)
<b>Beef</b> Roasts Rib Eye Sirloin Tip Rib, boneless	4-6 lbs (1.5-2.2 kg)	Medium-rare (145°F / 63° C)	15-20
		Medium (160°F / 71° C)	20-25
<b>Poultry</b>  Chicken   Turkey, whole	3-6 lbs (1.1-2.2 kg)	Breast (170°F / 77°C)	25-30
		Thigh (180°F / 82°C)	25-30
	7-10 lbs (2.6-3.7 kg)	Breast (170°F / 77°C)	11-20
		Thigh (180°F / 82°C)	11-20
<b>Lamb</b> Boneless leg	4-7 lbs (1.5-2.6 kg)	Medium (160°F / 71°C)	20-25
<b>Pork</b> Loin roast, boneless	4-6 lbs (1.5-2.2 kg)	Medium (160°F / 71°C)	20-23

## TIPS FOR OUTDOOR GRILLING

### **WARNING**

#### **FOOD POISONING HAZARD**

- Do not let food sit for more than one hour before or after cooking.
- Doing so can result in food poisoning or sickness.

### **BEFORE GRILLING**

- Thaw food items before grilling.
- Preheat grill on high (use all grill burners) 10 minutes. The hood must be closed during preheating. Preheating provides the high heat needed to brown food and seal juices.
- Shorten the preheat time when grilling high-fat cuts of meat or poultry, such as chicken thighs. This will help reduce flare-ups.
- Lightly oil the grill grates or the food when cooking low-fat cuts of meat, fish or poultry, such as lean hamburger patties, shrimp or skinless chicken breasts.
- Using too much oil can cause gray ash to deposit on food.
- Trim excess fat from meats prior to cooking to reduce flare-ups.
- Make vertical cuts at 2" (5.0 cm) intervals around the fat edge of meat to avoid curling.
- Add seasoning or salt only after the cooking is finished.

### **DURING GRILLING**

- Turn foods only once. Juices are lost when meat is turned several times.
- Turn meat just when juices begin to appear on the surface.
- Avoid puncturing or cutting the meats to test doneness. This allows juices to escape.
- It may be necessary to lower the heat settings for foods that cook a long time or are marinated or basted in a sugary sauce.
- If using a high flame, add barbecue sauce only during the last 10 minutes of cooking to avoid burning the sauce.
- The degree of doneness is influenced by the type of meat, cut of meat (size, shape and thickness), heat setting selected and length of time on the grill.
- Cooking time will be longer with an open grill cover.

# COOKING METHODS

## DIRECT HEAT

Cooking by direct heat means the food is placed on grill grates directly above lighted burners. Hood position can be up or down. If hood is in the up position, total cooking times may be longer. Direct heat sears the food. Searing is a process that seals natural juices in food by cooking with intense heat for a short period of time. While juices stay inside, the outside is browned with a flavorful grilled coating.

## INDIRECT HEAT

For best results, do not select the indirect heat cooking method when it is windy. Cooking by indirect heat means the food is placed on the grill grate above an unheated burner, allowing heat from lighted burner(s) on either side to cook the food.

If possible turn on 2 burners. Cook with the hood down. This will shorten the cooking time.

# COOKING RECIPES

## GRILLING CHART

- Knobs have High, Medium and Low settings for flame adjustment.
- Heat settings indicated are approximate.
- Grilling times are affected by weather conditions.
- When 2 temperatures are listed, for example: Medium to Medium-Low, start with the first and adjust based on cooking progress.
- Cooking times may vary from chart times depending on the type of fuel, Natural or LP gas.

FOOD	COOKING METHOD/ BURNER SETTING	INTERNAL FOOD TEMP. °F (°C)	TIME (TOTAL MINUTES)	SPECIAL INSTRUCTIONS
<b>Beef</b>				
<b>Hamburgers</b> , 1/2" to 3/4" thick	DIRECT Medium	Medium (160°F/71°C)	10-15	Grill, turning once
<b>Roasts</b> Rib Eye, Sirloin	INDIRECT Med/OFF/ Med	Med-Rare (145°F/63°C) to Medium (160°F/71°C)	32-40 per lb	Tent with foil first 45-60 minutes of cooking time.
<b>Steaks</b> , 1" Porterhouse, Rib, T-bone, Top Loin, Sirloin	DIRECT Medium	Med-Rare (145°F/63°C) to Medium (160°F/71°C)	11-16	Rotate steaks 1/4 turn to create criss-cross grill marks.
<b>Steaks</b> , 1 1/2" Porterhouse, Rib, T-bone, Top Loin, Sirloin	DIRECT Medium	Med-Rare (145°F/63°C) to Medium (160°F/71°C)	18-25	
<b>Top or Shoulder / Chuck</b> (London Broil) 1 1/2" thick	DIRECT Medium	Med-Rare (145°F/63°C) to Medium (160°F/71°C)	22-29	
<b>Flank</b> , 1/2" thick	DIRECT Medium	Med-Rare (145°F/63°C)	11-16	
<b>Pork</b>				
<b>Chops</b> , 1" 1 1/2" thick	DIRECT Medium to Med-Low	Medium (160°F/71°C)	12-22  30-40	
<b>Ribs</b> , 2 1/2-4 lbs	INDIRECT Med/OFF/ Med	Medium (160°F/71°C)	40-60	Grill, turning occasionally. During last few minutes brush with barbecue sauce if desired. When done, wrap in foil.
<b>Roast</b> , boneless tenderloin, 1 lb	DIRECT Medium	Medium (160°F/71°C)	18-22	Turn during cooking to brown on all sides.
<b>Ham half</b> , 8-10 lbs	INDIRECT Med/OFF/ Med	Reheat (140°F/60°C)	2-2 1/2 hours	Wrap entire ham in foil and put on grill without pan or drip pan.

FOOD	COOKING METHOD/ BURNER SETTING	INTERNAL FOOD TEMP. °F (°C)	TIME (TOTAL MINUTES)	SPECIAL INSTRUCTIONS
<b>Ham steak precooked,</b> 1/2" thick	DIRECT Preheat Medium Grill Medium	Reheat (145°F/63°C)	7-10	
<b>Hot Dogs</b>	DIRECT Medium	Reheat (145°F/63°C)	5-10	Slit skin if desired.
<b>Chicken</b> <b>Breast,</b> boneless	DIRECT Medium	170°F / 77°C	15-22	For even cooking, pound breast to 3/4" thick.
<b>Pieces,</b> 2-3 lbs	DIRECT Med-Low to Medium	Breast 170°F/77°C Thigh 180°F/82°C		Start bone side down.
<b>Lamb</b> <b>Chops and Steaks Loin,</b> <b>Rib, Sirloin,</b> 1" thick	DIRECT Medium	Med-Rare (145°F/63°C) to Medium (160°F/71°C)	10-20	
1 1/2" thick	DIRECT Medium	Med-Rare (145°F/63°C) to Medium (160°F/71°C)	16-20	
<b>Fish and Seafood</b> <b>Filletts, Steaks, Chunks,</b> <b>Halibut, Salmon</b> <b>Swordfish,</b> 8 oz	DIRECT Medium		4-6 per 1/2" thickness of fish	Grill, turning once. Brush grill with oil to keep fish from sticking. Remove when inside is opaque and flaky with skin easily removed.
<b>Whole, Catfish,</b> <b>Rainbow Trout,</b> 8-11 oz	DIRECT High		5-7 per side	
<b>Shellfish, Scallops, Shrimp</b>	DIRECT Medium		4-8	
<b>Turkey</b> <b>Whole Breast</b> (bone-in)	INDIRECT HI/OFF/HI	170°F / 77°C	14-18 per lb	Tent with foil until last 30 minutes of cooking time.
<b>Half breast</b> (bone-in)	INDIRECT Med/OFF/Med	170°F / 77°C	25-30 per lb	Start skin side down.
<b>Whole,</b> 7-12 lbs	INDIRECT HI/OFF/HI	Breast 170°F / 77°C Thigh 180°F / 82°C	11-16 per lb	Less than 11 lbs.
<b>Fresh Vegetables</b> <b>Corn on the Cob</b>	DIRECT Medium		20-25	Soak in cold water 20 minutes. Do not husk. Shake off excess water.

FOOD	COOKING METHOD/ BURNER SETTING	INTERNAL FOOD TEMP. °F (°C)	TIME (TOTAL MINUTES)	SPECIAL INSTRUCTIONS
<b>Eggplant</b>	DIRECT Medium		7-10	Wash and cut into 1/2" slices or lengthwise. Brush with olive oil.
<b>Onion, 1/2" thick</b>	DIRECT Medium		8-20	Grill, turning once. Brush with olive oil. Put a skewer through several slices to hold together.
<b>Potatoes, Sweet, whole</b>	DIRECT Medium		40-70	Individually wrap in heavy-duty foil. Grill, rotating occasionally.
Baking, whole	DIRECT High		45-90	
<b>Peppers, Roasted</b>	DIRECT High			Wash and place on grill whole. Char skin all around. Cool in a paper bag or plastic wrap to loosen blackened skin. Peel and remove seeds.
<b>Squash, Summer, Zucchini</b>	DIRECT Medium		7-10	Wash and cut into 1/2" slices or lengthwise. Brush with olive oil
<b>Garlic, Roasted</b>	DIRECT Medium		7-10	Cut off top, drizzle with olive oil and wrap in double layer of foil.

# OUTDOOR GRILL CARE

## REPLACING THE IGNITER BATTERY

If igniters stop sparking, the battery should be replaced.

1. Unscrew igniter button cap counterclockwise to remove.

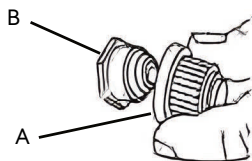

A. Igniter Push Button  
B. "AA" Size Battery

2. Remove battery from the battery compartment.
3. Replace with a new alkaline "AA" size battery. Install battery with negative end in first.
4. Screw igniter button cap clockwise into place.

## GENERAL CLEANING

**IMPORTANT:** Before cleaning, make sure all controls are off and the grill is cool. Always follow label instructions on cleaning products.

For routine cleaning, wash with soap and water using a soft cloth or sponge. Rinse with clean water and dry at once with a soft, lint-free cloth to avoid spots and streaks.

Do not use steel wool to clean the grill, as it will scratch the surface.

To avoid weather damage to finish, use vinyl grill cover. See "Warranty and Service" section to order.

## STAINLESS STEEL

**IMPORTANT:** To avoid damage to stainless steel surfaces, do not use soap-filled scouring pads, abrasive cleaners, cooktop polishing creme, steel wool, gritty wash cloths or paper towels.

Cleaners should not contain chlorine. Damage may occur.

Food spills should be cleaned as soon as entire grill is cool. Spills may cause permanent discoloration.

### Cleaning Method:

- Stainless steel cleaner: Rub in direction of grain to avoid scratching or damaging the surface.
- Liquid detergent or all-purpose cleaner: Rinse with clean water and dry with soft, lint-free cloth
- Vinegar to remove hard water spots
- Glass cleaner to remove fingerprints

## GRILL GRATES

**IMPORTANT:** To avoid damage to grill grates, do not use a steel or fiber scraper. Immediately after you are finished cooking, loosen food soil with a brass bristle brush. Turn all burners to HI for 10-15 minutes with the hood closed to burn off food soil. Turn off all burners, raise the hood and let grates cool. Use the brass bristle brush to remove ash from the grill grates.

When completely cool, grill racks can be removed for thorough cleaning. Clean them with a mild detergent and warm water.

For baked-on soil, prepare a solution of 1 cup (250 ml) ammonia for 1 gal. (3.75 L) water. Soak grates for 20 minutes, then rinse with water and dry completely.

## WARMING RACK

### Cleaning Method:

- Liquid detergent or an all-purpose cleaner
- Rinse with clean water and dry with soft, lint-free cloth
- For tough spots or baked-on grease, use a commercial degreaser designed for stainless steel

**IMPORTANT:** Make sure gas supply is off and all control knobs are in the OFF position.

## EXTERIOR

The quality of this material resists most stains and pitting, providing that the surface is kept clean, polished and covered.

- Apply stainless steel polish to all non-cooking areas before first use. Reapply after each cleaning to avoid permanent damage to surface.

## INTERIOR

Discoloration of stainless steel on these parts is to be expected, due to intense heat from the burners. Always rub in the direction of the grain. Cleaning should always be followed by rinsing with clean, warm water.

### Cleaning Method:

- Liquid detergent or all-purpose cleaner
- Rinse with clean water and dry completely with a soft, lint-free cloth
- A heavy-duty scrub sponge can be used with mild cleaning products
- For small, difficult-to-clean areas, use a commercial degreaser designed for stainless steel

## BURNERS

### Cleaning Method:

- Clean the exterior of the burner with a wire brush
  - Clean any clogged burner ports with a straightened paper clip
  - Do not use a toothpick as it may break off and clog the port
  - Check and clean burner/venturi tubes
1. Remove grill grates and flame tamers
  2. Remove the 2 screws that hold the burner in place. Remove gas burner from the grill.

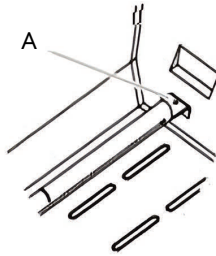

A. 2 screws

3. use a flashlight to inspect into the burner through the burner inlet to ensure there is no blockage. If any obstruction is seen, use a metal coat hanger that has been straightened to clear them.
4. After inspecting the inside of burner for blockage, reassemble burner by sliding the middle tube of the gas burner over the gas orifice.

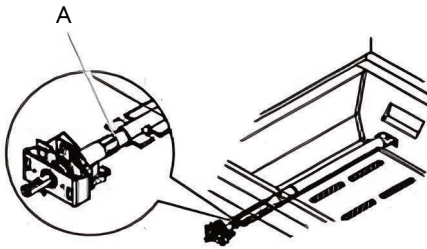

A. Burner/orifice connection

5. Reattach gas burner using 2 screws.

## ROTISSERIE BURNER

### Cleaning Method:

- Light the rotisserie burner. See the "Using Your Rotisserie Burner" section
- Close the grill hood
- Leave the burner on high for approximately 30 minutes
- Turn knob to OFF and let cool completely
- Brush off ash particles from the rotisserie burner

## DRIP TRAY

**IMPORTANT:** The drip tray should only be removed when grill is completely cool

The full-width drip tray collects grease and food particles that fall through the grill. Clean often to avoid grease buildup.

### Cleaning Method:

- Remove tray and set on a flat surface
- Wipe excess grease with paper towels
- Mild detergent and warm water. Rinse and dry thoroughly
- Replace tray

## KNOBS AND FLANGE AREA AROUND KNOBS

**IMPORTANT:** To avoid damage to knobs or flange area around knobs, do not use steel wool, abrasive cleaners, or oven cleaner.

Do not soak knobs.

### Cleaning Method:

- Mild detergent, a soft cloth and warm water
- Rinse and dry

## CONTROL PANEL GRAPHICS

**IMPORTANT:** To avoid damage to control panel graphics, do not use steel wool, abrasive cleaners, or oven cleaner.

Do not spray cleaner directly onto panel.

### Cleaning Method:

- Clean around the burner labels gently; scrubbing may remove printing
- Mild detergent, soft cloth and warm water
- Rinse and dry

# TROUBLESHOOTING

## GRILL WILL NOT LIGHT

- **Is the propane tank valve turned off?**

Turn on the valve.

- **Is the grill properly connected to the gas supply?**

Check installation instructions. For further inquiries, please contact Cosmo Support at 888-784-3108.

- **Is there any gas in propane tank?**

Check the gas level before using the grill.

- **Is the igniter working?**

Check if the igniter battery is properly installed, also check if the battery needs to be replaced.

Check if the grill will light by match.

Check if there's any debris blocking the electrode.

- **If the igniter is not sparking at the tip of the electrode, you might need to replace the igniter.**

## BURNER FLAME WILL NOT STAY LIT

- **Is gas supply valve turned on at the correct position?**

Check the position of the gas valve, adjust the gas valve according to the flame performance.

- **Is gas supply in the fuel gas tank low?**

Check the gas level.

- **Is the burner properly installed and in good condition?**

Check that the burner is installed properly.

Check for defects in the burner.

## FLAME IS NOISY, LOW OR ERRATIC

- **Is the gas supply fully turned on?**

Check if the propane tank valve is fully open.

- **Is the gas supply in the propane tank low?**

Check the gas level

- **Does only one burner appear low?**

Check and clean the burner if it's clogged or dirty. See "General Cleaning" section.

- **Is the gas supply hose bent or kinked?**

Straighten the gas supply hose.

- **Is the flame noisy or lifting away from the burner?**

Burner may be getting too much air. Check the air shutter adjustment.

- **Is the burner flame mostly yellow or orange?**

Grill may be in an area that is too windy, or not receiving enough air. Check the burner air inlets for obstructions. Check the air shutter adjustment, see "Check and Adjust Burners" section.

## **EXCESSIVE FLARE-UPS**

- **Is there excessive fat in the food being grilled?**

Keep flame on low or turn one burner off. Keep the hood up when grilling to avoid excessive flare-ups. Move food to the warming rack until flames subside. To avoid damage to the grill, do not spray water on gas flames.

## **LOW HEAT LP GAS**

For outdoor grills using a propane tank, slowly open the tank valve.

**NOTE:** If flow limiting device activates, your grill may not light. If your grill does light, the flames will be low and will not heat properly.

1. Turn tank valve and all control knobs off and wait 30 seconds.
2. After shutting off the tank, slowly open the tank valve and wait 5 seconds before lighting.
3. Light one burner at a time. See "Lighting the Main Grill" section.

## **REPLACING LIGHT BULB**

- Take out the grease tray and find the connector of grill light bulb.
- Take out the 5 screws on the lamp cover to get access to the bulb.



# LIMITED WARRANTY

## WARRANTY AND SERVICE

TO RECEIVE WARRANTY SERVICE, YOUR PRODUCT MUST BE REGISTERED.

TO REGISTER AND REVIEW FULL WARRANTY DETAILS, VISIT:

**[WWW.COSMOAPPLIANCES.COM/WARRANTY](http://WWW.COSMOAPPLIANCES.COM/WARRANTY)**

SCAN TO REGISTER



## CUSTOMER SUPPORT

TO CHAT WITH US LIVE FOR ASSISTANCE, VISIT:

**[WWW.COSMOAPPLIANCES.COM/CHAT](http://WWW.COSMOAPPLIANCES.COM/CHAT)**

SCAN TO CHAT



## IMPORTANT

### Do Not Return This Product To The Store

If you have a problem with this product, please contact COSMO Customer Support at

**+1 (888) 784-3108**

DATED PROOF OF PURCHASE, MODEL #, AND SERIAL # REQUIRED FOR WARRANTY SERVICE.

## IMPORTANT

### Ne pas Réexpédier ce Produit au Magasin

Pour tout problème concernant ce produit, veuillez contacter le service des consommateurs Cosmo Customer Support au

**+1 (888) 784-3108**

UNE PREUVE D'ACHAT DATEE EST REQUISE POUR BENEFICIER DE LA GARANTIE.

## IMPORTANTE

### No regrese este producto a la tienda

Si tiene algún problema con este producto, por favor contacte el ayuda al cliente COSMO al

**+1 (888) 784-3108**

(Válido solo en E.U.A.)

NECESITA UNA PRUEBA DE DE COMPRA FECHADA, NÚMERO DE MODELO Y DE SERIE PARA EL SERVICIO DE LA GARANTÍA.



#### Correct disposal of this product:

This marking indicates that this appliance should not be disposed with other household wastes. To prevent possible harm to the environment or human health from uncontrolled waste disposal, recycle it responsibly to promote the sustainable reuse of material resources.



APPLIANCES

Cosmo is constantly making efforts to improve the quality and performance of our products, so we may make changes to our appliances without updating this manual.

Electronic version of this manual is available at:  
[www.cosmoappliances.com](http://www.cosmoappliances.com)