

The design and specifications of this product are subject to change without prior notice as development continues. Consult with the sales agency or manufacturer for details.

PIONEER®

is a registered trademark of Parker Davis HVAC International, Inc.

Parker Davis HVAC International, Inc.
3250 NW 107th Ave, Doral, FL 33172
USA Tel.: (305) 513-4488
Fax: (305) 513-4499
e-mail: info@pd-hvac.com
Website: www.pd-hvac.com

PIONEER®

INFRARED WIRELESS MULTI-FUNCTION
REMOTE CONTROLLER

OWNER'S MANUAL



Read through and understand these instructions thoroughly before attempting to operate your new air conditioning unit using this remote. Be sure to store this manual for future reference.

☰ Table of Contents

Remote Controller Specifications.....	2
Button Layout and Functions.....	3
Handling the Remote Controller.....	4
LCD Screen Icons and Indicators.....	5
Basic Functions.....	6
Advanced Functions.....	13

Note:

- The layout of the buttons on this remote as depicted here is for the standard model. The actual model purchased may vary slightly from these illustrations.
- The signal output sent by this remote controller is processed entirely by the receiving air conditioning system. In the case that any of the functions of the remote are not available for the specific model of the air conditioning unit, those functions will not work.
- Your air conditioning unit's user manual may have additional information regarding the usage of this remote controller.

Remote Controller Specifications

Model Number	RG66B6(B)/BGEFU1
Rated Voltage	3.0V dry batteries (R03/LR03x2)(2xAAA)
Signal Range	8m (25 feet)
Operational Temperature Range	23°F - 140°F

Notice:

This device complies with all relevant national regulations.

- For Canada, this device is compliant with CAN ICES-3(B)/NMB-3(B).
- For the USA, this device is compliant with section 15 of FCC law. Operation is subject to two conditions:
 - (1) This device may not cause harmful interference, and
 - (2) This device must accept any interference received, including interference that may cause undesired operation.

This equipment has been tested and found to comply within the limits for a Class B digital device, pursuant to section 15 of FCC law. These limits are designed to provide reasonable protection against harmful interference in a residential installation. This equipment generates, uses, and can radiate radio frequency energy and, if not installed and used in accordance with these instructions, may cause harmful interference to radio communications. However, there is no guarantee that interference will not occur in a particular installation. If this equipment does cause harmful interference to radio or television reception, which can be determined by turning the equipment off and on again, the user is encouraged to try and correct the interference by using one or more of the following measures:

- Re-orient or relocate the receiving antenna.
- Increase the separation distance between the equipment and receiver.
- Connect the equipment to an outlet on a different circuit from that which the receiver is currently connected.
- Consult the dealer or an experienced radio/TV technician for help.

Changes or modifications not approved by the party responsible for compliance could void the user's authority to operate the equipment.

Button Layout and Functions

Before using your new air conditioner, be sure to familiarize yourself with the remote control. The following is a brief overview of the remote controller itself. For instructions on how to operate your air conditioner, refer to the **BASIC** and **ADVANCED** functions sections of this manual.

Note: HEAT mode is not supported by your appliance if you have purchased a cooling-only version. The HEAT mode option on this controller will not function with cooling-only appliances.

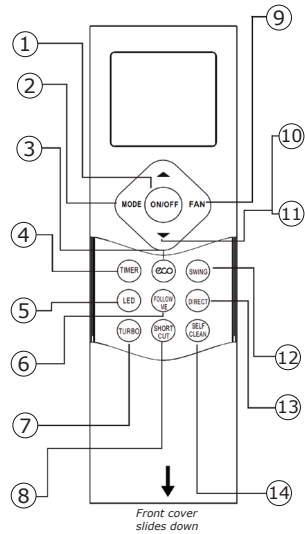

- 1 ON/OFF**
Turns the unit on or off.
- 2 MODE**
Cycles through the following operation modes:
AUTO COOL DRY HEAT FAN
- 3 ECO**
Starts and stops the energy efficiency feature. Hold this button for 2 seconds in order to activate the sleep feature.
- 4 TIMER**
Sets the timer for turning the unit on or off. See the BASIC functions section for instructions.

- 5 LED**
Turns the indoor unit's LED display on or off.
- 6 FOLLOW ME**
Activates the remote as the thermostat instead of the unit.
- 7 TURBO**
Sets the unit to reach the preset temperature in the shortest time.
- 8 SHORTCUT**
Sets/activates your own presets.
- 9 FAN**
Cycles through fan speeds in the following order:
Auto Low Med High
Hold this button for 2 seconds to activate silent mode.
- 10 TEMP ▲**
Raises temp. in 1° increments.
Max 86°F (30°C).
- 11 TEMP ▼**
Lowers temp. in 1° increments.
Min 62°F (17°C).
NOTE: Press and hold ▲▼ together to alternate between °F and °C.
- 12 SWING**
Starts/stops the horizontal louver auto-swing feature.
- 13 DIRECT**
Set the desired up/down air flow direction. (Each press is 6 degrees)
- 14 SELF-CLEAN**
Starts/stops the self-clean feature.

3

Handling the Remote Controller

Not sure what a function does?
Refer to the BASIC FUNCTIONS and ADVANCED FUNCTIONS sections of this manual for detailed descriptions on operating your air conditioner.

Special Note

- The button designs on your unit may differ slightly from the illustrations and examples shown.
- If the indoor unit does not have a particular function, the function selection on the remote will have no effect.

Inserting/Replacing Batteries

- Your air conditioning unit comes with two AAA batteries, which should be inserted into the remote.
- Remove the back cover from the remote to expose the battery compartment.
 - Insert the batteries, paying attention when matching the (+) and (-) ends of the batteries with the symbols in the compartment.
 - Re-attach the back cover.

Installing the Remote Holder

The remote control holder (which may or may not have been included with your unit) can be attached to a wall or stand. Check that the air conditioner is receiving signals before installation. Use the two included screws to install the holder.

! Note About the Battery

- For optimal product performance:
- Do not mix old and new batteries, or ones of different types.
 - Do not leave batteries in a remote that will not be used for more than 2 months.

4

Remote Controller Tips

- The remote controller should be used within 8 meters of the unit.
- The unit will beep when signals from the remote are received.
- Curtains, direct sunlight, etc. can interfere with the receiver's infrared signal.
- If the remote controller will not be used for more than 2 months, be sure to remove its batteries.

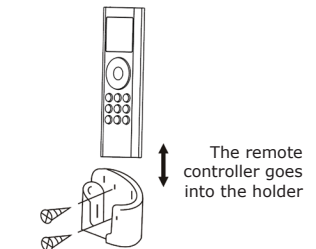
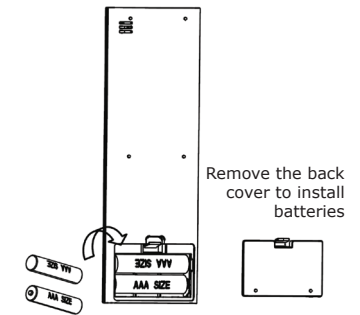

Battery Disposal

Do not dispose of batteries as unsorted municipal waste. Refer to your local laws for the proper disposal of batteries.

LCD Screen Icons/Indicators

Information is displayed when the remote controller powers up. An overview of the various icons is given below.

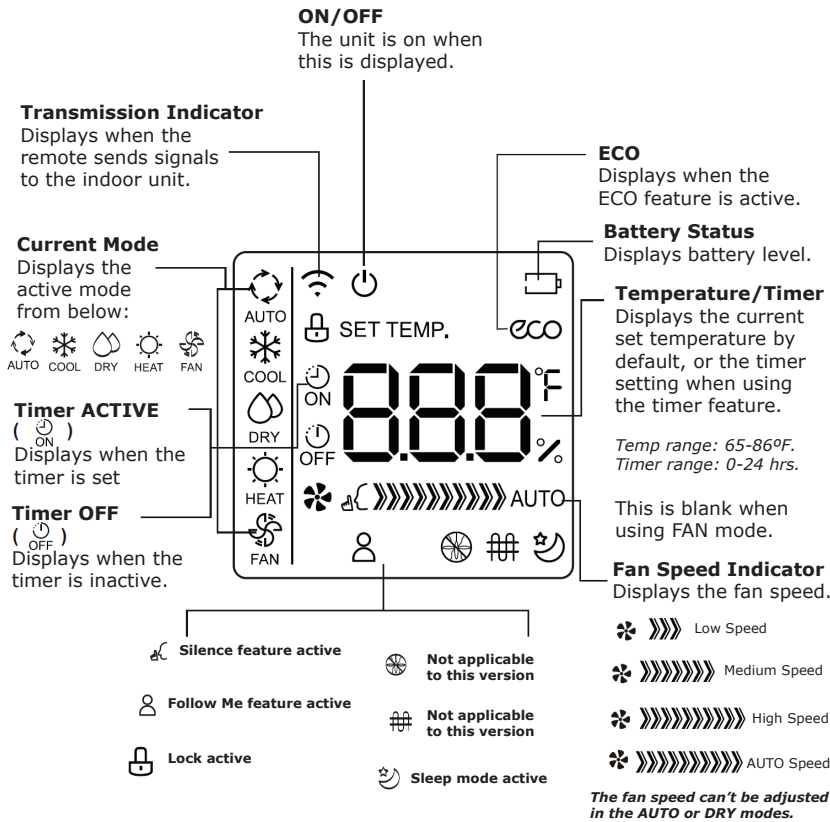

Note: All indicators shown in the figure above are for the purpose of clear presentation. During actual operation, only the relative functional icons will show on the display window.

Basic Functions

AUTO Mode Operation

In AUTO mode, the unit will automatically select COOL, FAN, HEAT, or DRY modes based on the set temperature.

1. Press the MODE button to select AUTO mode.
2. Set your desired temperature using the temp ▲ or temp ▼ buttons.
3. Press the ON/OFF button to start the unit.

Note: Fan speed can't be set when in AUTO mode.

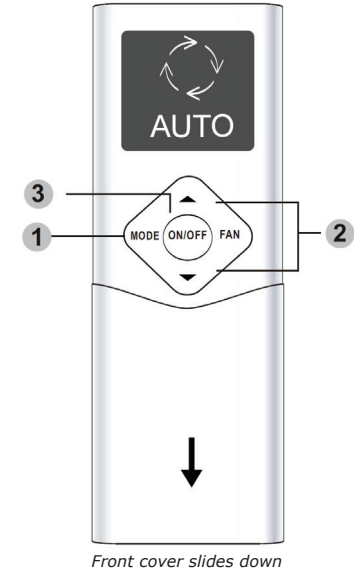

COOL Mode Operation

1. Press the MODE button to select COOL mode.
2. Set your desired temperature using the temp ▲ or temp ▼ buttons.
3. Press the FAN button to select the fan speed.
4. Press the ON/OFF button to start the unit.

Setting Temperatures

The operating temperature range for your air conditioning unit is 62-86°F (17-30°C). You can increase or decrease this set temperature in 1° increments.

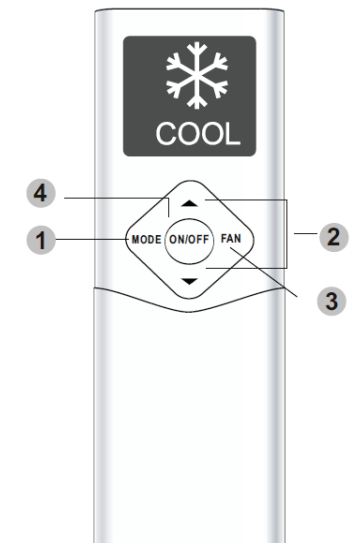

Basic Functions

DRY (Dehumidification) Mode

1. Press the MODE button to select AUTO mode.
2. Set your desired temperature using the temp ▲ or temp ▼ buttons.
3. Press the ON/OFF button to start the unit.

Note: Fan speed can't be set when in DRY mode.

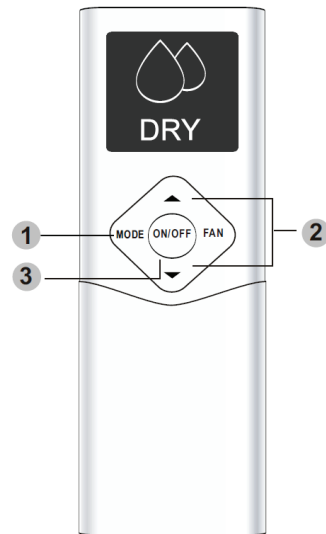

FAN Mode Operation

1. Press the MODE button to select FAN mode.
2. Press the FAN button to select the fan speed.
3. Press the ON/OFF button to start the unit.

Note: A temperature cannot be set when in FAN mode. As a result, your remote control's LCD screen will not display the temperature.

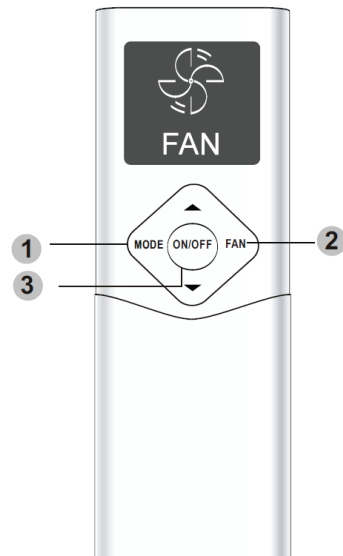

Basic Functions

HEAT Mode Operation

1. Press the MODE button to select HEAT mode.
2. Set your desired temperature using the temp ▲ or temp ▼ buttons.
3. Press the FAN button to select the fan speed.
4. Press the ON/OFF button to start the unit.

Note: As the outdoor temperature drops, the performance of your unit during HEAT mode may be affected. In such instances, it is recommended to use an additional heating appliance in conjunction with this air conditioner.

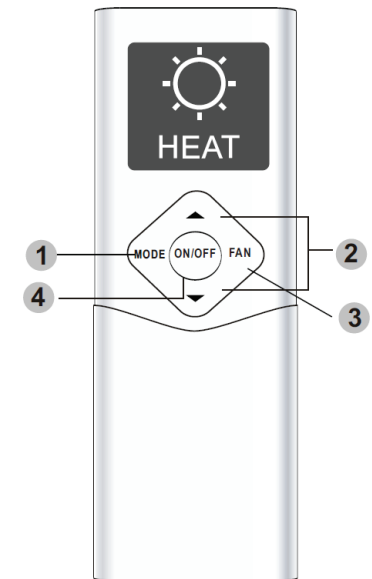

Basic Functions

Setting the TIMER function

Your air conditioning unit has two timer-related features:



- **TIMER ON** - Sets the amount of delay before the unit will automatically turn on.
- **TIMER OFF** - Sets the amount of time before the unit will turn itself off.

TIMER ON:

The TIMER ON feature allows you to set a fixed period of time, after which the unit will automatically turn itself on. For example, it can be scheduled to turn on when the user arrives home from work.

1. Press the TIMER button. The timer on indicator  and the time amount will display.

Note: This value indicates the amount of time left before the unit turns itself on. Activating TIMER ON with a value of 2h at 1 p.m. will turn the unit on at 3 p.m.

2. Press the temp  or temp  buttons repeatedly to configure the time that the unit should turn itself on.

3-4. After 3 seconds, the TIMER ON feature will be active. The digital display on your remote controller will then return to displaying the temperature.

The  indicator remains on and the feature is now activated.

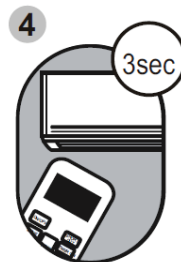
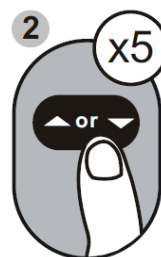
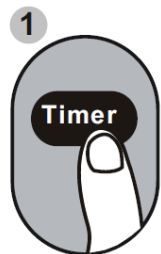

Ex: Setting the unit to turn on after 2.5 hours.

Basic Functions



Setting the TIMER function

TIMER OFF:

The TIMER OFF feature allows you to set a fixed period of time, after which the unit will automatically turn itself off. For example, it can be scheduled to turn off when the user leaves home for work.

1. Press the TIMER button. The timer off indicator  and the time amount will display.

Note: This value indicates the amount of time left before the unit turns itself off. Activating TIMER OFF with a value of 5h at 2 p.m. will turn the unit off at 7 p.m.

2. Press the temp  or temp  buttons repeatedly to configure the time that the unit should turn itself off.

3-4. After 3 seconds, the TIMER OFF feature will be active. The digital display on your remote controller will then return to displaying the temperature.

The  indicator remains on and the feature is now activated.

Note: When configuring the TIMER ON or TIMER OFF features, the configuration process will increase/decrease in 30 minute increments until the value reaches 10 hours. After 10 hours, the configuration will increase/decrease in 1 hour increments. Either function can be turned off by setting the timer to "0hr". 24 hr limit max.

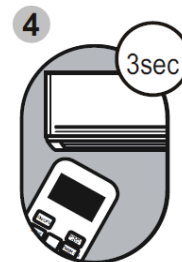
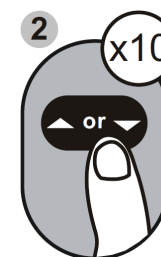
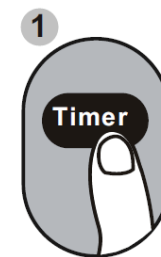

Ex: Setting the unit to turn off after 5 hours.

Basic Functions

Setting the TIMER function

Setting TIMER ON and TIMER OFF simultaneously:

Users are able to configure both the ON and OFF settings of the timer function. Be sure to note that the time periods that are set for either of the functions are the amount of hours after the current time.

Ex: If the current time is 1 p.m., and the user wants the system to turn itself on at 7 p.m. and run for 2 hours, they would do the following:

Configure the TIMER ON feature of the system to turn itself on in 6 hours:

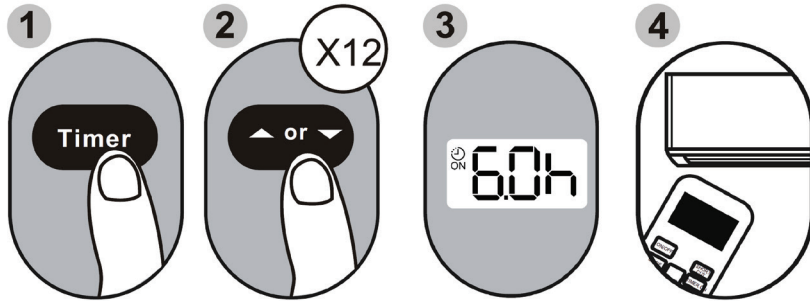

Configure the TIMER OFF feature of the system to turn itself off in 8 hours:

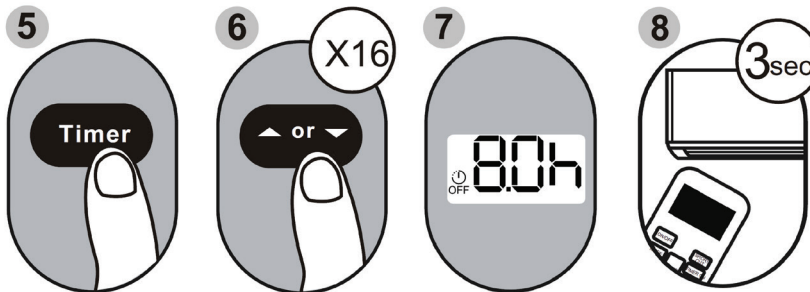

11

Basic Functions

Setting the TIMER function

The example on page 11 shows how to set the system to turn on after 6 hours, operate for 2 hours, and then turn itself off. See the figure below:

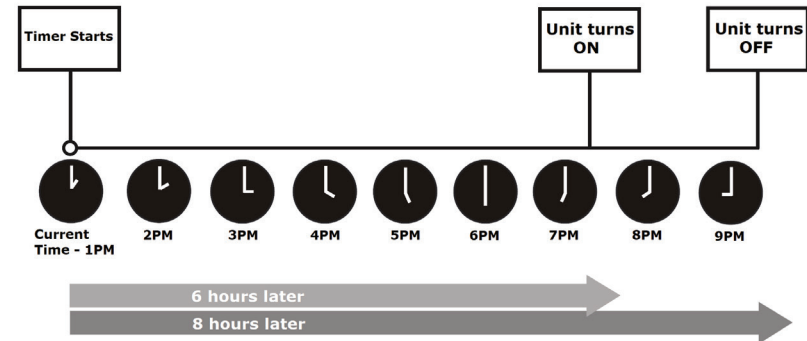

The remote display will be as shown:

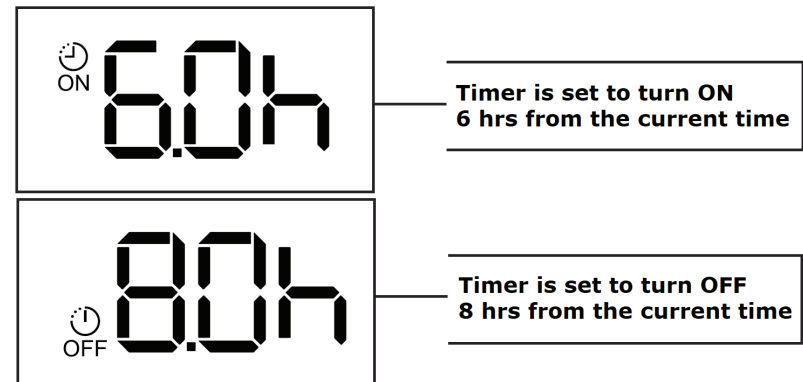

Note: If the user wishes to incorporate the scheduling feature, which will enable the ability to set specific times of each day of the week where the unit will turn off and on, they may purchase the Pioneer Wireless Internet Access & Control Module. This accessory is sold separately, and is available at www.pioneerminisplit.com.

12

Advanced Functions

ECO Feature (COOL mode only)

The ECO button is used to enter the system's energy-efficient mode.

When the unit is in cooling mode, pressing this button will adjust the temperature to 75°F (24°C) and the fan speed will change to AUTO. If the current set temperature is set **above** 75°C/24°C, then the fan speed will be changed to AUTO and the set temperature will not change.

Note: Pressing the ECO button, or modifying the mode/adjusting the set temperature to below 75°C/24°C will take the system out of ECO mode.

When in ECO mode, the temperature should be set to 75°C/24°C or greater. If this results in insufficient cooling and discomfort, the ECO button should be pressed again to take the system out of ECO mode.

Sleep Mode

Holding down the ECO button for 2 seconds will put the system into sleep mode. Sleep mode is typically meant for periods of lower cooling requirements, such as during typical sleeping hours. This mode will result in decreased energy use, and can only be activated via remote control.

For more details, please refer to the "sleep mode" section of the system user manual.

Note: Sleep mode is unavailable during FAN or DRY mode.

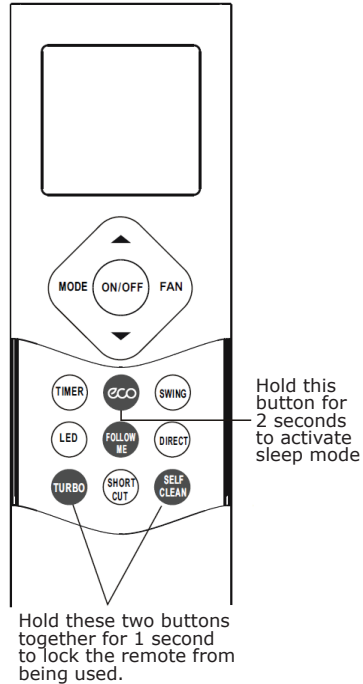

Lock Feature

Press the turbo button and the self-clean button together for one second to lock or unlock the remote's button board.

"Follow Me" Feature

The "Follow Me" button enables the remote controller to measure the temperature at its current location and send this value to the air conditioning system every 3 minutes. When using AUTO, COOL, or HEAT mode, prioritizing the temperature nearest to the user may ensure better comfort.

Advanced Functions

Silent Mode

Holding the FAN button for 2 seconds will activate/de-activate silent mode. This feature is only available to certain models. Use this feature to run the system more quietly. When running in this mode, the system may experience a diminished heating or cooling output capacity.

Vacation Mode

Pressing the ▼ button twice in one second will put the system into vacation mode. Under vacation mode, the system will remain at 46°F(8°C) and the indoor unit display will show "FP", meaning freeze protection.

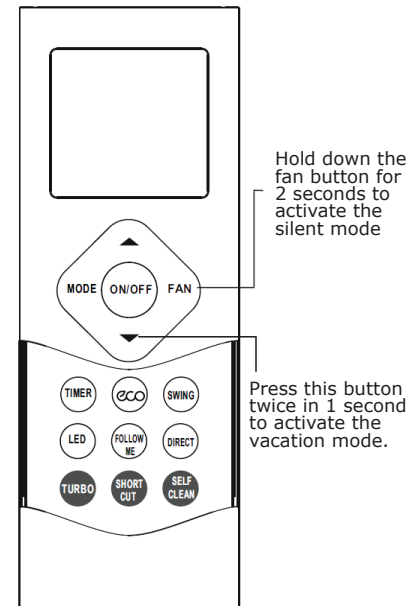

Shortcut Feature

This is used to restore current settings or to resume previous settings. Push the shortcut button when the remote control is on and the system will automatically revert back to its previous settings, such as its operating mode, set temperature, fan speed level, and the unit's sleep mode feature (if active).

If held for more than 2 seconds, the system will automatically restore its current operating settings in use at the time.

Self-Clean Mode

Airborne bacteria can manifest in the moisture that condenses in or around the unit's heat exchanger. With regular use, most of this moisture has usually evaporated. When self-clean mode is active, the system will clean itself and afterwards will turn itself off automatically. This feature can be used as often as needed, but is only available in COOL (AUTO), or DRY mode.

Turbo Mode

Turbo mode forces the unit to reach the set temperature in the quickest time possible. In cooling mode, this will result in the unit jump-starting the process with strong wind output. In heating mode, the unit may employ the use of a supplementary electric heater, for units that are equipped with this feature.