

PLEASE LEAVE FOR THE HOME OWNER

DO'S

- Coloured sinks should only be cleaned with soapy water and a soft cloth or sponge, then rinsed and towelled dry.
- The colouring is a solid coating (Physical Vapour Deposit) on the surface of the stainless steel only - harsh scratching should be avoided.
- It is highly recommended to use the wire bowl protector provided with the sink, to protect the bottom of the bowl

DONT'S

- Never use steel wool in or on the sink (steel wool should be avoided with any stainless steel sink, as it can leave steel deposits on the sink, which can cause rust).
- Never use harsh abrasive cleaning pads to clean coloured sinks.
- Never use harsh chemicals or bleaches to clean coloured sinks.
- Do not store harsh chemical (acids, chlorines, bleaches etc.) under the sink, as the vapours (even from the closed containers) can cause rusting on the underside of the stainless steel sinks.
- Avoid prolonged contact with ordinary steel containers (e.g. tin cans), as these can rust and stain the sink.
- Avoid prolonged exposures to acids from fruit, fruit juices, salts, tea bags etc., as these may leave stains.
- Avoid leaving liquid soaps, hand sanitizing liquids etc. to dry on the surface of the sink, as these may leave stains.

IT IS HIGHLY RECOMMENDED THAT THE ACTUAL SINK BE PRESENT AT TIME OF INSTALLATION



CHECK MODEL

The model number on the sink packaging must match the model of sink the customer ordered. Do not install if incorrect.



CHECK THE CONDITION

Inspect the sink for any visible defects. Do not install the sink if defects are found. Contact your sink retailer / point of purchase.



AVOID CUTS

The perimeter and punch-outs on the sink may contain sharp edges. Handle the sink carefully to avoid personal injury.

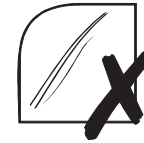

AVOID SCRATCHES

Stainless steel can be scratched if proper care is not taken during installation.

Template supplied in carton is for undermount installation only.
For topmount installation see www.oliverisinks.com or use the below dimensions:

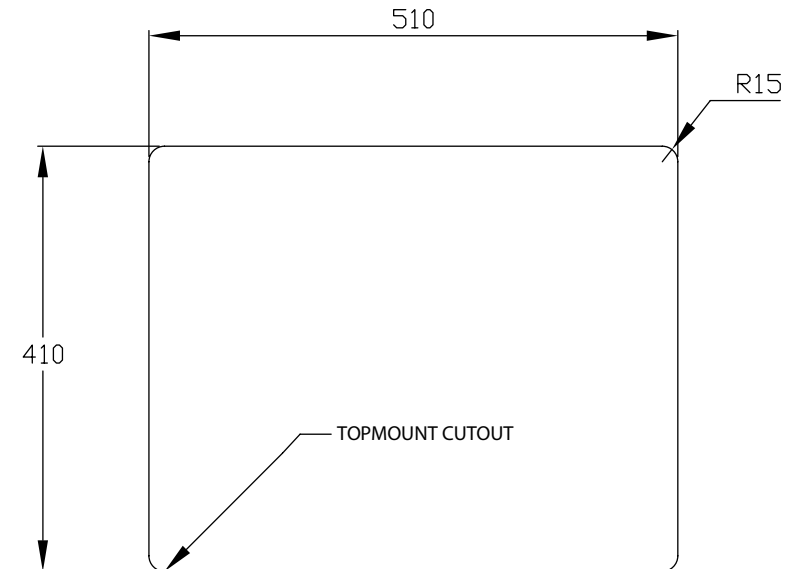

Any advice, recommendation, information, assistance or service provided by Tasman Sinkware in relation to goods manufactured by it or their use and installation, is given in good faith and is believed by Tasman Sinkware to be appropriate and reliable. However, any advice, recommendation, information, assistance or service is provided by Tasman Sinkware without responsibility or liability.

IF COUNTER / BENCHTOP IS SUPPLIED WITH CUT-OUT, SKIP STEPS MARKED WITH*

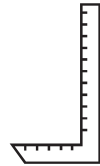

CHECK SPACE & LEVEL

Use a level to check the counter/benchtop – if not level, have rectified. Ensure there is adequate space for tapware (including a splash back if specified). Check space for installation (underneath) and operation (above). Particular care must be taken when a thick splash back is used (it may interfere with tapware location and operation). Ensure the cabinet will not foul the sink mounting flange or basins.



TEMPLATE *

Template supplied in carton is for undermount installation only. For topmount installation see www.oliverisinks.com or use the drawing on the reverse page.



MARK CUT OUT *

Carefully mark out the template (or follow drawing instructions). Once the hole is marked out, use the template to conduct a final check before cutting. **IMPORTANT** If you have traced the sink itself to mark your cut out, the hole must be cut 10mm inside the marked line.



CUT & FINISH HOLE *

Re-check the position and cut out shape you have traced before cutting. Ensure there are no obstacles below that might interfere with cutting. Drill pilot holes to accept an appropriate cutting tool for the counter/benchtop material (wear suitable personal protection equipment). Cut just inside the template mark (or 10mm inside the sink tracing).

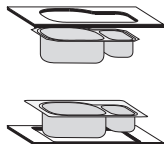

TRIAL FIT THE SINK

Check that all clips are folded in so they will adequately clear the cut-out. Carefully position the sink into the cut-out to make sure it fits correctly. If the fit is not correct, remove the sink and proceed with remedial work. Perform another trial fit after corrections have been made.



MASKING

If using a sealant, masking is necessary to prevent sealant overrun. It is recommended that the edge of the sink and the edge of the cutout are both covered with a suitable masking tape. This tape should be removed within 2 days of application.



APPLY SEALANT

Apply suitable sealant recommended for both the counter/benchtop material being used and for stainless steel. Neutral-cure sealant will not damage stainless steel. It may be easier to apply sealant after preparing your clamping equipment. Do not allow the sealant to dry before the sink is clamped to the counter/benchtop.

UNDERMOUNT ONLY

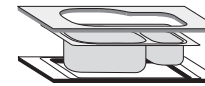
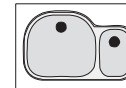

Above shows sandwich method where sink is clamped between a lower support board (with routed edge) and the upper counter / benchtop using method A.

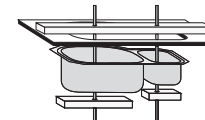

Above shows how threaded rod and timber bearers may be used to clamp the sink in place while fastening to the counter / benchtop using methods B and C.

Do not overtighten as this may damage the sink.

FITTING THE SINK

Position and align the sink correctly in the cutout (some threaded rod and timber bearers will help to clamp the sink in place) and either

'A' Sandwich Method: RECOMMENDED FOR BOTH THIN AND THICK COUNTER/BENCHTOP. Firmly fix a support board into / over the cabinet and cut the sink hole so that the sink flange will sit above the edge of the board. Slightly rout the edge so that the sink flange will sit flush with the top surface. Test for fit. Install sink and seal between flange and support board. Apply sealant to the underside edge of the cutout on counter/benchtop material and position it over the support board to sandwich the sink in place. Fasten the counter/benchtop securely.

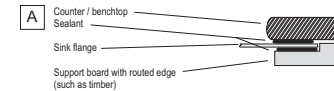

'B' Bond: For minimum 1" / 25mm thick material. Bond it to the underside of the counter/benchtop with a structural high strength epoxy compound. **NOT RECOMMENDED TO BE USED WHEN FITTING SINK TO THINNER COUNTER/BENCHTOPS.**



'C' Bolt: For minimum 1" / 25mm thick material. Bolt it to the counter / benchtop using "molly" assemblies. Care must be taken during drilling and tightening to avoid cracking. **NOT RECOMMENDED TO BE USED WHEN FITTING SINK TO THINNER COUNTER/BENCHTOPS.**

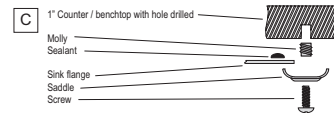

If you have any doubts, confirm the correct mounting method for your material by consulting the counter/benchtop supplier.

TOPMOUNT ONLY

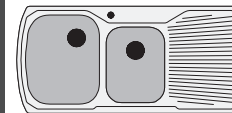

FITTING THE SINK Position and align the sink correctly in the cutout and lower it onto the counter/benchtop. From underneath, install and tighten the clips with a screwdriver using a suitable tightening sequence (tighten from the centre of the sink to the outer edge) until the sink is secure and no gaps are visible. Take extra care if using power tools as over-tightening can damage clips.

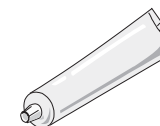

ADDITIONAL SEALANT

Apply additional sealant / caulking compound around the join where the counter/benchtop and the stainless steel sink meet. Check that the caulking product is mildew resistant and is suitable for use on the counter/benchtop material and also is suitable for use on stainless steel. Clean away any excess before it dries. Note: Additional sealant should always be used if gaps are apparent after the sink has been clamped to the counter/benchtop



PLUMBING & TAPWARE

IMPORTANT - Connections to plumbing should always be done by a licensed plumber. Fit supplied basket wastes to sink bowls. Install tapware according to manufacturer's instructions. Care should be taken when fitting wastes to the sink. Follow the instructions provided with the wastes.