

SPLIT-TYPE AIR CONDITIONERS

INDOOR UNIT

MSY-GW25VFD MSY-GW35VFD MSY-GW42VFD

MSY-GW50VFD MSY-GW60VFD MSY-GW71VFD MSY-GW80VFD



OPERATING INSTRUCTIONS

For user

- To use this unit correctly and safely, be sure to read these operating instructions before use.

English

CONTENTS

■ SAFETY PRECAUTIONS	1
■ NAME OF EACH PART	3
■ PREPARATION BEFORE OPERATION	4
■ SELECTING OPERATION MODES	5
■ FAN SPEED AND AIRFLOW DIRECTION ADJUSTMENT	6
■ LONG OPERATION	7
■ POWERFUL OPERATION	7
■ I-SAVE OPERATION	7
■ ECONO COOL OPERATION	8
■ TIMER OPERATION (ON/OFF TIMER)	8
■ WEEKLY TIMER OPERATION	9
■ DEMAND RESPONSE AND INDOOR UNIT OPERATION	10
■ EMERGENCY OPERATION	10
■ AUTO RESTART FUNCTION	10
■ CLEANING	11
■ WHEN YOU THINK THAT TROUBLE HAS OCCURRED	12
■ WHEN THE AIR CONDITIONER IS NOT GOING TO BE USED FOR A LONG TIME	13
■ INSTALLATION PLACE AND ELECTRICAL WORK	13
■ SPECIFICATIONS	13

SAFETY PRECAUTIONS

Meanings of symbols displayed on indoor unit and/or outdoor unit

	WARNING (Risk of fire)	This unit uses a flammable refrigerant. If refrigerant leaks and comes in contact with fire or heating part, it will create harmful gas and there is risk of fire.
	Read the OPERATING INSTRUCTIONS carefully before operation.	
	Service personnel are required to carefully read the OPERATING INSTRUCTIONS and INSTALLATION MANUAL before operation.	
	Further information is available in the OPERATING INSTRUCTIONS, INSTALLATION MANUAL, and the like.	

- Since rotating parts and parts which could cause an electric shock are used in this product, be sure to read these "Safety Precautions" before use.
- Since the cautionary items shown here are important for safety, be sure to observe them.
- After reading this manual, keep it together with the installation manual in a handy place for easy reference.
- Be sure to receive a guarantee card from your dealer and check that the purchased date and shop name, etc. are entered correctly.

Marks and their meanings

- WARNING :** Incorrect handling could cause serious hazard, such as death, serious injury, etc. with a high probability.
- CAUTION :** Incorrect handling could cause serious hazard depending on the conditions.

WARNING	
	Do not connect the power cord to an intermediate point, use an extension cord, or connect multiple devices to a single AC outlet. • This may cause overheating, fire, or electric shock.
	Make sure the power plug is free of dirt and insert it securely into the outlet. • A dirty plug may cause fire or electric shock.
	Do not bundle, pull, damage, or modify the power cord, and do not apply heat or place heavy objects on it. • This may cause fire or electric shock.
	Do not turn the breaker OFF/ON or disconnect/connect the power plug during operation. • This may create sparks, which can cause fire. • After the indoor unit is switched OFF with the remote controller, make sure to turn the breaker OFF or disconnect the power plug.
	Do not expose your body directly to cool air for a prolonged length of time. • This could be detrimental to your health.
	The unit should not be installed, relocated, disassembled, altered, or repaired by the user. • An improperly handled air conditioner may cause fire, electric shock, injury, or water leakage, etc. Consult your dealer. • If the power supply cord is damaged, it must be replaced by the manufacturer or its service agent in order to avoid a hazard.



Meanings of symbols used in this manual

- : Be sure not to do.
- : Be sure to follow the instruction.
- : Never insert your finger or stick, etc.
- : Never step onto the indoor/outdoor unit and do not put anything on them.
- : Danger of electric shock. Be careful.
- : Be sure to disconnect the power supply plug from the power outlet.
- : Be sure to shut off the power.
- : Risk of fire.



	When installing, relocating, or servicing the unit, make sure that no substance other than the specified refrigerant (R32) enters the refrigerant circuit. • Any presence of foreign substance such as air can cause abnormal pressure rise and may result in explosion or injury. • The use of any refrigerant other than that specified for the system will cause mechanical failure, system malfunction, or unit breakdown. In the worst case, this could lead to a serious impediment to securing product safety.
	This appliance is not intended for use by persons (including children) with reduced physical, sensory or mental capabilities, or lack of experience and knowledge, unless they have been given supervision or instruction concerning use of the appliance by a person responsible for their safety.
	Children should be supervised to ensure that they do not play with the appliance.
	Do not insert your finger, a stick, or other objects into the air inlet or outlet. • This may cause injury, since the fan inside rotates at high speeds during operation.
	In case of an abnormal condition (such as a burning smell), stop the air conditioner and disconnect the power plug or turn the breaker OFF. • A continued operation in the abnormal state may cause a malfunction, fire, or electric shock. In this case, consult your dealer.

SAFETY PRECAUTIONS

⚠ WARNING

	<p>When the air conditioner does not cool or heat, there is a possibility of refrigerant leakage. If any refrigerant leakage is found, stop operations and ventilate the room well and consult your dealer immediately. If a repair involves recharging the unit with refrigerant, ask the service technician for details.</p> <ul style="list-style-type: none"> The refrigerant used in the air conditioner is not harmful. Normally, it does not leak. However, if refrigerant leaks and comes in contact with fire or heating part of such a fan heater, kerosene heater, or cooking stove, it will create harmful gas and there is risk of fire.
	<p>The user should never attempt to wash the inside of the indoor unit. Should the inside of the unit require cleaning, contact your dealer.</p> <ul style="list-style-type: none"> Unsuitable detergent may cause damage to plastic material inside the unit, which may result in water leakage. Should detergent come in contact with electrical parts or the motor, it will result in a malfunction, smoke, or fire. The appliance shall be stored in a room without continuously operating ignition sources (for example: open flames, an operating gas appliance or an operating electric heater). Be aware that refrigerants may not contain an odour. Do not use means to accelerate the defrosting process or to clean the appliance, other than those recommended by the manufacturer. Do not pierce or burn. <p>The indoor unit must be installed in rooms which exceed the floor space specified. Please consult your dealer.</p>
	<p>This appliance is intended to be used by expert or trained users in shops, in light industry and on farms, or for commercial use by lay persons.</p>

⚠ CAUTION

	<p>Do not touch the air inlet or the aluminum fins of the indoor/outdoor unit.</p> <ul style="list-style-type: none"> This may cause injury. 	
	<p>Do not use insecticides or flammable sprays on the unit.</p> <ul style="list-style-type: none"> This may cause a fire or deformation of the unit. 	
	<p>Do not expose pets or houseplants to direct airflow.</p> <ul style="list-style-type: none"> This may cause injury to the pets or plants. 	
	<p>Do not place other electric appliances or furniture under the indoor/outdoor unit.</p> <ul style="list-style-type: none"> Water may drip down from the unit, which may cause damage or malfunction. 	
	<p>Do not leave the unit on a damaged installation stand.</p> <ul style="list-style-type: none"> The unit may fall and cause injury. 	
	<p>Do not step on an unstable bench to operate or clean the unit.</p> <ul style="list-style-type: none"> This may cause injury if you fall down. 	
	<p>Do not pull the power cord.</p> <ul style="list-style-type: none"> This may cause a portion of the core wire to break, which may cause overheating or fire. 	
	<p>Do not charge or disassemble the batteries, and do not throw them into a fire.</p> <ul style="list-style-type: none"> This may cause the batteries to leak, or cause a fire or explosion. 	
	<p>Do not operate the unit for more than 4 hours at high humidity (80% RH or more) and/or with windows or outside door left open.</p> <ul style="list-style-type: none"> This may cause the water condensation in the air conditioner, which may drip down, wetting or damaging the furniture. The water condensation in the air conditioner may contribute to growth of fungi, such as mold. 	
	<p>Do not use the unit for special purposes, such as storing food, raising animals, growing plants, or preserving precision devices or art objects.</p> <ul style="list-style-type: none"> This may cause deterioration of quality, or harm to animals and plants. 	
	<p>Do not expose combustion appliances to direct airflow.</p> <ul style="list-style-type: none"> This may cause incomplete combustion. 	
	<p>Never put batteries in your mouth for any reason to avoid accidental ingestion.</p> <ul style="list-style-type: none"> Battery ingestion may cause choking and/or poisoning. 	
		<p>Before cleaning the unit, switch it OFF and disconnect the power plug or turn the breaker OFF.</p> <ul style="list-style-type: none"> This may cause injury, since the fan inside rotates at high speeds during operation. <p>When the unit will be unused for a long time, disconnect the power plug or turn the breaker OFF.</p> <ul style="list-style-type: none"> The unit may accumulate dirt, which may cause overheating or fire.



Replace all batteries of the remote controller with new ones of the same type.

- Using an old battery together with a new one may cause overheating, leakage, or explosion.

If the battery fluid comes in contact with your skin or clothes, wash them thoroughly with clean water.

- If the battery fluid comes in contact with your eyes, wash them thoroughly with clean water and immediately seek medical attention.

Ensure that the area is well-ventilated when the unit is operated together with a combustion appliance.

- Inadequate ventilation may cause oxygen starvation.

Turn the breaker OFF when you hear thunder and there is a possibility of a lightning strike.

- The unit may be damaged if lightning strikes.

After the air conditioner is used for several seasons, perform inspection and maintenance in addition to normal cleaning.

- Dirt or dust in the unit may create an unpleasant odor, contribute to growth of fungi, such as mold, or clog the drain passage, and cause water to leak from the indoor unit. Consult your dealer for inspection and maintenance, which require specialized knowledge and skills.



Do not operate switches with wet hands.

- This may cause electric shock.

Do not clean the air conditioner with water or place an object that contains water, such as a flower vase, on it.

- This may cause fire or electric shock.



Do not step on or place any object on the outdoor unit.

- This may cause injury if you or the object falls down.

⚠ IMPORTANT

Dirty filters cause condensation in the air conditioner which will contribute to the growth of fungi such as mold. It is therefore recommended to clean air filters every 2 weeks.

For installation

⚠ WARNING



Consult your dealer for installing the air conditioner.

- It should not be installed by the user since installation requires specialized knowledge and skills. An improperly installed air conditioner may cause water leakage, fire, or electric shock.

Provide a dedicated power supply for the air conditioner.

- A non-dedicated power supply may cause overheating or fire.

Do not install the unit where flammable gas could leak.

- If gas leaks and accumulates around the outdoor unit, it may cause an explosion.



Earth the unit correctly.

- Do not connect the earth wire to a gas pipe, water pipe, lightning rod, or a telephone earth wire. Improper earthing may cause electric shock.

⚠ CAUTION



Install an earth leakage breaker depending on the installation location of the air conditioner (such as highly humid areas).

- If an earth leakage breaker is not installed, it may cause electric shock.

Ensure that the drain water is properly drained.

- If the drain passage is improper, water may drip down from the indoor/outdoor unit, wetting and damaging the furniture.

In case of an abnormal condition

Immediately stop operating the air conditioner and consult your dealer.

NAME OF EACH PART

Indoor unit

<GW25/35/42>

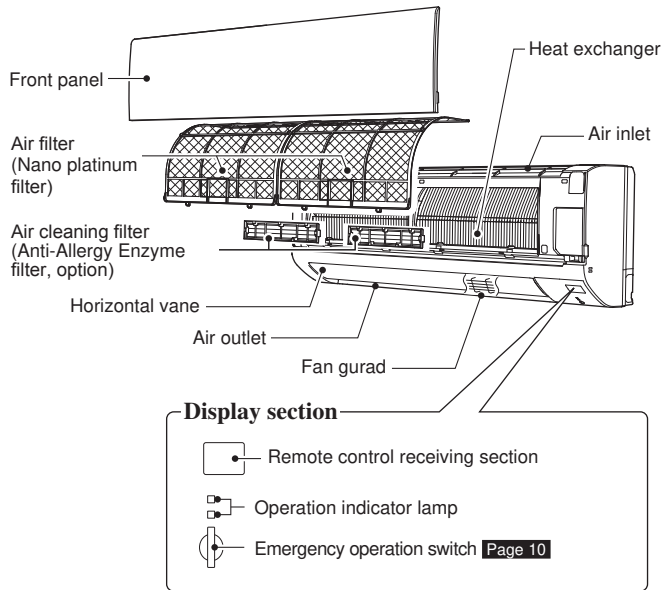

<GW71/80>

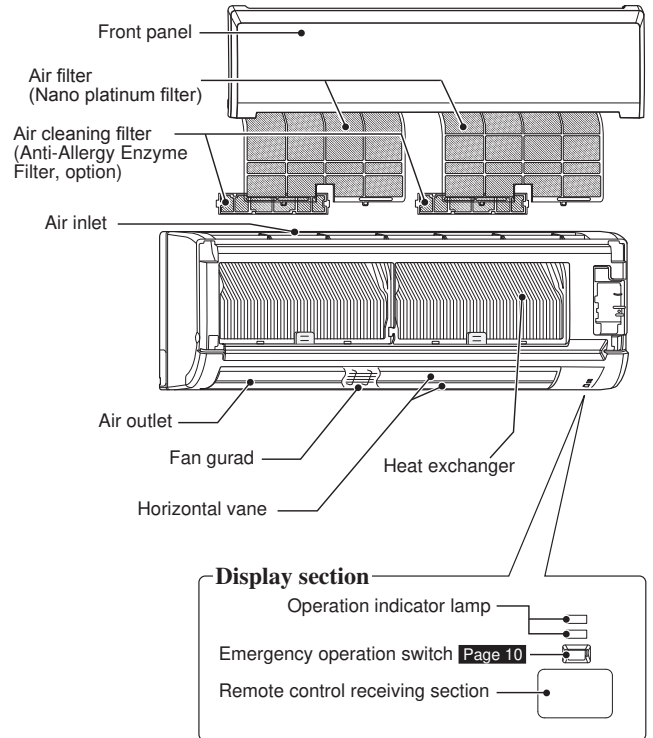

<GW50/60>

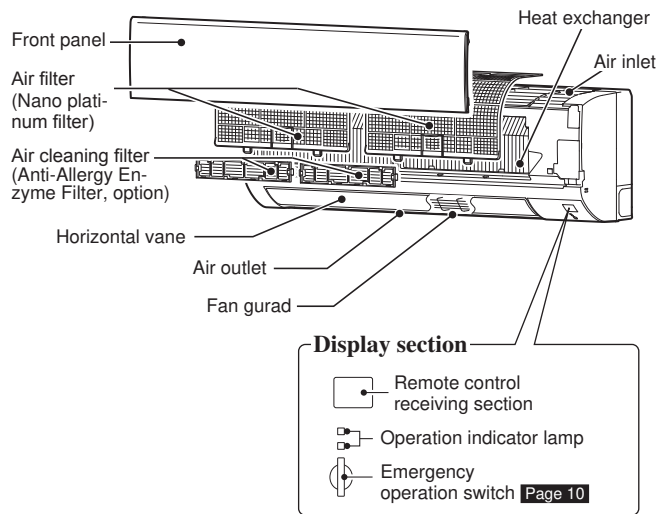

Outdoor unit

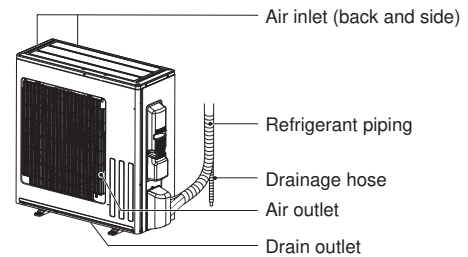

Outdoor units may be different in appearance.

NAME OF EACH PART

Remote controller

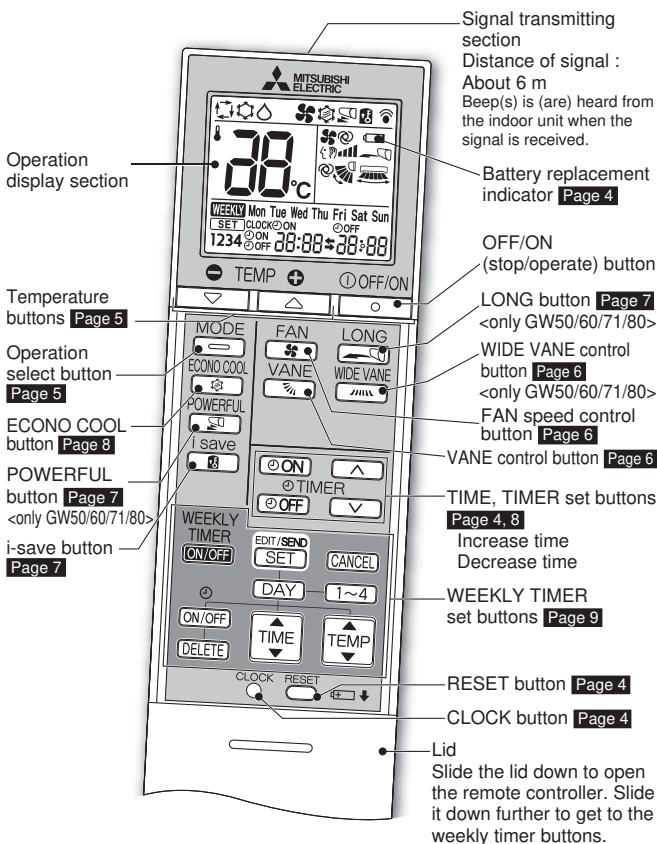

Remote controller holder

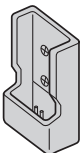

- Install the remote controller holder in a place where the signal can be received by the indoor unit.
- When the remote controller is not used, place it in this holder.

Only use the remote controller provided with the unit.

Do not use other remote controllers. If two or more indoor units are installed in proximity to one another, an indoor unit that is not intended to be operated may respond to the remote controller.

PREPARATION BEFORE OPERATION

Before operation: Insert the power supply plug into the power outlet and/or turn the breaker on.

Installing the remote controller batteries

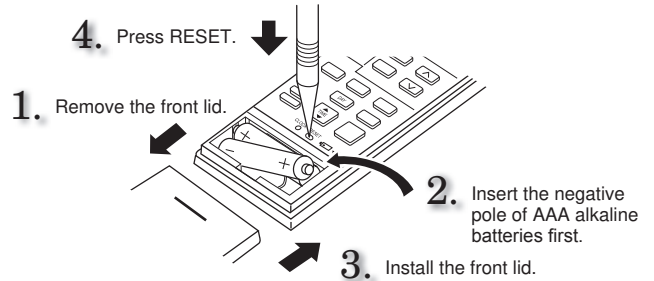

Note:

- Make sure the polarity of the batteries is correct.
- Do not use manganese batteries and leaking batteries. The remote controller could malfunction.
- Do not use rechargeable batteries.
- The battery replacement indicator lights up when the battery is running low. In about 7 days after the indicator starts lights up, the remote controller stops working.
- Replace all batteries with new ones of the same type.
- Batteries can be used for approximately 1 year. However, batteries with expired shelf lives last shorter.
- Press RESET gently using a thin instrument. If the RESET button is not pressed, the remote controller may not operate correctly.

Setting current time

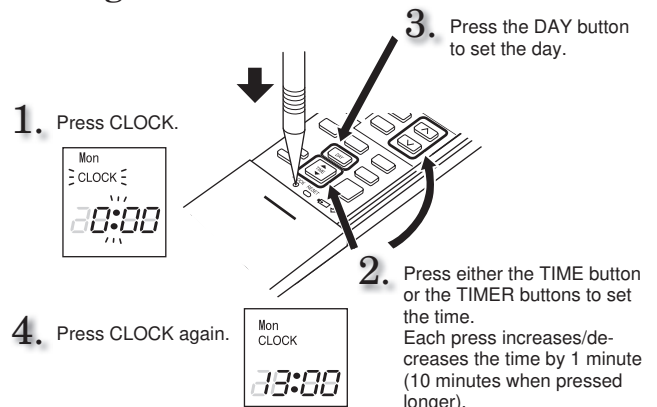

Note:

- Press CLOCK gently using a thin instrument.

Note:

How to set remote controller exclusively for a particular indoor unit

A maximum of 4 indoor units with wireless remote controllers can be used in a room.

To operate the indoor units individually with each remote controller, assign a number to each remote controller according to the number of the indoor unit.

This setting can be set only when all the following conditions are met:

- The remote controller is powered OFF.

(1) Hold down [1~4] button on the remote controller for 2 seconds to enter the pairing mode.

(2) Press [1~4] button again and assign a number to each remote controller. Each press of [1~4] button advances the number in the following order: 1 → 2 → 3 → 4.

(3) Press [EDIT/SEND/SET] button to complete the pairing setting.

After you turn the breaker ON, the remote controller that first sends a signal to an indoor unit will be regarded as the remote controller for the indoor unit. Once they are set, the indoor unit will only receive the signal from the assigned remote controller afterwards.

SELECTING OPERATION MODES

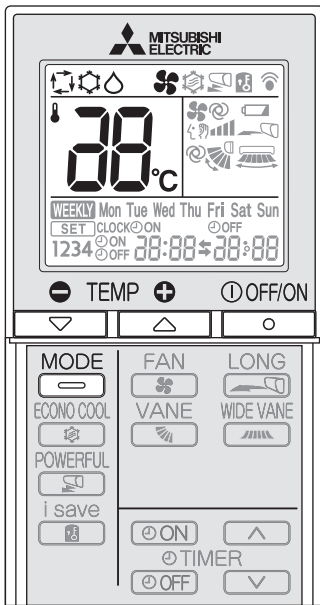

1 Press to start the operation.

2 Press to select operation mode. Each press changes mode in the following order:

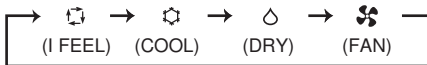

3 Press or to set the temperature. Each press raises or lowers the temperature by 1°C.

Press to stop the operation.
 • The same setting is selected the next time by simply pressing .

Note:

Operation indicator lamp

The operation indicator lamp shows the operation state of the unit.

Indication	Operation state	Room temperature
	The unit is operating to reach the set temperature	About 2°C or more away from set temperature
	The room temperature is approaching the set temperature	About 1 to 2°C from set temperature
	Demand Response mode Page 10	—

Lit Blinking Not lit

I FEEL mode

The unit selects the operation mode according to the room temperature when I FEEL is selected. When the room temperature is higher than 25°C, COOL is selected (set temperature: 24°C). When the room temperature is lower than 25°C, DRY is selected. However, when operation is stopped and then started within 2 hours, the mode which has been selected previously is operated.

Note:

During COOL operation, the set temperature may not be changed when the room temperature is more than 2°C higher than the set temperature. In this case, please wait until the room temperature drops to within 2°C of the set temperature.

COOL mode

Enjoy cool air at your desired temperature.

DRY mode

Dehumidify your room. The room may be cooled slightly. Temperature cannot be set during DRY mode.

FAN mode

Circulate the air in your room.

Note:

After COOL/DRY mode operation, it is recommended to operate in the FAN mode to dry inside the indoor unit.



FAN SPEED AND AIRFLOW DIRECTION ADJUSTMENT

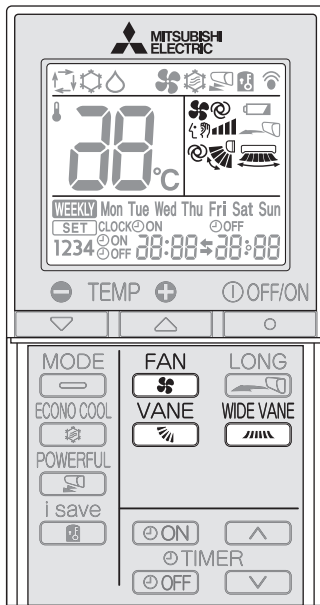

Fan speed

1 Press **FAN** to select fan speed. Each press changes fan speed in the following order:

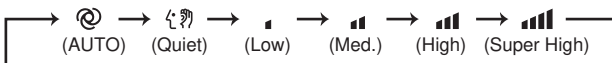

- Two short beeps are heard from the indoor unit when set to AUTO.
- Use higher fan speed to cool the room quicker. It is recommended to lower the fan speed once the room is cool.
- Use lower fan speed for quiet operation.

Up-down Airflow direction

1 Press **VANE** to select airflow direction. Each press changes airflow direction in the following order:

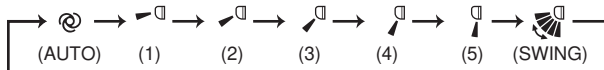

- Two short beeps are heard from the indoor unit when set to AUTO.

(AUTO) The vane is set to the most efficient airflow direction. :horizontal position.

(Manual) For efficient air conditioning, select the upper position for COOL/DRY, and the lower position for FAN. If the lower position is selected during COOL/DRY, the vane automatically moves to the upward position after 0.5 to 1 hour to prevent any condensation from dripping.

(Swing) The vane moves up and down intermittently.

Left-right Airflow direction

<GW25/35/42>

■ To change the horizontal airflow direction.

Move the vertical vane manually before starting operation.

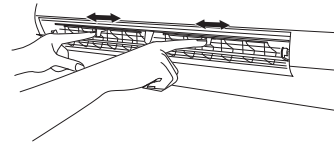

<GW50/60>

1 Press **WIDE VANE** to select horizontal airflow direction. Each press changes airflow direction in the following order:

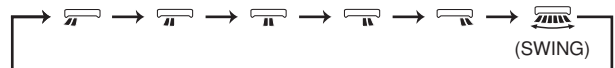

<GW71/80>

1 Press **WIDE VANE** to select horizontal airflow direction. Each press changes airflow direction in the following order:

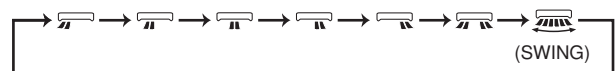

LONG OPERATION

<GW50/60/71/80>

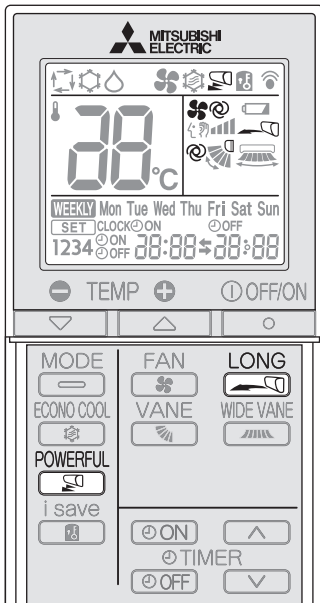

1 Press to start LONG operation.

- Fan speed increases and the horizontal vane moves to the position for LONG mode.
- Air reaches to longer distance.

Press again to cancel LONG operation.

- LONG operation is cancelled when the OFF/ON, VANE, or ECONO COOL button is pressed.

POWERFUL OPERATION

<GW50/60/71/80>

1 Press during COOL mode **page 5** to start POWERFUL operation.

- Fan speed : Exclusive speed for POWERFUL mode
- Horizontal vane : Set position, or downward airflow position during AUTO setting

- Temperature cannot be set during POWERFUL operation.

Press again to cancel POWERFUL operation.

- POWERFUL operation is also cancelled automatically in 15 minutes, or when the OFF/ON, FAN, ECONO COOL, or i-save button is pressed.

I-SAVE OPERATION

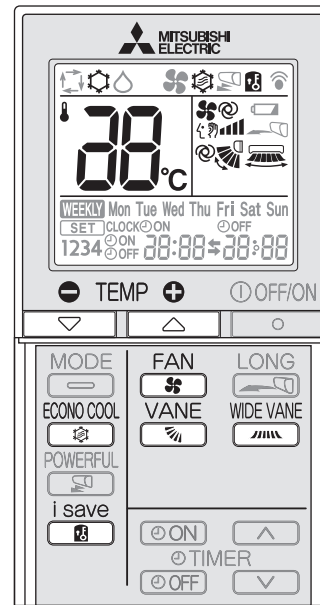

- A simplified set back function enables to recall the preferred (preset) setting with a single push of the button. Press the button again and you can go back to the previous setting in an instance.
- i-save operation cannot be set on the weekly timer.

1 Press during COOL or ECONO COOL mode to select i-save mode.

2 Set the temperature, fan speed, and airflow direction.

- The same setting is selected from the next time by simply pressing .
- One group of setting can be saved.
- Select the appropriate temperature, fan speed, and airflow direction according to your room.

Press again to cancel i-save operation.

- i-save operation is also cancelled when the MODE or POWERFUL button is pressed.

Note:

Example of use:

1. Low energy mode
Set the temperature 2°C to 3°C warmer in COOL mode. This setting is suitable for unoccupied room, and while you are sleeping.
2. Saving frequently used settings
Save your preferred setting for COOL/ECONO COOL. This enables you to select your preferred setting with a single push of the button.

ECONO COOL OPERATION

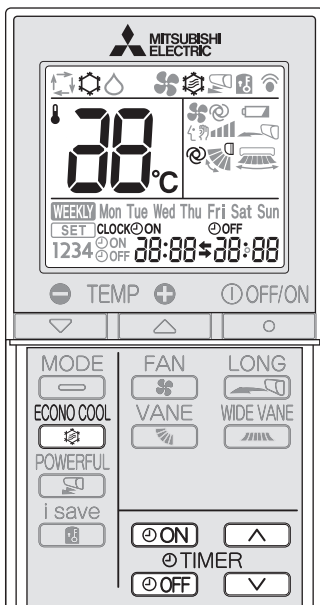

Swing airflow (change of air flow) makes you feel cooler than stationary airflow. The set temperature and the airflow direction are automatically changed by the microprocessor. It is possible to perform cooling operation with keeping comfort. As a result energy can be saved.

- 1 Press  during COOL mode [page 5](#) to start ECONO COOL operation.

The unit performs swing operation vertically in various cycles according to the temperature of airflow.

- Press  again to cancel ECONO COOL operation.

- ECONO COOL operation is cancelled when the VANE, LONG, or POWERFUL button is pressed.

TIMER OPERATION (ON/OFF TIMER)



- 1 Press  or  during operation to set the timer.

 (ON timer) : The unit turns ON at the set time.



 (OFF timer) : The unit turns OFF at the set time.

*  or  blinks.

* Make sure that the current time and day are set correctly. [Page 4](#)

- 2 Press  (Increase) and  (Decrease) to set the time of timer.

Each press increases or decreases the set time by 10 minutes.

- Set the timer while  or  is blinking.

Press  or  again to cancel timer.

Note:

- ON and OFF timers can be set together. ⚡ mark indicates the order of timer operations.
- If power failure occurs while ON/OFF timer is set, see [page 10](#) "AUTO RE-START FUNCTION".

WEEKLY TIMER OPERATION

- A maximum of 4 ON or OFF timers can be set for individual days of the week.
- A maximum of 28 ON or OFF timers can be set for a week.

E.g. : Runs at 24°C from waking up to leaving home, and runs at 27°C from getting home to going to bed on weekdays.
Runs at 27°C from waking up late to going bed early on weekends.

	Setting1	Setting2	Setting3	Setting4
Mon	ON 24°C 6:00	OFF 8:30	ON 17:30	OFF 22:00
Fri				
Sat	Setting1 ON 8:00	27°C		Setting2 OFF 21:00
Sun				

Note:

The simple ON/OFF timer setting is available while the weekly timer is on. In this case, the ON/OFF timer has priority over the weekly timer; the weekly timer operation will start again after the simple ON/OFF timer is complete.

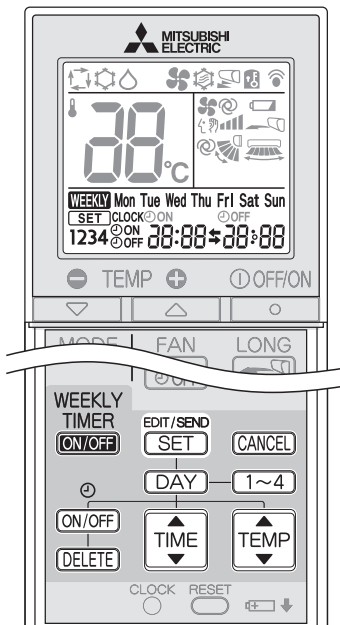

Setting the weekly timer

* Make sure that the current time and day are set correctly.

1 Press **EDIT/SEND SET** to enter the weekly timer setting mode.

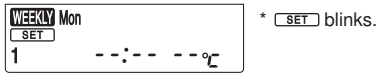

2 Press **DAY** and **1~4** to select setting day and number.

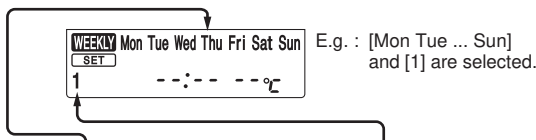

E.g. : [Mon Tue ... Sun] and [1] are selected.

Pressing **DAY** selects the day of the week to be set.

Pressing **1~4** selects the setting number.

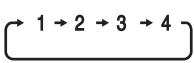
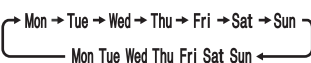

* All days can be selected.

3 Press **ON/OFF**, **TIME**, and **TEMP** to set ON/OFF, time, and temperature.



E.g. : [ON], [6:00] and [24°C] are selected.

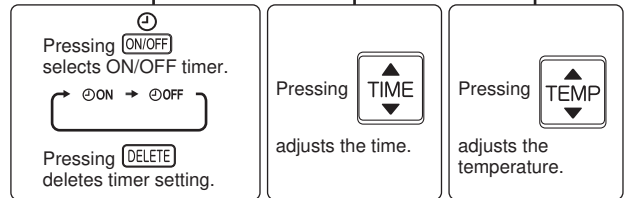

* Hold down the button to change the time quickly.

* The temperature can be set between 16°C and 31°C at weekly timer.

Press **DAY** and **1~4** to continue setting the timer for other days and/or numbers.

4 Press **EDIT/SEND SET** to complete and transmit the weekly timer setting.

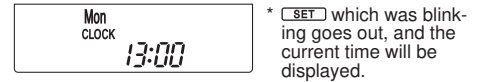

* **SET** which was blinking goes out, and the current time will be displayed.

Note:

- Press **EDIT/SEND SET** to transmit the setting information of weekly timer to the indoor unit. Point the remote controller toward the indoor unit for 3 seconds.
- When setting the timer for more than one day of the week or one number, **EDIT/SEND SET** does not have to be pressed per each setting. Press **EDIT/SEND SET** once after all the settings are complete. All the weekly timer settings will be saved.
- Press **EDIT/SEND SET** to enter the weekly timer setting mode, and press and hold **DELETE** for 5 seconds to erase all weekly timer settings. Point the remote controller toward the indoor unit.

5 Press **WEEKLY TIMER ON/OFF** to turn the weekly timer ON. (**WEEKLY** lights.)

* When the weekly timer is ON, the day of the week whose timer setting is complete, will light.

Press **WEEKLY TIMER ON/OFF** again to turn the weekly timer OFF. (**WEEKLY** goes out.)

Note:

The saved settings will not be cleared when the weekly timer is turned OFF.

Checking weekly timer setting

1 Press **EDIT/SEND SET** to enter the weekly timer setting mode.

* **SET** blinks.

2 Press **DAY** or **1~4** to view the setting of the particular day or number.

Press **CANCEL** to exit the weekly timer setting.

Note:

When all days of the week are selected to view the settings and a different setting is included among them, **---:--** will be displayed.

DEMAND RESPONSE AND INDOOR UNIT OPERATION

Demand response

This unit has demand response capability which is compliant with AS/NZS 4755.3.1.

To activate this function, you need to make a contract with remote agents such as electric supply company, then this unit should be connected to Demand response enabling device (DRED). For further information, consult your dealer.

Demand response represents the automated alteration of an electrical product's normal mode of operation in response to an initiating signal originating from or defined by a remote agent.

This unit supports 3 Demand Response Modes (DRMs).

DRM	Description of operation in this mode	Operation indicator lamp ☀ Lighted ○ Not lighted
DRM 1	Compressor off The air conditioner does not perform cooling operation during the demand response event.	<p>Upper lamp is lighted.</p> <p>☀</p> <p>Lower lamp blinks.</p>
DRM 2	The air conditioner continues to perform cooling operation during the demand response event, but the electrical energy consumed by the air conditioner in a half hour period is not more than 50% of the total electrical energy that would be consumed if operating at the rated capacity in a half hour period.	
DRM 3	The air conditioner continues to perform cooling operation during the demand response event, but the electrical energy consumed by the air conditioner in a half hour period is not more than 75% of the total electrical energy that would be consumed if operating at the rated capacity in a half hour period.	

Note:

- DRM is automatically activated or released according to the signals from DRED. DRM cannot be invalidated or changed manually.
- You might feel this unit does not sufficiently perform cooling operation during DRM.
- Operation settings can be changed as usual with the remote controller during DRM. However, you might not feel cool or warm enough as DRM is prioritized.

EMERGENCY OPERATION

When the remote controller cannot be used...

Emergency operation can be activated by pressing the emergency operation switch (E.O. SW) on the indoor unit.

Each time the E.O. SW is pressed, the operation changes in the following order:

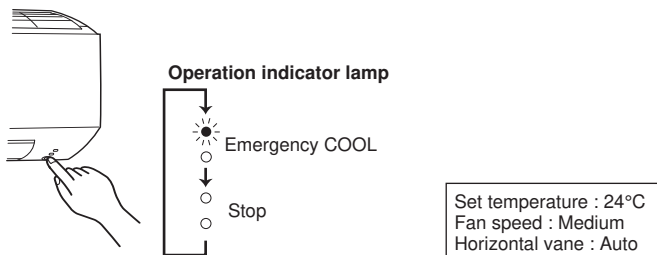

Note:

The first 30 minutes of operation is test run. Temperature control does not work, and fan speed is set to High.

AUTO RESTART FUNCTION

If a power failure occurs or the main power is turned off during operation, "Auto restart function" automatically starts operation in the same mode as the one set with the remote controller just before the shutoff of the main power. When timer is set, timer setting is cancelled and the unit starts operation when power is resumed.

If you do not want to use this function, please consult the service representative because the setting of the unit needs to be changed.

CLEANING

Instructions:

- Switch off the power supply or turn off the breaker before cleaning.
- Be careful not to touch the metal parts with your hands.
- Do not use benzine, thinner, polishing powder, or insecticide.
- When dirt stands out, wash it with kitchen neutral detergent diluted with lukewarm water to the specified concentration, then wipe off the detergent with a damp towel.
- Do not use a scrubbing brush, a hard sponge, or the like.
- Do not soak or rinse the horizontal vane.
- Do not use water hotter than 50°C.
- Do not expose parts to direct sunlight, heat, or fire to dry.
- Do not apply excessive force on the fan as it may cause cracks or breakage.

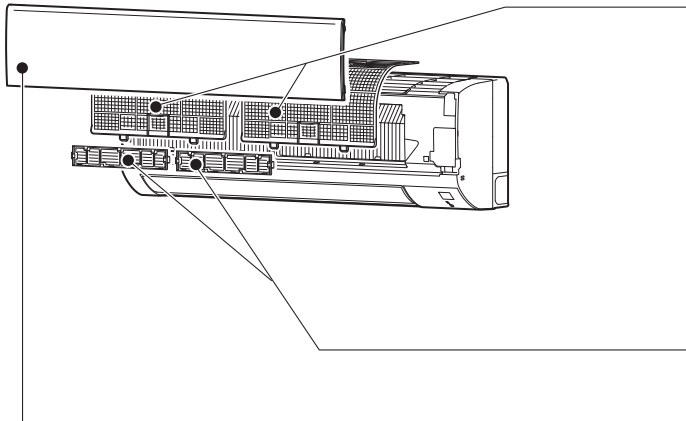

Front panel

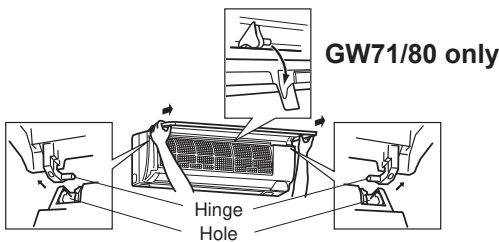

1. Lift the front panel until a "click" is heard.
2. Hold the hinges and pull to remove as shown in the above illustration.
 - Wipe with a soft dry cloth or rinse it with water.
 - Do not soak it in water for more than two hours.
 - Dry it well in shade.
3. Install the front panel by following the removal procedure in reverse. Close the front panel securely and press the positions indicated by the arrows.

<GW25/35/42/50/60>



<GW71/80>

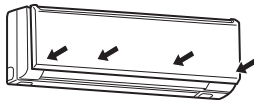

Air filter (Nano platinum filter)

- **Clean every 2 weeks**
- Remove dirt by a vacuum cleaner, or rinse with water.
- After washing with water, dry it well in shade.

What is "Nano platinum filter"?

Nano platinum is a ceramic particle that includes a platinum nanoparticle. The particles are incorporated into the filter material, which results in providing semi-permanent antibacterial and deodorizing characteristics for the filter. Nano platinum surpasses the catechin (a bioflavonoid that is found in green tea) in performance. Nano platinum filter uses this compound not only to improve air quality but also to eliminate bacteria and viruses. This air filter has a semi-permanent lasting effect even after washing it with water.

Air cleaning filter (Anti-Allergy Enzyme Filter, option)

- Every 3 months:**
- Remove dirt by a vacuum cleaner.
- When dirt cannot be removed by vacuum cleaning:**
- Soak the filter and its frame in lukewarm water before rinsing it.
 - After washing, dry it well in shade. Install all tabs of the air filter.

- Every year:**
- Replace it with a new air cleaning filter for best performance.
 - Parts Number
 GW25/35/42/50/60: **MAC-408FT-E**
 GW71/80: **MAC-2350FT-E**

<GW25/35/42/50/60>

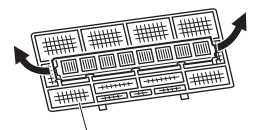

Pull to remove from the air filter

<GW71/80>

Filter guide

Push to install into the unit along the filter guide.

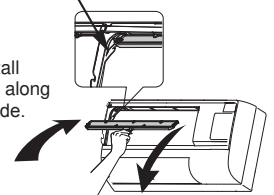

Pull to remove from the unit.

! Important

- **Clean the filters regularly for best performance and to reduce power consumption.**
- **Dirty filters cause condensation in the air conditioner which will contribute to the growth of fungi such as mold. It is therefore recommended to clean air filters every 2 weeks.**

WHEN YOU THINK THAT TROUBLE HAS OCCURRED

Even if these items are checked, when the unit does not recover from the trouble, stop using the air conditioner and consult your dealer.

Symptom	Explanation & Check points
Indoor Unit	
The unit cannot be operated.	<ul style="list-style-type: none"> Is the breaker turned on? Is the power supply plug connected? Is the ON timer set? Page 8
All LED lamps on the indoor unit are blinking.	<ul style="list-style-type: none"> Are the horizontal vanes installed correctly? Page 11
The horizontal vane does not move.	<ul style="list-style-type: none"> Are the horizontal vane and the vertical vane installed correctly? Is the fan guard deformed?
The unit cannot be operated for about 3 minutes when restarted.	<ul style="list-style-type: none"> This protects the unit according to instructions from the microprocessor. Please wait.
Mist is discharged from the air outlet of the indoor unit.	<ul style="list-style-type: none"> The cool air from the unit rapidly cools moisture in the air inside the room, and it turns into mist.
The swing operation of the HORIZONTAL VANE is suspended for a while, then restarted.	<ul style="list-style-type: none"> This is for the swing operation of the HORIZONTAL VANE to be performed normally.
The air flow direction changes during operation. The direction of the horizontal vane cannot be adjusted with the remote controller.	<ul style="list-style-type: none"> When the unit is operated in COOL or DRY mode, if the operation continues with air blowing down for 0.5 to 1 hour, the direction of the air flow is automatically set to upward position to prevent water from condensing and dripping.
The unit starts operation by itself when the main power is turned on, though it isn't operated with the remote controller.	<ul style="list-style-type: none"> These models are equipped with an auto restart function. When the main power is turned off without stopping the unit with the remote controller and is turned on again, the unit starts operation automatically in the same mode as the one set with the remote controller just before the shutoff of the main power. Refer to "AUTO RESTART FUNCTION". Page 10
The indoor unit discolors over time.	<ul style="list-style-type: none"> Although plastic turns yellow due to the influence of some factors such as ultraviolet light and temperature, this has no effect on the product functions.
Outdoor Unit	
The fan of the outdoor unit does not rotate even though the compressor is running. Even if the fan starts to rotate, it stops soon.	<ul style="list-style-type: none"> When the outside temperature is low during cooling operation, the fan operates intermittently to maintain sufficient cooling capacity.
Water leaks from the outdoor unit.	<ul style="list-style-type: none"> During COOL and DRY operations, pipe or pipe connecting sections are cooled and this causes water to condense.
Remote controller	
The display on the remote controller does not appear or it is dim. The indoor unit does not respond to the remote control signal.	<ul style="list-style-type: none"> Are the batteries exhausted? Page 4 Is the polarity (+, -) of the batteries correct? Page 4 Are any buttons on the remote controller of other electric appliances being pressed?

Symptom	Explanation & Check points
Does not cool	
The room cannot be cooled sufficiently.	<ul style="list-style-type: none"> Is the temperature setting appropriate? Page 5 Is the fan setting appropriate? Please change fan speed to High or Super High. Page 6 Are the filters clean? Page 11 Is the fan or heat exchanger of the indoor unit clean? Page 11 Are there any obstacles blocking the air inlet or outlet of the indoor or outdoor unit? Is a window or door open? When a ventilation fan or a gas cooker is used in a room, the cooling load increases, resulting in an insufficient cooling effect. When the outside temperature is high, the cooling effect may not be sufficient. It may take a certain time to reach the setting temperature or may not reach that depending on the size of the room, the ambient temperature, and the like.
Poor cooling performance.	<ul style="list-style-type: none"> Do you have an arrangement with your electric company for Demand Response?
Airflow	
The air from the indoor unit smells strange.	<ul style="list-style-type: none"> Are the filters clean? Page 11 Is the fan or heat exchanger of the indoor unit clean? Page 11 The unit may suck in an odor adhering to the wall, carpet, furniture, cloth, etc. and blow it out with the air.
Sound	
Cracking sound is heard.	<ul style="list-style-type: none"> This sound is generated by the expansion/contraction of the front panel, etc. due to change in temperature.
"Bubbling" sound is heard.	<ul style="list-style-type: none"> This sound is heard when the outside air is absorbed from the drain hose by turning on the range hood or the ventilation fan, making water flowing in the drain hose to spout out. This sound is also heard when the outside air blows into the drain hose in case the outside wind is strong.
Mechanical sound is heard from the indoor unit.	<ul style="list-style-type: none"> This is the switching sound in turning on/off the fan or the compressor.
The sound of water flowing is heard.	<ul style="list-style-type: none"> This is the sound of refrigerant or condensed water flowing in the unit.
Hissing sound is sometimes heard.	<ul style="list-style-type: none"> This is the sound when the flow of refrigerant inside the unit is switched.
Timer	
Weekly timer does not operate according to settings.	<ul style="list-style-type: none"> Is the ON/OFF timer set? Page 8, 9 Transmit the setting information of the weekly timer to the indoor unit again. When the information is successfully received, a long beep will sound from the indoor unit. If information fails to be received, 3 short beeps will be heard. Ensure information is successfully received. Page 9 When a power failure occurs and the main power turns off, the indoor unit built-in clock will be incorrect. As a result, the weekly timer may not work normally. Be sure to place the remote controller where the signal can be received by the indoor unit. Page 3
The unit starts/stops the operation by itself.	<ul style="list-style-type: none"> Is the weekly timer set? Page 9

In the following cases, stop using the air conditioner and consult your dealer.

- When water leaks or drips from the indoor unit.
- When the left/upper operation indicator lamp blinks. (For Multi system, except for when the lamp of a multi unit blinks while the unit is on standby.)
- When the breaker trips frequently.
- The remote control signal is not received in a room where an electronic ON/OFF type fluorescent lamp (inverter-type fluorescent lamp, etc.) is used.
- Operation of the air conditioner interferes with radio or TV reception. An amplifier may be required for the affected device.
- When an abnormal sound is heard.
- When any refrigerant leakage is found.

WHEN THE AIR CONDITIONER IS NOT GOING TO BE USED FOR A LONG TIME

- 1 Operate by COOL mode with the highest temperature set or FAN mode for 3 to 4 hours. **Page 5**
 - This dries the inside of the unit.
 - Moisture in the air conditioner contributes to growth of fungi, such as mold.
- 2 Press  to stop the operation.
- 3 Turn off the breaker and/or disconnect the power supply plug.
- 4 Remove all batteries from the remote controller.

When using the air conditioner again:

- 1 Clean the air filter. **Page 11**
- 2 Check that the air inlet and outlet of the indoor and outdoor units are not blocked.
- 3 Check that the earth is connected correctly.
- 4 Refer to the "PREPARATION BEFORE OPERATION", and follow the instructions. **Page 4**

INSTALLATION PLACE AND ELECTRICAL WORK

Installation place

Avoid installing the air conditioner in the following places.

- Where there is much machine oil.
- Salty places such as the seaside.
- Where sulfide gas is generated such as hot spring, sewage, waste water.
- Where oil is splashed or where the area is filled with oily smoke (such as cooking areas and factories, in which the properties of plastic could be changed and damaged).
- Where there is high-frequency or wireless equipment.
- Where the air from the outdoor unit air outlet is blocked.
- Where the operation sound or air from the outdoor unit bothers the house next door.
- The mounting height of indoor unit 1.8 m to 2.3 m is recommended. If it is impossible, please consult your dealer.
- Do not operate the air conditioner during interior construction and finishing work, or while waxing the floor. Before operating the air conditioner, ventilate the room well after such work is performed. Otherwise, it may cause volatile elements to adhere inside the air conditioner, resulting in water leakage or scattering of dew.
- The indoor unit must be installed in rooms which exceed the floor space specified. Please consult your dealer.

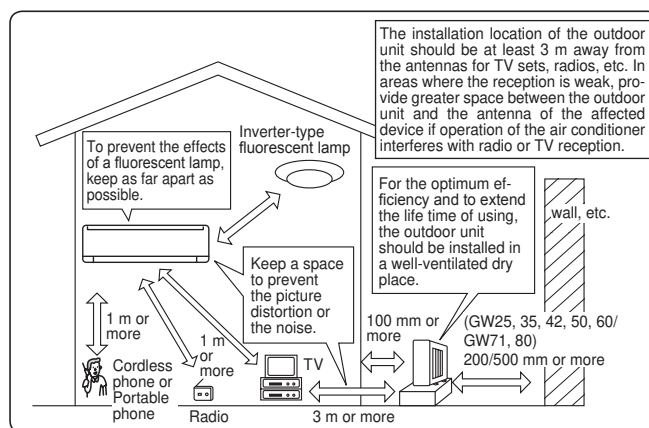

Electrical work

- Provide an exclusive circuit for the power supply of the air conditioner.
- Be sure to observe the breaker capacity.

If you have any questions, consult your dealer.

SPECIFICATIONS

Guaranteed operating range

		Indoor	Outdoor
Cooling	Upper limit	32°C DB 23°C WB	46°C DB —
	Lower limit	21°C DB 15°C WB	21°C DB —

DB : Dry Bulb
WB : Wet Bulb

mitsubishi MITSUBISHI ELECTRIC CORPORATION

HEAD OFFICE: TOKYO BUILDING, 2-7-3, MARUNOUCHI, CHIYODA-KU, TOKYO 100-8310, JAPAN

DG79A01WH01

