

# Washing Machine

# User manual

---

WF9\*F09C\*\* / WF9\*F11C\*\*

---

**SAMSUNG**

# Contents

---

<b>Safety information</b>	<b>4</b>
What you need to know about the safety instructions	4
Important safety symbols	4
Important safety precautions	5
Critical installation warnings	6
Installation cautions	8
Critical usage warnings	8
Usage cautions	9
Critical cleaning warnings	12
Instructions about the WEEE	13
Ecodesign	13
INFORMATION PURSUANT TO ART. 13 LAW DECREE n. 123/2023 (Applicable for Italia only)	14
<b>Installation</b>	<b>15</b>
What's included	15
Installation requirements	17
Step-by-step installation	19
<b>Before you start</b>	<b>28</b>
Initial setup	28
Run Calibration (recommended)	28
Laundry guidelines	29
Detergent recommendation	32
Detergent drawer guidelines	33
<b>Operations</b>	<b>37</b>
Control panel	37
Operating a cycle	39
Cycle overview	40
Settings	42
Special features	48
SmartThings	49
Open Source Announcement	50

---

<b>Maintenance</b>	<b>51</b>
Product Care	51
Drum clean+	51
Emergency drain	52
Cleaning	53
Defrosting your washing machine	57
Care against an extended time of disuse	57
<b>Troubleshooting</b>	<b>58</b>
Checkpoints	58
Information codes	62
<b>Specifications</b>	<b>64</b>
Fabric care chart	64
Protecting the environment	66
Spare parts guarante	66
Standby power consumption	66
Specification sheet	67
<b>Contact information</b>	<b>69</b>
QUESTIONS OR COMMENTS?	69

# Safety information

---

Congratulations on your new Samsung washing machine. This manual contains important information on the installation, use and care of your appliance. Please take some time to read this manual to take full advantage of your washing machine's many benefits and features.

## What you need to know about the safety instructions

---

Please read this manual thoroughly to ensure that you know how to safely and efficiently operate the extensive features and functions of your new appliance. Please store the manual in a safe location close to the appliance for future reference. Use this appliance only for its intended purpose as described in this instruction manual.

Warnings and Important Safety Instructions in this manual do not cover all possible conditions and situations that may occur. It is your responsibility to use common sense, caution and care when installing, maintaining and operating your washing machine.

Because the following operating instructions cover various models, the characteristics of your washing machine may differ slightly from those described in this manual and not all warning signs may be applicable. If you have any questions or concerns, contact your nearest service centre or find help and information online at [www.samsung.com](http://www.samsung.com).

## Important safety symbols

---

What the icons and signs in this user manual mean:

### **WARNING**

Hazards or unsafe practices that may result in **severe personal injury, death and/or property damage.**

### **CAUTION**

Hazards or unsafe practices that may result in **personal injury and/or property damage.**

### **Read the instructions**

After reading this manual, store it in a safe place for future reference.  
Read all instructions before using the appliance.

### **NOTE**

Indicates that a risk of personal injury or material damage exists.

These warning signs are here to prevent injury to yourself and others.  
Please follow them explicitly.

As with any equipment that uses electricity and moving parts, potential hazards exist. To safely operate this appliance, familiarize yourself with its operation and exercise care when using it.

---

## Important safety precautions

---

**To reduce the risk of fire, electric shock, or injury to persons when using your appliance, follow basic precautions, including the following:**

1. This appliance is not to be used by persons (including children) with reduced physical, sensory or mental capabilities, or lack of experience and knowledge, unless they have been given supervision or instruction concerning use of the appliance by a person responsible for their safety.
2. **For use in Europe:** This appliance can be used by children aged from 8 years and above and persons with reduced physical, sensory or mental capabilities or lack of experience and knowledge if they have been given supervision or instruction concerning use of the appliance in a safe way and understand the hazards involved. Children shall not play with the appliance. Cleaning and user maintenance shall not be made by children without supervision.
3. Children should be supervised to ensure that they do not play with the appliance.
4. If the supply cord is damaged, it must be replaced by the manufacturer, its service agent or similarly qualified persons in order to avoid a hazard.
5. **CAUTION:** In order to avoid a hazard due to inadvertent resetting of the thermal cut-out, this appliance must not be supplied through an external switching device, such as a timer, or connected to a circuit that is regularly switched on and off by the utility.

# Safety information

---

6. The new hose-sets supplied with the appliance are to be used and old hose-sets should not be reused.
7. This appliance is intended to be used in household only and it is not intended to be used such as:
  - staff kitchen areas in shops, offices and other working environments;
  - farm houses;
  - by clients in hotels, motels and other residential type environments;
  - bed and breakfast type environments;
  - areas for communal use in blocks of flats or in launderettes.
8. For appliances with ventilation openings in the base, a carpet must not obstruct the openings.
9. **For use in Europe:** Children of less than 3 years should be kept away unless continuously supervised.

## Critical installation warnings

---

### WARNING

The installation of this appliance must be performed by a qualified technician or service company.

- Failure to do so may result in electric shock, fire, an explosion, problems with the appliance, or injury.

The appliance is heavy, therefore take care when lifting it.

Plug the power cord firmly into a wall socket that meets local electrical specifications. Use the socket for this appliance only, and do not use an extension cord.

- Sharing a wall socket with other appliances using a power strip or extending the power cord may result in electric shock or fire.
- Ensure that the power voltage, frequency, and current are the same as those of the product specifications. Failure to do so may result in electric shock or fire.

---

Remove all foreign substances such as dust or water from the power plug terminals and contact points using a dry cloth on a regular basis.

- Unplug the power plug and clean it with a dry cloth.
- Failure to do so may result in electric shock or fire.

Plug the power plug into the wall socket so that the cord is running towards the floor.

- If you plug the power plug into the socket in the opposite direction, the electric wires within the cable may be damaged and this may result in electric shock or fire.

Keep all packaging materials out of the reach of children as these may be dangerous.

- If a child places a bag over its head, it may suffocate.

When the appliance, power plug or power cord is damaged, contact your nearest service centre.

This appliance must be properly grounded.

Do not ground the appliance to a gas pipe, plastic water pipe, or telephone line.

- This may result in electric shock, fire, an explosion, or problems with the appliance.
- Never plug the power cord into a socket that is not grounded correctly and make sure that it is in accordance with local and national regulations.

Do not install this appliance near a heater or any inflammable material.

Do not install this appliance in a humid, oily or dusty location, or in a location exposed to direct sunlight or water (rain drops).

Do not install this appliance in a location exposed to low temperatures.

- Frost may cause the tubes to burst.

Do not install this appliance in a location where gas may leak.

- This may result in electric shock or fire.

Do not use an electric transformer.

- This may result in electric shock or fire.

Do not use a damaged power plug, damaged power cord, or loose wall socket.

- This may result in electric shock or fire.

Do not pull or excessively bend the power cord.

Do not twist or tie the power cord.

Do not hook the power cord over a metal object, place a heavy object on the power cord, insert the power cord between objects, or push the power cord into the space behind the appliance.

- This may result in electric shock or fire.

Do not pull the power cord when unplugging the power plug.

- Unplug the power plug by holding the plug.
- Failure to do so may result in electric shock or fire.

This appliance should be positioned so that the power plug, the water supply taps, and the drain pipes are accessible.

# Safety information

---

Following the repair by a non-authorized service provider, self-repair or non-professional repair of the product, Samsung is not liable for any damage to the product, any injury or any other product safety issue caused by any attempt to repair the product which does not carefully follow these repair and maintenance instructions. Any damage to the product caused by an attempt to repair the product by any person other than a Samsung certified service provider will not be covered by the warranty.

## Installation cautions

---

### CAUTION

This appliance should be positioned in such a way that the power plug is easily accessible.

- Failure to do so may result in electric shock or fire due to electric leakage.

Install your appliance on a solid, level floor that can support its weight.

- Failure to do so may result in abnormal vibrations, movement, noise, or problems with the appliance.

## Critical usage warnings

---

### WARNING

If the appliance is flooded, turn off the water & power supplies immediately and contact your nearest service centre.

- Do not touch the power plug with wet hands.
- Failure to do so may result in electric shock.

If the appliance generates a strange noise, a burning smell, or smoke, unplug the power cord immediately and contact your nearest service centre.

- Failure to do so may result in electric shock or fire.

In the event of a gas leak (such as propane gas, LP gas, etc.), ventilate immediately without touching the power plug. Do not touch the appliance or power cord.

- Do not use a ventilating fan.
- A spark may result in an explosion or fire.

Remove the washing machine door lever before disposing the appliance.

- If trapped inside the appliance, children may suffocate to death.

Make sure to remove the packaging (sponge, styrofoam) attached to the bottom of the washing machine before using it.

Do not wash items contaminated with gasoline, kerosene, benzene, paint thinner, alcohol or other inflammable or explosive substances.

- This may result in electric shock, fire, or an explosion.

---

Do not open the washing machine door by force while it is operating (high-temperature washing/drying/spinning).

- Water flowing out of the washing machine may result in burns or cause the floor to be slippery. This may result in injury.
- Opening the door by force may result in damage to the appliance or injury.

Do not touch the power plug with wet hands.

- This may result in electric shock.

Do not turn the appliance off by unplugging the power cord while an operation is in progress.

- Plugging the power cord into the wall socket again may cause a spark and result in electric shock or fire.

Do not let children climb in or onto the appliance.

- This may result in electric shock, burns or injury.

Do not insert your hand or a metal object under the washing machine while it is operating.

- This may result in injury.

Do not unplug the appliance by pulling the power cord. Always grip the plug firmly and pull it straight out of the outlet.

- Damage to the power cord may cause a short-circuit, fire and/or electric shock.

Do not attempt to repair, disassemble, or modify the appliance yourself.

- Do not use a fuse (such as copper, steel wire, etc.) other than a standard fuse.
- When the appliance needs to be repaired or reinstalled, contact your nearest service centre.
- Failure to do so may result in electric shock, fire, problems with the appliance, or injury.

If the water supply hose comes loose from the water tap and floods the appliance, unplug the power cord.

- Failure to do so may result in electric shock or fire.

Unplug the power cord when the appliance is not being used for long periods of time or during a thunder or lightning storm.

- Failure to do so may result in electric shock or fire.

If any foreign substance enters into the appliance, unplug the power cord and contact your nearest Samsung Customer Service.

- This may result in electric shock or fire.

Keep your pets away from the appliance to prevent them from chewing any parts of the Washing Machine, which may result in electric shock, fire, or injury.

## Usage cautions

---

### CAUTION

When the washing machine is contaminated by a foreign substance such as detergent, dirt, food waste, etc., unplug the power cord and clean the washing machine using a damp, soft cloth.

- Failure to do so may result in discolouration, deformation, damage, or rust.

# Safety information

---

The front glass may be broken by a strong impact. Take care when using the washing machine.

- If the glass is broken, it may result in injury.

Open the water tap slowly after a long period of non-use, water supply failure, or when reconnecting the water supply hose.

- The air pressure in the water supply hose or the water pipe may damage a part of the appliance or result in a water leak.

If a draining error occurs during an operation, check if there is a draining problem.

- If the washing machine is used when it is flooded because of a draining problem, it may result in electric shock or fire.

Insert the laundry into the washing machine completely so that the laundry does not get caught in the door.

- If laundry gets caught in the door, it may result in damage to the laundry or the washing machine, or result in a water leak.

Turn the water supply off when the washing machine is not being used.

- Ensure that the screws on the water supply hose connector are properly tightened.

Ensure that the rubber seal and front door glass are not contaminated by a foreign substance (e.g. waste, thread, hair, etc.).

- If a foreign substance is caught in the door or the door is not completely closed, it may cause a water leak.

Open the water tap and check if the water supply hose connector is firmly tightened and that there is no water leak before using the appliance.

- If the screws on the water supply hose connector are loose, it may result in a water leak.

The appliance you have purchased is designed for domestic use only.

Using the appliance for business purposes qualifies as an appliance misuse. In this case, the appliance will not be covered by the standard warranty provided by Samsung and no responsibility can be attributed to Samsung for malfunctions or damages resulting from such misuse.

Do not stand on the appliance or place objects (such as laundry, lighted candles, lighted cigarettes, dishes, chemicals, metal objects, etc.) on the appliance.

- This may result in electric shock, fire, problems with the appliance, or injury.

Do not spray volatile material such as insecticide onto the surface of the appliance.

- As well as being harmful to humans, this may result in electric shock, fire or problems with the appliance.

Do not place objects that generate electromagnetic fields near the washing machine.

- This may result in injury due to a malfunction.

Water drained during a high-temperature wash or drying cycle is hot. Do not touch the water.

- This may result in burns or injury.

---

Draining time may vary depending on the water temperature. If the water temperature is too high, the draining process starts after the water cools down.

Do not wash, spin, or dry water-proof seats, mats, or clothing (\*) unless your appliance has a special cycle for washing these items.

(\*): Woollen bedding, rain covers, fishing vests, ski pants, sleeping bags, diaper covers, sweat suits, and bicycle, motor cycle and car covers, etc.

- Do not wash thick or hard mats even if the washing machine mark is on the care label. This may result in injury or damage to the washing machine, walls, floor, or clothing due to abnormal vibrations.
- Do not wash throw rugs or doormats with rubber backing. The rubber backing may come off and stick to inside the drum, and this may result in malfunction such as a drainage error.

Do not operate the washing machine when the detergent drawer is removed.

- This may result in electric shock or injury due to a water leak.

Do not touch the insides of the drum during or just after drying as it is hot.

- This may result in burns.

The door glass becomes hot during washing and drying. Therefore, do not touch the door glass.

Also, do not allow children to play around the washing machine or touch the door glass.

- This may result in burns.

Do not insert your hand into the detergent drawer.

- This may result in injury as your hand may be caught by the detergent input device.

Remove the liquid detergent guide (applicable models only) when using powdered detergent.

- If not, water may leak through the front of the detergent drawer.

Do not place any objects (such as shoes, food waste, animals) other than laundry into the washing machine.

- This may result in damage to the washing machine, or injury and death in the case of pets due to the abnormal vibrations.

Do not press the buttons using sharp objects such as pins, knives, fingernails, etc.

- This may result in electric shock or injury.

Do not wash laundry contaminated by oils, creams or lotions usually found in skincare shops or massage clinics.

- This may cause the rubber seal to become deformed and result in a water leak.

Do not leave metal objects such as safety pins, hair pins or bleach in the drum for long periods of time.

- This may cause the drum to rust.
- If rust starts appearing on the surface of the drum, apply a (neutral) cleansing agent to the surface and use a sponge to clean it. Never use a metal brush.

Do not use dry cleaning detergent directly and do not wash, rinse, or spin laundry contaminated by dry cleaning detergent.

- This may result in spontaneous combustion or ignition due to the heat from the oxidation of the oil.

# Safety information

---

Do not use water from water cooling/heating devices.

- This may result in problems with the washing machine.

Do not use natural hand-washing soap for the washing machine.

- If it hardens and accumulates inside the washing machine, it may result in problems with the appliance, discolouration, rust, or bad odours.

Place socks and brassieres in a washing net and wash them with the other laundry.

Do not wash large laundry items such as bedding in the washing net.

- Failure to do so may result in injury due to abnormal vibrations.

Do not use hardened detergent.

- If it accumulates inside the washing machine, it may result in a water leak.

Make sure that the pockets of all the clothing items to be washed are empty.

- Hard, sharp objects such as coins, safety pins, nails, screws, or stones can cause extensive damage to the appliance.

Do not wash clothing with large buckles, buttons or other heavy metal objects.

Sort the laundry by colour on the basis of its colorfastness and select the recommended cycle, water temperature and additional functions.

- This may result in discolouration or fabric damage.

Take care that children's fingers are not caught in the door when you close it.

- Failure to do so may result in injury.

To prevent odours and mould, leave the door open after a wash cycle to allow the drum to dry.

To prevent limescale build up, leave the detergent drawer open after a wash cycle and dry inside it.

## Critical cleaning warnings

---

### WARNING

Do not clean the appliance by spraying water directly onto it.

Do not use a strong acidic cleaning agent.

Do not use benzene, thinner or alcohol to clean the appliance.

- This may result in discolouration, deformation, damage, electric shock or fire.

Before cleaning or performing maintenance, unplug the appliance from the wall socket.

- Failure to do so may result in electric shock or fire.

## Instructions about the WEEE

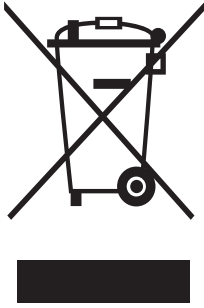

### Correct Disposal of This Product (Waste Electrical & Electronic Equipment)

(Applicable in countries with separate collection systems)

This marking on the product, accessories or literature indicates that the product and its electronic accessories (e.g. charger, headset, USB cable) should not be disposed of with other household waste at the end of their working life. To prevent possible harm to the environment or human health from uncontrolled waste disposal, please separate these items from other types of waste and recycle them responsibly to promote the sustainable reuse of material resources.

Household users should contact either the retailer where they purchased this product, or their local government office, for details of where and how they can take these items for environmentally safe recycling.

Business users should contact their supplier and check the terms and conditions of the purchase contract. This product and its electronic accessories should not be mixed with other commercial wastes for disposal.

For information on Samsung's environmental commitments and product regulatory obligations, e.g. REACH, visit our sustainability page available via [www.samsung.com](http://www.samsung.com)

### Product disposal in France



**FR**  
Cet appareil et ses accessoires se recyclent

REPRISE À LA LIVRAISON    OU    À DÉPOSER EN MAGASIN    OU    À DÉPOSER EN DÉCHÈTERIE

Points de collecte sur [www.quefairedemesdechets.fr](http://www.quefairedemesdechets.fr)  
Privilégiez la réparation ou le don de votre appareil !

**FR**  
ÉLÉMENTS D'EMBALLAGE + LIVRET + FEUILLE

Séparez les éléments avant de trier

## Ecodesign

For detailed instructions on installation and cleaning of the washing machine and eco design information (according to (EU)2019/2023), visit the Samsung website (<http://www.samsung.com>), go to Support > Support home, and then enter the model name.

# Safety information

---

## INFORMATION PURSUANT TO ART. 13 LAW DECREE n. 123/2023 (Applicable for Italia only)

---

Pursuant to article 13 D.L. n.123/2023, converted with amendments with Law n. 159/2023, Samsung Electronics Italia S.p.A. informs you that parental control applications are available in relation to this device.

We remind parents and those who exercise parental responsibility of the importance of activating and using parental control applications in order to increase the digital safety of minors, limiting and controlling access to digital content and the internet via this device. Activating parental control applications is free. For more information on parental control applications, we invite you to consult the websites of the Presidency of the Council of Ministers - Department of Family Policies and of the Communications Regulatory Authority: <https://famiglia.governo.it/it/politiche-e-attivita/famiglia/parental-control/> and [www.agcom.it/parental-control](http://www.agcom.it/parental-control).

# Installation

Follow these instructions carefully to ensure proper installation of the washing machine and to prevent accidents when doing laundry.

## What's included

Make sure all the parts are included in the product package. If you have a problem with the washing machine or the parts, contact a local Samsung customer centre or the retailer.

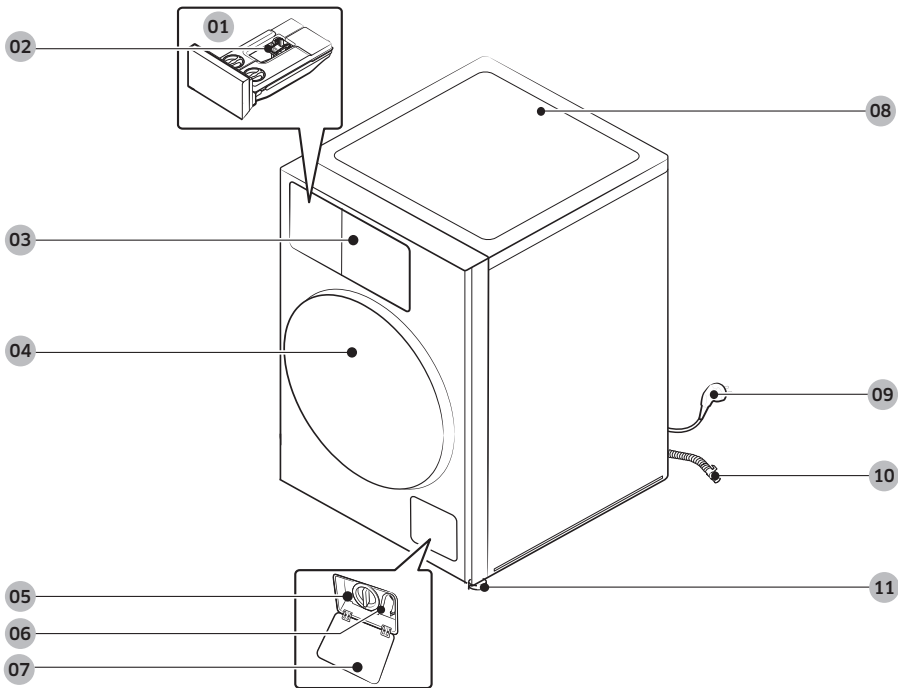

**01** Auto dispenser

**02** Release lever

**03** LCD panel

**04** Door

**05** Debris filter

**06** Emergency drain tube

**07** Filter cover

**08** Worktop

**09** Power plug

**10** Drain hose

**11** Levelling feet

\* The design of the drawer and/or the lever differs with the model.

# Installation



Spanner



Bolt caps

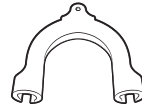

Hose guide



Cold water hose



Hot water hose

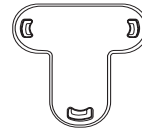

Cap Fixer  
(applicable models only)

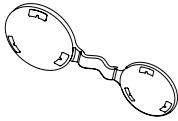

T-cap



Check valve

## Accessories (not supplied)

- Stacking kit:SKK-ZS\*
  - Staking kit is required to stack a dryer on a washing machine.

### NOTE

- Spanner: For removing the shipping bolts and levelling the washing machine.
- Bolt caps: For covering the holes after removing the shipping bolts. The provided number of bolt caps (3 to 6) depends on the model.
- Hose guide: For hanging the drain hose in the drainpipe or wash-basin.
- Cold/Hot water hose: For supplying water to the washing machine. (Hot water hoses is for applicable models only.)
- T-cap: Used to cover the T-hole on the box shell after removing the power cord.
- Check valve: Only supplied to some models.

---

## Installation requirements

---

### Electrical supply and grounding

- Use an individual branch circuit specific to the washing machine.

To ensure proper grounding, the washing machine comes with a power cord featuring a three-prong grounding plug for use in a properly installed and grounded outlet.

Check with a qualified electrician or service person if you are not sure about the grounding. Do not modify the provided plug. If it does not fit the outlet, call a qualified electrician to install a suitable outlet.

#### **WARNING**

- Do NOT use an extension cord.
- Use only the power cord that comes with the washing machine.
- Do NOT connect the ground wire to plastic plumbing, gas lines, or hot water pipes.
- Improperly connected grounding conductors may cause electric shock.
- Do not remove or modify the grounding pin of power cord to reduce the risk of electric hazard.
- Please use the additional grounding wire provided with this appliance if there is no hole for earth pin in power inlet socket.

### Water supply

A proper water pressure for this washing machine is between 50 kPa and 1000 kPa. Water pressure less than 50 kPa may cause the water valve to not close completely, or it may take longer to fill the drum, causing the washing machine to turn off. Water taps must be within 120 cm from the rear of the washing machine so that the provided inlet hoses reach the washing machine.

To reduce the risk of leaks:

- Make sure water taps are easily accessible.
- Turn off the taps when the washing machine is not in use.
- Check for any leaks at the water inlet hose fittings on a regular basis.

#### **CAUTION**

Before using the washing machine for the first time, check all connections at the water valve and taps for any leaks.

### Drain

Samsung recommends a standpipe 60-90 cm high. The drain hose must be connected through the hose clip to the standpipe, and the standpipe must fully cover the drain hose.

# Installation

## Flooring

For best performance, the washing machine must be installed on a solid floor. Wood floors may need to be reinforced to minimise vibration and/or unbalanced loads. Carpeting and soft tile surfaces do not resist vibration well and may cause the washing machine to move slightly during the spin cycle.

### CAUTION

Do NOT install the washing machine on a platform or a poorly supported structure.

## Water temperature

Do not install the washing machine in areas where water may freeze as the washing machine always retains some water in its water valves, pumps, and/or hoses. Frozen water left in the connection parts may cause damage to belts, the pump, and other components of the washing machine.

## Alcove installation

Minimum clearance for stable operation:

Sides	25 mm
Top	25 mm
Rear	50 mm
Front	550 mm

If both the washing machine and a dryer are installed in the same location, the front of the alcove must have at least a 550 mm unobstructed air opening. Your washing machine alone does not require a specific air opening.

---

## Step-by-step installation

---

### STEP 1 Select a location

---

Location requirements:

- Solid, level surface without carpeting or flooring that may obstruct ventilation
- Away from direct sunlight
- Adequate room for ventilation and wiring
- The ambient temperature is always higher than the freezing point (0 °C)
- Away from a heat source

#### NOTE

- To prevent excessive vibration while operating the washing machine, consider stability before anything else.
- Install your washing machine on a solid and level floor.
- Do not install your washing machine on soft floors or floor coverings.
- If you install your washing machine on a wood floor, install a water-resistance wooden panel (min 1.18 in. / 30 mm thick) to the floor. Also, we recommend installing your washing machine on the corner of the wood floor.

### STEP 2 Remove the shipping bolts

---

Unpack the product package and remove all shipping bolts.

#### NOTE

Number of shipping bolts may differ depending on the model.

#### WARNING

- Packaging materials can be dangerous to children. Dispose all packaging material (plastic bags, polystyrene, etc.) out of children's reach.
- To avoid injury, cover the holes with bolt caps after removing the shipping bolts. Do not move the washing machine without the shipping bolts in place. Assemble the shipping bolts before moving the washing machine to another location. Keep the shipping bolts in a safe place for future use.

# Installation

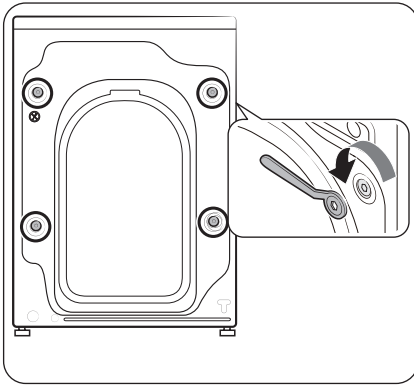

1. Locate the shipping bolts (marked with circle in the figure) on the rear side of the washing machine.
2. Using the supplied spanner, loosen all the shipping bolts by turning them anticlockwise.

 **NOTE**

You must keep the shipping bolts for future use.

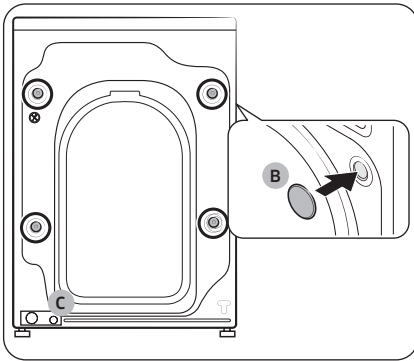

3. Insert the **bolt caps (B)** to the holes (marked with circle in the figure).

 **NOTE**

Insert the provided hole cap into position (C) in the figure.

### STEP 3 Adjust the levelling feet

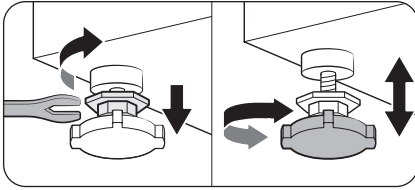

1. Gently slide the washing machine into position. Excessive force may damage the levelling feet.
2. Level the washing machine by manually adjusting the levelling feet.

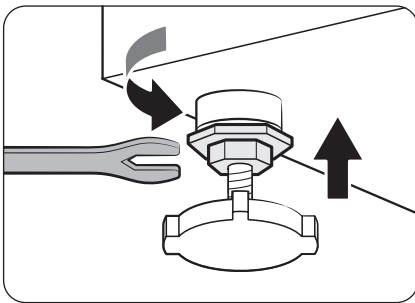

3. When levelling is complete, tighten the nuts using the spanner.

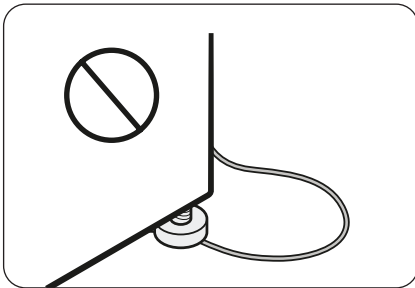

#### **⚠ CAUTION**

When installing the product make sure the levelling feet is not pressing the power cord.

#### **⚠ CAUTION**

Make sure all the levelling feet are seating on the floor surface to avoid the washing machine from moving or generating noise due to vibration. Then, check if the washing machine is rocking. If the washing machine is not rocking, tighten the nuts.

# Installation

## STEP 4 Connect the water hose

The provided water hose may differ depending on the model. Please follow the instruction according to the provided water hose.

### Connecting to a threaded water tap

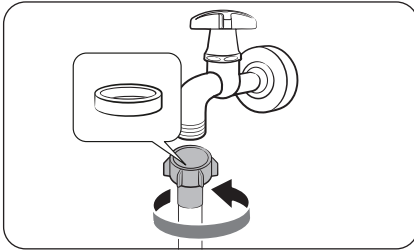

1. Connect the water hose to the water tap, and then turn it to the right to tighten.

#### ⚠ CAUTION

Before connecting the water hose, make sure there is a rubber washer in the hose connector. Do not use the hose if the washer is damaged or missing.

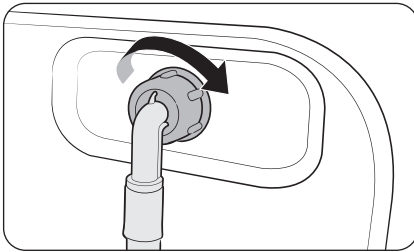

2. Connect the other end of the water hose to the inlet valve on the back of the washing machine, and then turn it to the right to tighten.

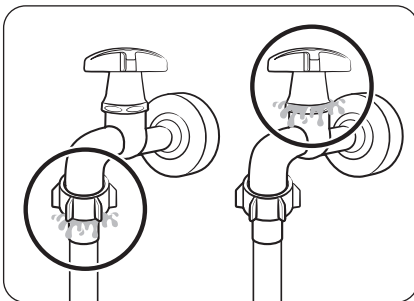

3. Slowly open the water tap and check if there are any leaks around the connection areas. If there are water leaks, repeat step 1 and 2.

#### ⚠ WARNING

If there is a water leak, stop operating the washing machine and disconnect it from the electrical supply. Then, contact a local Samsung service centre in case of a leak from the water hose, or contact a plumbing technician in case of a leak from the water tap. Otherwise, this may cause electric shock.

**⚠ CAUTION**

Do not stretch the water hose by force. If the hose is too short, replace the hose with a longer, high-pressure hose.

**Connecting to a non-threaded water tap**

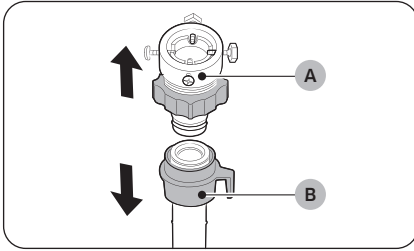

1. Remove the **adaptor (A)** from the water **hose (B)**.

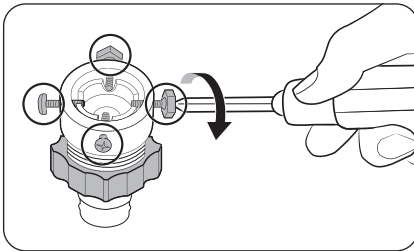

2. Use a Phillips screwdriver to loosen four screws on the adaptor.

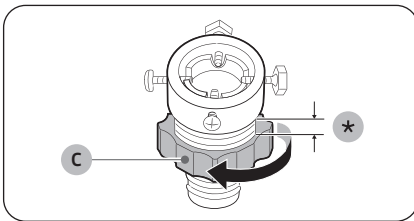

3. Hold the adaptor and turn **part (C)** in the arrow direction to loosen it by 5 mm (\*).

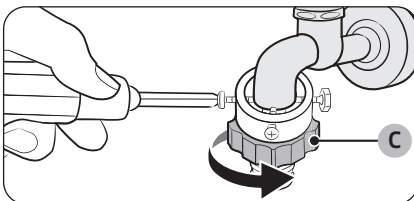

4. Insert the adaptor onto the water tap, and then tighten the screws while lifting the adaptor.
5. Turn **part (C)** in the arrow direction to tighten it.

# Installation

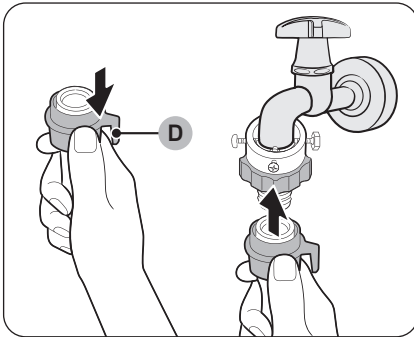

6. While pulling down **part (D)** on the water hose, connect the water hose to the adaptor. Then, release **part (D)**. The hose fits into the adaptor with a clicking sound.

7. To complete connecting the water hose, see 2 and 3 on the “**Connecting to a threaded water tap**” section.

## NOTE

- After connecting the water hose to the adaptor, pull the water hose down to check if it is connected properly.
- Use a popular type of water taps. If the tap is square-shaped or too big, remove the spacer ring before inserting the tap into the adaptor.

## For models with an additional hot water inlet:

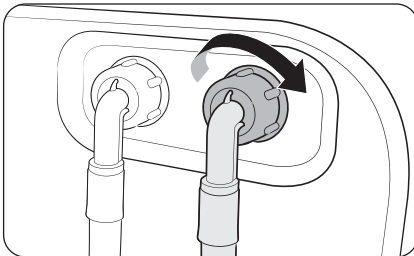

1. Connect the red end of the hot water hose to the hot water inlet on the back of the machine.
2. Connect the other end of the hot water hose to the hot water tap.

---

### Check valve (applicable models only)

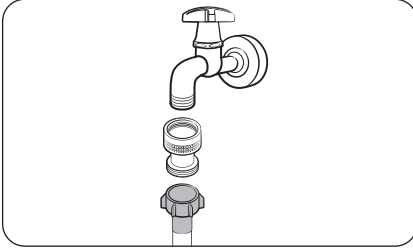

Before connecting the water hose to a water tap, connect the supplied check valve to the water tap and then connect the water hose.

### Aqua stop hose (applicable models only)

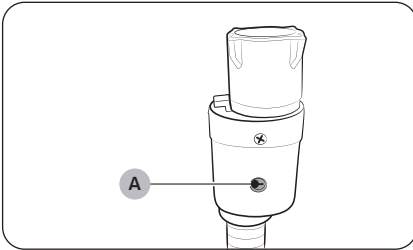

The aqua stop hose alerts users of a risk of water leaks. It senses the water flow and turns red on the centre **indicator (A)** in case of a leak.

### NOTE

The end of the aqua stop hose must be fitted to the water tap and not the machine.

# Installation

## STEP 5 Position the drain hose

The drain hose can be positioned in three ways:

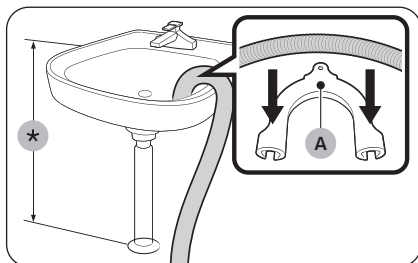

### Over the edge of a wash basin

The drain hose must be placed between 60 cm and 90 cm (\*) above from the floor. To keep the spout of the drain hose bent, use the supplied **plastic hose guide (A)**. Secure the guide to the wall using a hook to ensure stable drainage.

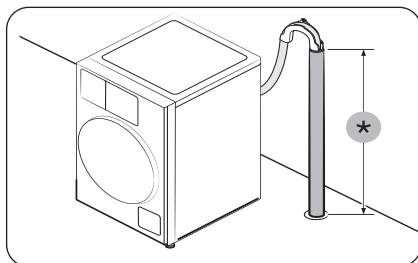

### In a drain pipe

The drain pipe should be between 60 cm and 90 cm high (\*). It is advisable to use a 65 cm high vertical pipe.

- To ensure the drain hose stays in position, use the plastic hose guide provided (see the figure).
- To prevent the siphoning of water flow during drainage, make sure to insert the drain hose 15 cm in the drain pipe.
- To prevent the drain hose from moving around, secure the hose guide to the wall.

Drain standpipe requirements:

- Minimum diameter of 5 cm
- Minimum carry-away capacity of 60 litres per minute

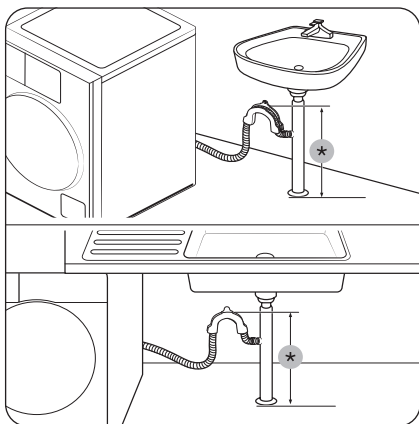

### In a sink drain pipe branch

The drain pipe branch must be above the sink siphon so that the end of the hose is at least 60 cm above the ground.

(\*) : 60 cm

#### ⚠ CAUTION

Remove the lid on the sink drain pipe branch before connecting the drain pipe to it.

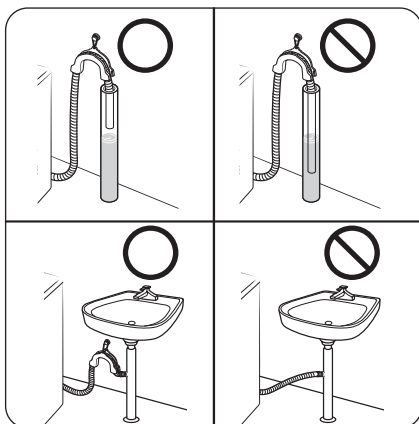

#### ⚠ CAUTION

Do not put the drain hose in places of stagnant water or ponding. The water may flow back to the washing machine.

## STEP 6 Power on

Plug the power cord into a wall socket that is correctly rated, grounded, and protected by a fuse or circuit breaker. Then, tap  to turn on the washing machine.

# Before you start

---

## Initial setup

---

- When you turn on the washing machine for the first time, the screen shows the initial setup process. Follow the on-screen instructions to complete it.
- Once you select a language, the language selection screen will not reappear. However, you must complete a wash cycle once to stop the tutorial screen from reappearing.
  - You can change the language from the Settings menu. On the Home screen, tap **Settings > General > Language** to change the language.
- The initial setup includes language selection and a brief tutorial.
- Tap **OK** to skip to the next screen.



### NOTE

If the initial setup screen does not appear during the first use of the product, it does not indicate a problem with the product. You can adjust the desired settings by selecting **Settings > General** from the Home screen, or reset the product to try running the initial setup process by selecting **Settings > General > Reset > Reset all settings**.

## Run Calibration (recommended)

---

Calibration ensures accurate weight detection by the Washing machine. Make sure the drum is empty before running calibration.

1. Tap  to turn the power on.
2. Tap  > **Washer > Calibration**.
3. Tap **Start Calibration** to start the calibration.

---

## Laundry guidelines

---

### STEP 1 Sort

---

#### Sort the laundry according to these criteria:

- Care Label: Sort the laundry into cottons, mixed fibres, synthetics, silks, wools, and rayon.
- colour: Separate whites from colours.
- Size: Mixing different sized items together in the drum improves the washing performance.
- Sensitivity: Wash delicate items separately, such as pure, new woollen items, curtains, and silk items. Check the labels on the items.

#### NOTE

Make sure to check the care label on the clothing, and sort them accordingly before starting the wash.

### STEP 2 Empty pockets

---

#### Empty all the pockets of your laundry items

- Metal objects such as coins, pins, and buckles on clothing may damage other laundry items as well as the drum.

#### Turn clothing with buttons and embroideries inside out

- If trousers or jacket zippers are open while washing, the drum may be damaged. Zippers should be closed and fixed with a string.
- Clothing with long strings may become entangled with other clothes. Make sure to tie the strings before starting the wash.

### STEP 3 Use a laundry net

---

- Brassieres (machine washable) must be placed in a laundry net. Metal parts of the brassieres may break through and tear other laundry items.
- Small, light clothing such as socks, gloves, stockings, and handkerchiefs may become caught around the door. Place them inside a fine laundry net.
- Do not wash the laundry net by itself without other laundry. This may cause abnormal vibrations that could move the washing machine and result in injury.

# Before you start

## STEP 4 Determine the load capacity

Do not overload the washing machine. Overloading may cause the washing machine to not wash properly.

### NOTE

When washing bedding or bedding covers, the wash time may be lengthened or the spin efficiency may be reduced. For bedding or bedding covers, the recommended maximum spin cycle speed is 800 rpm, and the load capacity is 2.0 kg or less.

### CAUTION

- Unbalanced laundry may reduce the spinning performance.
- Make sure the laundry is fully inserted in the drum and not caught in the door.
- Do not slam the door. Close the door gently. Otherwise, the door may not be closed properly.

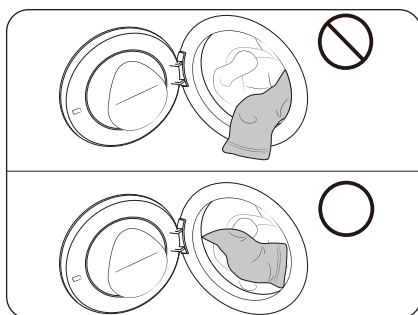

### CAUTION

Make sure the laundry is fully inserted into the drum and not caught in the door. Failure to do so may result in damage to the clothing and the diaphragm.

- Such damage is not covered under the product warranty.

## STEP 5 Apply a proper detergent type

The type of detergent depends on the type of fabric (cotton, synthetic, delicate items, wool), colour, wash temperature, and degree of soiling. Make sure to use the laundry detergent that is designed for automatic washing machines.

### NOTE

- Follow the detergent manufacturer's recommendations based on the weight of the laundry, the degree of soiling, and the hardness of the water in your local area. If you are not sure about the water hardness, contact a local water authority.
- Do not use detergent that tends to be hardened or solidified. This detergent may remain after the rinse cycle, blocking the drain outlet.

### CAUTION

When washing wool using the Wool cycle, use a detergent dedicated to wool items. If used with the Wool cycle, powder detergent may remain on the laundry and discolour the laundry.

## Laundry capsules

To get the best results from using laundry capsules, please follow these instructions.

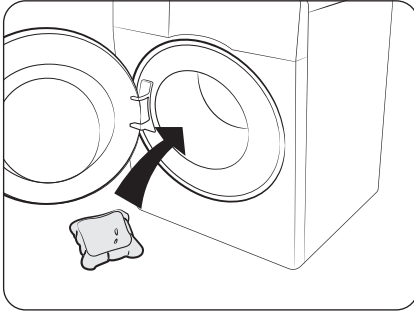

1. Put the capsule in the bottom of the empty drum towards the rear.

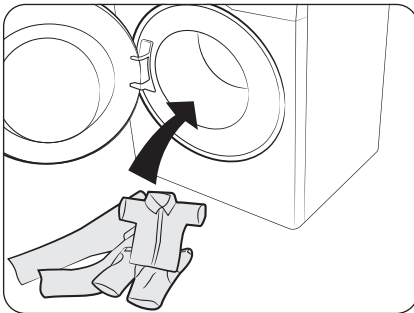

2. Put the laundry in the drum on top of the capsule.

### CAUTION

For cycles using cold water or cycles that complete in less than one hour, the capsule may not dissolve completely.

# Before you start

## Detergent recommendation

The recommendations apply to the temperature ranges given in the cycle chart

●	Recommended	▲	Liquid detergent only
-	Not recommended	△	Powder detergent only

Cycle	Detergent			Temp. (°C)
	Universal	Delicates and woollens	Specialist	
Eco 40-60	●	-	-	40-60
Cotton	●	-	-	Cold-90
AI Wash	●	-	-	40
SuperSpeed	●	-	-	Cold-40
Quick Wash 15'	▲	-	-	Cold-40
Mixed Load	●	-	-	Cold-40
Synthetics	●	-	-	Cold-60
Wool	-	●		Cold-40
Less Microfiber	●	-	-	Cold-40
Hygiene Steam	●	-	-	Cold-90
Colours	●	-	-	Cold-40
Towels	●	-	-	Cold-90
Outdoor	-	-	●	Cold-40
Bedding	●	-	-	Cold-40
Delicates	-	●	-	Cold-40
Activewear	-	-	●	Cold-40
Baby Care	●	-	●	Cold-90
Shirts	●	-	-	Cold-60
Denim	●	-	-	Cold-40
Cloudy Day	●	-	-	Cold-60
Silent Wash	●	-	-	Cold-40

## Detergent drawer guidelines

The automatic dispenser models provide a three-compartment dispenser: two compartments for auto-dispensing and another part for manual input. With the automatic dispensing option on, the washing machine dispenses an adequate amount of detergent or fabric softener for each load. See below for details:

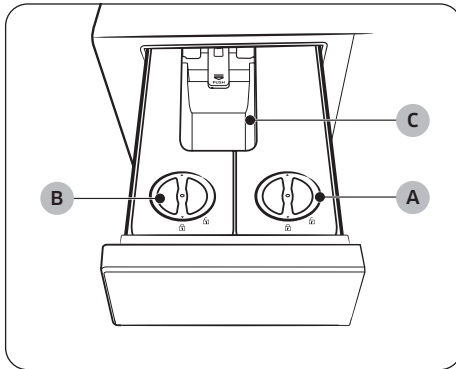

### A. Auto dispenser 1

- You can only use liquid detergent in this dispenser.

### B. Flex auto dispenser 2

- You can use liquid fabric softener or liquid detergent (**General, Specialty, Baby detergent**) in this dispenser.
- This dispenser is set to dispense fabric softener as a default. You may change the setting to use this dispenser to dispense detergent.
- Use only neutral detergent in this dispenser if you have set the **Detergent type** to **Specialty detergent**.
- Do not put powdered detergent.

### C. Manual detergent compartment

- You can use this compartment, to add the desired amount of liquid detergent, powder detergent, or fabric softener for a single wash cycle.
- To use the detergent in this compartment, make sure the auto-dispensing option is off.

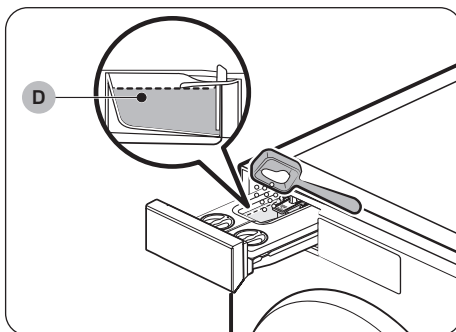

### ⚠ CAUTION

- Do not exceed the **max line (D)** when adding detergent into the manual detergent compartment. This may affect the washing results adversely.
- Do not use any cleaning agents for cleaning the drum. Chemical residue in the drum deteriorates the washing performance.

# Before you start

---

## CAUTION

- Do not operate the Washing machine without the dispensers in the detergent drawer.
  - A water leak may cause electric shock or injury.
- Do not use the following types of detergent in the drawer.
  - Tablet, capsule, ball, or net types.
- Do not use gel-type or viscous detergent/softener in the detergent drawer as they may not flow well.
  - Read the detergent/softener manufacturer's instructions before using them in the washing machine.
- Do not carry any removed compartment. Put the compartment back in place.
  - Otherwise, the compartment may shake and cause the content to spill out.
- Empty the compartments in the detergent drawer before moving the washing machine to prevent any content from spilling out on the floor.
- Do not use liquid or powdered chlorine bleach.
- Do not put or store cleaning agents such as detergent, bleach, or fabric softener on your Washing machine. Wipe up any spills immediately to prevent damage to the Washing machine, especially the finish and the LCD panel.

## NOTE

- The "Close dispenser" message appears if the detergent drawer is not completely closed. Close the detergent drawer before you start the washing machine.
- If message "Needs refill" appears on the display, refill the corresponding compartment.
- When using the Wool, Delicates, Activewear, Outdoor cycles, detergent or softener is not dispensed automatically. If detergent/softener is required, it must be dispensed manually.
- For special detergents or softeners (wools, baby clothes, etc.), please purchase an additional compartment and use the new compartment exclusively for the special detergent or softener.
- Push the compartment to the bottom to close it.
- If you feel the softener smell is weak, set the softener addition level to high.
- Do not exceed the Max Line when adding detergent and softener.
- Do not mix detergent and softener.
- Always keep the lid of the detergent/softener compartment tightly closed.
- Once you refill the detergent/softener compartment and the message does not disappear, turn the washing machine off and then on again, or open the detergent compartment for more than 3 seconds and then turn it off.
- The washing machine will start to detect the added detergent or softener.
- The detection time may vary depending on the type of detergent or softener.
- Moisture on the powder detergent drawer can cause the detergent to stick. Therefore, wipe off the moisture with a dry cloth before adding detergent.

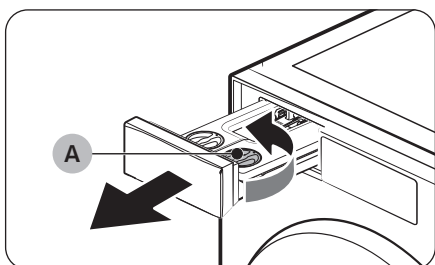

1. Gently press the detergent drawer to open.
2. Turn the **Auto dispenser 1 cap (A)** anticlockwise to open.

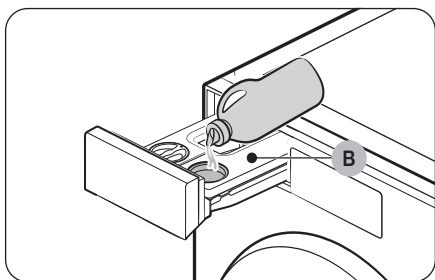

3. Apply an appropriate amount of detergent to the **Auto dispenser 1 cap (B)**.
  - After you finish, put the cover back and turn it clockwise to close.

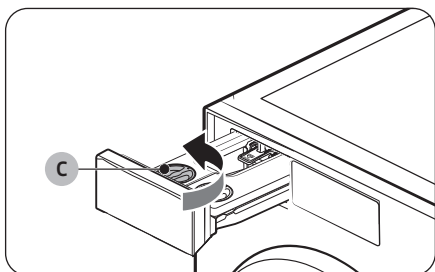

4. Turn the **Flex auto dispenser 2 cover (C)** anticlockwise to open.

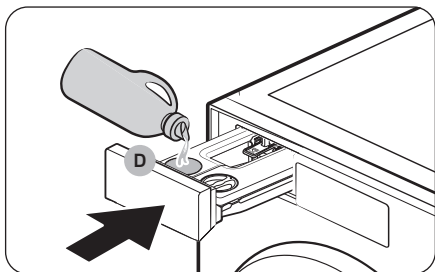

5. Apply an appropriate amount of Softener or detergent to the **Flex auto dispenser 2 (D)**.
  - After you finish, put the cover back and turn it clockwise to close.
6. Push the detergent drawer to close.
  - Push the detergent drawer all the way to the end.

# Before you start

## CAUTION

- Do not apply detergent/softener to the drawer without the detergent/softener compartment.
  - If you do, clean the drawer and then reinsert both compartments.
- Only use liquid detergent or softener in the auto dispenser. Do not use powdered detergent.
- Make sure both detergent/softener compartments are inserted completely.
  - If they are not, the washing machine may not start operating or fail to dispense washing agents.
- Clean the dispenser before refilling it with the same or a different type of detergent or softener.
- Do not leave detergent or softener in the auto dispenser for more than 6 weeks.
- Do not mix detergent with fabric softener in either dispenser.
- To prevent detergent or softener from hardening, leave the cap closed after filling the dispenser.
- Do not use any bleach that may cause corrosion and/or generate the gas.
- Do not turn any compartment upside down.
  - The content may spill.
- Do not press the outlet at the rear of either compartment while moving it.
  - The content may leak.
- Use caution when inputting detergent or fabric softener in the applicable compartment.
  - The content may spill.
- When removing the dispenser **1** or **2** to check the remaining content (upon an error message or before the message appears), the drawer may have content remaining or leaking from the bottom of the drawer.
- Make sure all the dispensers in the detergent drawer are empty before moving the washing machine.
- The input or refill level of the detergent or softener depends on the type or the remaining amount of detergent or softener.
- Applying detergent directly to the laundry cause discolouration. Apply detergent in the dispenser.
- Do not use hardened detergent or softener.

## Dispenser care

You can check the detergent type used in each dispenser.

## NOTE



On the Dispenser care screen, the current status of detergent and fabric softener is displayed and will alert you if any of the dispensers are running low. Follow the on-screen instructions to refill the detergent or fabric softener.

1. On the Home screen, tap **Dispenser care** to move to the Dispenser care screen.
2. Check the amount of detergent in each dispenser and fill the dispenser if the amount is low.
3. Tap  to move to the Home screen.

# Operations

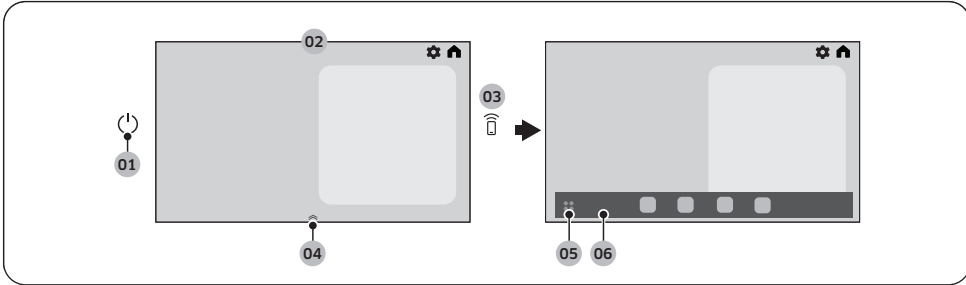









## Control panel



<b>01</b> Power 	Tap to turn the Washing machine on or off.
<b>02</b> Display	The display shows current cycle information and estimated time remaining, or an information message when a problem occurs.
<b>03</b> Smart Control 	Tap to activate or deactivate the Smart Control function. Tap and hold to enter pairing mode to connect to the SmartThings app. <ul style="list-style-type: none"> <li>When the Smart Control function is activated, you can control your washing machine remotely using the SmartThings app on your smartphone or tablet (Android or iOS).</li> </ul>
<b>04</b> App dock handler	Drag the App dock handler upward to open the App dock. <ul style="list-style-type: none"> <li>The App dock handler only appears on the Home screen.</li> </ul>
<b>05</b> App tray button	Tap to view all available apps. <ul style="list-style-type: none"> <li>Tap App tray to open App drawer. you can open the App drawer to quickly open each of the available apps.</li> </ul>
<b>06</b> App dock	App dock displays the icons to allow easier access to the frequently used apps.



# Operations

## Display icon descriptions

	<b>Home</b>	Tap to go to the Home screen.
	<b>Settings</b>	Tap to enter the Settings menu. <ul style="list-style-type: none"><li>For more information on <b>Settings</b>, see page 48.</li></ul>
	<b>Door Lock</b>	<ul style="list-style-type: none"><li>This icon indicates the door is locked and cannot be opened.</li><li>The door locks automatically during a cycle and this indicator turns on.</li><li>You can open the door when this icon disappears.</li></ul>
	<b>Smart Control</b>	<ul style="list-style-type: none"><li>This icon indicates that the Smart Control is on.</li></ul>
	<b>Microphone</b>	<ul style="list-style-type: none"><li>This icon indicates that the microphone is on.</li></ul>
	<b>Wi-Fi</b>	<ul style="list-style-type: none"><li>This icon indicates the signal strength when the Internet connection is active.</li></ul>
	<b>Lock</b>	<ul style="list-style-type: none"><li>This icon indicates that Child Lock is on.</li></ul>
	<b>Delay End</b>	You can set the Washing machine to finish your wash automatically at a later time. <ul style="list-style-type: none"><li>Tap Delay End at the bottom of the Cycle screen.</li><li>Set the desired end time, and then tap OK.</li><li>To cancel Delay End, tap Stop to restart the Washing machine.</li></ul>
	<b>Start</b>	You can start the operation.
	<b>Pause</b>	You can pause the operation. <ul style="list-style-type: none"><li>During the operation, tap the button to pause.</li></ul>

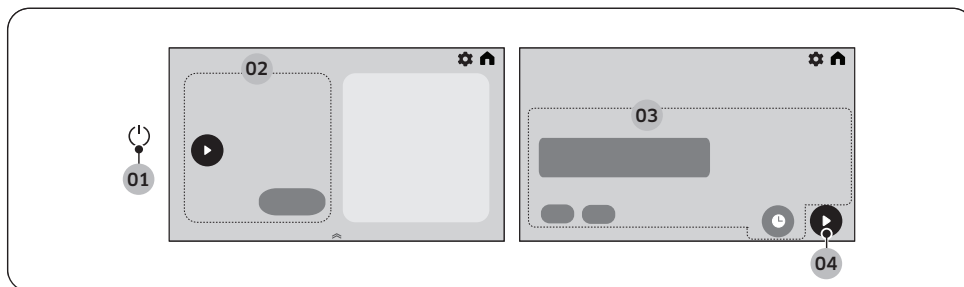
## Operating a cycle



1. Tap  to turn on the washing machine.
2. Select the desired cycle.
  - For more information on **Cycle overview**, see page 40.
3. Change the default cycle options.
  - For the washing process, tap > Select Detergent, Softener, Wash Temp, Rinse, Spin, Quick Drive, Pre Wash, Intensive or Bubble Soak to change the default cycle settings.
  - You can set the Delay End function.
  - Not all cycles have additional functions available.
4. Tap  to start the operation.
  - Once you set the cycle you want, the screen displays brief cycle descriptions and cycle duration. You can also check the cycle progress, remaining cycle time, and information codes.

# Operations

## Cycle overview

Cycle	Description	Max load (kg)
<b>Eco 40-60</b>	<ul style="list-style-type: none"> <li>For cleaning normally soiled cotton items which are declared to be washable at 40 °C or 60 °C, together in the same cycle. This cycle is used to assess the compliance with the EU Ecodesign legislation.</li> <li>This cycle is set as a default.</li> </ul>	Max
<b>Cotton</b>	<ul style="list-style-type: none"> <li>For cottons, bed linens, table linens, underwear, towels, or shirts. The washing time and the rinse count are automatically adjusted according to the load.</li> </ul>	Max
<b>AI Wash</b>	<ul style="list-style-type: none"> <li>Adjusts the amount of detergent and the cycle according to the load and the soil severity. This cycle is best used with the Auto Dispense function.</li> </ul>	Max
<b>Super Speed</b>	<ul style="list-style-type: none"> <li>Fast completion for everyday items such as underwear and shirts.</li> <li>The cycle time will differ depending on the water supply conditions, load, and type of laundry.</li> </ul>	5
<b>Quick Wash 15'</b>	<p>For lightly soiled items that you want to wash quickly.</p> <ul style="list-style-type: none"> <li>Use less than 20 g of detergent. Using more than 20 g of detergent may leave detergent residue.</li> <li>For liquid detergent, use a maximum of 20 ml of liquid detergent.</li> <li>Use the High or Extra High spin speed option if load is sensed not so dry at the end of this cycle.</li> </ul>	2
<b>Mixed Load</b>	<ul style="list-style-type: none"> <li>For mixed load consisting of cotton and synthetic.</li> </ul>	4
<b>Synthetics</b>	<ul style="list-style-type: none"> <li>For fabrics that are made of polyester(diolen, trevira), polyamide (perlon, nylon), or the like.</li> </ul>	4
<b>Wool</b>	<ul style="list-style-type: none"> <li>Specific for machine-washable wool.</li> <li>The Wool cycle features fine pulsating and soaking to protect the wool fibres from shrinkage/distortion.</li> <li>A neutral detergent is recommended.</li> </ul>	2
<b>Less Microfiber</b>	<ul style="list-style-type: none"> <li>Use this cycle to reduce the amount of microfibers generated during washing synthetic clothes.</li> </ul>	2

Cycle	Description	Max load (kg)
<b>Hygiene Steam</b>	<ul style="list-style-type: none"> <li>• Cotton and linen fabric which have been in direct contact with the skin, e.g. underwear.</li> <li>• For optimum hygiene results select a temperature of 60 °C or above.</li> <li>• Steam cycles feature allergy care and bacteria elimination (sterilize).</li> </ul>	4
<b>Colours</b>	<ul style="list-style-type: none"> <li>• Featuring additional rinses and reduced spinning to ensure that the laundry is washed gently and rinsed thoroughly.</li> </ul>	4
<b>Towels</b>	<ul style="list-style-type: none"> <li>• For bath towels, washcloths, and mats.</li> </ul>	4
<b>Outdoor</b>	<ul style="list-style-type: none"> <li>• For outdoor clothes, skiwear, and sportswear that are made of functional materials such as spandex, stretch, and microfibre.</li> </ul>	2
<b>Bedding</b>	<ul style="list-style-type: none"> <li>• For bed spreads, bed sheets, bedding covers, etc.</li> <li>• For best results, wash only 1 type of bedding.</li> </ul>	2
<b>Delicates</b>	<ul style="list-style-type: none"> <li>• For sheer fabrics, bras, lingerie (silk), and other handwash-only fabrics.</li> <li>• For best performance, use liquid detergent.</li> </ul>	2
<b>Activewear</b>	<ul style="list-style-type: none"> <li>• For exercise wear such as sports jerseys, training pants, shirts/tops and other performance clothing. This cycle provides effective soil removal with controlled drum rotation for special fabric care.</li> </ul>	2
<b>Baby Care</b>	<ul style="list-style-type: none"> <li>• Featuring a high-temperature wash and extra rinses to help remove the remaining detergent effectively.</li> </ul>	4
<b>Shirts</b>	<ul style="list-style-type: none"> <li>• For shirts, blouses that are made of cotton, synthetic fiber.</li> </ul>	2
<b>Denim</b>	<ul style="list-style-type: none"> <li>• A wash cycle with a higher water level and an extra rinse cycle that ensures that no detergent remains to mark your clothing.</li> </ul>	3
<b>Cloudy Day</b>	<ul style="list-style-type: none"> <li>• For optimum spin drying at high humid condition.</li> </ul>	Max
<b>Silent Wash</b>	<ul style="list-style-type: none"> <li>• For reducing operating noise and vibration.</li> </ul>	4
<b>Rinse+Spin</b>	<ul style="list-style-type: none"> <li>• Featuring an additional rinse process after applying fabric softener to the laundry.</li> </ul>	Max
<b>Drain/Spin</b>	<ul style="list-style-type: none"> <li>• For draining the water inside the drum and running an additional spin process to effectively remove moisture from laundry.</li> </ul>	Max

# Operations

Cycle	Description	Max load (kg)
Drum Clean+	<ul style="list-style-type: none"><li>• Cleans the drum by removing dirt and bacteria from it.</li><li>• Cleans the rubber door gasket by removing dirt from the gasket.</li><li>• Perform once every 40 washes with no detergent or bleach applied. Notification message appears after every 40 washes.</li><li>• Make sure the drum is empty.</li><li>• Do not use any cleaning agents for cleaning the drum.</li></ul>	-

## NOTE

- The power consumption and water consumption data displayed on the program completion page are for user reference only. Due to the different home environments and habits of each user, there may be differences from the test results under the standard laboratory environment.
- Loading the household washing machine or the household washer-dryer up to the capacity indicated by the manufacturer for the respective cycles will contribute to energy and water savings.
- The noise and remaining moisture content are influenced by the spinning speed: the higher the spinning speed in the spinning phase, the higher the noise and the lower the remaining moisture content.
- The most efficient cycle in terms of energy consumption are generally those that perform at lower temperatures and longer duration.

## Settings

### Using Settings

1. Tap .
2. Tap **General** or **Washer**.
3. Scroll through the screen to select the desired menu.
4. Change the settings or start the function.

## NOTE

- To return to the Home screen, tap  on the top left corner, or  on the top right corner of the screen.

## Settings menu description

### General

Options	Descriptions
<b>Samsung Account</b>	You can log in to your Samsung account or create a new Samsung account.
<b>Connections</b>	<p>You can turn the Wi-Fi on or off. You can also start the Smart Control function.</p> <ul style="list-style-type: none"> <li>• <b>Wi-Fi:</b> Tap to turn on or off the Wi-Fi. <ul style="list-style-type: none"> <li>- The Washing machine Wi-Fi is off as a factory default setting. However, the Washing machine Wi-Fi turns on automatically when you turn on the Washing machine for the first time. Then, the final Wi-Fi setting is maintained regardless of the Washing machine power status.</li> <li>- Once you turn on the Washing machine Wi-Fi and connect to a network, the Washing machine remains connected to the network even when you turn off the power.</li> <li>- The Wi-Fi indicates that the Washing machine is connected to the router through the Wi-Fi connection.</li> </ul> </li> <li>• <b>Easy connection:</b> You can easily install the SmartThings app using the displayed QR code on the screen. <ul style="list-style-type: none"> <li>- You can connect to the SmartThings app and control your Washing machine remotely.</li> </ul> </li> <li>• <b>Bluetooth:</b> You need to turn on the Bluetooth function of your phone, scan and pair. Once the devices are paired successfully, you can make calls or play music, and manage your laundry more conveniently.</li> </ul>
<b>Lock</b>	<p>You can lock the control of the Washing machine to prevent children or infants from accidentally starting or setting the Washing machine.</p> <ul style="list-style-type: none"> <li>• When Lock is enabled, the touch screen and the door become locked for safety.</li> <li>• You can Lock in any selected cycle.</li> <li>• Press and hold the Unlock button for 3 seconds to unlock.</li> </ul> <p> <b>NOTE</b></p> <ul style="list-style-type: none"> <li>• If you want to put additional items into the Washing machine while Lock is enabled, you must disable the Lock function first.</li> <li>• You cannot open the door after a wash cycle when the Lock is on. Disable the function first, and then open the door and take out the laundry.</li> </ul>

# Operations

Options	Descriptions
Sounds	<p>You can set the Sound mode, Sound theme, Volume, and Voice style.</p> <ul style="list-style-type: none"> <li>• <b>Sound mode:</b> You can set the desired Sound mode from Voice, Tone, and Mute. <ul style="list-style-type: none"> <li>- If you set the Sound mode to Mute, the alert sound will not be turned off for safety purposes.</li> </ul> </li> <li>• <b>Sound theme:</b> You can select the desired Sound theme. Tap a theme once to preview the sound.</li> <li>• <b>Volume:</b> You can adjust the volume for system and media sounds. <ul style="list-style-type: none"> <li>- Sound mode will automatically change to <b>Voice</b> if you adjust the volume while the Sound mode is set to <b>Mute</b>.</li> </ul> </li> <li>• <b>Voice style:</b> You can select the desired Voice style. Tap a style once to preview the sound.</li> </ul>
Home device notifications	You can turn on or off the notifications for your home devices registered on the SmartThings app.
Display	You can set the Brightness and Font size.
Avatar	You can learn device tutorials, receive various notifications and get more services by interacting with the avatar of your choice.
Bixby	<p>You can set the Voice wake-up and Sound feedback options.</p> <p> <b>NOTE</b></p> <ul style="list-style-type: none"> <li>• The microphone for voice recognition is built into the Washing machine worktop. <ul style="list-style-type: none"> <li>- The best way to use the voice recognition function is to stand within 3 feet (1 meter) of the Washing machine, reduce any background noise, and speak loudly and clearly at a steady pace toward the built-in microphone.</li> </ul> </li> <li>• The voice recognition function may not work if you stand more than 3 feet (1 meter) away or if you speak too softly.</li> </ul>
Microphone	You can enable or disable the use of the microphone.
App lock	You can enable or disable app locking. When enabled, the selected App will not be available.
Language	You can change the system language.
Date and time	You can set the time and date automatically or manually and set the desired time format.
Liquid units	You can select the liquid units.

Options	Descriptions
Accessibility	<p>You can set the Voice guide and Visibility enhancements settings.</p> <ul style="list-style-type: none"> <li>• <b>Voice guide:</b> Enable this feature to receive voice feedback from your Washing machine. <ul style="list-style-type: none"> <li>- Once the Voice guide is turned on, it will remain on even if you restart the device. You can pause it using the Accessibility button in the upper left corner of the home screen, or stop it completely by pressing the Off button shown below. If you need to turn off the Voice guide icon, turn off the Voice guide function in the Settings.</li> <li>- How to use: You can switch items by swiping the screen left and right. After hearing the voice broadcast reminder of the item, double-click the screen to activate the item.</li> </ul> </li> <li>• <b>Visibility enhancements:</b> You can change the High contrast and Text size settings to enhance the visibility.</li> </ul>
Software update	<p>You can download and install the latest version of the software. Download begins automatically when the Washing machine is connected to Wi-Fi.</p>
Support	<p>You can check the user guide or start the remote support service.</p> <ul style="list-style-type: none"> <li>• Get remote support for all your needs related to your appliance.</li> </ul>
Reset	<p>You can reset network settings or reset all settings.</p> <ul style="list-style-type: none"> <li>• <b>Reset network settings:</b> <ul style="list-style-type: none"> <li>- This will reset the Wi-Fi and SmartThings connection settings.</li> </ul> </li> <li>• <b>Reset all settings:</b> <ul style="list-style-type: none"> <li>- This will reset all the settings, including network settings and personal data.</li> <li>- Your Washing machine resets to the factory setting.</li> </ul> </li> <li>• <b>Restart:</b> Restart the device.</li> </ul>
About device	<p>You can check the information of the Washing machine such as Status and Legal information.</p>

# Operations

## Washer

Options	Descriptions
<p><b>Auto dispensers</b></p>	<p>You can select the dispenser mode and set the detergent type, concentration, and amount setting. The Washing Machine automatically dispenses an adequate amount of detergent for the selected cycle.</p> <p><b>Auto dispenser</b></p> <p>You can select the Dispenser mode. The default setting is General detergent.</p> <ul style="list-style-type: none"> <li>• <b>Detergent type:</b> You can only select General detergent.</li> <li>• <b>Concentration:</b> You can change the concentration level.             <ul style="list-style-type: none"> <li>- 1x &gt; 2x &gt; 3x</li> <li>- The default setting is 1x.</li> </ul> </li> <li>• <b>Amount:</b> You can select the amount of the detergent to be dispensed during each wash cycle.             <ul style="list-style-type: none"> <li>- Low &gt; Medium &gt; High</li> <li>- The default setting is Medium.</li> </ul> </li> </ul> <p><b>Flex auto dispenser</b></p> <p>The flex auto dispenser can be set to dispense softener or regular detergent. You must run the pump clean function before switching between Softener and detergent (General detergent, Specialty detergent or Baby detergent).</p> <ul style="list-style-type: none"> <li>• <b>Detergent type:</b> You can set this to dispense Softener or General detergent, Specialty detergent, Baby detergent. The default setting is Softener.</li> <li>• <b>Concentration:</b> You can change the concentration level.             <ul style="list-style-type: none"> <li>- 1x &gt; 2x &gt; 3x</li> <li>- The default setting is 1x.</li> </ul> </li> <li>• <b>Amount:</b> You can select the amount of detergent/softener to put in each wash cycle.             <ul style="list-style-type: none"> <li>- Low &gt; Medium &gt; High</li> <li>- The default setting is Medium.</li> </ul> </li> </ul> <p><b>NOTE</b></p> <ul style="list-style-type: none"> <li>• You can enable and disable automatic detergent dispensing and set the detergent amount to be dispensed for each cycle. You must put detergent manually if you disable the automatic detergent dispensing.</li> <li>• If you have set the flex auto dispenser to General detergent, the washing machine cannot dispense softener during the wash cycle. To use softener, add it to the drum or manual dispenser after the program is completed and run the Rinse + Spin program.</li> </ul>

Options	Descriptions
Auto dispensers	<ul style="list-style-type: none"> <li>If you have set the dual-purpose automatic dispenser to normal detergent, you must put special detergent (for wool, baby clothes, etc.) in the drum or manual detergent dispenser to use special detergent.</li> <li>If you have set the dispenser 2 to Specialty detergent, Wool/ Delicates/Outdoor/Activewear cycle will be automatically dispensed from dispenser 2.</li> <li>If you have set the dispenser 2 to Baby detergent, Baby care cycle will be automatically dispensed from dispenser 2.</li> </ul>
Pump clean	<p>You can use this function to clean detergent or softener residue buildup in the pump.</p> <p>Use this function after you empty and clean the dispenser.</p> <ul style="list-style-type: none"> <li>You can select from <b>Auto dispenser</b> or <b>Flex auto dispenser</b>. <ul style="list-style-type: none"> <li>Pour water up to the MAX line in the dispenser, and then tap <b>Start cleaning</b>.</li> </ul> </li> </ul> <p><b>NOTE</b></p> <ul style="list-style-type: none"> <li>Before pump cleaning, empty the drum.</li> <li>During the pump cleaning process, the drum rotates to drain water. When the pump cleaning process is complete, the water inside the dispenser(s) will drain automatically. However, there may be a small amount of residual water inside the compartment, so it is recommended to empty it manually.</li> </ul>
AI pattern	<ul style="list-style-type: none"> <li>This function saves frequently used cycles and settings. When you turn the function on, the Washing machine remembers the cycles you use most and their settings (Temp., Spin, and Soil ) and displays them in frequency order.</li> </ul>
My cycles	<p>Add or remove cycles to create a personal cycle list.</p> <ul style="list-style-type: none"> <li>You can only edit a cycle to create a personal cycle when the Washing machine is not operating.</li> </ul> <p><b>NOTE</b></p> <ul style="list-style-type: none"> <li>The Eco 40-60 and Drum Clean+ cycle cannot be removed from the list of cycles.</li> <li>You can also edit My cycles in the SmartThings app.</li> </ul>
Calibration	<p>You can run calibration again for accurate weight detection.</p> <ul style="list-style-type: none"> <li>Calibration does not start if the door is not closed properly.</li> <li>The drum rotates clockwise and counterclockwise for about 3 minutes.</li> </ul>



# Operations

## Special features

### Smart control

You can connect to the SmartThings app and control your washing machine remotely.

#### Connecting your washing machine

- Download and open the SmartThings app on your mobile device
- Tap  to turn on the washing machine.
- Tap  > **General** > **Connections** > **Easy Connection**, scan the QR code to connect.

#### NOTE

- If your washing machine fails to connect with the SmartThings app, try again.
- Check your router if you experience any Internet connection problem after connecting your washing machine with the SmartThings app.
- If the Wi-Fi is off, tap  > **General** > **Wi-Fi**, and then turn the Wi-Fi on.
- Turning the washing machine's Wi-Fi on allows you connect to the washing machine via SmartThings app on your smartphone or tablet regardless of the power status of the washing machine. However, the washing machine appears offline on the SmartThings app if the washing machine's Wi-Fi is off.
- Close the door before starting the Smart Control function.

### Stay Connect

Set up the Stay Connect function in your SmartThings app. Your washing machine stays connected to the app so you can use the washing machine when you are away from home.

1. If you turn on the Stay Connect function on the SmartThings app, the washing machine will stay connect after completing a cycle.
  - The Stay Connect function will remain active for up to 24 hours if the door remains closed.
2. When the Stay Connect function is active, the Smart Control, Door Lock, and Wi-Fi icons are illuminated on your washing machine display.
3. Conveniently control your washing machine using the SmartThings app.

#### NOTE

- In some circumstances, only the Door Lock icon may be illuminated.

---

## SmartThings

---

### Wi-Fi connection

On your smartphone or tablet, go to **Settings** and turn on the wireless connection and select an AP (Access Point).

- This appliance supports the Wi-Fi 2.4 GHz and 5 GHz protocols.

### Download

On an app market (Google Play Store, Apple App Store, Samsung Galaxy Apps), find the SmartThings app with a search term of "SmartThings". Download and install the app on your device.

#### NOTE

The app is subject to change without notice for improved performance.

### Log in

You must first log into SmartThings with your Samsung account. To create a new Samsung account, follow the instructions on the app. You don't need a separate app to create your account.

#### NOTE

If you have a Samsung account, use the account to log in. A registered Samsung smartphone or tablet user automatically logs in.

### To register your appliance to SmartThings

1. Make sure your smartphone or tablet is connected to a wireless network. If not, go to **Settings** and turn on the wireless connection and select an AP (Access Point).
2. Open **SmartThings** on your smartphone or tablet.
3. If a message of "A new device is found.," select **Add**.
4. If no message appears, select **+** and select your appliance in a list of devices available. If your appliance is not listed, select **Device Type > Specific Device Model**, and then add your appliance manually.
5. Register your appliance to the SmartThings app as follows.
  - a. Add your appliance to SmartThings. Make sure your appliance is connected to SmartThings.
  - b. When registration is complete, your appliance appears on your smartphone or tablet.

#### NOTE

- Due to different product development periods, the APP names will be different. Samsung SmartThings, SmartThings, Samsung Connect, Samsung Smart Home, and Samsung Smart Connect have the same meaning.
- The product will be inconsistent with the APP interface and the manual due to functional iterations. Please refer to the actual APP interface.

# Operations

## Open Source Announcement

The software included in this product contains open source software. You may obtain the complete corresponding source code for a period of three years after the last shipment of this product by contacting our support team via <http://opensource.samsung.com> (Please use the "Inquiry" menu.)

It is also possible to obtain the complete corresponding source code in a physical medium such as a CD-ROM; a minimal charge will be required.

The following URL [http://opensource.samsung.com/opensource/SMART\\_AT\\_051/seq/0](http://opensource.samsung.com/opensource/SMART_AT_051/seq/0) leads to the open source license information as related to this product. This offer is valid to anyone in receipt of this information.



### NOTE

Hereby, Samsung declares that this radio equipment is in compliance with Directive 2014/53/EU and with the relevant statutory requirements in the UK. The full text of the EU declaration of conformity and the UK declaration of conformity is available at the following internet address: The official Declaration of conformity may be found at <http://www.samsung.com>, go to Support > Support home and enter the model name.

RF max transmitter power:

Wi-Fi	
Frequency range	Transmitter power(Max)
2412 - 2472 MHz	20 dBm
5120 - 5250 MHz	23 dBm
5250 - 5350 MHz	20 dBm
5470 - 5725 MHz	20 dBm
Bluetooth	
2402 - 2480 MHz	20 dBm

The 5 GHz WLAN function of this equipment may only be operated indoors. This equipment may be operated in all EU countries.

# Maintenance

---

Keep the washing machine clean to prevent deteriorated performance and to preserve its life cycle.

## Product Care

---

The Product Care screen offers maintenance tips to keep your Washing machine clean and prolong the product life cycle. You can check the remaining number of cycles until the next Drum clean+ duration, and start the Drum clean+ cycle.

### NOTE

If the Product Care cycle needs to be performed, a guide message will appear on the Home screen. Follow the on-screen instructions to run the Drum clean+ cycle.

1. On the Home screen tap **Product Care** to move to the Product Care screen.
2. Tap **Clean now** to start the care cycle.

## Drum clean+

---

Certain usage and environmental conditions may result in some residue build-up or odor in the drum. To prevent this build-up or odor and keep the drum fresh and clean, perform the Drum clean+ cycle at least once a month or every 40 cycles. Perform the recommended procedure below when using the Drum clean+ cycle.

1. Tap .
2. On the cycle screen, select **Product Care > Drum Clean+**.
3. Tap **Clean now**.

### NOTE

- The water temperature for Drum clean+ is defaulted to 70 °C. This temperature cannot be changed.
- Do not exceed the max line. Do not use or mix any other detergent or chemicals during the Drum clean+ cycle. If necessary, run a Rinse+Spin cycle after the Drum clean+ cycle has completed to help remove any remaining residue.

### DRUM CLEAN+ reminder

- After every 40 cycles, the Washing machine displays the “Time to run Self Clean+. Press Clean now to start the Product care cycle.” message for an hour to alert you to run the Drum clean+ cycle.
- It is recommended to run the cycle regularly for hygienic purposes
- You will see the Drum clean+ alert message when the Washing machine completes a cycle. If you open the door, the message disappears, and the display shows the Drum clean+ cycle setting screen automatically.
- The reminder will appear on the LCD panel for 5 additional consecutive cycles before turning off. The next reminder will not appear until another 40 cycles have been completed.

# Maintenance

## Emergency drain

In case of a power failure, drain the water inside the drum before taking out the laundry.

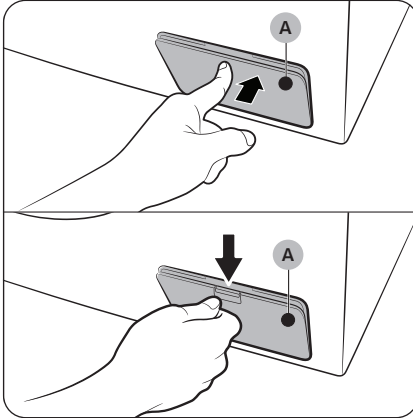

1. Power off and unplug the washing machine from the electrical outlet.
2. Open the **filter cover (A)**.
  - TYPE 1: Gently press the top area of the **filter cover (A)** to open.
  - TYPE 2: Push down the latch of the **filter cover (A)** to open.

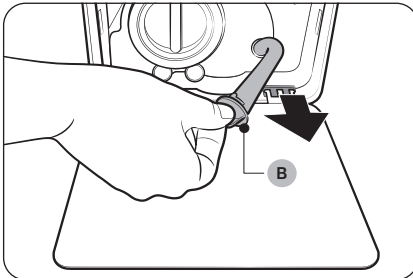

3. Put an empty, spacious container around the cover, and stretch the emergency drain tube to the container while holding the **tube cap (B)**.

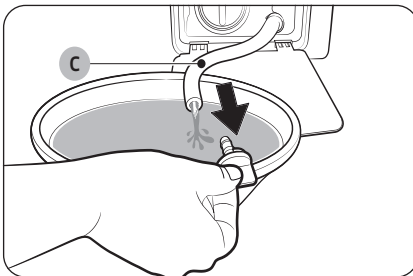

4. Open the tube cap and let water in the **emergency drain tube (C)** flow into the container.
5. When done, close the tube cap, and reinsert the tube. Then, close the filter cover.

### NOTE

Use a spacious container because the water in the drum may be more than expected.

---

## Cleaning

---

### Surface of the washing machine

Use a soft cloth with a nonabrasive household detergent. Do not spray water onto the washing machine.

### Mesh filter

Clean the mesh filter of the water hose once or twice a year.

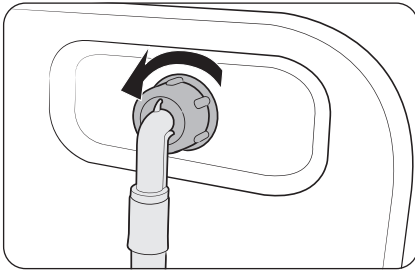

1. Turn off the washing machine, and unplug the power cord.
2. Close the water tap.
3. Loosen and disconnect the water hose from the back of the washing machine. Cover the hose with a cloth to prevent water from gushing out.

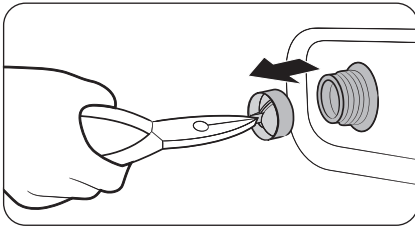

4. Use pliers to pull out the mesh filter from the inlet valve.
5. Submerge the mesh filter deeply in water so that the threaded connector is also submerged.
6. Dry the mesh filter completely in the shade.
7. Reinsert the mesh filter into the inlet valve, and reconnect the water hose to the inlet valve.
8. Open the water tap.

#### NOTE

If the mesh filter is clogged, an information code of “4C” appears on the screen.

# Maintenance

## Debris filter

It is advisable to clean the debris filter every 2 months to prevent its clogging. A clogged debris filter may reduce the bubble effect.

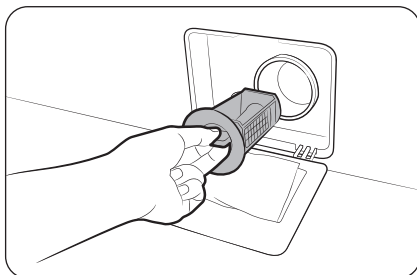

1. Turn off the washing machine, and unplug the power cord.
2. Drain the remaining water inside the drum. See the **Emergency drain** section.
3. Open the **filter cover**.
4. Turn the debris filter knob to the left, and drain off the remaining water.

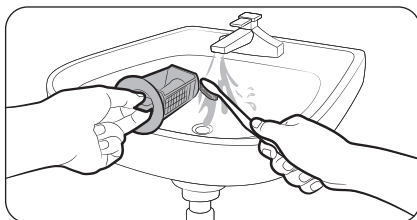

5. Clean the debris filter using soft brushes. Make sure the drain pump propeller inside the filter is unclogged.
6. Reinsert the debris filter, and turn the filter knob to the right.

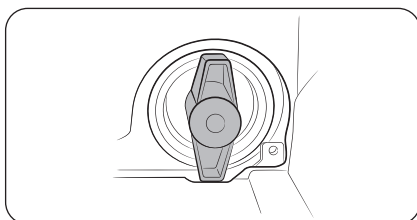

### NOTE

- Some debris filters feature a safety knob that is designed to prevent accidents by children. To open the safety knob of the debris filter, push in and turn it anticlockwise. The spring mechanism of the safety knob helps open the filter.
- To close the safety knob of the debris filter, turn it clockwise. The spring makes a rattling sound, which is normal.

### NOTE

If the pump filter is clogged, an information code of “5C” appears on the screen.

### CAUTION

- Make sure the filter knob is closed properly after cleaning the filter. Otherwise, this may cause a leak.
- Make sure the filter is inserted properly after cleaning it. Otherwise, this may cause an operational failure or a leak.

## Detergent drawer

To prevent the detergent residue buildup in the detergent drawer, clean the detergent drawer once or twice a month, and whenever you refill or change the detergent or softener.

### ⚠ CAUTION

- Make sure to turn off the washing machine and unplug the power cord before cleaning.
- If you are not going to use the washing machine for a long time, empty the dispensers and clean them thoroughly.

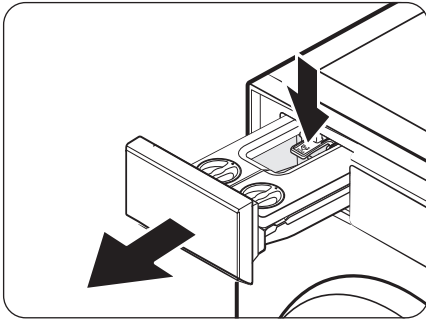

1. While holding down the **release lever** on the inner of the drawer, pull the detergent drawer to remove.

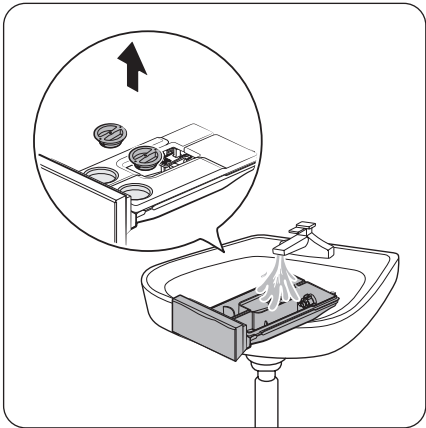

2. Open the dispenser caps and clean inside the dispensers with water.
  - Wipe the water and close the covers when you finish cleaning them.

### 📖 NOTE

If the cleaning agent in the dispenser is hardened, open the dispenser, and pour lukewarm water into the dispenser to dissolve the hardened agents. Then, clean inside the dispenser and its rear valve thoroughly.

# Maintenance

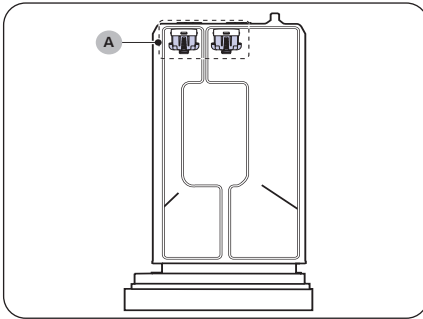

## NOTE

- Do not use a brush or another cleaning tool on **part (A)** of the detergent drawer. Rinse them with water only.
- Do not disassemble the **part (A)**.

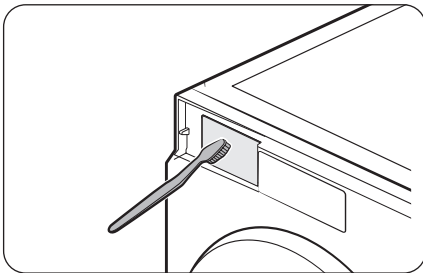

3. Clean the drawer recess using a bottle brush to remove detergent residues and limescale on the drawer recess.

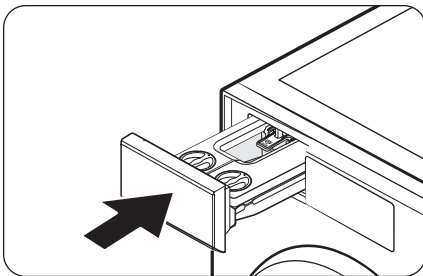

4. Insert the detergent drawer back into the washing machine.

## NOTE

- Make sure the drawer recess is completely dry before inserting the detergent drawer.
- Cover the covers of both dispensers and re-insert them into the drawer.

## CAUTION

Do not spray water into the detergent drawer recess. It may cause electric shock or fire.

---

## Defrosting your washing machine

---

The washing machine may freeze when it drops below 0 °C.

1. Turn off the washing machine, and unplug the power cord.
2. Pour warm water over the water tap to loosen the water hose.
3. Disconnect the water hose, and soak it in warm water.
4. Pour warm water into the drum and leave it for about 10 minutes.
5. Reconnect the water hose to the water tap.



### NOTE

If the washing machine still doesn't operate normally, repeat the above steps until it operates normally.

## Care against an extended time of disuse

---

Avoid leaving the washing machine unused for an extended time. If this is the case, drain the washing machine and unplug the power cord.

1. Tap .
2. On the cycle screen, select **Rinse+Spin**.
3. Empty the drum, and then tap .
4. When the cycle is complete, close the water tap and disconnect the water hose.
5. Turn off the washing machine, and unplug the power cord.
6. Open the door to let air circulate through the drum.

# Troubleshooting



If there is any problem, check the information message on the LCD screen and follow the on-screen instructions.

If the problem persists, please contact the service center.

## Checkpoints

If you encounter a problem with the washing machine, first check the table below and try these suggestions.

Problem	Action
<b>Does not start.</b>	<ul style="list-style-type: none"><li>• Make sure the washing machine is plugged in.</li><li>• Make sure the door is properly closed.</li><li>• Make sure the water taps are open.</li><li>• Tap  to start the washing machine.</li><li>• Make sure Lock is not activated.</li><li>• Before the washing machine starts to fill, it will make a series of clicking noises to check the door lock and will do quick drain.</li><li>• Check the fuse or reset the circuit breaker.</li><li>• Check if power is supplied properly.</li><li>• Low voltage detected.<ul style="list-style-type: none"><li>- Check if the power cord is plugged in.</li></ul></li><li>• Make sure laundry is not caught in the door.</li><li>• Clean the filter.</li></ul>
<b>Water supply is insufficient, or no water is supplied.</b>	<ul style="list-style-type: none"><li>• Fully open the water tap.</li><li>• Make sure the door is properly closed.</li><li>• Make sure the water supply hose is not frozen.</li><li>• Make sure the water supply hose is not kinked or clogged.</li><li>• Make sure there is sufficient water pressure.</li><li>• Make sure that the cold water tap and the hot water tap are properly connected.</li><li>• Clean the mesh filter as it may be clogged.</li></ul>
<b>After a cycle, detergent remains in the detergent drawer.</b>	<ul style="list-style-type: none"><li>• Make sure the washing machine is running with sufficient water pressure.</li><li>• Make sure the detergent is added to the centre of the detergent drawer.</li><li>• Make sure the rinse cap is inserted properly.</li><li>• If using granular detergent, make sure the detergent selector is in the upper position.</li><li>• Remove the rinse cap and clean the detergent drawer.</li></ul>

Problem	Action
<p><b>Excessive vibrations or makes noise.</b></p>	<ul style="list-style-type: none"> <li>• Make sure the washing machine is installed on a level, solid floor that is not slippery. If the floor is not level, use the levelling feet to adjust the height of the washing machine.</li> <li>• Make sure the shipping bolts are removed.</li> <li>• Make sure the washing machine is not in contact with any other object.</li> <li>• Make sure the laundry load is balanced.</li> <li>• The motor can cause noise during normal operation.</li> <li>• Overalls or clothes with metallic decorations can cause noise while being washed. This is normal.</li> <li>• Metal objects such as coins can cause noise. After washing, remove these objects from the drum or filter case.</li> <li>• Redistribute the load. If only one item of clothing needs washing, such as a bathrobe or pair of jeans, the final spin result might be unsatisfactory, and a check message will be shown in the display.</li> </ul>
<p><b>Does not drain and/or spin.</b></p>	<ul style="list-style-type: none"> <li>• Make sure the drain hose is straightened all the way to the drain system. If you encounter a drain problem, call for service.</li> <li>• Make sure the debris filter is not clogged.</li> <li>• Close the door and tap .</li> <li>For your safety, the washing machine will not tumble or spin unless the door is closed.</li> <li>• Make sure the drain hose is not frozen or clogged.</li> <li>• Make sure the drain hose is connected to a drain system that is not clogged.</li> <li>• If the washing machine is not supplied with sufficient power, the washing machine will temporarily not drain or spin. As soon as the washing machine regains sufficient power, it will operate normally.</li> <li>• Make sure the drain hose is positioned correctly, depending on the connection type.</li> <li>• Clean the debris filter as it may be clogged.</li> </ul>
<p><b>The door does not open.</b></p>	<ul style="list-style-type: none"> <li>• Tap  to stop the washing machine.</li> <li>• It may take a few moments for the door lock mechanism to disengage.</li> <li>• The door will not open until 3 minutes after the washing machine has stopped or the power has been off.</li> <li>• Make sure all the water in the drum is drained.</li> <li>• The door may not open if water remains in the drum. Drain the drum and open the door manually.</li> <li>• Make sure the door lock light is off. The door lock light turns off after the washing machine has drained.</li> </ul>

# Troubleshooting

Problem	Action
<b>Excessive suds.</b>	<ul style="list-style-type: none"> <li>• Make sure you use the recommended types of detergent as appropriate.</li> <li>• Use high efficiency (HE) detergent to prevent oversudsing.</li> <li>• Reduce the detergent amount for soft water, small loads, or lightly soiled loads.</li> <li>• Non-HE detergent is not recommended.</li> </ul>
<b>Cannot add additional detergent.</b>	<ul style="list-style-type: none"> <li>• Make sure the remaining amount of detergent and fabric softener is not over the limit.</li> </ul>
<b>Stops.</b>	<ul style="list-style-type: none"> <li>• Plug the power cord into a live electrical outlet.</li> <li>• Check the fuse or reset the circuit breaker.</li> <li>• Close the door, and tap  to start the washing machine. For your safety, the washing machine will not tumble or spin unless the door is closed.</li> <li>• Before the washing machine starts to fill, it will make a series of clicking noises to check the door lock and will do quick drain.</li> <li>• There may be a pause or soak period in the cycle. Wait briefly, and the washing machine may start.</li> <li>• Make sure the mesh filter of the water supply hose at the water taps is not clogged. Periodically clean the mesh filter.</li> <li>• If the washing machine is not supplied with sufficient power, the washing machine will temporarily not drain or spin. As soon as the washing machine regains sufficient power, it will operate normally.</li> </ul>
<b>Fills with the wrong water temperature.</b>	<ul style="list-style-type: none"> <li>• Fully open both taps.</li> <li>• Make sure the temperature selection is correct.</li> <li>• Make sure the hoses are connected to the correct taps. Flush water lines.</li> <li>• Make sure the water heater is set to supply a minimum of 49 °C hot water at the tap. Also, check the water heater capacity and recovery rate.</li> <li>• Disconnect the hoses and clean the mesh filter. The mesh filter may be clogged.</li> <li>• While the washing machine fills, the water temperature may change as the automatic temperature control feature checks incoming water temperature. This is normal.</li> <li>• While the washing machine fills, you may notice just hot and/or just cold water going through the dispenser when cold or warm temperatures are selected. This is a normal function of the automatic temperature control feature as the washing machine determines the water temperature.</li> </ul>
<b>Load is wet at the end of a cycle.</b>	<ul style="list-style-type: none"> <li>• Use the High or Extra High spin speed.</li> <li>• Use high efficiency (HE) detergent to reduce oversudsing.</li> <li>• Load is too small. Small loads (one or two items) may become unbalanced and not spin completely.</li> <li>• Make sure the drain hose is not kinked or clogged.</li> </ul>

Problem	Action
<b>Leaks water.</b>	<ul style="list-style-type: none"> <li>• Make sure the door is properly closed.</li> <li>• Make sure all hose connections are tight.</li> <li>• Make sure the end of the drain hose is correctly inserted and secured to the drain system.</li> <li>• Avoid overloading.</li> <li>• Use high efficiency (HE) detergent to prevent oversudsing.</li> <li>• Check the drain hose. <ul style="list-style-type: none"> <li>- Make sure the end of the drain hose is not placed on the floor.</li> <li>- Make sure the drain hose is not clogged.</li> </ul> </li> </ul>
<b>Has odours.</b>	<ul style="list-style-type: none"> <li>• Excessive suds collect in recesses and can cause foul odours.</li> <li>• Run cleansing cycles to sanitise periodically.</li> <li>• Clean the door seal (diaphragm).</li> <li>• Dry the washing machine interior after a cycle has finished.</li> </ul>
<b>A message appears on the display to alert that dispenser is open.</b>	<ul style="list-style-type: none"> <li>• Check if the detergent drawer is closed properly. <ul style="list-style-type: none"> <li>- Open the detergent drawer and close it again. Make sure it's closed properly.</li> </ul> </li> </ul>
<b>Increased time of washing.</b>	<ul style="list-style-type: none"> <li>• The actual washing time may differ from the estimated time initially displayed on the control panel upon cycle selection.</li> </ul>

- If a problem persists, contact a service center. The number of the service center is on the label attached to the product.
- Samsung is not liable for any damage to the product, any injury, or any other product safety issue caused by a repair which does not follow the instructions in these Repair Guides. Any damage to the product caused by an attempted repair (by anyone other than a Samsung certified service provider) will also not be covered by the warranty.

# Troubleshooting

## Information codes

If the washing machine fails to operate, you may see an information code on the screen. Check the table below and try the suggestions.

Code	Action
<b>Check drainage</b> 5C	<ul style="list-style-type: none"><li>• The washer isn't draining properly.</li><li>• Clean the drain filter, then tap Start to restart the washer. Or, turn it off and on again after 2-3 minutes, then try again.</li></ul>
<b>Check water supply</b> 4C	<ul style="list-style-type: none"><li>• Check the faucets, then tap Start to restart the washer. Or, turn it on and off again after 2-3 minutes, then try again.</li><li>• Make sure the water hoses are not clogged.</li><li>• Make sure the water taps are not frozen.</li><li>• Make sure the washing machine is operating with sufficient water pressure.</li><li>• Make sure that the cold water tap and the hot water tap are properly connected.</li><li>• Clean the mesh filter as it may be clogged.</li><li>• All buttons will be disabled for 3 minutes after the information code appears.</li><li>• When the message appears, the machine drains water for 3 minutes. In the meantime, the Power button will be disabled.</li></ul>
<b>Water is too hot.</b> 4C2	<ul style="list-style-type: none"><li>• Water is too hot. Some fabrics need to be protected.</li><li>• Check if the water supply hoses are properly connected, then tap Start to restart the washer. Or, turn it off and on again after 2-3 minutes and try again.</li></ul>
<b>The spin dry isn't performing properly</b> UB	<ul style="list-style-type: none"><li>• There isn't enough laundry or the load is unbalanced.</li><li>• Make sure the washing machine is on a flat, stable surface.</li><li>• Add more laundry or redistribute the items, then tap Start to restart the washer. Or, turn it off and on again after 2-3 minutes, then try again.</li></ul>
<b>The door is open</b> DC	<ul style="list-style-type: none"><li>• Close it and try again.</li><li>• Make sure the door is properly closed.</li><li>• Make sure laundry is not caught in the door.</li></ul>
<b>The door switch isn't working properly</b> DC1	<ul style="list-style-type: none"><li>• Check for foreign substances around the door, then push the door closed and try again.</li></ul>
OC	Water has overflowed. <ul style="list-style-type: none"><li>• Restart after spinning.</li><li>• If the information code remains on the display, contact a local Samsung service centre.</li></ul>

Code	Action
LC, LC1	<p>Check the drain hose.</p> <ul style="list-style-type: none"> <li>• Make sure the end of the drain hose is not placed on the floor.</li> <li>• Make sure the drain hose is not clogged.</li> <li>• If the information code remains, contact a customer service centre.</li> </ul>
3C	<p>Check the drum motor for operation.</p> <ul style="list-style-type: none"> <li>• Try restarting the cycle.</li> <li>• If the information code remains, contact a customer service centre.</li> </ul>
3CP	<p>The electronic control needs to be checked.</p> <ul style="list-style-type: none"> <li>• Try restarting the cycle.</li> <li>• If the information code remains, contact a customer service centre.</li> </ul>
UC	<p>Check the pulsator motor for operation.</p> <ul style="list-style-type: none"> <li>• Check if power is supplied properly.</li> <li>• If the information code remains, contact a customer service centre.</li> </ul>
	<p>Low voltage detected.</p> <ul style="list-style-type: none"> <li>• Check if the power cord is plugged in.</li> <li>• If the information code remains, contact a customer service centre.</li> </ul>
HC	<p>High temperature heating check.</p> <ul style="list-style-type: none"> <li>• If the information code remains, contact a customer service centre.</li> </ul>
1C	<p>The Water Level sensor is not working properly.</p> <ul style="list-style-type: none"> <li>• Turn the machine off, and restart the cycle.</li> <li>• If the information code remains, contact a customer service centre.</li> </ul>
AC	<p>Check communications between main and sub PBAs.</p> <ul style="list-style-type: none"> <li>• Turn the machine off, and restart the cycle.</li> <li>• If the information code remains, contact a customer service centre.</li> </ul>
8C	<p>The MEMS sensor is not working properly.</p> <ul style="list-style-type: none"> <li>• Turn the machine off, and restart the cycle.</li> <li>• If the information code remains, contact a customer service centre.</li> </ul>
AC6	<p>Check communications between the main and the inverter PBAs.</p> <ul style="list-style-type: none"> <li>• Depending on the state, the machine may automatically returns to normal operation.</li> <li>• Turn the machine off, and restart the cycle.</li> <li>• If the information code remains, contact a customer service centre.</li> </ul>

If any information code keeps appearing on the screen, contact a local Samsung service centre.

# Specifications

## Fabric care chart

The following symbols provide garment care direction. The Clothing care labels include symbols for drying, bleaching, drying and ironing, or dry cleaning when necessary. The use of symbols ensures consistency among garment manufacturers of domestic and imported items.

Follow care label directions to maximize garment life and reduce laundering problems.

### Washing

	95 °C boil wash.
	60 °C coloured wash.
	60 °C coloured wash. ("Easy care" coloured wash)
	40 °C coloured wash.
	40 °C mild wash.
	40 °C very mild wash.
	30 °C fine wash.
	30 °C mild fine wash.
	30 °C very mild fine wash.
	Hand wash.
	Do not wash.

#### NOTE

The numbers in the wash tub specify the maximum washing temperatures in degrees Celsius which must not be exceeded.

### Bleaching

	Any bleach allowed.
	Only oxygen bleach allowed.
	Do not bleach.



### Drying

	Tumble drying / Drying at a temperature of 80 °C with a normal drying process.
	Tumble drying / Drying at a temperature of 60 °C with a mild drying process.
	Do not tumble dry
	Line drying.
	Drip line drying.
	Flat drying.
	Drip flat drying.
	Line drying in the shade.
	Drip line drying in the shade.
	Flat drying in the shade.
	Drip flat drying in the shade.

#### NOTE

- The dots indicate the drying level of the dryer.
- The lines indicate the type and place of the drying.









## Ironing

	Iron at maximum sole plate temperature of 200 °C.
	Iron at maximum sole plate temperature of 150 °C.
	Iron at maximum sole plate temperature of 110 °C. Caution when using steam irons (work without steam).
	Do not iron.

### NOTE

The dots indicate the temperature ranges for ironing (regulator, steam, travel irons and ironing machines).

## Professional care

	Professional dry-cleaning in perchloroethylene and/or hydrocarbons (heavy benzines) with normal process.
	Professional dry-cleaning in perchloroethylene and/or hydrocarbons (heavy benzines) with gentle process.
	Professional dry-cleaning in hydrocarbons (heavy benzines) with normal process.
	Professional dry-cleaning in hydrocarbons (heavy benzines) with gentle process.
	Do not dry-clean.
	Professional wet-cleaning.
	Mild professional wet-cleaning.
	Very mild professional wet-cleaning.
	Do not wet-clean.

### NOTE

- The letters in a circle indicate the solvents (P, F) used in dry cleaning or wet cleaning (W).
- Generally, the line under the symbol indicates a milder treatment (e.g. gentle cycle for easy-care items). The double line indicates care levels with particularly gentle treatment.

# Specifications

## Protecting the environment

- This appliance is manufactured from recyclable materials. If you decide to dispose of it, please observe local waste disposal regulations. Cut off the power cord so that the appliance cannot be connected to a power source. Remove the lid so that animals and small children cannot get trapped inside the appliance.
- Do not exceed the detergent quantities recommended in the detergent manufacturers' instructions.
- Use stain removal products and bleaches before the wash cycle only when necessary.
- Save water and electricity by only washing full loads (the exact amount depends upon the program used).

## Spare parts guarantee

We guarantee that the following spare parts will be available to professional repairers and end-users for a minimum period of 10 years after placing the last unit of the model on the market.

- Door, door hinges and seals, other seals, door locking assembly, and plastic peripherals such as detergent dispensers.
- Listed parts can be purchased at below website.
  - <http://www.samsung.com/support>

## Standby power consumption

<b>Power consumption</b>	Off mode	0.50 W
	Network standby mode	2.00 W
	Time in networked standby mode (WI-FI)	10 min

## Specification sheet

"\*" Asterisk(s) means variant model and can be varied (0-9) or (A-Z).

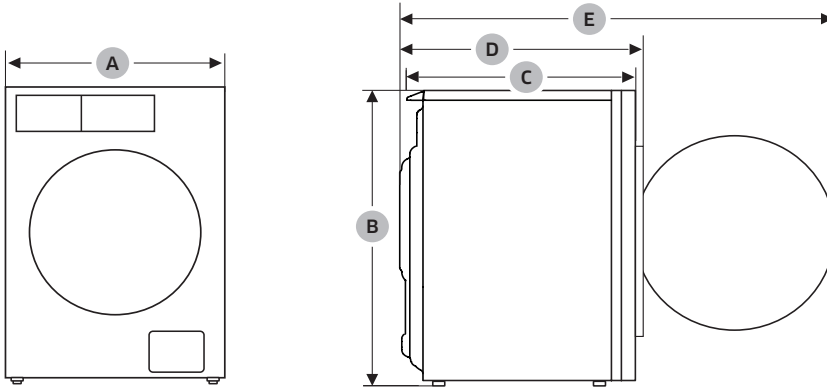

Type		Front loading washing machine		
Model name		WF9*F09C**	WF9*F11C**	
Dimensions	A (Width)	600 mm		
	B (Height)	850 mm		
	C (Depth)	600 mm		
	D	630 mm		
	E	1075 mm		
Water pressure		50-1000 kPa		
Net weight		75 kg		
Maximum load capacity		Washing and spinning	9.0 kg	11.0 kg
Power consumption	Washing and heating	AC 220-240 V / 50 Hz	1900-2300 W	
Spin revolutions		1400 RPM		

### NOTE

The design and specifications are subject to change without notice for quality improvement purposes.

# Specifications

## Indicative information (According to EU 2019/2023)

Model	Cycles	Capacity (kg)	Program Time (HH:MM)	Energy Consumption (kWh/Cycle)	Water Consumption (L/cycle)	Maximum Temperature (°C)	Remaining Moisture Content (%)	Spinning Speed (RPM)
WF9*F09C**	Eco40-60	9	3:48	0.318	81.4	25	53.9	1400
		4.5	2:54	0.218	42.5	24	53.9	1400
		3	2:54	0.145	33.8	24	53.9	1400
	Cotton 20°C	9	3:26	0.400	110.0	20	50.0	1400
	Cotton 60°C	9	2:32	1.700	127.0	60	50.0	1400
	Cotton 60°C +Bubble Soak	9	3:02	2.150	129.0	60	50.0	1400
	Synthetics 40°C	4	2:59	0.820	58.0	40	33.0	1200
	Quick Wash 15'	2	0:15	0.015	42.0	15	105.0	800
WF9*F11C**	Eco40-60	11	4:00	0.605	89.0	29	53.9	1400
		5.5	3:00	0.295	51.1	23	53.9	1400
		3	2:40	0.179	38.0	23	53.9	1400
	Cotton 20°C	11	3:26	0.400	110.0	20	50.0	1400
	Cotton 60°C	11	2:32	1.700	127.0	60	50.0	1400
	Cotton 60°C +Bubble Soak	11	3:02	2.150	129.0	60	50.0	1400
	Synthetics 40°C	4	2:59	0.820	58.0	40	33.0	1200
	Quick Wash 15'	2	0:15	0.015	42.0	15	105.0	800

- The values given for programmes other than the Eco 40-60 programme and the wash and dry cycle are indicative only.
- The time values stated here may differ from the actual values due to the influence of the water pressure/hardness/temperature, type/amount/soiling level of the laundry, type/amount of the detergent used, power supply, and the selected additional functions.

### EPREL information

To access energy labelling information about this product on the European Product Registry for Energy Labelling (EPREL), go to [https://eprel.ec.europa.eu/qr/\\*\\*\\*\\*\\*](https://eprel.ec.europa.eu/qr/*****) where \*\*\*\*\* is the product's EPREL registration number. You can find the registration number on the rating label of your product.

# Contact information

## QUESTIONS OR COMMENTS?

COUNTRY	CALL	OR VISIT US ONLINE AT
UK	0333 000 0333	<a href="http://www.samsung.com/uk/support">www.samsung.com/uk/support</a>
IRELAND (EIRE)	0818 717100	<a href="http://www.samsung.com/ie/support">www.samsung.com/ie/support</a>
GERMANY	06196 77 555 77	<a href="http://www.samsung.com/de/support">www.samsung.com/de/support</a>
FRANCE	01 48 63 00 00	<a href="http://www.samsung.com/fr/support">www.samsung.com/fr/support</a>
SPAIN	91 175 00 15	<a href="http://www.samsung.com/es/support">www.samsung.com/es/support</a>
PORTUGAL	"210 608 098 Chamada para a rede fixa nacional Dias úteis das 9h às 20h"	<a href="http://www.samsung.com/pt/support">www.samsung.com/pt/support</a>
LUXEMBURG	261 03 710	<a href="http://www.samsung.com/be_fr/support">www.samsung.com/be_fr/support</a>
NETHERLANDS	088 90 90 100	<a href="http://www.samsung.com/nl/support">www.samsung.com/nl/support</a>
BELGIUM	02-201-24-18	" <a href="http://www.samsung.com/be/support">www.samsung.com/be/support</a> (Dutch) <a href="http://www.samsung.com/be_fr/support">www.samsung.com/be_fr/support</a> (French) "
NORWAY	21 62 90 99	<a href="http://www.samsung.com/no/support">www.samsung.com/no/support</a>
DENMARK	70 70 19 70	<a href="http://www.samsung.com/dk/support">www.samsung.com/dk/support</a>
FINLAND	030-622 75 15	<a href="http://www.samsung.com/fi/support">www.samsung.com/fi/support</a>
SWEDEN	0771-400 300	<a href="http://www.samsung.com/se/support">www.samsung.com/se/support</a>
AUSTRIA	0800 72 67 864 (0800-SAMSUNG)	<a href="http://www.samsung.com/at/support">www.samsung.com/at/support</a>
SWITZERLAND	0800 726 786	" <a href="http://www.samsung.com/ch/support">www.samsung.com/ch/support</a> (German) <a href="http://www.samsung.com/ch_fr/support">www.samsung.com/ch_fr/support</a> (French) "
HUNGARY	0680SAMSUNG (0680-726-7864)	<a href="http://www.samsung.com/hu/support">www.samsung.com/hu/support</a>
CZECH	"800 - SAMSUNG (800-726786)"	<a href="http://www.samsung.com/cz/support">www.samsung.com/cz/support</a>
SLOVAKIA	"0800 - SAMSUNG (0800-726 786)"	<a href="http://www.samsung.com/sk/support">www.samsung.com/sk/support</a>
CROATIA	072 726 786	<a href="http://www.samsung.com/hr/support">www.samsung.com/hr/support</a>
BOSNIA	055 233 999	<a href="http://www.samsung.com/ba/support">www.samsung.com/ba/support</a>
North Macedonia	023 207 777	<a href="http://www.samsung.com/mk/support">www.samsung.com/mk/support</a>
MONTENEGRO	020 405 888	<a href="http://www.samsung.com/support">www.samsung.com/support</a>
SLOVENIA	080 697 267 (brezplačna številka)	<a href="http://www.samsung.com/si/support">www.samsung.com/si/support</a>
SERBIA	011 321 6899	<a href="http://www.samsung.com/rs/support">www.samsung.com/rs/support</a>

COUNTRY	CALL	OR VISIT US ONLINE AT
Kosovo	038 40 30 90	<a href="http://www.samsung.com/support">www.samsung.com/support</a>
ALBANIA	045 620 202	<a href="http://www.samsung.com/al/support">www.samsung.com/al/support</a>
BULGARIA	"0800 111 31 - Безплатен за всички оператори *3000 - Цена на един градски разговор или според тарифата на мобилният оператор 09:00 до 18:00 - Понеделник до Петък"	<a href="http://www.samsung.com/bg/support">www.samsung.com/bg/support</a>
ROMANIA	"0800872678 - Apel gratuit *8000 - Apel tarifat în rețea Program Call Center Luni - Vineri: 9 AM - 6 PM"	<a href="http://www.samsung.com/ro/support">www.samsung.com/ro/support</a>
ITALIA	800-SAMSUNG (800.7267864)	<a href="http://www.samsung.com/it/support">www.samsung.com/it/support</a>
CYPRUS	8009 4000 only from landline, toll free	<a href="http://www.samsung.com/gr/support">www.samsung.com/gr/support</a>
GREECE	"80111-SAMSUNG (80111 726 7864) from mobile and land line (+30) 210 6897691 from mobile and land line"	
POLAND	"801-172-678* * (opłata według taryfy operatora)"	<a href="http://www.samsung.com/pl/support/">http://www.samsung.com/pl/support/</a>
LITHUANIA	8-800-7777	<a href="http://www.samsung.com/lt/support">www.samsung.com/lt/support</a>
LATVIA	8000-7267	<a href="http://www.samsung.com/lv/support">www.samsung.com/lv/support</a>
ESTONIA	800-7267	<a href="http://www.samsung.com/ee/support">www.samsung.com/ee/support</a>

# Memo

---

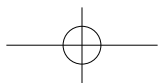
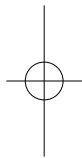
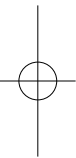
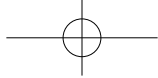

**SAMSUNG**

