

ZIP HydroTap® G4

User Manual

- Tap Functions.....(Pages 2-4)
- Tap Operation.....(Pages 5-10)
- LCD Screen & Menu(Pages 11-22)
- Maintenance..... (Pages 23-26)
- Contact details.....(Page 28)

Date of Installation...../...../.....

CS Residential

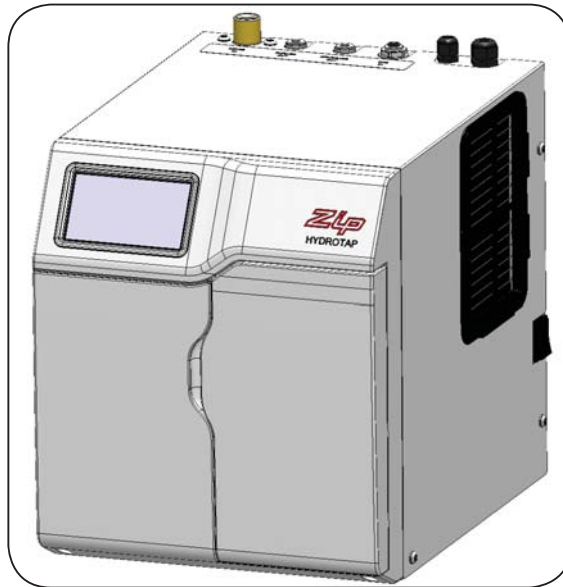

**Affix Model Number Label
Here**

802269

For safe keeping store this book
in the inside door pocket



Tap functions

HydroTap Classic:

The HydroTap Classic uses lever controls, to dispense Chilled and Chilled Sparkling water.

There are Blue indicator lights, built into the levers, to show the status of the chilled water.

There is a filter warning light to indicate when a filter change is due

NOTE: The safety button on all Chilled Sparkling models is inactive, as this function is only necessary for Boiling water models



Elite Tap:

The Elite tap uses touch sensitive controls, to dispense Chilled and Chilled Sparkling water.

When operating the tap, ensure the touch surface is dry as moisture may interfere with the sensor touch control.



Tap functions

HydroTap Arc/Cube:

On powerup, wait 30 secs. for the unit to calibrate. Tapping the select button will allow the selection of either the Chilled (BLUE) or Sparkling (White) water mode.

The Arc/Cube control may be rotated in a forward or reverse direction to dispense Sparkling or Chilled water.

The rotary control is spring loaded in the anticlockwise direction and when released, will return to the OFF position. When rotated clockwise the tap operates in a "Pot fill" mode. Water will flow from between 5 and 15 seconds (This is user adjustable). To reset, return the handle to the "Off" position and repeat the step. The lever has to be manually returned to the "Off" position. When unattended, the control light will automatically default to the Chilled (BLUE) mode after 30 seconds.

The spout may be fixed in one of 6 positions and does not swivel.

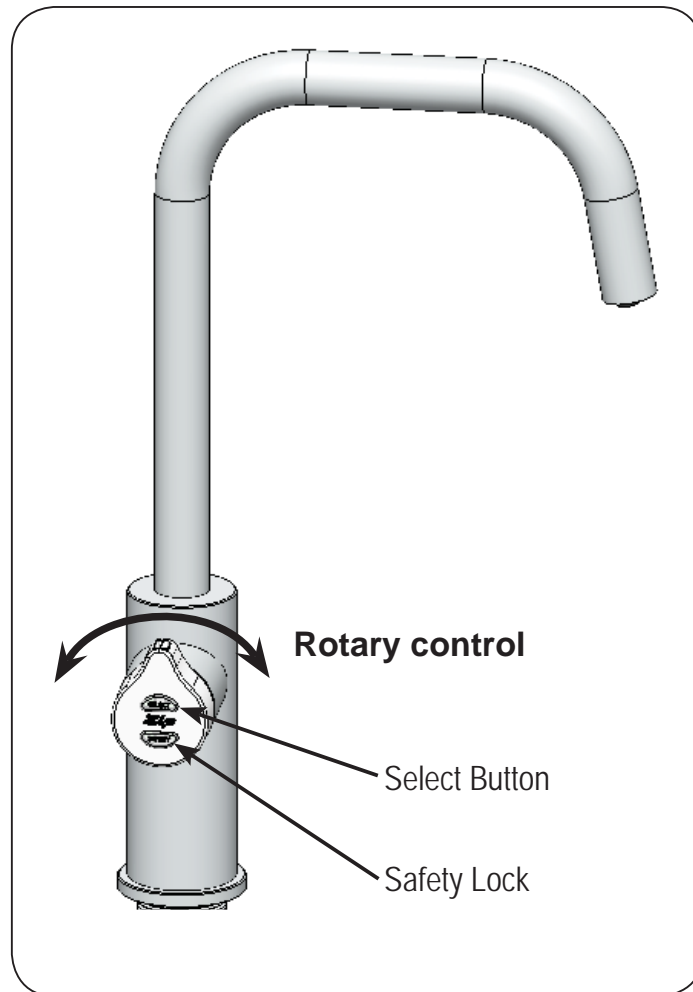

Tap functions

Celsius Arc/Cube:

On powerup, wait 30 secs. for the unit to calibrate. The Celsius rotary control may be rotated clockwise to dispense Sparkling water or anti-clockwise for Chilled water.

The rotary control is spring loaded and when released, will return to the OFF position.

The mixer control operates in a conventional way to dispense Hot and ambient water direct from the customers mains and hot water service. The mixed water is not filtered, unless an external filter has been fitted.

The warning light will flash when the chilled and sparkling water filter is due for replacement.

For convenience the spout may be swivelled 170° left or right.

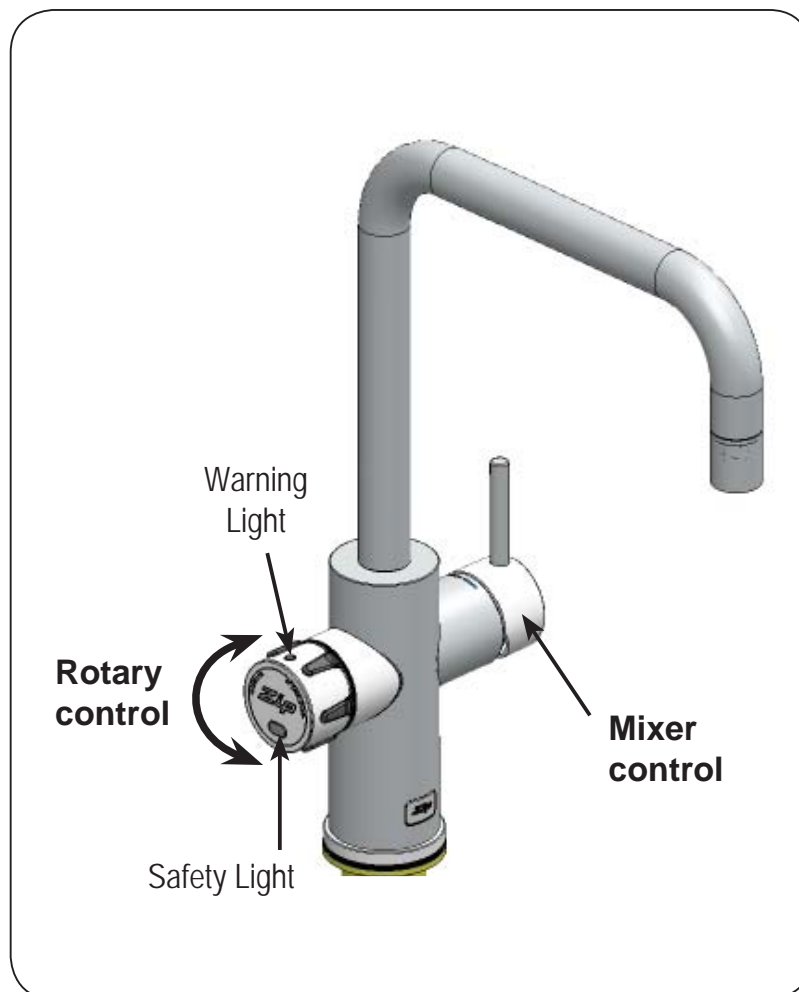

Tap operation - Chilled

To dispense chilled water: (Classic Tap)

To dispense Chilled water:

Depressing the "Chilled" lever allows the dispensing of Chilled water. Pulling forward the lever allows the tap to operate in a "no-touch" mode. Water will flow from between 5 and 15 seconds (This is user adjustable). To reset, return the handle to the "Off" position and repeat the step. The lever must be manually returned to the "Off" position.

NOTE:

Chilled water will not be dispensed, if the safety button is accidentally covered.

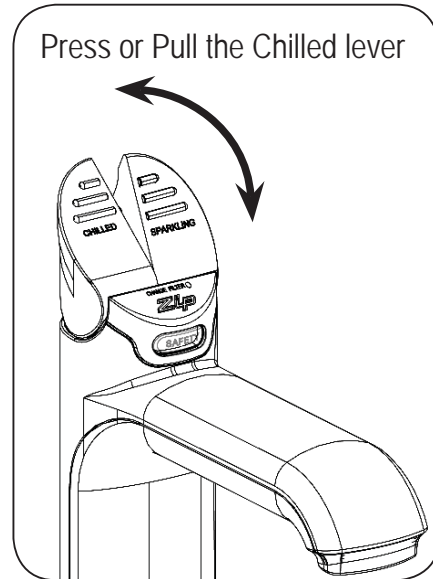

Elite Tap:

Touching the chilled button allows the dispensing of chilled water.



Tap operation - Chilled

HydroTap Arc/Cube:

If not showing BLUE, tap the select button until the indicator light turns BLUE.

Rotating the control, when the indicator light is BLUE, allows the dispensing of chilled water.

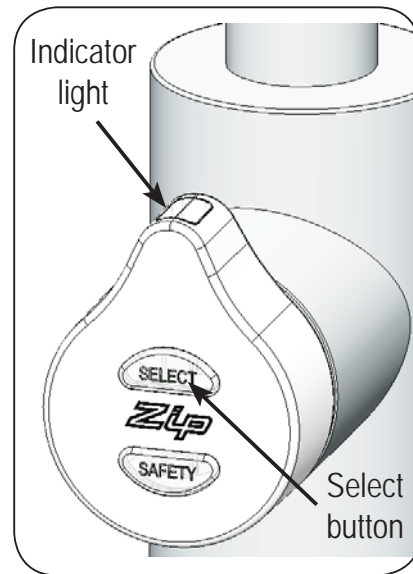

Arc/Cube Tap

Celsius Tap:

Turn the rotary control anti-clockwise to dispense chilled water as shown



Tap operation - Sparkling

To dispense Sparkling water: (Classic tap)

To dispense Sparkling water:

Depressing the 'Sparkling' lever allows the dispensing of Sparkling water. Pulling forward the lever allows the tap to operate in a "no-touch" mode. Water will flow from between 5 and 15 seconds (This is user adjustable). To reset, return the handles to the "Off" position and repeat the step. The lever must be manually returned to the "Off" position.



Elite Tap:

Touching the Sparkling button allows the dispensing of sparkling water.



Tap operation - Sparkling

HydroTap Arc/Cube:

If showing BLUE, tap the select button until the indicator light turns WHITE.

Rotating the control, when the indicator light is WHITE, will allow the dispensing of sparkling water. When unattended, the control light will automatically default to the Chilled (BLUE) mode after 30 seconds.

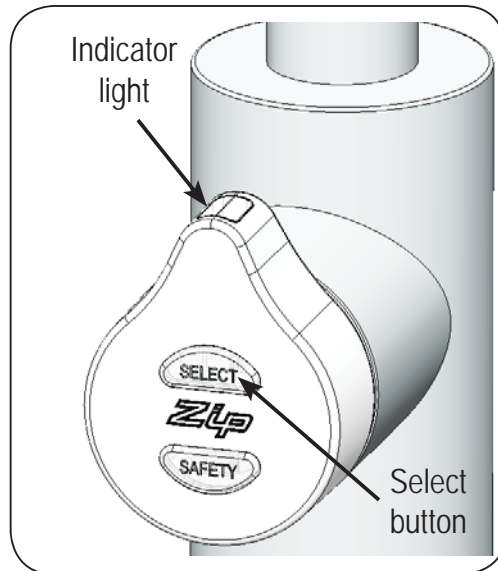

Arc/Cube Tap

Turning the rotary control allows the dispensing of either Chilled Sparkling or Chilled water. For your convenience, the rotary control is spring loaded, so when released, will return automatically to the OFF position

Celsius Arc/Cube:

Turn the rotary control clockwise to dispense sparkling water as shown



Tap operation - Mixer

The Mixer tap lever is operated as a conventional 'Flick Mixer'. The hot side is marked with a red stripe and the cold side with a blue stripe, for dispensing cold to warm water.

Lifting the handle up will decrease the flow rate and lowering the handle will increase the flow rate. Lift the handle all the way up to turn the tap off.

When the handle is moved towards the blue mark, the temperature is decreased and when moved towards the red mark, the temperature is increased. The final temperature will be dependant on the temperature of the incoming cold water.

The spout may be swivelled, left or right, through 170° for convenience.

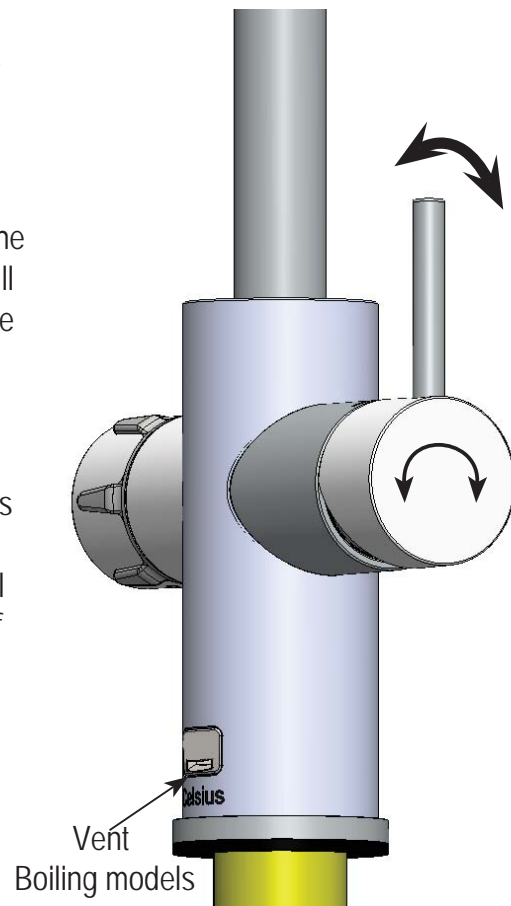

Tap lights

Blue Chilled Water Light: (Classic & AIO taps)

On all the time:

This indicates that the temperature of the chilled water is within the set temperature range.

Flashing slowly:

This indicates that the chilled water is not within the set temperature range. When the chilled water is at the set temperature, the light will stop flashing. This could take several minutes. During heavy usage, the temperature can rise out of this range.



Tap lights

Filter light: (Classic, Elite & AIO taps)

Filter Change Light Off:

This indicates the filter is operating within its normal specified lifespan.

Filter Change light flashing slowly:

The light will flash slowly when the filter is due for replacement and the LCD will show "Filter Change". Refer to "Replacing the filter" in section 'C' of this document.



Turn filter light OFF: (All models)

Refer to "Filter Reset" in section 'C' of this document.

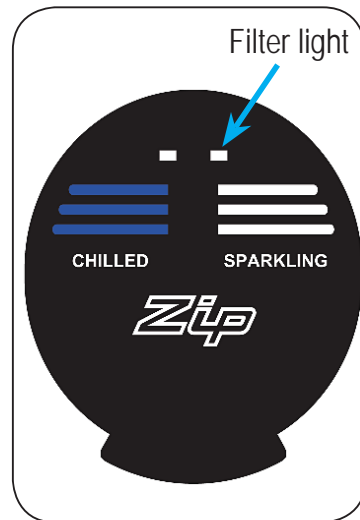

Filter light: HydroTap Arc/Cube:

Flashing filter lights:

All three tap lights (Safety; Select and Indicator light) will flash every 10 seconds, indicating a Filter change is required.

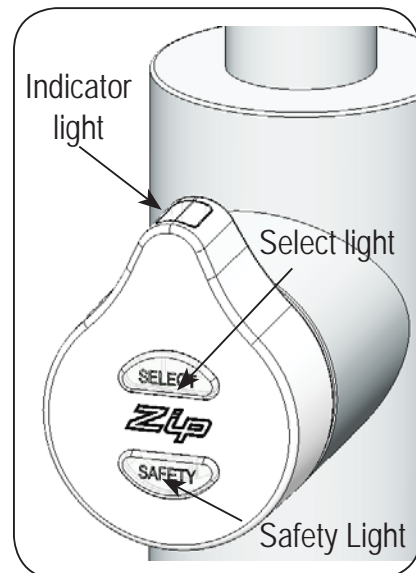

Warning: (All)

Flashing warning light:

When the indicator light flashes fast and continuous, a system fault has occurred. Check for details on the faults screen. If unable to rectify, call a qualified service agent.

LCD Screen

Zip HydroTap G4 introduces a 'TOUCH' screen for easy setup and operation adjustment.

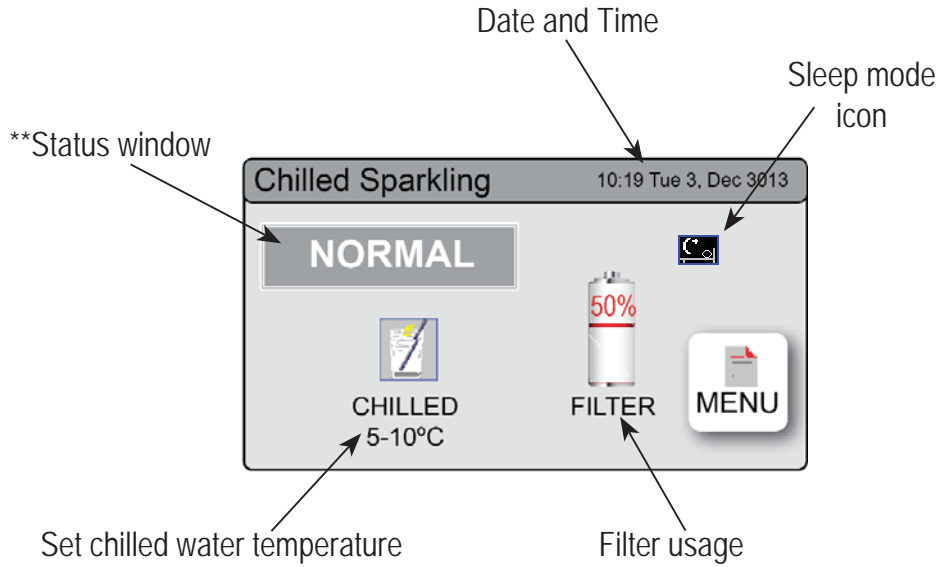

Other possible messages in status window:

Status**	Information	Notes
System Fault	Product has one or more system faults	Refer to section B
Change Filter	External/Internal filter needs to be replaced	Refer to section C

Note: When selecting Menu options, the screen will revert to the main menu, if the screen remains inactive for a period, in excess of 10 seconds.

LCD Screen Menu

Main Menu	Sub Menu	Sub Menu Options	Section
Language	<ul style="list-style-type: none"> English 		A
	<ul style="list-style-type: none"> Product Info System Faults Event Log 	<ul style="list-style-type: none"> Product serial no. Lists Energy usage 	B
Information			
Installation	<ul style="list-style-type: none"> Filter Flush Filter Reset Purge CO₂ Lux sensor 	<ul style="list-style-type: none"> Reset options Calibration options Advanced options 	C
Service	Password protected		D
Security	<ul style="list-style-type: none"> Enable Password 	<ul style="list-style-type: none"> Set Password Change Password 	E
Communication	<ul style="list-style-type: none"> Remote Monitor 	<ul style="list-style-type: none"> Wifi Options 	F
Settings	<ul style="list-style-type: none"> Date/Time Temperature Filter Dispense Times 	<ul style="list-style-type: none"> 12hr/24hr Mode Cold Setpoint Filter Life (Litres) Filter Life (Months) Cold Dispensing 	G

LCD Screen operation - Section A

A Set Language

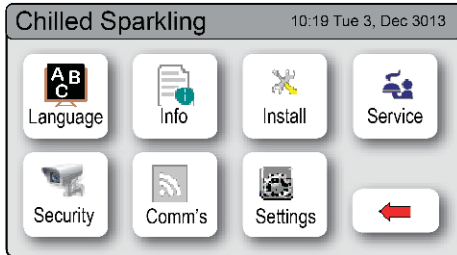

1. Press [MENU] for main menu.
2. Press [Language] button.
3. Select an option to change the language
4. Press [<=] button for the previous menu

LCD Screen operation - Section B

B System Information

In this section, you can find product information, system faults and filter log messages.

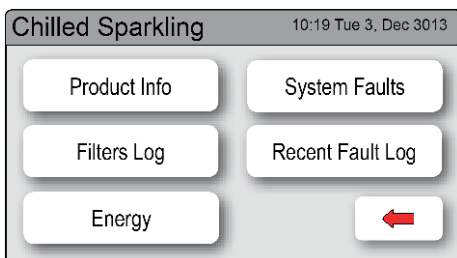

1. Press the [MENU] button for the main menu.
2. Press the [Info] button to view the current product serial number and other key information

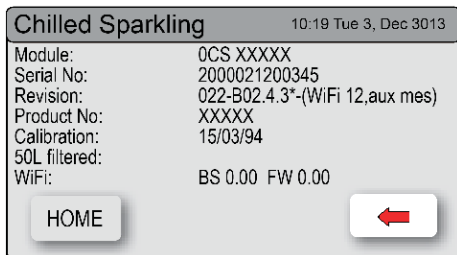

1. Press [Product Info] to view the current product information.
2. Press [<=] button for the previous menu or press [Home] button to return to the home screen.

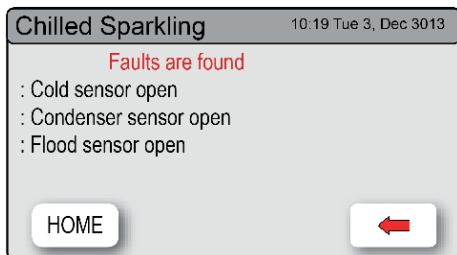

1. Press [System Faults] to check the fault information;
2. Press [<=] button for the previous menu or press [Home] button to return to the home screen.

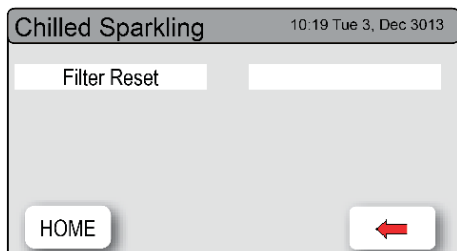

1. Press [Filters Log] to view the system's filter log.
2. Press [<=] button for the previous menu or press [Home] button to return to the home screen.

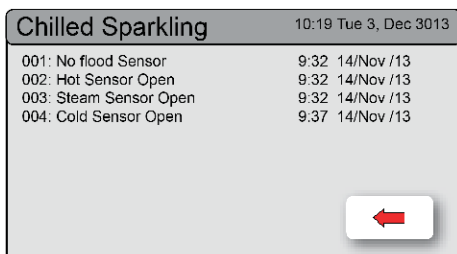

1. Press [Recent Faults Log] to view the last 4 recorded faults.
2. Press [<=] button for the previous menu or press

LCD Screen operation - Section B

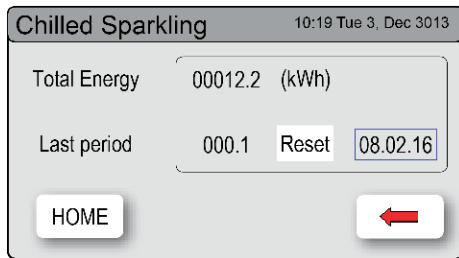

1. Press [Energy] to view Energy information.
2. The Total energy consumption will be displayed, or
3. Select a date to view the energy used for that period
4. Press [=] for the previous menu or press [Home] to return to the home screen.

LCD Screen operation - Section C

C Install

Once your Zip HydroTap G4 unit has been installed, select the Install menu to configure the system settings for your product.

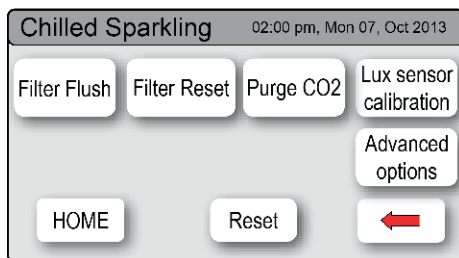

Sub menu:

- 1 - Filter Flush
- 2 - Filter Reset
- 3 - Purge CO₂
- 4 - Lux sensor calibration
- 5 - Advanced options
- 6 - Reset

1 - Filter Flush

Have a bucket or similar container (not supplied) at the ready to hold a quantity of water that will be ejected while the Filter Flush Mode is in operation. Open the filter access door on the front of the HydroTap and the filter cartridge will be exposed. Located to the rear RHS of the cartridge is a flush line, approx 600mm long and the flush line stop cock. Place the free end of the flush line into the bucket or container (not supplied).

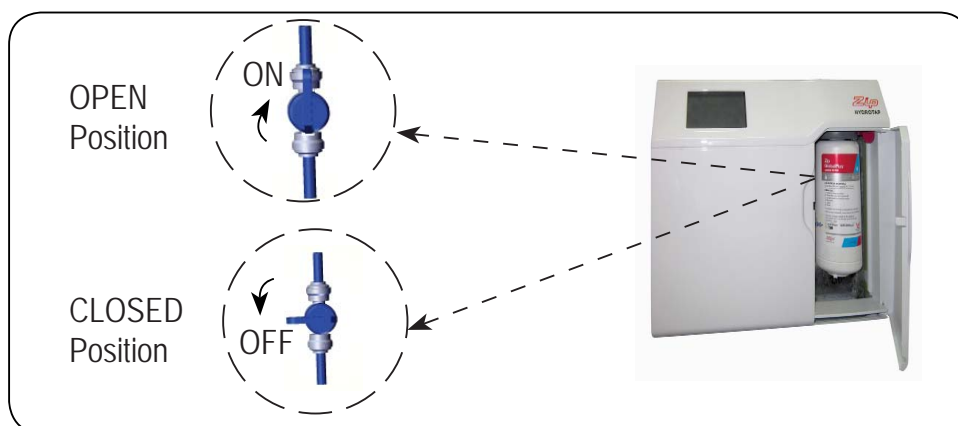

The Zip HydroTap allows the user to adjust the filter life and to edit the filter usage. (See filter details on Page 20).

LCD Screen operation - Section C

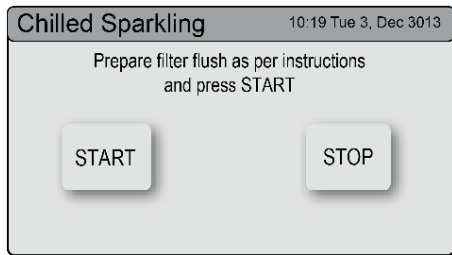

Note: Run at least 10 Ltrs of water through to flush the filter of any excess black carbon particles (this is normal), before pressing the Stop button. Once the filter flush has finished, press the Stop button to display the main menu

1. Press the [MENU] button for main menu.
2. Press the [Install] button. Turn the stop cock ON.
3. Press the [Filter Flush] button.
4. Press [Start] [Stop] buttons to start and Stop the filter flush. Once the filter flush is finished, Turn the stop cock OFF first (to ensure the cock is properly closed) then press [Stop] to end filter flush mode.
5. Press [=] button for the previous menu or press [Home] button to return to the home screen.
6. After initial installation, Turning OFF the Filter Flush Mode puts the HydroTap into calibration mode. With subsequent filter changes, the system reverts to the main menu.

2 - Filter Reset

After replacing the filter, the counters should be reset

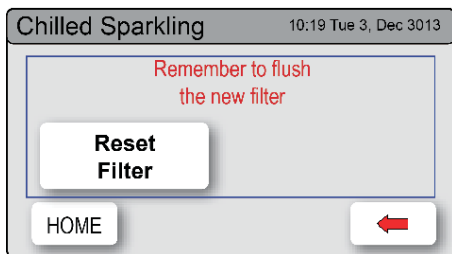

1. Press the [MENU] button for main menu.
2. Press the [Install] button.
3. Press the [Filter Reset] button.
4. In the next screen, press [YES] button if you want to flush the filter. Follow the filter flush steps to start filter flush or press [NO] to cancel the filter reset program. To set the filter life or edit filter usage, refer to section G- Filter.

LCD Screen operation - Section C

3 - Purge CO₂

When fitting a new gas bottle, it is important to purge the gas lines.

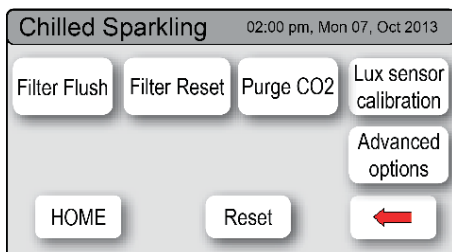

1. Press the [MENU] button for main menu.
2. Press the [Install] button.
3. Press the [Purge CO₂] button.
4. In the next screen, press the [START] button to commence the purging process.
5. Wait for the water to stop flowing through the unit.
6. Wait a further 10 seconds after the water has stopped flowing. During this time you will hear the CO₂ gas escaping through the tap.
7. Press [STOP] to end the purge.
8. Press [=] button for the previous menu or press the [Home] button to return to the home screen.

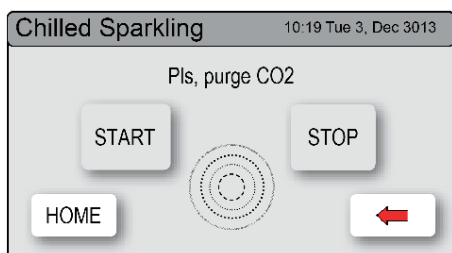

4 - Lux Sensor Calibration

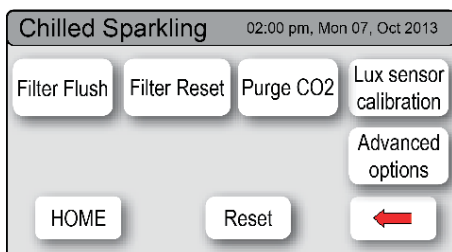

1. Press [MENU] button for main menu.
2. Press [Install] button.
3. Press [Lux Sensor Calibration] button.
4. The lights on the Tap head will flash to confirm calibration.
5. Check for correct tap operation by selecting 'Lux Sensor-> OFF'. When the room is darkened (below the calibrated light level), the tap lights will turn OFF after approx 30 seconds.

5 - Advanced options

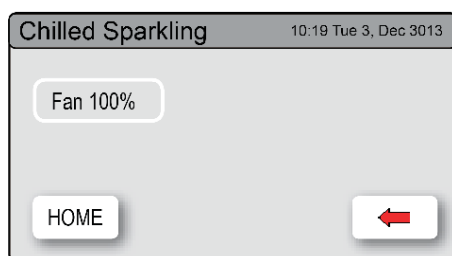

1. Press [MENU] for main menu.
2. Press [Install] .
3. Press [Advanced Options].
4. You may adjust the fan speed to 50% or 75% or 100%

6 - Reset

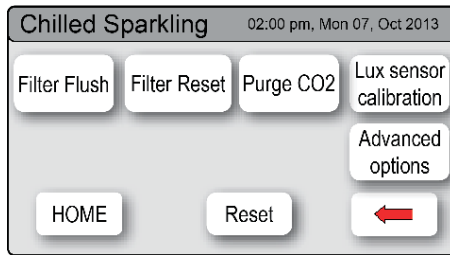

1. Press [MENU] for main menu.
2. Press [Install] .
3. Press [Reset]. to reset the factory default settings

LCD Screen operation - Section D

D Service

This section is reserved for service technicians only

Note: In Australia call a licensed electrician, plumber, or Zip office on 1800-638-633, for assistance, service, spare parts, or enquiries.

LCD Screen operation - Section E

E Security

The Zip HydroTap G4 allows the appliance coordinator to set up a password to protect against users changing the preferred system settings.

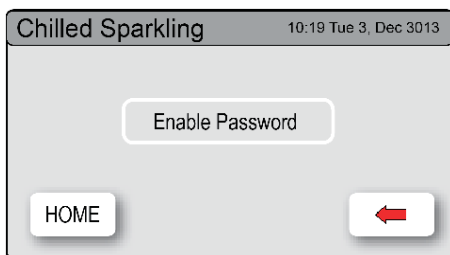

To set a password

1. Press the [MENU] button for main menu.
2. Press the [Security] button.
3. Press [Enable Password]
4. Enter a 4 digit password

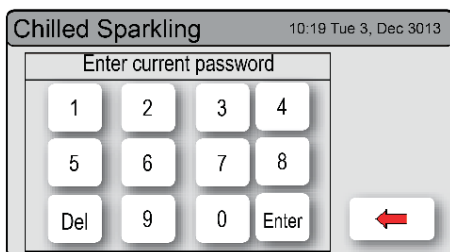

To change a password

1. Press the [MENU] button for main menu.
2. Press the [Security] button.
3. Press [Change Password]
4. Enter your old 4 digit password
5. Then enter your new 4 digit password. You will need to enter your password to access the settings screen. If you have forgotten the password, please disconnect the power and restart your HydroTap unit.



LCD Screen operation - Section F

F Communication - WiFi (Select models)

This section allows the user to use WiFi to monitor the product remotely.



1. From the Home screen Press [Menu]. Then [Comm's]
2. Enter your 4 digit password to access the WiFi set up.
3. Follow the set up instructions supplied with the WiFi unit

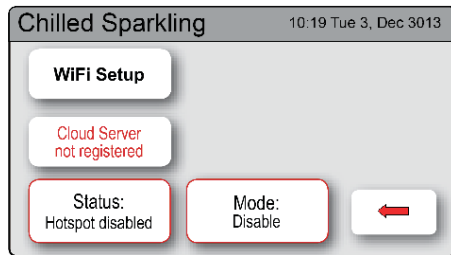

To disable the WiFi setup

1. Press [WiFi setup]
2. In the next screen Press [Disable]
3. Press [=] button for the previous menu

LCD Screen operation - Section G

G Settings

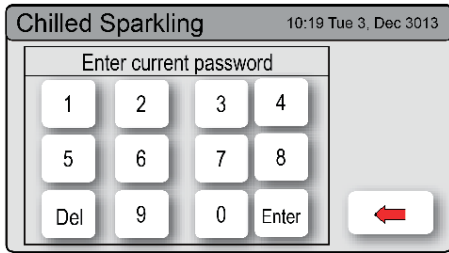

1. Press the [MENU] button for main menu.
2. Press the [Settings] button.
3. Press [Enable Password].
4. Then enter your 4-digit password.

You will need to enter your password to access the settings screens. If you have forgotten the password, please disconnect the power and restart your HydroTap unit.

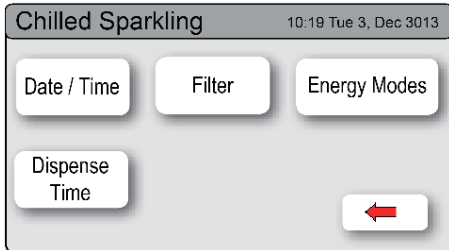

Set Date / Time

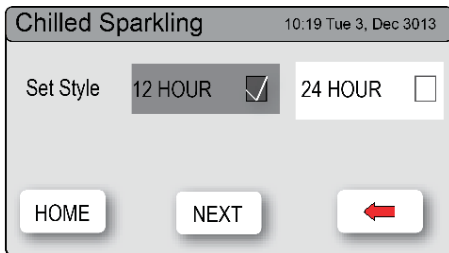

HydroTap G4 Set Date/Time Screen

1. Press the [MENU] button for main menu.
2. Press the [Setting] button.
3. Press the [Date/Time] button.
4. Choose 12 hour mode or 24 hour mode by pressing the square button. The selected mode will be displayed in dark grey colour with a tick box on the right.
5. Press [NEXT] button to set the date and time using the up and down scroll keys.

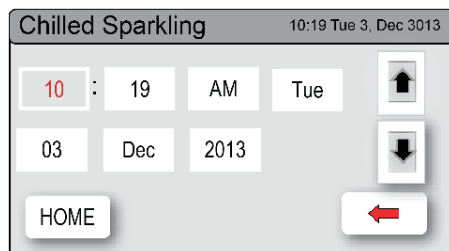

1. Select individually the hour, minutes and day and adjust using the up and down arrows.
2. Select individually the date, month and year and adjust using the up and down arrows.
3. Press [HOME] to return to the Home screen.

LCD Screen operation - Section G

Filter

Zip HydroTap G4 allows the user to adjust filter life and edit filter usage.

Note: The filter life may be set as a function of Litres used, or in months from the filter change. When the first of these functions is reached (i.e. Litres or months expired), the filter warning light will be illuminated on the tap. Either of these functions may be disabled (See below).

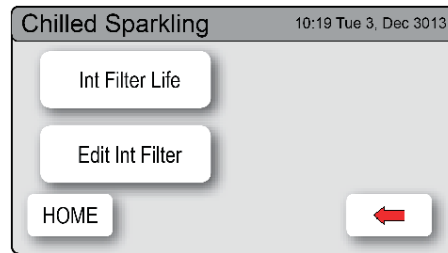

To edit the filter life:

1. Press [MENU] button for main menu.
2. Press [Setting] button.
3. Press [Filter] button.
4. Press [Filter Life] button, for Internal filter.
5. To change filter life, first select filter life (Litres) or filter life (Months), then adjust using the up or down arrows.

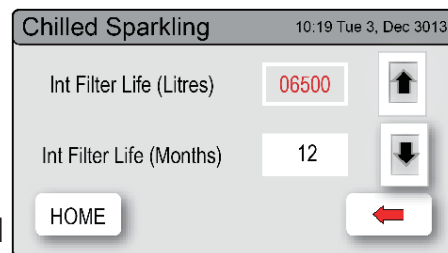

Note:

Filter Life increases in 500 litres increments to a maximum of 10000 litres. Factory set at 6000 litres.

To edit the filter usage:

This function is to reset the Filter Change display after a filter has reached the end of its life (refer to "Replace Filter Instructions" section of this document).

1. Press the [MENU] button for main menu.
2. Press the [Setting] button.
3. Press the [Filter] button.
4. Press the [Edit Filter] button for Internal filter.
5. To edit, select Edit Usage(Litres) or Edit Usage (Months), then adjust using the up or down arrows.
6. Press [HOME] to return to the Home screen.

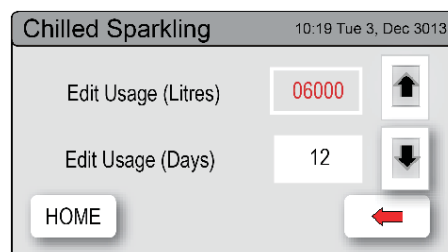

LCD Screen operation - Section G

Energy Modes

This mode allows the HydroTap to enter into an Energy Saving mode. There are two options available: 'Sleep' mode and 'ON/OFF' mode.

In SLEEP MODE the unit will go to "Sleep" after a 2hr period of inactivity. The Chilled water will be ON or OFF.

When the period of inactivity passes, the home screen status window will show "Sleep Mode".

To activate the sleep mode:

1. Press [MENU] button for main menu.
2. Press [Setting] button.
3. Press [Energy Modes] button.
4. Press [Sleep Modes] button then in the next screen, use the up and down arrows to select one of the 4 options as shown in the table below.

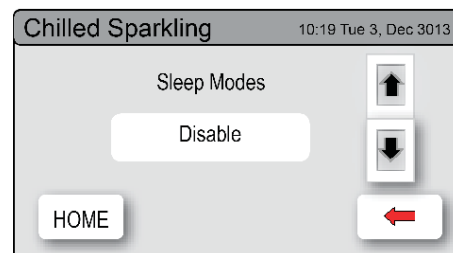
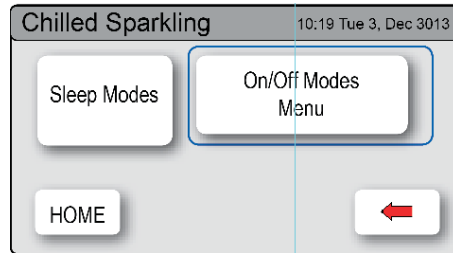

Sleep Mode	Light Level	Time Delay	State	Chiller
2 Hours-> OFF	N/A	2 Hr	OFF	OFF
Lux Sensor-> OFF	Dark	N/A	OFF	OFF
Lux or 2 Hr-> OFF	Dark	2 Hr	OFF	OFF
Disable	N/A	N/A	ON	ON

Lux (Light) Sensor Calibration:

It is recommended to recalibrate the Lux (Light) Sensor after selecting any of the Lux sensor options from the sleep mode menu. Before commencing, ensure there are 'Normal to Dim' (Not Dark) operating light conditions.

Note: Refer to section C4 for calibration procedure

Note: Any attempt, during OFF mode, to dispense water, will bring the unit out of sleep mode. The unit will return to sleep mode after 2 hours of non use. Please allow sufficient time for the water to reach the set temperature after disabling the sleep mode.

LCD Screen operation - Section G

In **ON / OFF Mode** the user may turn the unit ON or OFF at specific times for individual days or alternatively by weekly and/or weekend settings.

To activate ON/OFF mode:

1. Press the [MENU] button for main menu.
2. Press the [Setting] button.
3. If required, Enter your 4 digit password
4. Press the [Energy Modes] button.
5. Select 'Individual set' if you wish to allocate a specific time for each day.
6. Select 'group set 1' if you wish to allocate the same time to all 7 days
7. Select 'Group set 2' if you wish to allocate the same time to the 5 working days (Mon-Fri) and additional times for (Sat-Sun).



Individual set screen

This screen allows you to select the individual days for programming. Only one ON /OFF period is allowed for each day

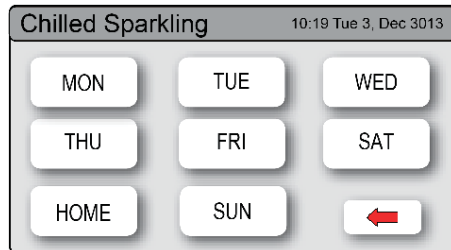

Group set screen

1. Press Group 1 or Group 2 option
2. Press button (A) to enable / disable group set. When the enable box is ticked, this allows each individual day to have an "On/Off" time.
3. Press [ON/OFF Modes] button, to set up ON/OFF time.
4. When in Group 2 Press [NEXT] to select Sat-Sun options

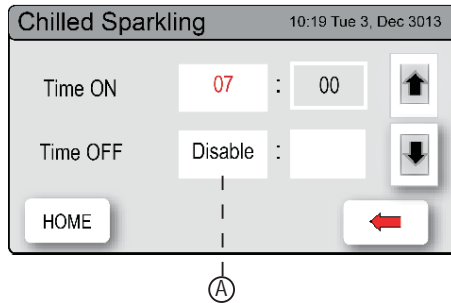

Note: Any attempt, during OFF mode, to dispense water, will bring the unit out of energy mode. The system will revert to the energy mode setting after 30 minutes of non use.

LCD Screen operation - Section G

Dispense Times

The ability to change the maximum dispensing time has been introduced. The default settings for the maximum dispensing times is 15 seconds. Here, the operator may change the Chilled and Sparkling dispensing times, to between 5 and 15 seconds, in increments of 1 second.

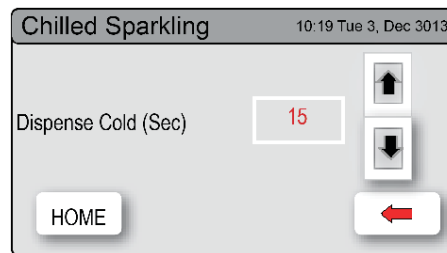

To edit the dispensing times:

1. Press the [MENU] button for main menu.
2. Press the [Setting] button.
3. Press the [Dispense Time] button.
4. Select the option to change and scroll using the up and down arrow Keys

Filter Maintenance

Water Filter

The Zip HydroTap notifies when a filter replacement is due. If you notice one of the following, you will need to change the filter:

- The Change Filter light will flash white once a second and remains so until reset.
- The filter percentage will show 0% on the Home screen.

Note: Depending on local water quality conditions and usage, the filter may require changing anywhere from 500 Ltrs to 10,000 Ltrs. You may also need to replace the filter if you notice unpleasant odours or tastes.

Some water may drip from the filter head (socket) during replacement. Keep a towel handy to dry up any drips.

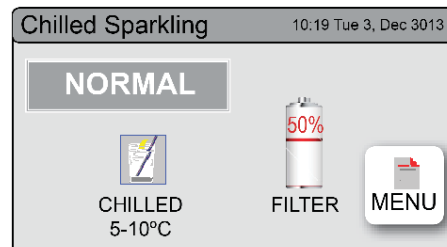

To change the Filter: (See also Section C)

- Open the door of the under sink unit.
- Relieve system pressure via the filter flush stop cock, a quick open and close will do. Use the bucket to catch the discharge.
- Grasp filter cartridge, depress the red lever at the top right of the filter and rotate the cartridge a quarter turn to the left, then gently pull down.

Filter Maintenance

- **Caution:** a small amount of water will drip as the cartridge is removed.
- Do not tilt the cartridge as water may spill from it if tilted.
- Unpack replacement cartridge and remove sanitary cap, write today's date where shown on the label.
- Avoid touching the filter O-rings and filter opening as this may cause bacterial contamination of the cartridge.
- Moisten the O-rings with water, align the front cartridge label to the left (as shown in the "insert filter" diagram for filter cartridge replacement), and push the new cartridge into the filter head.
- Turn the cartridge a quarter turn to the right until the cartridge comes to complete stop and is locked into position, with the front label facing forward.
- Initiate the filter flush programme by scrolling through the menu screen (See section C).
- When completed, wipe up any spills and dispose of spent filter cartridge and packaging thoughtfully.
- Close the door to secure the appliance.
- Adjust the filter settings in Section G - filter - Litres and Days used.

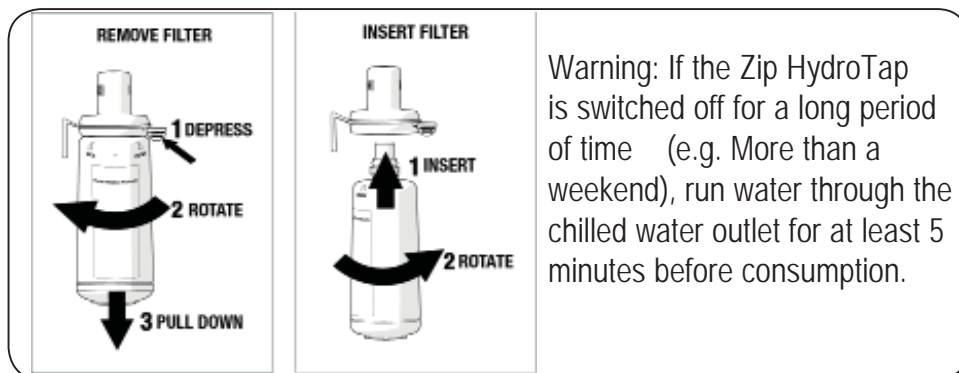

Air Inlet Filter

The Zip HydroTap air filter is conveniently located on the outside of the condenser. The filter screen is a sliding fit in the plastic housing on the side of the under sink unit. The screen may be removed for cleaning, by sliding it forward. This needs to be inspected at least quarterly, cleaned and replaced if damaged.

Note: For best performance the unit should only be operated with a clean air filter screen, correctly fitted in place. Maintain, at least, a 50mm air gap in front of the screen at all times. Take care not to allow cloths or other soft materials to accidentally block the air inlet.

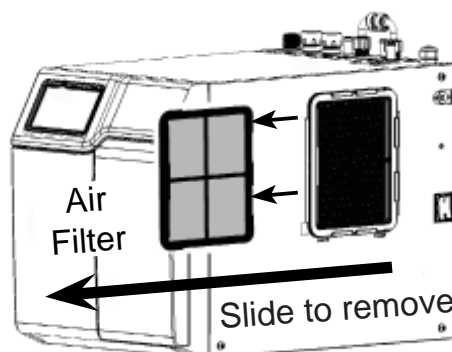

Gas bottle change

1. Turn the CO₂ bottle regulator OFF (Anti-clockwise). The knob will screw up and away from the bottle.
2. Remove the bottle from the cupboard and disconnect the regulator. If the braided hose is removed from the regulator, be careful not to loose the small plastic sealing olive, located inside the end of the hose.
3. Fit the regulator and hose assembly to the new gas bottle. Be aware that some CO₂ may be discharged from the bottle joint. Any CO₂ released will be cold.
4. Fit the bottle in an upright position (use the hook-and-loopsecuring strap).
5. Turn the regulator ON (Clockwise) and adjust to 2.7-3.0 bar. (Green zone on dial).
6. Check all joints for gas leaks using a sponge and soapy water.
7. Press the [MENU] button for main menu.
8. Press the [Install] button.
9. Press the [Purge CO₂] button.
10. In the next screen, press the [START] button to commence the purging process.
11. Wait for the water to stop flowing through the unit. Then wait a few seconds more, until you hear only CO₂ gas escaping through the tap.
12. Press [STOP] to end the purge
13. Press [=] button for the previous menu or press the [Home] button to return to the home screen.
14. The display screen should revert to Normal operation.
15. Dispense some sparkling water from the tap and perform a taste test.

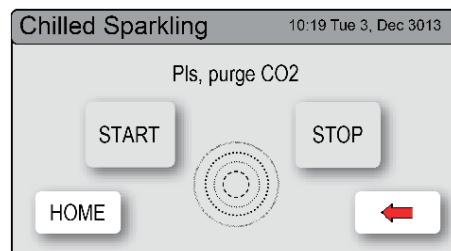
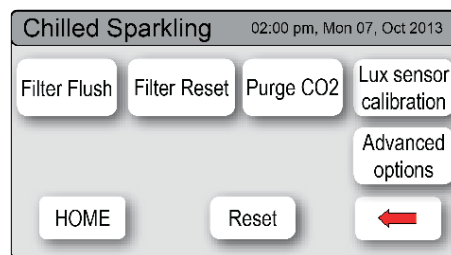

Note: The 1.0 kg gas bottle supplied with this appliance is a disposable item and cannot be refilled. Please contact your local city council for collection centre details or return the bottle to your service agent for recycling.

Cleaning

General cleaning

Do not use strong, corrosive, spray or abrasive cleaners. Clean with a soft damp cloth and mild soap.

Under sink units must never be located near, or cleaned with water jets.

Avoid using airborne pesticides near the undersink unit.

Home Menu Icons

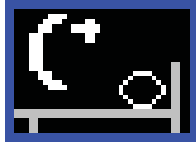

Sleep mode is active.

There are 3 sleep mode options which display this icon on the home screen. See page 17 for details.



Filter use.

This icon displays the filter usage remaining from 100% (New filter) to 0% (end of life). When it reaches 0% the filter warning light on the tap head will flash slowly.

The filter life can be adjusted by litres and by days used. See page 16

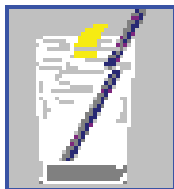

Chilled Temperature

The set temperature of the water in the Chiller tank will be displayed. This is will range from 3-5°C

CHILLED
3-5°C

Contact Details

Head Office

Zip Heaters (Aust) Pty. Ltd.
ABN: 46 000 578 727
67 Allingham Street
Condell Park NSW 2200
Postal: Locked Bag 80
Bankstown 1885 Australia

Website: www.zipwater.com
Facsimile: (02) 9796 3858
Telephone: (02) 9796 3100
Free Call: 1 800 638 633

As Zip policy is one of continuous product improvement, changes to specifications may be made without prior notice. Images in this booklet have been modified and may not be true representations of the finished goods.

The terms "Zip" and "HydroTap" are registered trade marks of Zip Heaters (Aust) Pty Ltd.

Zip products described in this publication are manufactured under one or more of the following patents: AU675601, AU637412, AU635979, GB0422305, GB2065848, US4354049, US5103859, US5099825 and SA2006/08043. Other patents are in force and patent applications are pending.

