

Owner's Guide  
Brugervejledning  
Bedienungsanleitung  
Gebruikershandleiding  
Guía del usuario  
Käyttöohje  
Notice d'utilisation  
Manuale di istruzioni  
Kezelési útmutató  
Brukerveiledning  
Podręcznik użytkownika  
Manual do Proprietário  
Bruksanvisning  
คู่มือผู้ใช้  
사용자 안내서  
用戶指南  
使用者指南  
取扱説明書  
دليل المالك

**BOSE**

**SOUNDTOUCH® 20**  
**SERIES III**  
WIRELESS SPEAKER

# IMPORTANT SAFETY INSTRUCTIONS

---

## Please read and keep all safety and use instructions.

### WARNINGS/CAUTIONS



Do not ingest battery, chemical burn hazard. The remote control supplied with this product contains a coin/button cell battery. If the coin/button cell battery is swallowed, it can cause severe internal burns in just in just 2 hours and can lead to death. Keep new and used batteries away from children. If the battery compartment does not close securely, stop using the remote control and keep it away from children. If you think batteries might have been swallowed or placed inside any part of the body, seek immediate medical attention. To avoid risk of explosion, fire or chemical burn, use caution in replacing the battery and replace only with an agency approved (e.g., UL) CR2032 or DL2032 3-volt lithium battery. Properly and promptly dispose of used batteries. Do not recharge, disassemble, heat above 212°F (100°C) or incinerate.

1. Read these instructions.
2. Keep these instructions.
3. Heed all warnings.
4. Follow all instructions.
5. Do not use this apparatus near water or moisture.
6. Clean only with a dry cloth.
7. Do not block any ventilation openings. Install in accordance with the manufacturer's instructions.
8. Do not install near any heat sources, such as radiators, heat registers, stoves, or other apparatus (including amplifiers) that produce heat.
9. Protect the power cord from being walked on or pinched, particularly at plugs, convenience receptacles, and the point where they exit from the apparatus.
10. Only use attachments/accessories specified by the manufacturer.
11. Unplug this apparatus during lightning storms or when unused for long periods of time.
12. Refer all servicing to qualified service personnel. Servicing is required when the apparatus has been damaged in any way: such as power supply cord or plug is damaged; liquid has been spilled or objects have fallen into the apparatus; the apparatus has been exposed to rain or moisture, does not operate normally, or has been dropped.



The lightning flash with arrowhead symbol within an equilateral triangle alerts the user to the presence of uninsulated, dangerous voltage within the system enclosure that may be of sufficient magnitude to constitute a risk of electric shock.



The exclamation point within an equilateral triangle alerts the user to the presence of important operating and maintenance instructions in the owner's guide.

- To reduce the risk of fire or electrical shock, do NOT expose this product to rain, liquids or moisture.
- Do not expose this apparatus to dripping or splashing, and do not place objects filled with liquids, such as vases, on or near the apparatus. As with any electronic products, use care not to spill liquids into any part of the product. Liquids can cause a failure and/or a fire hazard.
- Do not place naked flame sources, such as lighted candles, on or near the apparatus.
- Make no modifications to the system or accessories. Unauthorized alterations may compromise safety, regulatory compliance, and system performance.



This product contains magnetic material. Consult your physician on whether this might affect your implantable medical device.

# IMPORTANT SAFETY INSTRUCTIONS

## NOTES:

- Where the mains plug or appliance coupler is used as the disconnect device, such disconnect device shall remain readily operable.
- This product must be used indoors. It is neither designed nor tested for use outdoors, in recreation vehicles, or on boats.
- The product label can be located on the back or bottom of the system.



Contains small parts which may be a choking hazard. Not suitable for children under age 3.



**Please dispose of used batteries properly, following local regulations.** Do not incinerate.



This symbol means the product must not be discarded as household waste, and should be delivered to an appropriate collection facility for recycling. Proper disposal and recycling helps protect natural resources, human health and the environment. For more information on disposal and recycling of this product, contact your local municipality, disposal service, or the shop where you bought this product.

## Information about products that generate electrical noise

This equipment has been tested and found to comply with the limits for a Class B digital device, pursuant to Part 15 of the FCC rules. These limits are designed to provide reasonable protection against harmful interference in a residential installation. This equipment generates, uses, and can radiate radio frequency energy and, if not installed and used in accordance with the instructions, may cause harmful interference to radio communications. However, there is no guarantee that interference will not occur in a particular installation. If this equipment does cause harmful interference to radio or television reception, which can be determined by turning the equipment off and on, the user is encouraged to try to correct the interference by one or more of the following measures:

- Reorient or relocate the receiving antenna.
- Increase the separation between the equipment and receiver.
- Connect the equipment to an outlet on a different circuit than the one to which the receiver is connected.
- Consult the dealer or an experienced radio/TV technician for help.

## FCC WARNING

Changes or modifications not expressly approved by Bose Corporation could void the user's authority to operate this equipment.

## Important USA and Canada compliance Information

This device complies with part 15 of the FCC rules and Industry Canada license-exempt RSS standard(s). Operation is subject to the following two conditions: (1) this device may not cause harmful interference, and (2) this device must accept any interference received, including interference that may cause undesired operation.

This equipment complies with FCC and Industry Canada radiation exposure limits set forth for an uncontrolled environment. This equipment should be installed and operated with a minimum distance of 20 cm between radiator and your body.

This equipment must not be co-located or be operating in conjunction with any other antennas or transmitters.

This device complies with Industry Canada license-exempt RSS standards(s).

This Class B digital apparatus complies with Canadian ICES-003.

## CAN ICES-3 (B)/NMB-3(B)

**CE** Bose Corporation hereby declares that this product is in compliance with the essential requirements and other relevant provisions of Directive 2014/53/EU and all other EU directive requirements. The complete declaration of conformity can be found at: [www.Bose.com/compliance](http://www.Bose.com/compliance)

# REGULATORY INFORMATION

Names and Contents of Toxic or Hazardous Substances or Elements						
Toxic or Hazardous Substances and Elements						
Part Name	Lead (Pb)	Mercury (Hg)	Cadmium (Cd)	Hexavalent (CR(VI))	Polybrominated Biphenyl (PBB)	Polybrominated diphenylether (PBDE)
PCBs	X	0	0	0	0	0
Metal Parts	X	0	0	0	0	0
Plastic Parts	0	0	0	0	0	0
Speakers	X	0	0	0	0	0
Cables	X	0	0	0	0	0

This table is prepared in accordance with the provisions of SJ/T 11364.

O: Indicates that this toxic or hazardous substance contained in all of the homogeneous materials for this part is below the limit requirement of GB/T 26572.

X: Indicates that this toxic or hazardous substance contained in at least one of the homogeneous materials used for this part is above the limit requirement of GB/T 26572.

## Please complete and retain for your records

The serial and model numbers are located on the back or bottom of the product.

Serial number: \_\_\_\_\_

Model number: \_\_\_\_\_

Please keep your receipt with your owner's guide. Now is a good time to register your Bose product. You can easily do this by going to <http://global.Bose.com/register>

**Date of Manufacture:** The eighth digit in the serial number indicates the year of manufacture; "6" is 2006 or 2016.

**China Importer:** Bose Electronics (Shanghai) Company Limited, Part C, Plan 9, No. 353 North Riyang Road, China (Shanghai) Pilot Free Trade Zone

**EU Importer:** Bose Products B.V., Gorslaan 60, 1441 RG Purmerend, The Netherlands

**Taiwan Importer:** Bose Taiwan Branch, 9F-A1, No.10, Section 3, Minsheng East Road, Taipei City 104, Taiwan  
Phone Number: 886 2 2514 7977

**Mexico Importer:** Bose de México, S. de R.L. de C.V. , Paseo de las Palmas 405-204, Lomas de Chapultepec, 11000 México, D.F. Phone Number: +5255 (5202) 3545

**U.S. Phone Number:** 1-877-230-5639

## REGULATORY INFORMATION

---

Amazon, Kindle, Fire and all related logos are trademarks of Amazon, Inc. or its affiliates.

Apple and the Apple logo are trademarks of Apple Inc., registered in the U.S. and other countries. App Store is a service mark of Apple Inc.

Android, Google Play, and the Google Play logo are trademarks of Google Inc.

The *Bluetooth*® word mark and logos are registered trademarks owned by Bluetooth SIG, Inc. and any use of such marks by Bose Corporation is under license.

This product contains the iHeartRadio service. iHeartRadio is a registered trademark of iHeartMedia, Inc.

SoundTouch and the wireless note design are registered trademarks of Bose Corporation in the U.S. and other countries.

This product incorporates Spotify software which is subject to 3rd party licenses found here:  
[www.spotify.com/connect/third-party-licenses](http://www.spotify.com/connect/third-party-licenses)

Spotify is a registered trademark of Spotify AB.

Wi-Fi is a registered trademark of Wi-Fi Alliance®.

©2017 Bose Corporation. No part of this work may be reproduced, modified, distributed or otherwise used without prior written permission.

# CONTENTS

---

## **Carton Contents**

What's in the carton.....	8
---------------------------	---

## **Initial Setup**

Placement guidelines .....	9
Connect the speaker to power .....	10

## **Speaker Controls**

Power on the speaker .....	11
Control buttons .....	11

## **SoundTouch® App Setup**

Download and install the SoundTouch® app .....	12
SoundTouch® Owner's Center.....	12

## **Existing SoundTouch® Users**

Add the speaker to an existing account.....	13
Connect the speaker to a new network.....	13

## **Preset Personalization**

Set a preset .....	14
Play a preset .....	15

## **Bluetooth® Technology**

Connect your mobile device.....	16
Disconnect a mobile device.....	17
Reconnect a mobile device.....	18
Connect using the <i>Bluetooth</i> feature on your mobile device .....	18
Clear the speaker's <i>Bluetooth</i> pairing list .....	18
Use the SoundTouch® app.....	18

## **Wired Connections**

Connect to the AUX connector.....	19
-----------------------------------	----

## **Wi-Fi® Indicator**

Wi-Fi status .....	20
--------------------	----



**Messages on the Display**

Display icons..... 21

**Advanced Features**

Update software..... 22  
 Disable Wi-Fi capability ..... 22  
 Re-enable Wi-Fi capability..... 22

**Care and Maintenance**

Clean the speaker ..... 23  
 Customer service ..... 23  
 Limited warranty information ..... 23  
 Technical information..... 23  
 Replace the remote control battery..... 24

**Troubleshooting**

Common solutions ..... 25  
 Reset your speaker..... 27  
 Get diagnostic information ..... 27

**Appendix: Computer Setup**

Set up your speaker using a computer ..... 28  
     Before you begin ..... 28  
     Computer setup ..... 28



## CARTON CONTENTS

---

# What's in the carton

---

Carefully unpack the carton and confirm that the following parts are included.

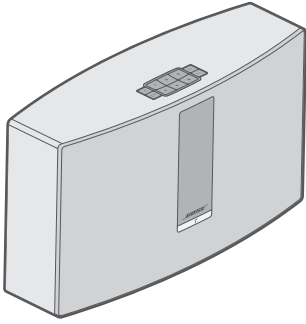

SoundTouch® 20 series III  
wireless speaker

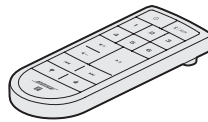

Remote control

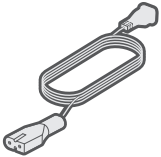

Power cord\*

\*May ship with multiple power cords. Use the power cord for your region.

**Note:** If part of the speaker is damaged, do not use it. Contact your authorized Bose® dealer or Bose customer service. Visit: [global.Bose.com/Support/ST20III](http://global.Bose.com/Support/ST20III) for contact information.

## Placement guidelines

---

To avoid interference, keep other wireless equipment 1 – 3 ft. (0.3 – 0.9 m) away from your speaker. Place your speaker outside and away from metal cabinets, and direct heat sources.

- Place your speaker on its rubber base on a stable and level surface.
- Do NOT place your speaker on top of audio/video equipment (receivers, TVs, etc.), or any other object that may generate heat. Heat generated by these items may result in poor speaker performance.
- Do NOT place any objects on top of your speaker.
- Make sure there is an AC (mains) outlet nearby.

## Connect the speaker to power

---

Before you set up the speaker on your network, connect the speaker to power.

1. Plug the power cord into the **POWER** connector on the speaker.

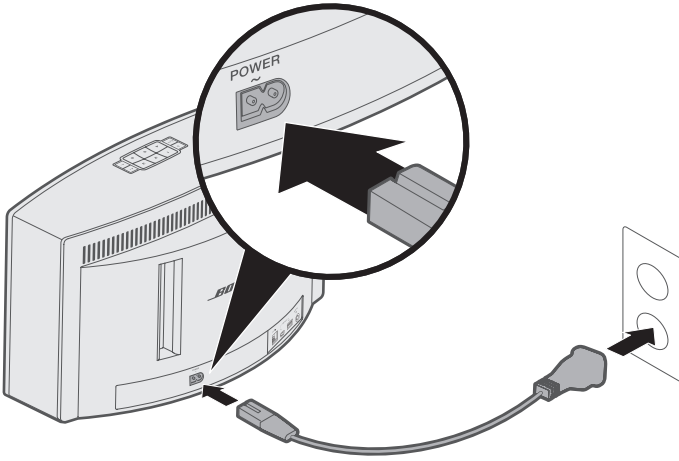

2. Plug the other end of the power cord into an AC (mains) power outlet.

## Power on the speaker

On the button pad or the remote control, press .







**Tip:** You can also press a preset or  | **AUX** to power on the speaker.

## Control buttons

The speaker controls are on the button pad and on the remote control.

**Tip:** You can also control the speaker using the SoundTouch® app.

- **Button pad:** Power on the speaker, set and play your presets, adjust the volume, and activate the *Bluetooth* and auxiliary sources.
- **Remote control:** Provides the same functionality as the button pad, as well as: Skip Backward/Skip Forward, Play/Pause, and Thumbs Up/Thumbs Down.

Button	Description
	Six preset buttons: <ul style="list-style-type: none"> <li>• Press and hold to set a preset</li> <li>• Press a preset to play</li> </ul>
	<i>Bluetooth</i> /Auxiliary button: <ul style="list-style-type: none"> <li>• Press to toggle between the <i>Bluetooth</i> and auxiliary source</li> </ul>
	Volume Up/Volume Down: Press to increase/decrease volume
	Skip Backward/Skip Forward through tracks (remote control only)
	<ul style="list-style-type: none"> <li>• Play/Pause audio</li> <li>• Mute/Unmute audio on AUX-connected device (remote control only)</li> </ul>
	Like/Dislike content playing (remote control only)

## SOUNDTOUCH® APP SETUP

---

The SoundTouch® app lets you set up and control SoundTouch® from your smartphone, tablet or computer. Using the app, your smart device acts as a remote for your speaker.

From the app, you can manage your SoundTouch® settings, add music services, explore local and global Internet radio stations, set and change presets and stream music. New features are added periodically.

**Note:** If you have already set up SoundTouch® for another speaker, see “Existing SoundTouch® Users” on page 13.

## Download and install the SoundTouch® app

---

On your smartphone or tablet, download the Bose® SoundTouch® app.



### SoundTouch® app

- **Apple users:** download from the App Store
- **Android™ users:** download on the Google Play™ store
- **Amazon Kindle Fire users:** download from the Amazon Appstore for Android



Follow the instructions in the app to complete setup, including adding the speaker to your Wi-Fi network, creating a SoundTouch® account, adding a music library and using music services.

Once you set up the speaker on your home Wi-Fi network, you can control it from any smartphone or tablet on the same network.

**Note:** For instructions on using a computer for setup, see page 28.

**Tip:** Once you set up the speaker on your home Wi-Fi network, you can control it from any smartphone or tablet on the same network. Download the SoundTouch® app on the smart device. You must use the same SoundTouch® account for all devices connected to your speaker.

## SoundTouch® Owner's Center

---

 [global.Bose.com/Support/ST20III](https://global.Bose.com/Support/ST20III)

This website provides access to the owner support center, which includes: owner's manuals, articles, tips, tutorials, a video library, and the owner community where you can post questions and answers.

## Add the speaker to an existing account

---

If you have already set up SoundTouch® on another speaker, you do not need to download the SoundTouch® app again.

From within the app, select  > **Settings** > **Add or Reconnect Speaker**.

The app guides you through setup.

## Connect the speaker to a new network

---

If your network information changes, add your speaker to your new network. You can do this by putting your speaker into setup mode.

1. From within the app, select  > **Settings** > **Speaker Settings** and select your speaker.
2. Select **CONNECT SPEAKER**.

The app guides you through setup.

## PRESET PERSONALIZATION

---

You can personalize six presets to your favorite streaming music services, stations, playlists, artists, albums or songs from your music library. You can access your music, at any time, with a simple touch of a button using the SoundTouch® app.

Before using presets, note the following:

- You can set presets from the app and the remote control.
- If the preset source is your music library, make sure the computer storing your music library is on and connected to the same network as the SoundTouch® speaker.
- You cannot set presets in *Bluetooth* mode or *AUX* mode.

## Set a preset

---

1. Stream music using the app.
2. While the music is playing, press and hold a preset on the button pad or remote control until you hear a tone.

“New preset assigned” appears on the display.

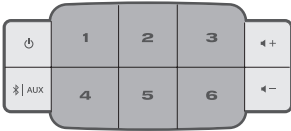

## Play a preset

Once you personalize your presets, press a preset on the button pad or on the remote control to play music.

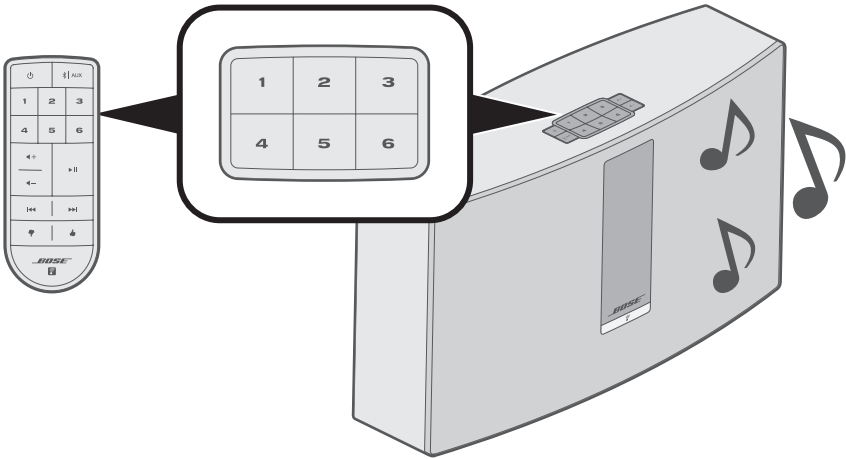

**Note:** For information on using the SoundTouch® app to play your presets, visit [global.Bose.com/Support/ST20III](http://global.Bose.com/Support/ST20III)

## BLUETOOTH® TECHNOLOGY

---

*Bluetooth* wireless technology lets you stream music from *Bluetooth* smartphones, tablets, computers or other devices to your speaker. Before you can stream music from a mobile device, you must connect the mobile device with your speaker.

### Connect your mobile device

---

1. On the speaker's button pad or remote control, press and release  | **AUX** until "Ready to connect" appears on the display.

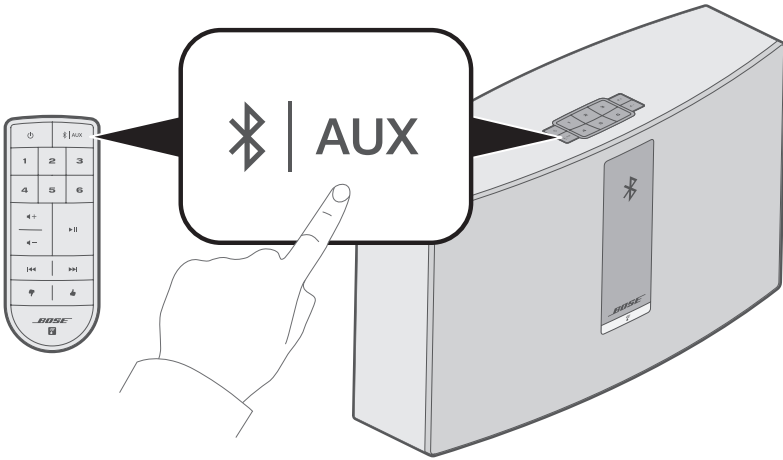

**Tip:** You can also press and hold  | **AUX** for two seconds to connect a device.

2. On your mobile device, turn on the *Bluetooth* feature.

**Tip:** The *Bluetooth* menu is usually found in the Settings menu.

3. Select your SoundTouch® speaker from the mobile device list.



**Note:** Look for the name you entered for your speaker in the SoundTouch® app. If you didn't name your speaker, the default name appears.

Once connected, your SoundTouch® speaker's name appears in the device list.

## Disconnect a mobile device

---

Turn off the *Bluetooth* feature on your mobile device.

## Reconnect a mobile device

---

On the speaker's button pad or remote control, press and release  | **AUX** until a *Bluetooth* pairing message appears on the display.

Your speaker tries to reconnect with the most recently connected mobile device.

**Note:** The mobile device must be within 30 ft. (9 m) of the speaker and powered on.

## Connect using the *Bluetooth* feature on your mobile device

1. On your mobile device, turn on the *Bluetooth* feature.

**Tip:** The *Bluetooth* menu is usually found in the Settings menu.

2. Select your speaker from the mobile device list.

Your speaker powers on and emits a tone.

## Clear the speaker's *Bluetooth* pairing list

---

On the button pad or remote control, press and hold  | **AUX** (10 seconds) until a pairing list cleared message appears on the display.

The speaker is ready to connect to a device (see page 16).

## Use the SoundTouch® app

You can also clear the pairing list using the app.

1. From within the app, select  > **Settings** > **Speaker Settings** and select your speaker.
2. Open the *Bluetooth* menu item and clear the pairing list.

## Connect to the AUX connector

You can connect the audio output of a smartphone, tablet, computer or other type of audio device to your speaker's AUX connector. The AUX connector accepts a 3.5 mm stereo cable plug (not provided).

1. Using a stereo cable, connect your audio device to the **AUX IN**  connector on the speaker.

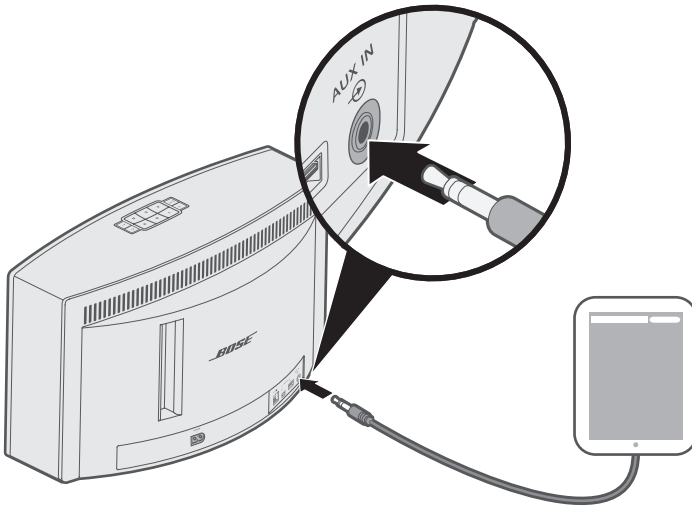

2. On the speaker's button pad or remote control, press and release  | **AUX** until **AUX** appears on the display.
3. Start playing music on the mobile device.

## WI-FI® INDICATOR

---

The front of the speaker has an indicator that shows Wi-Fi status. Lights under the indicator glow according to speaker state.

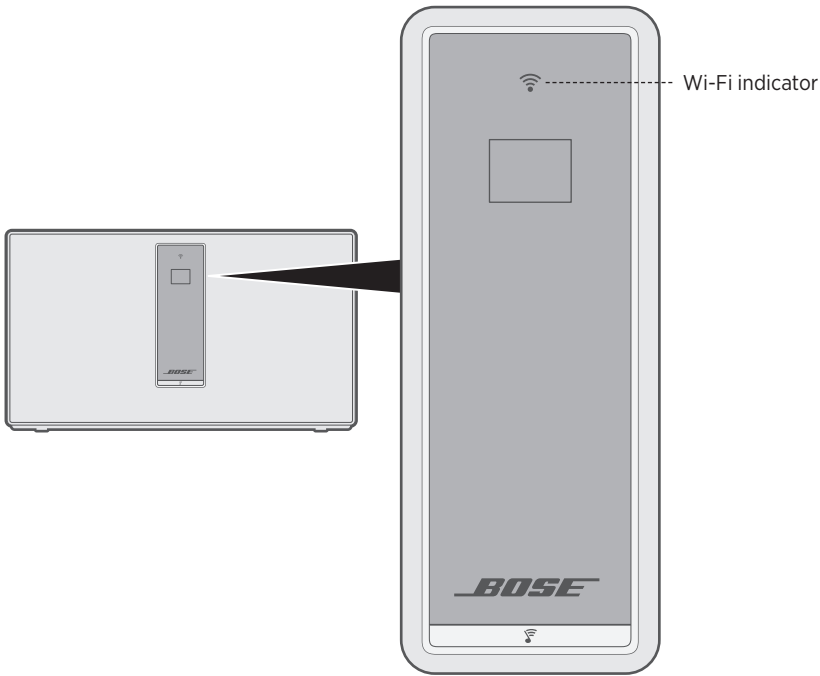









## Wi-Fi status

---

Indicator activity	State
Blinking white	Searching for Wi-Fi network.
Solid white (dim)	Power-saving mode and connected to Wi-Fi network.
Solid white (bright)	Speaker is on and connected to Wi-Fi network.
Solid amber	Speaker is in setup mode.

The display shows speaker information and icons, and may include album or artist.

## Display icons

Display icon	Description
	Searching for Wi-Fi network.
	Volume is being adjusted.
	Music library is playing.
	Multi-room audio is active.
<b>AUX</b>	Auxiliary mode is active.
	<i>Bluetooth</i> source is active.
<b>1 2 3 4 5 6</b>	Preset is selected.
	Skipping forward to the next track.
	Skipping backward to the previous track.
	Audio is paused.
	Audio is stopped.

### Update software

---

The SoundTouch® app alerts you when a software update is available, at which time you can update the software using the app. You can also update software using the button pad.

1. Power on the speaker.
2. On the button pad, press and hold **4** and **◀-** (five seconds).

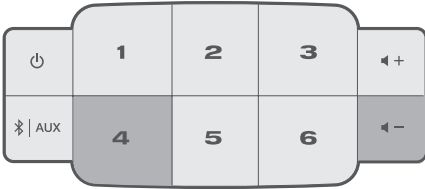

### Disable Wi-Fi capability

---

Disabling Wi-Fi also disables the *Bluetooth* feature.

1. Power on the speaker.
2. On the button pad, press and hold **3** and **◀-** (five seconds).



The Wi-Fi indicator turns off when Wi-Fi is disabled.

### Re-enable Wi-Fi capability

---

Re-enabling Wi-Fi also re-enables the *Bluetooth* feature.

While the speaker is on, press and hold **3** and **◀-** (five seconds).

The Wi-Fi indicator glows when Wi-Fi is enabled.

## Clean the speaker

---

- Clean the surface of your speaker with a soft, dry cloth.
- Do not use any sprays near your speaker. Do not use any solvents, chemicals, or cleaning solutions containing alcohol, ammonia or abrasives.
- Do not allow liquids to spill into any openings.

## Customer service

---

For additional help using your speaker, visit:

**[global.bose.com/Support/ST20III](https://global.bose.com/Support/ST20III)**

## Limited warranty information

---

Your speaker is covered by a limited warranty. Details of the limited warranty are provided on the warranty card in the carton. Please refer to the warranty card for instructions on how to register. Failure to register will not affect your limited warranty rights.

The warranty information provided with this product does not apply in Australia or New Zealand. See our website at [www.bose.com.au/warranty](http://www.bose.com.au/warranty) or [www.bose.co.nz/warranty](http://www.bose.co.nz/warranty) for details of the Australia and New Zealand warranty.

## Technical information

---

### Input power rating

USA/Canada/International: 100-240V ~ 50/60 Hz, 90W

## Replace the remote control battery

**WARNING:** Do not ingest battery, chemical burn hazard. The remote control supplied with this product contains a coin/button cell battery. If the coin/button cell battery is swallowed, it can cause severe internal burns in just in just 2 hours and can lead to death. Keep new and used batteries away from children. If the battery compartment does not close securely, stop using the remote control and keep it away from children. If you think batteries might have been swallowed or placed inside any part of the body, seek immediate medical attention. To avoid risk of explosion, fire or chemical burn, use caution in replacing the battery and replace only with an agency approved (e.g., UL) CR2032 or DL2032 3-volt lithium battery. Properly and promptly dispose of used batteries. Do not recharge, disassemble, heat above 212°F (100°C) or incinerate.

1. Using a coin, turn the battery cover slightly left (counter-clockwise).

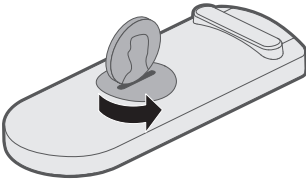

2. Remove the cover. Insert the new battery flat side up, with the + symbol in view.

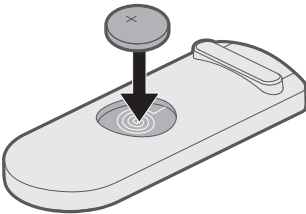

3. Reseat the cover and turn it right (clockwise) to lock into place.

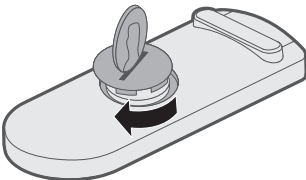



If you experience problems with your speaker:

- Connect your speaker to AC (mains) power.
- Secure all cables.
- Verify the state of the status indicators (see page 20).
- Move your speaker and mobile device away from possible interference (wireless routers, cordless phones, televisions, microwaves, etc.).
- Move your speaker within the recommended range of your wireless router or mobile device for proper operation.

If you could not resolve your issue, see the table below to identify symptoms and solutions to common problems. If you are unable to resolve your issue, contact Bose customer service.

## Common solutions

The following table lists symptoms and possible solutions to common problems.

Symptom	Solution
Speaker is unresponsive during setup	<p>If the Wi-Fi indicator or display is off:</p> <ul style="list-style-type: none"> <li>• On the speaker's button pad, press and hold  for two seconds, then release.</li> <li>• When the speaker powers on, resume setup.</li> </ul>
Pressing the power button does not power on the speaker	<p>Your speaker may be in standby mode. To wake the speaker, on the speaker's button pad, press and hold  for two seconds, then release.</p>
Cannot complete network setup	<ul style="list-style-type: none"> <li>• Select correct network name and enter password.</li> <li>• Connect the device and speaker to the same Wi-Fi network.</li> <li>• Place your speaker within range of the router.</li> <li>• Enable Wi-Fi on the device (mobile or computer) you are using for setup.</li> <li>• Close other open applications.</li> <li>• If using a computer for setup, check firewall settings to make sure that the SoundTouch® app and SoundTouch® Music Server are allowed programs.</li> <li>• Restart your mobile device or computer and your router.</li> <li>• Reset your speaker (see page 27).</li> <li>• If your router supports both 2.4GHz and 5GHz bands, make sure both the device (mobile or computer) and speaker are connecting to the same band.</li> <li>• Uninstall the app, reset your speaker (see page 27), and restart setup.</li> </ul>

## TROUBLESHOOTING

---

Symptom	Solution
Cannot connect to network	If your network information has changed or to connect your speaker to another network, see page 13.
Intermittent or no audio	<ul style="list-style-type: none"><li>• Stop other audio or video streaming applications.</li><li>• Unmute or increase the volume on your speaker and mobile device.</li><li>• Unplug the power cord; reconnect after one minute.</li><li>• Restart your mobile device or computer and your router.</li></ul>
Cannot play <i>Bluetooth</i> audio	<ul style="list-style-type: none"><li>• Set up the SoundTouch® app first and perform all updates.</li><li>• Connect a mobile device (see page 16).</li><li>• Clear your speaker pairing list (see page 18).</li><li>• Try pairing a different mobile device.</li></ul> On your mobile device: <ul style="list-style-type: none"><li>• Disable and re-enable the <i>Bluetooth</i> feature.</li><li>• Remove your speaker from the <i>Bluetooth</i> menu. Connect again.</li><li>• Refer to your mobile device's documentation.</li><li>• See "Intermittent or no audio."</li></ul>
Bass is too heavy or low	Adjust the bass level of your speaker in the app: <ol style="list-style-type: none"><li>1. From within the app, select  &gt; <b>Settings</b> &gt; <b>Speaker Settings</b> and select your speaker.</li><li>2. Adjust the bass level of your speaker.</li></ol>

## Reset your speaker

Factory reset clears all source, volume, and network settings and returns the speaker to original factory settings.

1. Power on the speaker.
2. On the button pad, press and hold **1** and **◀-** (10 seconds).

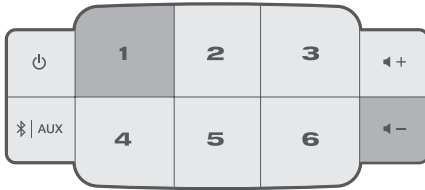

The speaker restarts, and the Wi-Fi indicator glows amber (setup mode).

3. Open the SoundTouch® app on your smartphone or tablet and add the speaker to your network (see page 13).

## Get diagnostic information

Get detailed information, such as MAC address and network information, serial number and software version.

1. On the button pad, press and hold **5** and **◀-** until system information appears on the display.

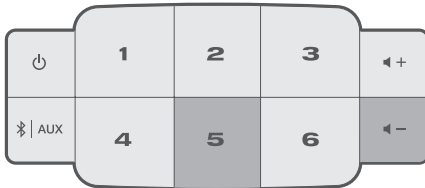

2. Press **◀+** or **◀-** to scroll through speaker information.

## Set up your speaker using a computer

---

You can set up your speaker using a computer rather than a smartphone or tablet.

### Before you begin

- Position your speaker next to your computer.
- Make sure your computer is on your Wi-Fi network.
- Obtain a USB A to USB Micro B cable (not provided).

#### Notes:

- A USB A to USB Micro B cable is commonly used for charging mobile devices. You can also purchase this at your local electronics store. If you don't have this cable, contact Bose customer service.
- The USB connector on the back of your speaker is for computer setup only. The USB connector is not designed to charge smartphones, tablets, similar devices or the speaker itself.

### Computer setup

During setup, the app prompts you to temporarily connect the USB cable from the computer to your speaker. Do not connect the USB cable until the app instructs you to do so.

1. Plug the power cord into an AC (mains) power outlet.
2. On your computer, open a browser and go to:  
[global.Bose.com/Support/ST20III](http://global.Bose.com/Support/ST20III)

**Tip:** Use the computer where your music library is stored.

3. Download and run the SoundTouch® app.  
The app guides you through setup.
4. After setup is complete, disconnect the USB cable from your computer and from your speaker. Move your speaker to its permanent location.





***BOSE***

©2017 Bose Corporation, The Mountain,  
Framingham, MA 01701-9168 USA  
AM801086 Rev. 00