

**Whirlpool**

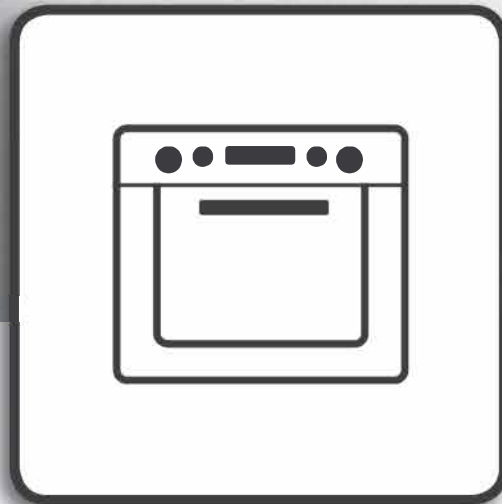

## **Health & Safety, Use & Care, Installation Guide and Online Warranty Registration Information**

**Model: W3 OMK35HR0BA  
W3 OMK55HR0BC  
W3 OMK55HR0XC**



**[www.whirlpool.com.au](http://www.whirlpool.com.au)  
[www.whirlpool.co.nz](http://www.whirlpool.co.nz)  
[www.whirlpool.com.sg](http://www.whirlpool.com.sg)**



## BUILT IN OVEN USE AND CARE GUIDE

Dear user,

Thank you for choosing our products. We are sure you will find your new appliance a pleasure to use. Before you use the appliance, we recommend that you read through these instructions carefully and retain them for future reference. Design and specification may change due to product development, no prior notice will be given.

### Table of Contents

<b>IMPORTANT SAFETY INSTRUCTIONS .....</b>	<b>3</b>
<b>INSTALLATIONS .....</b>	<b>7</b>
<b>OPERATING INSTRUCTIONS .....</b>	<b>10</b>
<b>ACCESSORIES .....</b>	<b>12</b>
<b>FIRST TIME USE.....</b>	<b>13</b>
<b>FUNCTIONS &amp; DAILY USE.....</b>	<b>13</b>
<b>COOKING TABLE .....</b>	<b>17</b>
<b>CLEANING &amp; MAINTENANCE .....</b>	<b>18</b>
<b>TROUBLESHOOTING.....</b>	<b>20</b>
<b>AFTER-SALES SERVICE .....</b>	<b>21</b>



---

# IMPORTANT SAFETY INSTRUCTIONS

---

## SAFETY INSTRUCTIONS TO BE READ AND OBSERVED

Before using the appliance, read these safety instructions. Keep them nearby for future reference. These instructions and the appliance itself provide important safety warnings, to be observed at all times. The manufacturer declines any liability for failure to observe these safety instructions, for inappropriate use of the appliance or incorrect setting of controls.

⚠ To maintain the efficiency and safety of this appliance, only call the authorised service centers and always use original spare parts.

⚠ Toddlers (0-3 years) should be kept away from the appliance. Young children (3-8 years) should be kept away from the appliance unless continuously supervised. Children above 8 years old and people with reduced physical, sensory or mental capabilities or lack of experience and knowledge can use this appliance only if they are supervised or have been given instructions on safe use and understand the hazards involved. Children must not play with the appliance. Cleaning and user maintenance must not be carried out by children without supervision.

⚠ **WARNING:** The appliance and its accessible parts become hot during use. Care should be taken to avoid touching heating elements. Children less than 8 years of age must be kept away unless continuously supervised.

⚠ Never leave the appliance unattended during food drying. If the appliance is suitable for probe usage, only use a temperature probe recommended for this oven.

⚠ Keep clothes or other flammable materials away from the appliance, until all the components have cooled down completely. Always be vigilant when cooking foods rich in fat, oil or when adding alcoholic beverages. Use oven gloves to remove pans and accessories. At the end of cooking, open the door with caution, allowing hot air or steam to escape gradually before accessing the cavity so as to prevent burns. Do not obstruct hot air vents at the front of the oven.

⚠ Exercise caution when the oven door is in the open or down position, to avoid hitting the door.

⚠ When handling the appliance, always use the provided handles recessed into the sides of the oven to prevent harming people or damaging the appliance itself.

⚠ Heat will be generated when it is working. Caution must be exercised to avoid touching the heating element.

⚠ Use oven gloves to place cookware in the oven or when removing it.

⚠ Always grip the oven door handle in the center as the extremities of the same may be hot due to any hot air leaks

⚠ Make sure the knobs are in the **0** position when the appliance is not in use.

## PERMITTED USE

⚠ **CAUTION:** The appliance is not intended to be operated by means of an external switching device, such as a timer, or separate remote controlled system. This appliance is intended to be used in household and similar applications such as: staff kitchen areas in shops, offices and other working environments; farm houses; by clients in hotels, motels, bed & breakfast and other residential environments.

⚠ No other use is permitted (e.g. heating rooms). This appliance is not for professional use. Do not use the appliance outdoors.

⚠ Do not store explosive or flammable substances (e.g. gasoline or aerosol cans) inside or near the appliance.

## INSTALLATION

⚠ The appliance must be handled and installed by two or more persons. Use protective gloves to unpack and install.

⚠ Installation, including water supply (if any), electrical connections and repairs must be carried out by a qualified technician. Do not repair or replace any part of the appliance unless specifically stated in the user manual. Keep children away from the installation site. After unpacking the appliance, make sure that it has not been damaged during transport. In the event of problems, contact the dealer or your nearest After-sales Service. Once installed, packaging waste (plastic, styrofoam parts etc.) must be stored out of reach of children. The appliance must be disconnected from the power supply before any installation operation. During installation, make sure the appliance does not damage the power cable preventing catching fire or electric shock. Only activate the appliance when the installation has been completed.

⚠ Carry out all cabinet cutting operations before fitting the appliance and remove all wood chips and sawdust. Do not obstruct the minimum gap between the worktop and the upper edge of the oven. Do not remove the oven from its polystyrene foam base until the time of installation.

⚠ After installation, the bottom of the appliance must no longer be accessible.

⚠ Do not install the appliance behind a decorative door.

## ELECTRICAL WARNINGS

⚠ The rating plate is on the front edge of the oven (visible when the door is open).

⚠ It must be possible to disconnect the appliance from the power supply by unplugging it if the plug is accessible, or by a multi-pole switch installed upstream of the socket in accordance with the wiring rules and the appliance must be earthed in conformity with national electrical safety standards.

⚠ Do not use extension leads, multiple sockets or adapters. The electrical components must not be accessible to the user after installation. Do not use the appliance when you are wet or barefoot. Do not operate this appliance if it has a damaged power cable or plug, if it is not working properly, or if it has been damaged or dropped.

⚠ If the supply cord is damaged, it must be replaced with an identical one by the manufacturer, its service agent or similarly qualified persons in order to avoid a hazard and electric shock. In case of replacement of power cable, contact an authorised service centre.

## CLEANING AND MAINTENANCE

⚠ **WARNING:** Ensure that the appliance is switched off and disconnected from the power supply before performing any maintenance operation; never use steam cleaning equipment - risk of electric shock.

⚠ Do not use harsh abrasive cleaners or metal scrapers to clean the door glass since they can scratch the surface, which may result in shattering of the glass.

⚠ Ensure the appliance is cooled down before any cleaning or maintenance to prevent burns.

⚠ **WARNING:** Switch off the appliance before replacing the lamp.

## TECHNICAL SPECIFICATIONS

Model	W3 OMK35HR0BA
Supply Voltage & Frequency	220-240V/50-60Hz
Total Capacity	82L
Input Power	1800-2200W
Net Weight (kg)	29.5
Gross Weight (kg)	35.4
Product Dimensions (mm)	594 (W) x 594 (H) x 519 (D)
Cut-out Dimensions (mm)	W 565-595mm x H 595mm x D 570mm (Flush Fit) W 565-595mm x H 580-585mm x D 505-570mm (Proud Fit)

Model	W3 OMK55HR0BC / W3 OMK55HR0XC
Supply Voltage & Frequency	220-240V/50-60Hz
Total Capacity	82L
Input Power	3000-3600W
Net Weight (kg)	29.5
Gross Weight (kg)	35.4
Product Dimensions (mm)	594 (W) x 594 (H) x 519 (D)
Cut-out Dimensions (mm)	W 565-595mm x H 595mm x D 570mm (Flush Fit) W 565-595mm x H 580-585mm x D 505-570mm (Proud Fit)

Technical specifications can be changed without prior notice to improve product quality.

The values provided with the appliance or its accompanying documents are laboratory readings in accordance with the respective standards. These values may differ depending on the use and ambient conditions.

# INSTALLATIONS

Only a qualified person in compliance with the instructions provided must install the appliance. The manufacturer declines all responsibility for improper installation, which may harm people and animals and damage property.

**IMPORTANT:** - The power supply to the appliance must be cut off before any adjustments or maintenance work is done on it. Air duct is required for ventilation.

## INSTALLATION OF BUILT-IN OVEN

In order to ensure that the built-in appliance functions properly, the cabinet containing it must be appropriate. The figure below gives the dimensions of the cut-out for installation under the counter or in a wall cabinet unit.

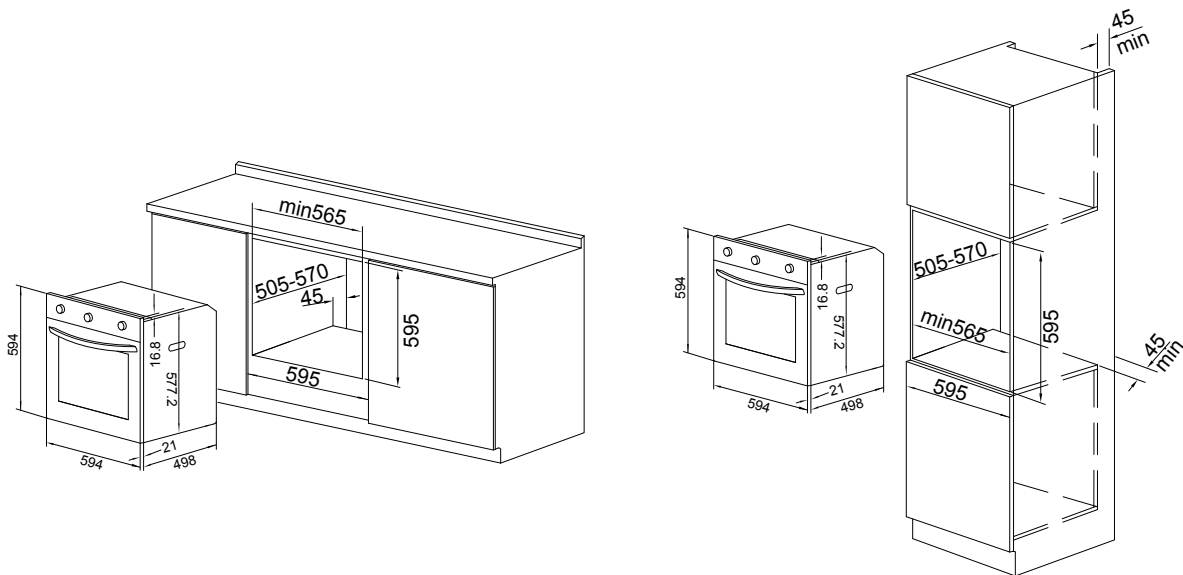

### Installation in compliance with the consumption declaration

In order to ensure adequate ventilation, the back panel of the cabinet unit must be removed. Installing the oven so that it rests on two strips of wood is preferable. If the oven rests on a continuous, flat surface, there must be an aperture of at least 45×560mm.

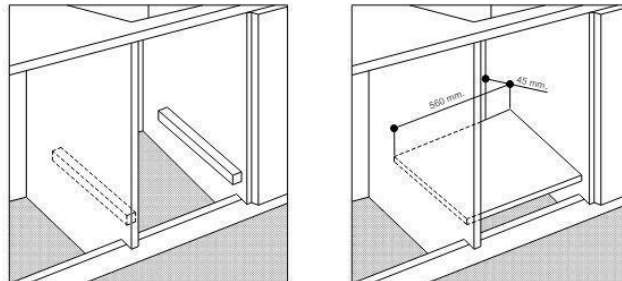

The panels of the adjacent cabinets must be made of heat-resistant material. In particular, cabinets with a veneer exterior must be assembled with glues which can withstand temperatures of up to 100°C.

In compliance with current safety standards, contact with the electrical parts of the oven must not be possible once it has been installed.

All parts, which ensure the safe operation of the appliance, must be removable only with the aid of a tool. To fasten the oven to the cabinet, open the door of the oven and attach it by inserting the 4 wooden screws into the 4 holes located on the perimeter of the frame.

## **ELECTRICAL CONNECTION**

Those ovens equipped with a three-pole power supply cable are designed to operate with an alternating current. The wire for earthing the appliance is yellow-green in color.

### **CONNECTING THE SUPPLY CABLE TO THE MAINS**

W3 OMK35HR0BA Only The appliance includes a power cord and plug for easy installation. Ensure the plug is accessible and connected to a 10A power outlet. If the appliance is not supplied with a plug, a qualified technician must connect the cable directly to the mains by installing an omni polar circuit breaker with a minimum contact opening of 3mm between the appliance and the mains. The omni polar circuit breaker should be sized according to the load and should comply with current regulations (the earthwire should not be interrupted by the circuit breaker).



The supply cable should be positioned so that it does not reach a temperature of more than 50°C with respect to the room temperature, anywhere along its length, or protected by insulation sleeping having an appropriate rating.

Before making the connection, check that:

- The electrical safety of this appliance can only be guaranteed if the cooker is correctly and efficiently earthed, in compliance with regulations on electrical safety. Always ensure that the earthing is efficient; if you have any doubts call in a qualified technician to check the system. The manufacturer declines all responsibility for damage resulting from a system which has not been earthed.
- Before plugging the appliance into the mains, check that the specifications indicated on the rating label (on the appliance and /or packaging) correspond to those of the electrical mains system of your home.
- Check that the electrical capacity of the system and sockets will support the maximum power of the appliance, as indicated on the data plate. If you have any doubts, call in a qualified technician.
- If the socket and appliance plug are not compatible, have the socket replaced with a suitable model by a qualified technician. The latter, in particular, will also have to ensure that the cross section of the socket cables are suitable for the power absorbed by the appliance. The use of adapters, multiple sockets and /or extensions, is not recommended. If their use cannot be avoided, remember to use only single or multiple adapters and extensions which comply with current safety regulations. In these cases,

never exceed maximum current capacity indicated on the single adapter or extension and the maximum power indicated on the multiple adapter. **The plug and socket must be easily accessible.**

## ENVIRONMENTALLY-FRIENDLY DISPOSAL

- The packing box may be fully recycled as confirmed by the recycling symbol. Follow local disposal regulations. Keep potential hazardous packaging (plastic bags, polystyrene, etc.) out of the reach of children. 
- This appliance is marked according to the European directive 2012/19/EU on Waste Electrical and Electronic Equipment (WEEE). By ensuring this product is disposed of correctly, you will help prevent potential negative consequences for the environment and human health, which could otherwise be caused by inappropriate waste handling of this product.
- The symbol on the product, or on the documents accompanying the product, indicates that this appliance may not be treated as household waste. Instead, it shall be handed over to the applicable collection point for the recycling of electrical and electronic equipment. 
- Disposal must be carried out in accordance with local environmental regulations for waste disposal.
- For more detailed information about treatment, recovery and recycling of this product, please contact your local city office, your household waste disposal service or the shop where you purchase the product.
- Before scrapping, cut off the mains cord so that the appliance cannot be connected to the mains.

---

# OPERATING INSTRUCTIONS

---

**MODEL: W3 OMK35HR0BA**  
**PRODUCT DESCRIPTION**

---

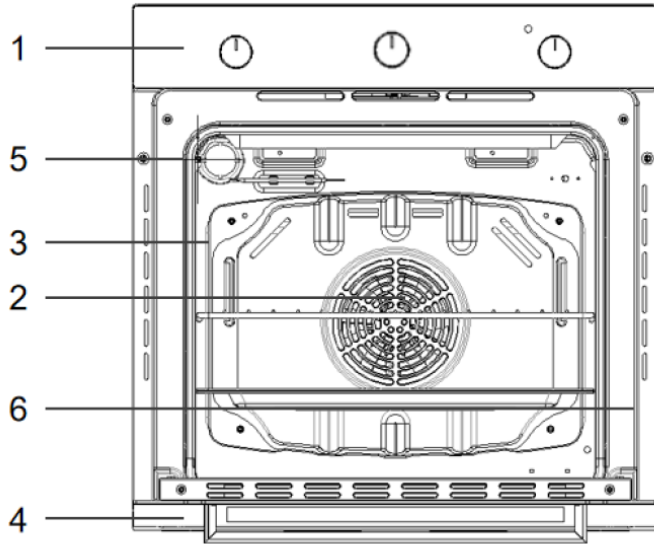

- 1. Control Panel
- 2. Circulation Fan
- 3. Shelf Guides
- 4. Door
- 5. Lamp
- 6. Rating Label  
(Do Not Remove)

---

## CONTROL PANEL DESCRIPTION

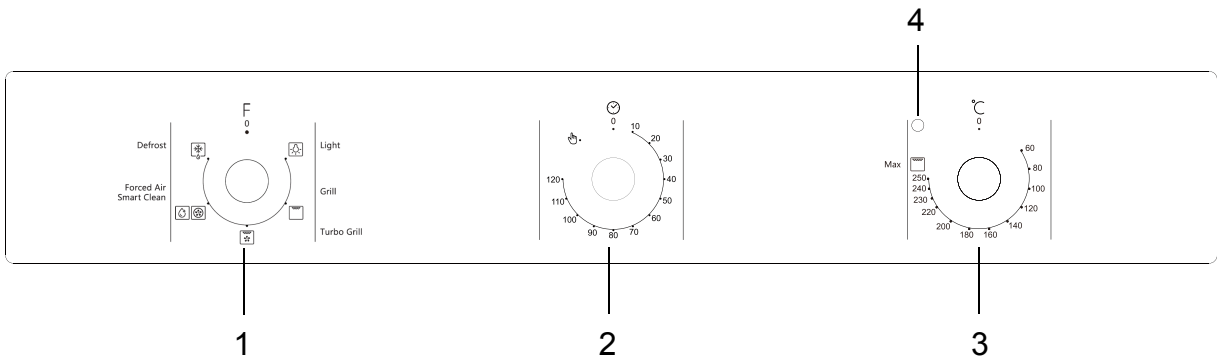

- 1. SELECTION KNOB**  
For switching the oven on by selecting a function. Turn to the position 0 to switch the oven off.
- 2. TIMER KNOB**  
Useful as a timer.
- 3. THERMOSTAT KNOB**  
Turn to select a desired temperature, activating the selected function.

- 4. LED THERMOSTAT/PREHEATING**  
Switches on during the heating process. Switches off once the desired temperature is reached.

Please note: Placing the food in the oven before preheating has finished may have an adverse effect on the final cooking result.

**MODEL: W3 OMK55HR0BC , W3 OMK55HR0XC**  
**PRODUCT DESCRIPTION**

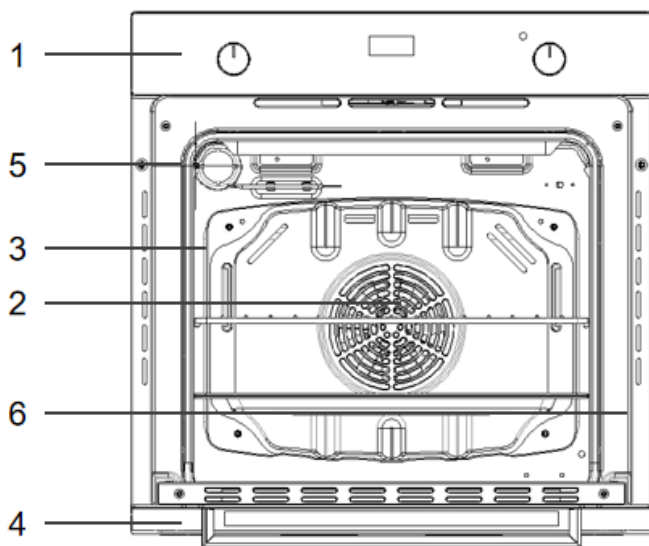

- 1. Control Panel
- 2. Circulation Fan
- 3. Shelf Guides
- 4. Door
- 5. Lamp
- 6. Rating Label  
(Do Not Remove)

**CONTROL PANEL DESCRIPTION**

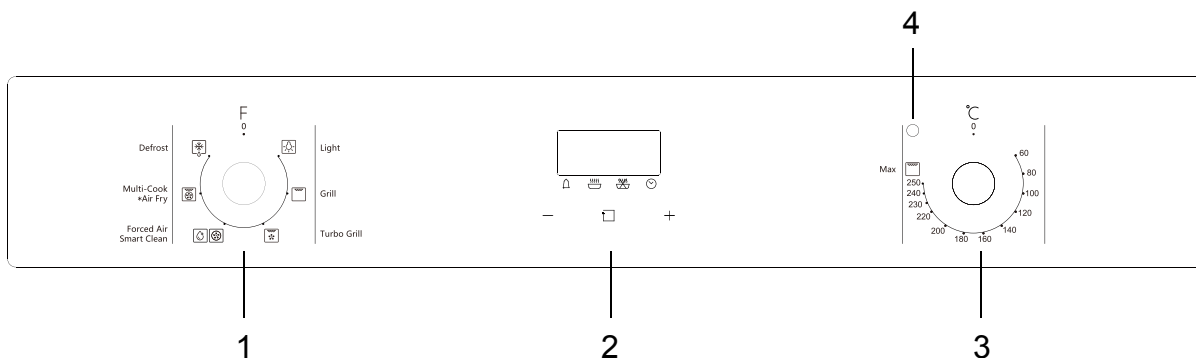

- 1. SELECTION KNOB**  
For switching the oven on by selecting a function. Turn to the position 0 to switch the oven off.
- 2. TOUCH CONTROL DIGITAL TIMER**
- 3. THERMOSTAT KNOB**  
Turn to select a desired temperature, activating the selected function.

- 4. LED THERMOSTAT**  
Switches on during the heating process. Switches off once the desired temperature is reached.
- Please note: Placing the food in the oven before preheating has finished may have an adverse effect on the final cooking result.

## TOUCH CONTROL DIGITAL TIMER

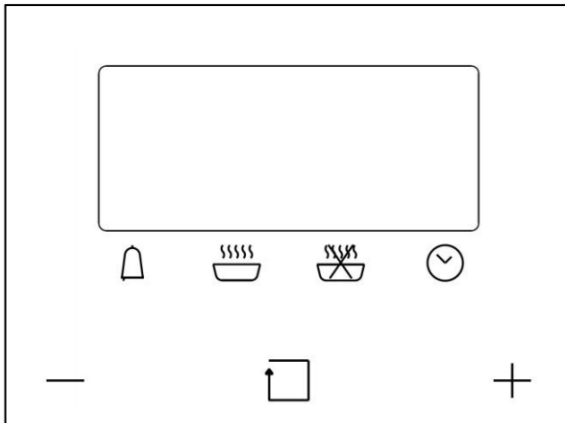

Button Functions		
—	Decrease Time	Touch Button
+	Increase Time	Touch Button
□↻	Timer Mode	Touch Button
🔔	Timer	Display Icon
🍲	Set Cooking Time (Amount of time to cook)	Display Icon
🍲	End Cooking Time (End time for cooking)	Display Icon
🕒	Set the time	Display Icon

## ACCESSORIES

The number and type of accessories may vary depending on which model is purchased. Other accessories that are not supplied can be purchased separately from the After-sales Service.



**WIRE SHELF** Use to cook food or as a support for pans, cake tins and other ovenproof items of cookware.

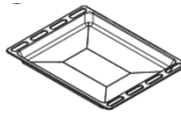

**BAKING TRAY\*** Use for cooking all bread and pastry products, but also for roasts, fish en papillote, etc.

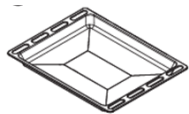

**DEEP TRAY\*** Use as an oven tray for cooking meat, fish, vegetables, focaccia, etc or position underneath the wire rack to collect cooking juice.



**AIR FRY BASKET\*** Use the Air Fry basket for frozen food such as chips, wedges or chicken nuggets.

\* Available only on certain models

The number and the type of accessories may vary depending on which model is purchased.

Other accessories may be purchased separately; for orders and information contact the after sales service.

---

## FIRST TIME USE

---

### SET THE TIME (\*W3 OMK55HR0BC & W3 OMK55HR0XC only)

When the power is connected, the screen displays 12:00 and the bar above the  symbol flashes. Use + or - button to set the time. The time will be locked in after 5 seconds.

### HEAT THE OVEN

A new oven may release odours that have been left behind during manufacturing: this is completely normal. Therefore, before starting to cook food, we recommend heating the empty oven in order to remove any possible odours. Remove any cardboard or transparent film from the oven and remove any accessories from inside it. Heat the oven to 250°C for about half an hour. The oven must be empty during this time. Follow the instructions for setting the function correctly.





Please note: We recommend ventilating the room after using the appliance for the first time.





---

## FUNCTIONS & DAILY USE

---

### FUNCTIONS

	<b>OFF</b> For switching off the oven.
	<b>LIGHT</b> For switching on the light in the compartment.
	<b>Grill</b> Uses radiant heat from powerful upper element. Select a temperature between 60°C and max. Recommended for grilling tender cuts of meat, steak, chops, sausages, fish, cheese toasts. Preheat the grill for 3 mins to get the best results. Slide the grill dish into either of the 2 spaces within the upper pairs of support rails.
	<b>Turbo Grill</b> Uses top central heating and fan. Select a temperature between 60°C and 200°C Grill element turns on and off to maintain the set temperature while the fan circulates the heat air. Keep the door closed to ensure food is fully cooked. Recommended for large cuts of meat. Put the food on the 2nd or 3rd rack from the bottom. Put the deep tray on the lowest shelf to collect the oil or juice. It is not required to turn the food over when using this mode.
	<b>Forced Air</b> Uses the heating element from the rear and the fan to ensure delicate even

	<p>heat distribution throughout the oven.          Select a temperature between 60°C and 250°C.          Ideal for baking and cooking delicate food on 3 shelves at the same time.          Recommended for cakes that need to rise, cream puffs, sweet and savory biscuits, savory puffs, swiss rolls, small portions of vegetables au gratin, etc.</p>
	<p><b>Multi-Cook</b>          Uses the top and circle heating elements together with the fan.          Select a temperature between 60°C and max.          Able to cook various dishes at the same time with the same cooking temperatures. A maximum of 2 racks can be used at the same time.          Recommended for dishes requiring a gratin finish or those requiring prolonged cooking times (eg. lasagna, baked pasta, roast chicken, potatoes, etc.), cooking fish, vegetable-based side dishes and baking leavened cakes.</p>
	<p><b>Air Fry*</b> (W3 OMK55HR0BC &amp; W3 OMK55HR0XC only)          The Air Fry function allows you to cook many types of food with less oil, resulting in pleasantly crispy and healthy dishes. The oven cavity heats up while the fan circulates hot air. The Air Fry function combined with the Air Fry basket are ideal for cooking your favourite frozen foods such as chips, wedges or chicken nuggets without any oil.</p> <p>For best results, place the food in a single layer on the Air Fry basket, avoiding any overlap. Place the tray on the wire shelf and insert a baking tray at a lower level to collect any crumbs or drips. Avoid using multiple trays to ensure even cooking.</p>
	<p><b>Defrost</b>          When set to 'Defrost' mode, the fan located at the back of the oven circulates room temperature air around the food. This is recommended for the defrosting of all types of food, but in particular for delicate types of food which do not require heat, for example: ice cream cakes, cream or custard desserts, fruit cakes, etc. By using "Defrost" mode, the defrosting time is approximately halved</p>
	<p><b>Smart Clean</b>          The action of steam released during this special cleaning cycle allows dirt and food residues to be removed with ease.          To activate "Smart Clean" cleaning function, pour 150ml of drinking water into the bottom of the oven then turn the selector knob to , icon and the thermostat knob between 220°C and 250°C. Recommended cleaning time between 20-30 minutes.</p>

## DAILY USE

### 1. SELECT A FUNCTION

To select a function, turn the selection knob to the symbol of the function you require. The oven light switches on.

### 2. ACTIVATE A FUNCTION

After turning the selection knob, turn the thermostat knob clockwise to the required temperature.

At the end of cooking, to switch off the oven, turn the selection knob and the thermostat knob to **0**.

### 3. PREHEATING

Once the function has been activated, the thermostat LED light will switch on signalling that the preheating process has begun.

At the end of this process, the thermostat LED light switches off indicating that the oven has reached the set temperature. At this point, the oven is ready to place the food inside and proceed with cooking.

Please note: Placing the food in the oven before preheating has finished may have an adverse effect on the final cooking result.

### 4. SETTING THE TIMER

#### For W3 OMK35HR0BA (Mechanical Timer)

The timer knob can be used to set a cooking time of between 10 and 120 minutes. To set cooking time, after selecting the required cooking function, turn the knob right round in a clockwise direction to the desired cooking duration. The temperature knob can be used to set the temperature between 60 and 250°C. At the end of the set cooking time the oven switches off and the timer knob goes back to OFF position.

**IMPORTANT:** when the timer knob is positioned at **0** the oven will not switch on. To switch the oven on, set the knob to “hand icon” symbol or set a cooking time.

#### For W3 OMK55HR0BC & W3 OMK55HR0XC (Touch Timer)

This option does not interrupt any program cooking but allows you to use the display as a timer, either while a function is active or when the oven is off.

Keep pressing  until  above square starts flashing on the display.



Use + or - to set the time you require. An audible signal will sound once the timer has finished counting down the selected time.

Notes:



★ Maximum duration: 23 hours and 59 minutes

★ To cancel the time, to adjust the timer to be 0



### 5. PROGRAMMING COOKING (W3 OMK55HR0BC & W3 OMK55HR0XC only)

You will need to select a function before you can start programming cooking.



## DURATION

Keep pressing “” until “” above “” start flashing on the display.



Use + or - to set the cooking time you require. Activate the function by turning the thermostat knob to the temperature you require. “” above “” will flash to indicate the cooking has started. An audible signal will sound, and the display will indicate that cooking is complete.

## PROGRAMMING THE END COOKING TIME

After a cooking duration has been set, starting the function can be delayed by programming its end time, press “” until “” above “” starts flashing on the display.

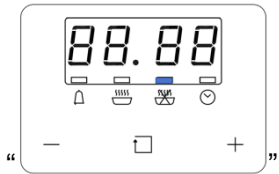

































Use + or - to set the time you want cooking to end. Activate the function by turning the thermostat knob to the temperature you require.

## END OF COOKING

An audible signal will sound, and the display will indicate that the function has finished. Turn the selection knob to **0** to switch the oven off.





## COOKING TABLE

RECIPE	FUNCTION	WEIGHT (KG)	PREHEAT (MIN)	TEMPERATURE (°C)	DURATION (MIN)	LEVEL
Pizza (on 2 racks)		1	15	220	15-20	2-4
Lasagna		1	10	200	30-35	3
Lamb		1	10	180	50-60	2
Roast Chicken+Potatoes		1	10	180	60-75	2-4
Mackerel		1	10	180	30-35	2
			5	Max	15-20	4
Plum Cake		1	10	170	40-50	2
Cream Puffs (on 2 racks)		0.5	10	190	20-25	2-4
Biscuits (on 2 racks)		0.5	10	180	10-15	2-4
Sponge Cake (on 1 rack)		0.5	10	170	15-20	2
Sponge Cake (on 2 racks)		1.0	10	170	20-25	2-4
Savory Pies		1.5	15	200	25-30	3
Soles and Cuttlefish		1	5	Max	8-10	4
Squid and Prawn Kebabs		1	5	Max	6-8	4
Cod Fillet		1	5	Max	10	4
Grilled Vegetables		1	5	Max	10-15	3/4
Veal Steak		1	5	Max	15-20	4
Cutlets		1	5	Max	15-20	4
Hamburgers		1	5	Max	7-10	4

Toasted Sandwiches		-	5	Max	2-3	4
Grilled Chicken		1.5	5	200	55-60	3
Cuttlefish		1.5	5	200	30-35	3
Tarts		0.5	15	180	20-30	3
Fruit Cakes		1	15	180	40-45	2/3
Fruitcake		0.7	15	180	40-50	3
Sponge Cake		0.5	15	160	25-30	3
Stuffed Pancakes (on 2 racks)		1.2	15	200	30-35	2-4
Small Cakes (on 2 racks)		0.6	15	190	20-25	2-4
Cheese Puffs (on 2 racks)		0.4	15	210	15-20	2-4
Cream Puffs (on 3 racks)		0.7	15	180	20-25	1-3-5
Biscuits (on 3 racks)		0.7	15	180	20-25	1-3-5
Meringues (on 3 racks)		0.5	15	90	180	1-3-5

\*Cooking durations are approximate and may vary according to personal taste.

\*When cooking with Grill or Turbo Grill, a deep tray must always be placed on the 1st rack from the bottom.

FUNCTIONS				
	Multi-Cook	Grill	Turbo Grill	Forced Air

## CLEANING & MAINTENANCE

Make sure the oven has cooled down before carrying out any maintenance or cleaning. Do not use steam cleaners. Do not use wire wool, abrasive scourers or abrasive/corrosive cleaning agents, as these could damage the surfaces of the appliance. Wear protective gloves. The oven must be disconnected from the mains before carrying out any maintenance work.

### EXTERIOR SURFACES

Clean surfaces with a damp microfiber cloth. If they are very dirty, add a few drops of pH - neutral detergent. Finish off with a dry cloth. Do not use corrosive or abrasive detergents. If any of these products inadvertently comes into contact with the surfaces of the appliance, clean immediately with a damp microfiber cloth.

### INTERIOR SURFACES

After every use, leave the oven to cool and then clean it, preferably while it is still warm, to remove any deposits or stains caused by food residues. To dry any condensation that has formed as a result of cooking foods with a high water content, leave the oven to cool completely and then wipe it with a cloth or sponge. Activate the “Smart Clean” function for optimum cleaning of internal surfaces. Clean the glass in the door with a suitable liquid detergent.

### ACCESSORIES

Soak the accessories in a washing-up liquid solution after use, handling them with oven gloves if they are still hot. Food residues can be removed using a washing-up brush or a sponge.

### REMOVING AND REFITTING THE DOOR

To remove the door, open it fully (Fig. 1). Open the lever A completely on the left and right hinges (Fig 2). Hold the door as shown in Fig. 3. Gently close the door (Fig. 3) until left and right hinge levers A are hooked to part B of the door (Fig 4). Withdraw the hinge hooks in the direction Arrow C in Fig 4.

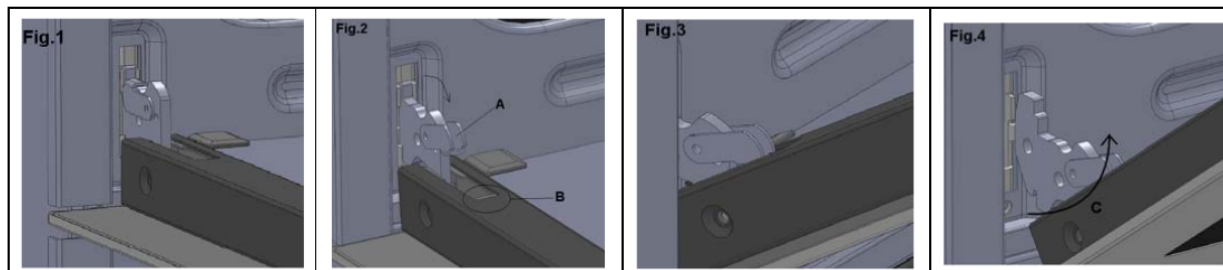

Put the door to one side, resting it on a soft surface. Clean the glass with an appropriate cleaner. Dry thoroughly. To refit the door, repeat the steps above in reverse order.

### REPLACING THE LAMP

Disconnect the oven from the power supply, remove the cover from the light, replace the bulb and fit the cover back on the light. Reconnect the oven to the power supply. Do not use the oven until the light cover has been refitted.

Please note: Only use 25W/220-240V, G9 type. The bulb used in the product is specifically designed for domestic appliances and is not suitable for general room lighting within the home. Light bulbs are available from our After-sales Service.

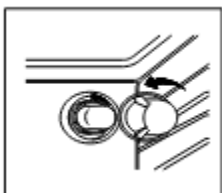

## TROUBLESHOOTING

What to do if...	Solutions
Pastry is too dry	Increase the temperature by 10°C and reduce the cooking time.
Pastry dropped	Use less liquid or lower the temperature by 10°C.
Pastry is too dark on top	Place it on a lower rack, lower the temperature, and increase the cooking time.
Cooked well on the inside but sticky on the outside	Use less liquid, lower the temperature, and increase the cooking time.
Pastry sticks to the pan	Grease the pan well and sprinkle it with a dusting of flour or use greaseproof paper.
I used more than one level using Forced Air mode and they do not cook at the same time.	Use a lower temperature setting. It is not necessary to remove the food from all the racks at the same time.
Preheating time is too long.	Use Multi-Cook mode to reach the desired temperature as quickly as possible in order to save energy. Once the food is placed in the oven, select the most appropriate cooking mode.

---

## AFTER-SALES SERVICE

---

To receive complete assistance, please register your product in your local market. Call the number shown on the warranty booklet or follow the website's instructions on:

Australia: [www.whirlpool.com.au](http://www.whirlpool.com.au)

New Zealand: [www.whirlpool.co.nz](http://www.whirlpool.co.nz)

Philippines: [www.whirlpool.com.ph](http://www.whirlpool.com.ph)

Singapore: [www.whirlpool.com.sg](http://www.whirlpool.com.sg)

Taiwan: [www.whirlpool.com.tw](http://www.whirlpool.com.tw)

When contacting our Client After-sales service, always specify:

- A brief description of fault;
- The type and exact model of the appliance;
- The serial number (on the rating plate located at the front edge of the oven; visible when the door is open);
- Your full address;
- Your telephone number

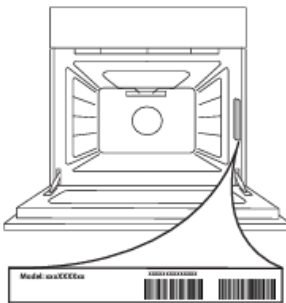

## REGISTER YOUR PRODUCT ONLINE

### For Australia Market



Scan QR Code to visit  
[www.whirlpool.com.au](http://www.whirlpool.com.au)  
to register your product warranty online.

This QR Code is only applicable to Australia.  
You can download the user manual by

- Visiting our website [www.whirlpool.com.au](http://www.whirlpool.com.au)
- Contacting our Customer Service Center at 1300 363 344

### For New Zealand Market



Scan QR Code to visit  
[www.whirlpool.co.nz](http://www.whirlpool.co.nz)  
to register your product warranty online.

This QR Code is only applicable to New Zealand.  
You can download the user manual by

- Visiting our website [www.whirlpool.co.nz](http://www.whirlpool.co.nz)
- Contacting our Customer Service Center at 0800 442 584

### For Singapore Market



Scan QR Code to visit  
[www.whirlpool.com.sg/warranty-registration](http://www.whirlpool.com.sg/warranty-registration)  
to register your product warranty online.

This QR Code is only applicable to Singapore.  
You can download the user manual by

- Visiting our website [www.whirlpool.com.sg](http://www.whirlpool.com.sg)
- Contacting our Customer Service Center at +65 6250 6888 or email [helpdesk.sg@whirlpool.com](mailto:helpdesk.sg@whirlpool.com)