

HIZERO

Hard Floor Cleaner User Manual

F6 series

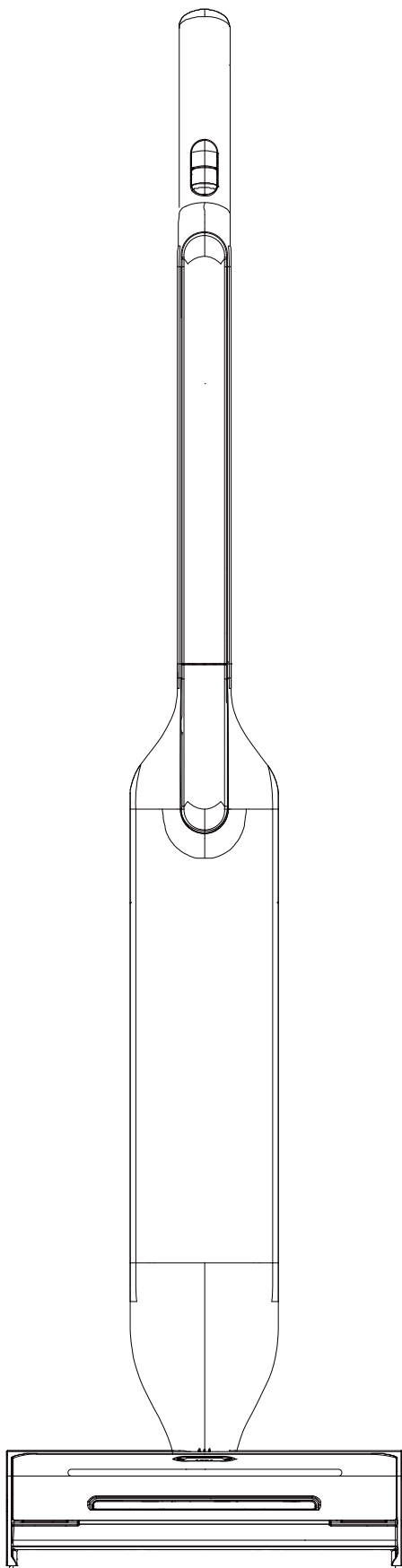

EN

IMPORTANT SAFETY INSTRUCTIONS

When using an electrical appliance, basic precautions should always be followed, including the following:

READ ALL INSTRUCTIONS BEFORE USING (THIS APPLIANCE)

WARNING-To reduce the risk of fire, electric shock, or injury:

- a) To Reduce the Risk of Fire due to internal component damage, use only HIZERO cleaning solution intended for use with the appliance. See the Best Results section of this manual. To Reduce the Risk of Fire, do not use a flammable or combustible liquid to clean a floor.
- b) For household use only. Do not use outdoors.
- c) Do not allow to be used as a toy. Close attention is necessary when used by or near children.
- d) Use only as described in this manual. Use only manufacturer's recommended accessories.
- e) Do not use with damaged cord or plug. If appliance is not working as it should, has been dropped, damaged, left outdoors, or dropped into water, return it to service center.
- f) Do not pull or carry by cord, use cord as a handle, close a door on cord, or pull cord around sharp edges or corners. Do not run appliance over cord. Keep cord away from heated surfaces.
- g) Do not unplug by pulling on cord. To unplug, grasp the plug, not the cord.
- h) Do not handle plug or appliance with wet hands.
- i) Do not put any object into openings. Do not use with any opening blocked; keep free of dust, lint, hair, and anything that may reduce air flow.
- j) Keep hair, loose clothing, fingers, and all parts of body away from openings and moving parts.
- k) Turn off all controls before unplugging.
- l) Use extra care when cleaning on stairs.
- m) Do not use to pick up flammable or combustible liquids, such as gasoline, or use in areas where they may be present.

WARNING:

Read all safety warnings and instructions. Failure to follow the warnings and instructions may result in electric shock, fire and/or serious injury.

- n) Prevent unintentional starting. Ensure the switch is in the off-position before picking up or carrying the appliance. Carrying the appliance with your finger on the switch or energizing appliance that have the switch on invites accidents.
- o) Turn off the appliance before making any adjustments, changing accessories, or storing appliance.
- p) Recharge only with the charger specified by the manufacturer. A charger that is suitable for one type of battery pack may create a risk of fire when used with another battery pack.
- q) Use appliances only with specifically designated battery packs. Use of any other battery packs may create a risk of injury and fire.
- r) Under abusive conditions, liquid may be ejected from the battery; avoid contact. If contact accidentally occurs, flush with water. If liquid contacts eyes, additionally seek medical help. Liquid ejected from the battery may cause irritation or burns.
- s) Do not use a battery pack or appliance that is damaged or modified. Damaged or modified batteries may exhibit unpredictable behavior resulting in fire, explosion or risk of injury.
- t) Do not expose a battery pack or appliance to fire or excessive temperature. Exposure to fire or temperature above 130°C may cause explosion. The temperature of 130°C may be replaced by the temperature of 265°F.
- u) Follow all charging instructions and do not charge the battery pack or appliance outside of the temperature range specified in the instructions. Charging improperly or at temperatures outside of the specified range may damage the battery and increase the risk of fire.
- v) Have servicing performed by a qualified repair person using only identical replacement parts. This will ensure that the safety of the product is maintained.
- w) Do not modify or attempt to repair the appliance or the battery pack (as applicable) except as indicated in the instructions for use and care.
- x) The plug must be removed from the socket-outlet before cleaning or maintaining the appliance
- y) This appliance is not intended for use by persons (including children) with reduced physical, sensory or mental capabilities, or lack of experience and knowledge, unless they have been given supervision or instruction concerning use of the appliance by a person responsible for their safety.
- z) Children should be supervised to ensure that they do not play with the appliance.

SAVE THESE INSTRUCTIONS

Thank you for choosing the HIZERO All in One Hard Floor Cleaner and congratulations for making the right choice to have crystal clean floors with less effort! Harnessing patented game-changing technology, your HIZERO integrates the functions of sweeping, mopping, and drying stone, wood, cork and laminate hard floors. Your cleaner has a built in rechargeable battery to give you all the freedom-of-movement benefits of wireless cleaning, while the self-cleaning multi roller automatically separates solid and liquid dirt and messes into separate compartments. You can now enjoy high cleaning efficiency, simple operation and easy maintenance. This user manual also provides you useful tips about how to get the most out of your Hizero floor cleaner for a cleaner, healthier and easier lifestyle, so we suggest you read it through carefully and keep handy for future reference.

1. Safety Instructions



1.1 Warning

For the purposes of recharging the battery, only use the detachable supply unit provided with this appliance.

Do not move Hizero over the following:

- Electrical cable
- Parts of the human body
- Large solid objects

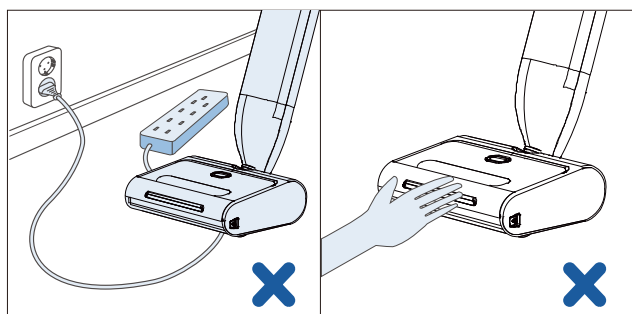

1.2 Caution

- Remove product from docking station, prior to operating or maintaining it.
- Always switch off prior, before removing water tanks or opening the cleaning head.
- To avoid damaging: do not use to clean up broken glass or sharp objects.
- Do not immerse or rinse the body under water. As this will cause irreparable damage. Do not immerse the cleaning head under water.
- Never use the product to clean flammable or combustible liquids and do not put flammable or combustible liquids in the clean/dirty water tank.
- Regularly maintain the product. If damaged take it to an authorized service center.
- This appliance can be used by children aged from 8 years and above and persons with reduced physical, sensory or mental capabilities or lack of experience and knowledge if they have been given supervision or instruction concerning use of the appliance in a safe way and understand the hazards involved.
- Children shall not play with the appliance
- Cleaning and user maintenance shall not be made by children without supervision.

- Never store the product at a temperature lower than 0°C/32°F.
- Only use clean water with or without Hizero cleaning solution, in the clean water tank.
- Do not put anything acidic (example vinegar), or not Hizero authorized detergents, in both the clean or dirty water tanks.
- Do not use wax, oil or floor maintenance products, in the clean water tank. Use HIZERO authorized battery pack only!
- Charge only with Hizero power adapters.
- Battery can only be used for Hizero hard floor cleaner, is not interchangeable with other products. Do not expose the battery to heat (50°C/122°F), water or the outdoors.
- In the event of battery leakage, cease use immediately and call a Hizero authorized service centre.
- Batteries should be replaced by skilled technicians.
- Discard non functioning batteries, as regulated by your country of origin.
- Use only HIZERO specified cleaning solution to prevent any damage to internal components.
- Do not clean the cleaning roller, with sharp objects. As this will damage it and reduce the cleaning performance.
- When there is water in either of the water tanks, never put the product on its side or upside down in order to prevent any leakages.
- Empty the waste water tank after use, to prevent bacteria and odor buildup. Not dishwasher safe.
- This product is intended for the indoor use only (not outdoor use).

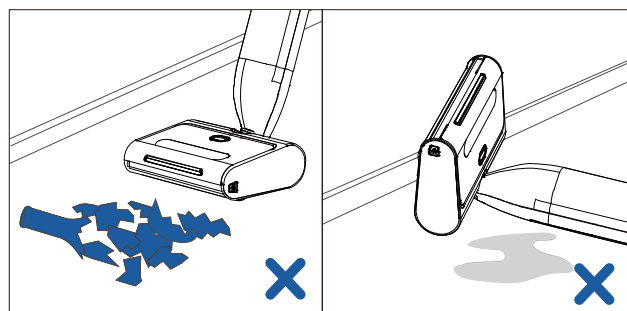

1.3 Compliance

This product complies with the current recognized electrical product technical specifications and safety regulations. It is safe to use the product if the user operates according to the instructions of this user manual.

1.4 Self-Protection System

This product will automatically stop, if a large object is caught in the cleaning roller.

1.5 Intended Use

This product is designed to be used on waterproof hard flooring. (e.g. Tiles/Wood/Concrete/Marble)
Not to be used on carpets or any water absorbent floor coverings.

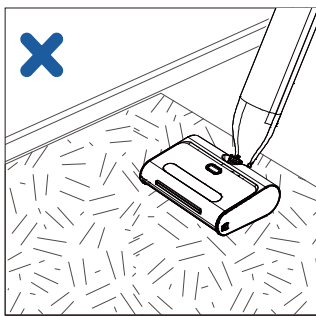

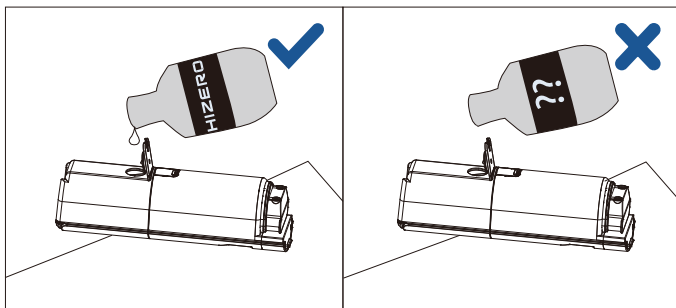

1.6 Best Results

Please use this use and care guide in conjunction with any manuals you may have for your floor to obtain the best result. HIZERO only recommends our cleaning solution to enhance your result.



 : detachable supply unit

 : read operator's manual

 : This marking indicates that this product should not be disposed with other household wastes throughout the EU. To prevent possible harm to the environment or human health from uncontrolled waste disposal, recycle it responsibly to promote the sustainable reuse of material resources. To return your used device, please use the return and collection systems or contact the retailer where the product was purchased. They can take this product for environmental safe recycling.

This device must accept any interference received, including interference that may cause undesired operation.

Please note that changes or modifications of this product is not expressly approved by the party responsible for compliance could void the user's authority to operate the equipment.

Note: This equipment has been tested and found to comply with the limits for a Class B digital device, pursuant to Part 15 of the FCC Rules. These limits are designed to provide reasonable protection against harmful interference in a residential installation. This equipment generates, uses and can radiate radio frequency energy and, if not installed and used in accordance with the instructions, may cause harmful interference to radio communications. However, there is no guarantee that interference will not occur in a particular installation.

If this equipment does cause harmful interference to radio or television reception, which can be determined by turning the equipment off and on, the user is encouraged to try to correct the interference by one or more of the following measures:

- Reorient or relocate the receiving antenna.
- Increase the separation between the equipment and receiver.
- Connect the equipment into an outlet on a circuit different from that to which the receiver is connected.
- Consult the dealer or an experienced radio/TV technician for help.

2. Components in the box

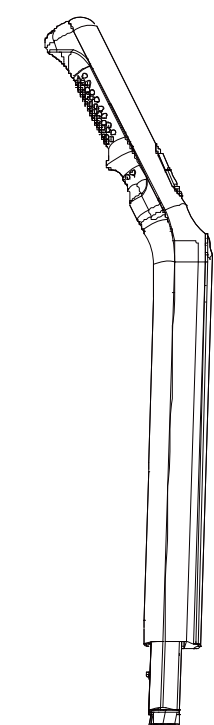

Upper Body x 1

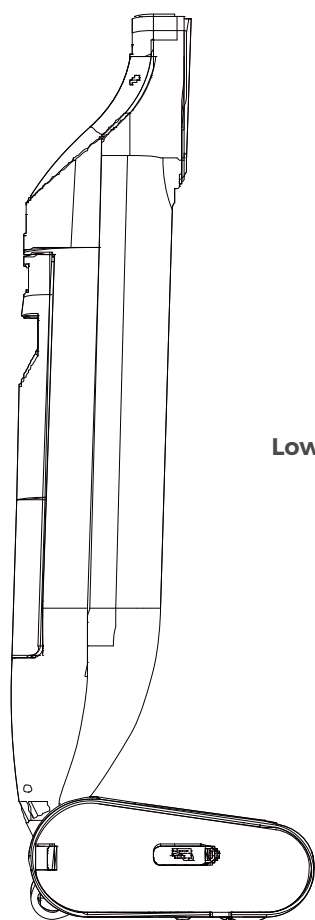

Lower Body x 1

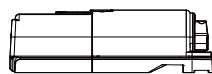

2-in-1 Water Tank x 1 (Installed)

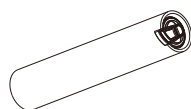

Multi Roller x 1

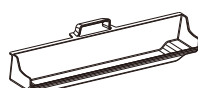

Solid Waste Container x 1 (Installed)



Hair Collection Roller x 1 (Installed)



Docking Station x 1

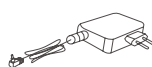

Power Adapter x 1



Cleaning Brush x 1



Dirty Water Tank Brush x 1



Brush Comb x 1



User Manual x 1





Hizero Cleaning Solution x 1 (Optional)









Wiper (One piece Pre-installed, with one spare)

3. Control Panel

3.1 Buttons

-  On/Off Button: Push to switch on and off the unit
-  Mode Button: Push to switch between Economy Cleaning Mode and Intensive Cleaning Mode

3.2 Display

-  **Economy Cleaning Mode:** Normal mode. A full tank of clean water can last for approximately 17 minutes.
-  **Intensive Cleaning Mode:** High water flow mode. A full tank of clean water can last for approximately 12 minutes.
-  **Clean Water Status:** When it blinks, fill the clean water tank.
-  **Dirty Water Status:** When it blinks, empty the waste water tank.
-  **Operation Status:** Check both rollers when it blinks.
-  **Battery Status:** The circle indicates the remaining battery. The indicator turns red: Low battery. The unit will power off when the battery runs out.

3. Unpack the multi roller. If the roller is dry and hard, please soak the roller with warm water not higher than 50°C (15°C-40°C is recommended). When soaking, you can also squeeze the entire body of the roller evenly until it becomes completely soft. Squeeze out the excess water until it does not drip.

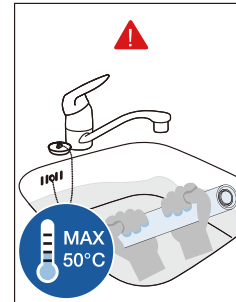

4. Remove the cleaning head lid, and install the multi roller onto the cleaning roller motor.

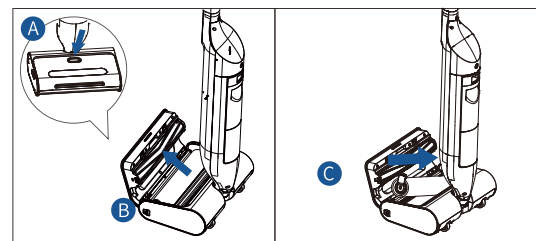

5. Push the multi roller back in and make sure that the snap-fit locks properly.

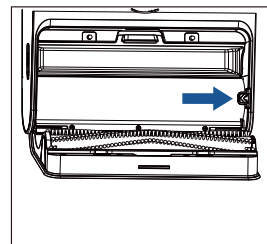

4. Preparing for use

4.1 Assembly

1. Push the lower body forward slightly and hear a "click" indicating that the lower body is locked in place.

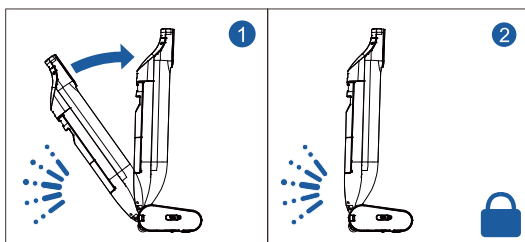

2. Insert the upper body into the lower body and hear a "click", ensure the upper body is connected firmly.

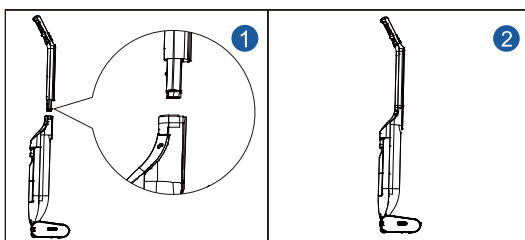

If needed, insert a tool tip into the snap hole in the back of the lower body to release the snap, and pull upwards to remove the upper body.

4.2 Charging

Plug the power adapter to the charging port of the product.

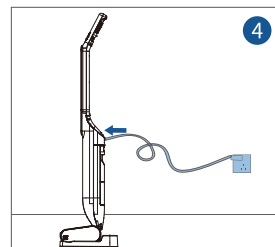

4.3 Remove Large Objects from the Floor

Before using the product, please remove large objects such as toys, power cords and shoes from the floor to be cleaned.

5. Operation

5.1 Fill the Clean Water Tank

Fill the clean water tank before use.

1. Unlock and take out the 2-in-1 water tank. To prevent the body from tipping over, hold the body upright with the other hand. Open the clean water tank cap and fill in clean water (max 40°C/104°F). If necessary, add HIZERO cleaning solution (See 1.6 Best Results).

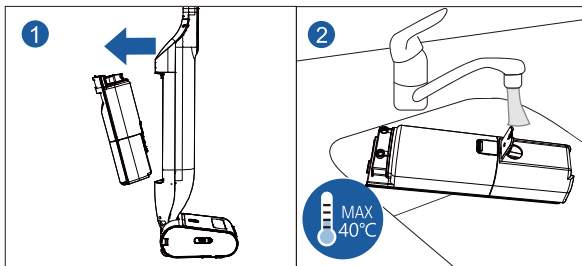

Note: Only use Hizeo Cleaning Solution. Refer to the instructions of the Hizeo Cleaning Solution. Add Hizeo Cleaning Solution before adding clean water.

2. Seal the clean water tank cap, and then put the clean water tank back into the body, making sure that the clean water tank is installed in place. To prevent the body from tipping over, hold the body upright with the other hand.

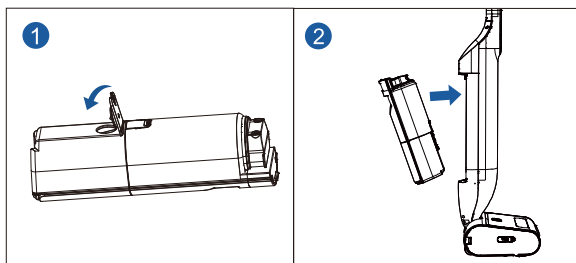

NOTE: To prevent the tank from falling out when cleaning the floor, make sure the tank is locked in with a clicking sound.

5.2 Unlock the body

Lift the product from the base and place it on a flat surface, place one foot on the cleaning head and then gently pull the body back to unlock the body. Press the On/Off button to turn on the product.

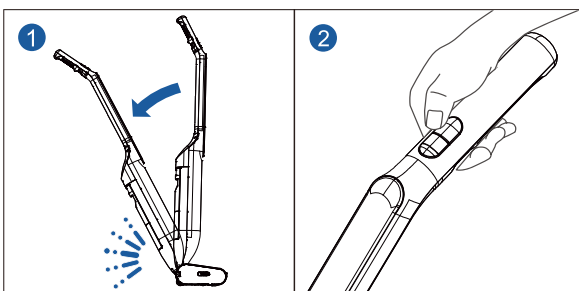

To lock the body, gently push the upper body forward until you hear a "click". Do not push it any further, or the product will be damaged.

Note: During locking or unlocking, the clicking sound is normal.

5.3 Floor Cleaning

1. For the best performance, it is recommended to remove any large solid wastes or spills first and clean the floor with forward and backward motions. It is recommended to start from the area furthest from the door to avoid stepping on cleaned floor.

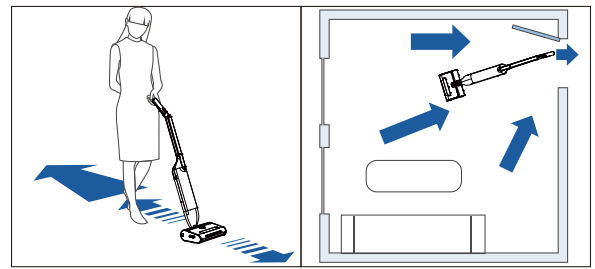

2. Clean heavy dirt, large solids, and spills with forward motion.



To clean stubborn stains, leave the unit running at the same spot for repeated cleaning.

3. Do not lay the product flat.

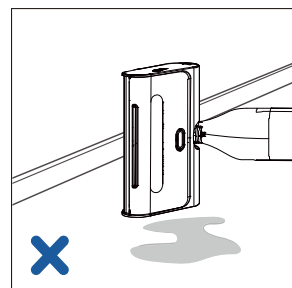

4. If the cleaning roller is jammed by a foreign object, press the power button to turn off the machine immediately. Open the cleaning head lid, remove the cleaning roller, and remove the foreign object.

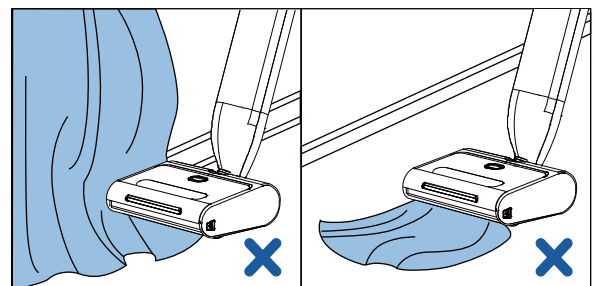

5.4 Water Status

When the water tanks need attention, the water status indicators will blink. When the clean or waste water tank indicator blinks, turn off the unit to refill the clean water tank and empty the waste water tank. When the clean water status indicator blinks, the unit will automatically stop running shortly.

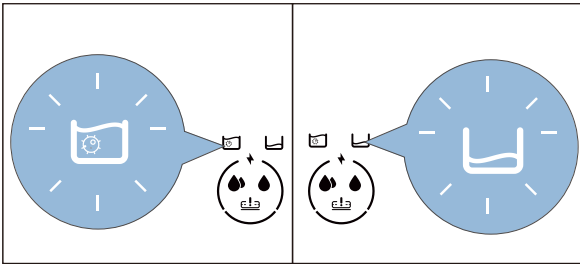

5.5 Empty the Dirty Water Tank

1. Lock the body and take out the 2-in-1 water tank. Open the waste water tank lid and empty the waste water tank slowly. Watch out for overflow/spillage.

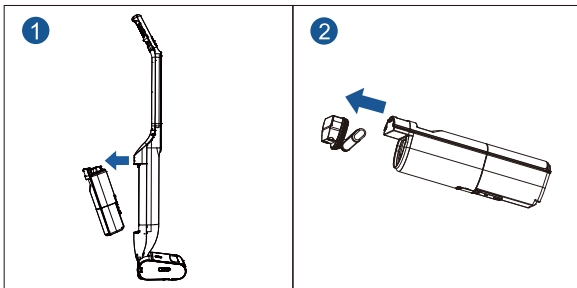

2. Rinse the waste water tank and the lid gently and use the dirty waste tank brush if necessary. Close the waste water tank lid and install the dirty water tank back into the cleaning head.

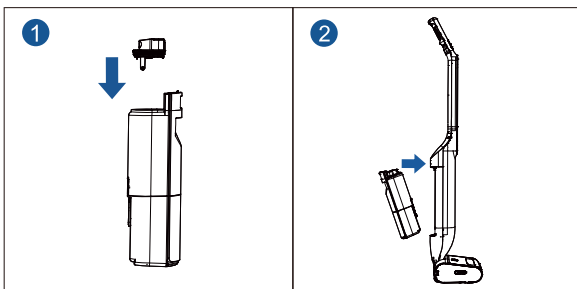

Note: 1. To avoid water leakage, make sure the waste water tank is installed properly.
2. Empty and rinse the waste water tank after each use to avoid odor build up.

5.6 Empty the Solid Waste Container

Open the cleaning head lid. Take out solid waste container and use the cleaning brush to sweep the trash into a dustbin.

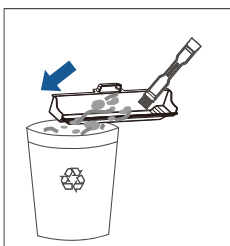

5.7 Automatic Protection System

The automatic protection system is used to identify abnormalities in the operation of the product. When this system is activated, the unit will stop operation immediately to prevent damage to objects and the product. To continue operation, please follow the instructions below!

1. Open the cleaning head lid and remove the jammed object.
2. If this does not resolve it, remove the multi roller and hair collection roller for further inspection.
3. After removing the obstruction, re-install the multi roller and hair collection roller.
4. Contact support center if the problem persists.

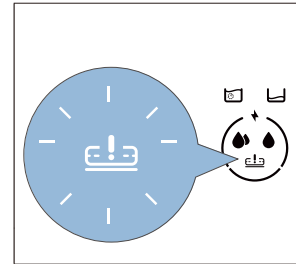

6. Maintenance & Cleaning



Note: The power adapter should be removed and the product should be switched off before cleaning or maintaining.

6.1 Maintenance

1. Regularly clean the exterior of the product with dampened soft cloth. Do not use caustic detergents or material like steel wool, as this will cause damage to the outer body.
2. To avoid any damage, do not immerse the product in water or any other liquid, or rinse any parts other than the cleaning head under the tap.
3. Regularly check the multi roller and hair collection roller.
4. Regularly check the power adapter to ensure the power cable is intact and safe to use.

6.2 Clean the Brush Roller

1. To remove and install the hair collection roller, refer to Chapter 8 Accessory Replacement.
2. Use the brush comb tool to clean from one end to the other.
3. Clean the hair collection roller (applying some cleaning solution is recommended).

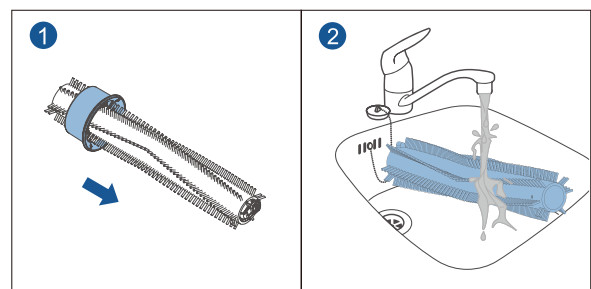

6.3 Clean the Multi Roller

Method 1: Automatic self-cleaning

1. Fill the clean water tank and empty the waste water tank (add some Hizeo cleaning solution to the fresh water tank) and re-install them. Lock the body, then put the product on the base dock properly, and unplug the power plug.
2. Press the power button to start the product, press the mode button to switch to mode 2. Keep the unit running until the self-cleaning is done.
3. The cleaning roller self-cleaning can be carried out on the base or suspended by hand (make sure unit is in upright position).
4. Repeat the self-cleaning for multiple times to achieve better cleaning effect if necessary.

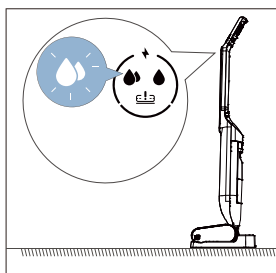

Method 2: Manual Cleaning

Please refer to Chapter 8 Accessory Replacement, remove the roller first and then clean the roller.

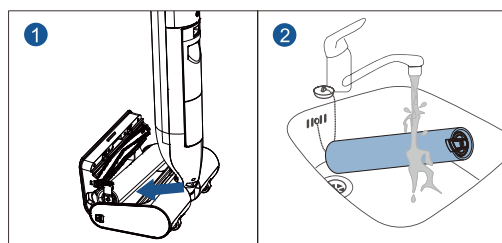

Squeeze out the excess water and reinstall the multi roller into the unit.

The cleaning roller can also be placed on the right stand on docking station for drying, to avoid odor and deformation.

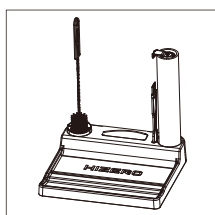

6.4 Clean the Grate Filter

1. When the filter is clogged, please clean the filter.
2. Find the rubber plug on the side of the cleaning head, and pull out the grate filter.
3. Clean and dry the grate filter, insert back the grate filter. Make sure the rubber plug is flush to the side of the cleaning head.

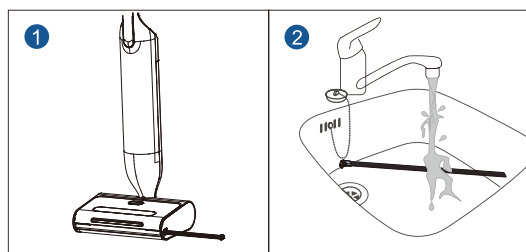

6.5 Clean the cleaning head lid

The cleaning head lid can be taken out for thorough cleaning.

1. Unlock the cleaning head lid and open it to about 90°, to unlock the cleaning head lid hinge.
2. Move the cleaning head lid horizontally to the front. If it cannot be taken out, adjust the angle slightly. Do not force the lid to avoid damages to the product.
3. Rinse the cleaning head lid with clean water. Do not soak it or apply corrosive solutions to it. Wipe it dry after cleaning.
4. Aim the cleaning head lid hinge to the support on the cleaning head, insert back the lid horizontally to assemble the lid back to the cleaning head lid.
5. Close the cleaning head lid, and lock it with a gentle press.

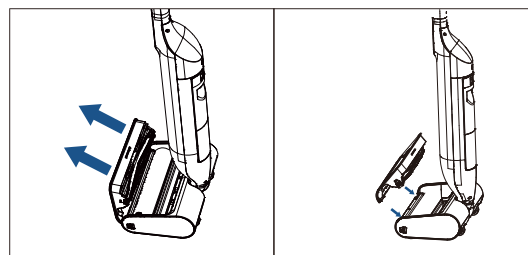

7. Storing & Moving

7.1 Storing

1. Before storing, switch off the product, lock the body and place it onto the docking station.
2. Clean the interior of the cleaning head before storage to prevent bacteria from breeding.
3. Before storage, please make sure to empty the clean/waste water tank.
4. If the product will not be used for more than a week, disconnect the power adapter, and take out the multi roller to dry it before storing the product.

7.2 Moving

1. Make sure the product is switched off and locked in upright position.
2. To move the product, tilt the product backwards to use the back wheels.

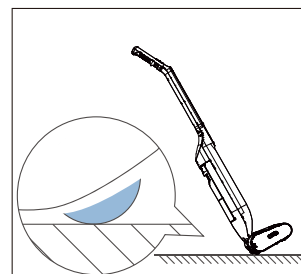

Note: If there is sand or other sharp objects on the floor, do not move the product with the wheels to avoid possible scratches.

8. Accessory Replacement

8.1 Replace the Multi Roller

For better experience and cleaning results, please ensure that you use the HIZERO multi roller. We also recommend that you monitor the condition of the cleaning roller and replace it if it is torn, broken, chipped, hardened to ensure cleaning results. We recommend that you replace it once every 6 months.

1. Please switch off and lock the product.
2. Open the cleaning head lid.
3. Follow the arrow and release the multi roller snap.
4. Remove the old multi roller, and insert the new one.
5. Push the multi roller back in and make sure that the snap-fit locks properly. Close the cleaning head lid.

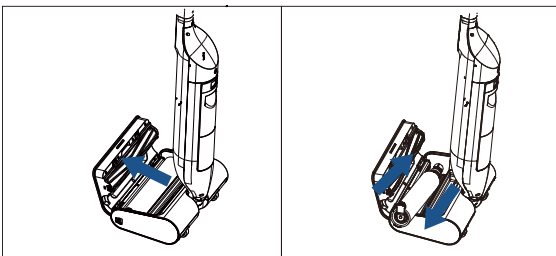

Note: The maximum opening angle of the cleaning roller motor is approximately 45°, so please operate with caution.

8.2 Replace the Hair Collection Roller

For better experience and cleaning results, please make sure to use HIZERO Hair Collection Roller. We also recommend that you pay attention to the condition of the Hair Collection Roller.

1. Please switch off and lock the product.
2. Remove the cleaning head lid.
3. Press and release the hair collection roller snap.
4. Remove the old hair collection roller and insert the new one.
5. Push the hair collection roller back in and make sure that the snap-fit locks properly. Close the cleaning head cover.

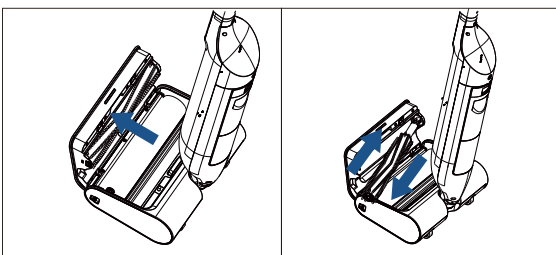

8.3 Replace the Wiper

For better experience and cleaning effect, please make sure to use HIZERO wiper. We also recommend that you pay attention to the condition of the wiper and replace it if it is torn, broken, chipped, hardened or deformed to ensure the cleaning effect.

1. Please turn off and lock the product.
2. Remove the cleaning head lid, and remove the cleaning roller.
(Refer to 8.1 Replace the Cleaning Roller)
3. Open the wiper snap, and slide out the old wiper.
4. Slide in the new wiper and close the wiper snap.
5. Install back the cleaning roller and the cleaning head lid. (Refer to 8.1 Replace the Cleaning Roller)

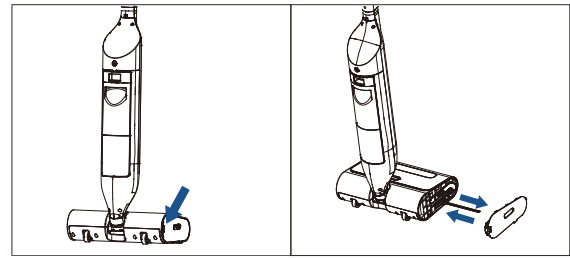

Note: Old multi rollers, hair collection roller, and wipers are all plastic waste, so please dispose of them properly and recycle them according to local environmental laws and regulations.

9. Caring for the Environment

Please do not dispose of this product as common household garbage. It is highly recommended to take the product to the local recycle station as an effort to protect the environment.

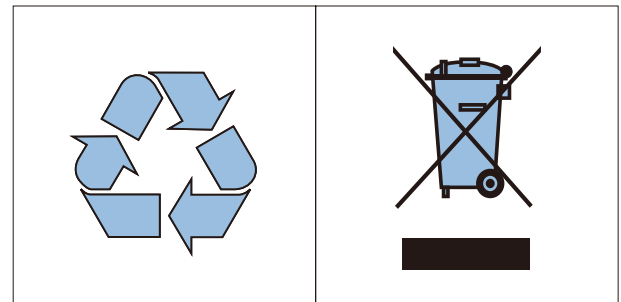

10. Specifications

Power Adapter Input	100–240V ~ 50/60Hz
Power Adapter Output	21V === 1.0 A
Power	Refer to nameplate
Operating Voltage	Refer to nameplate
Net Weight	4.5 kg
Dimensions	1163 × 224 × 295 mm

11. Warranty & After-sales

For the detailed information of warranty and after-sales service, please visit our website: www.hizero.com or contact HIZERO Customer Service Centre in your country/region.

Your Hard Floor Cleaner has been designed and developed with the greatest possible care. In the unfortunate case that the product needs repair, the Customer Service Centre in your country/region will help you by arranging any necessary repairs in the shortest possible time with maximum convenience.



Hizero Appliances Corporation will not be liable for any damage resulting from improper use or disassembly by customers.

HIZERO