

RCA

U
S
E
R
M
A
N
U
A
L

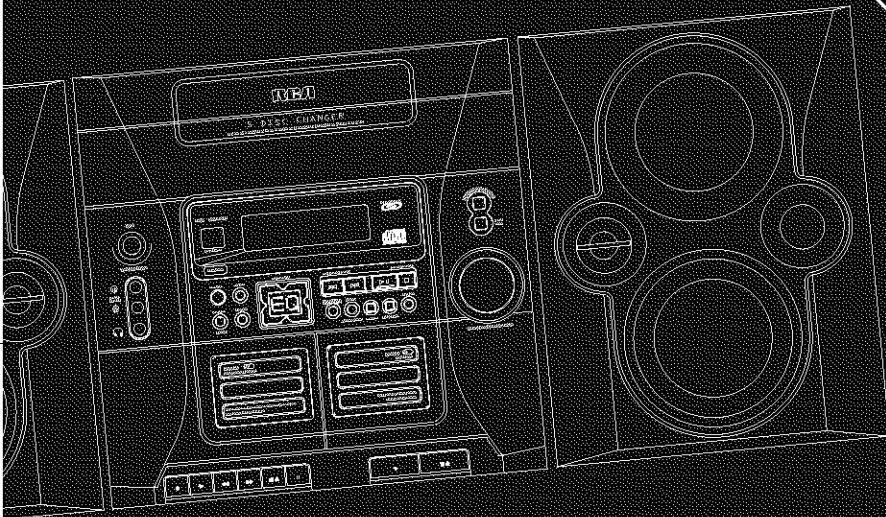

RS2622

It is important to read this instruction book prior to using your new product for the first time.
Es importante leer este manual antes de usar por vez primera su equipo.

FCC Information

This device complies with Part 15 of the FCC Rules. Operation is subject to the following two conditions: (1) This device may not cause harmful interference, and (2) this device must accept any interference received, including interference that may cause undesired operation.

In accordance with FCC requirements, changes or modifications not expressly approved by Thomson multimedia Inc. could void the user's authority to operate this product.

This device generates and uses radio frequency (RF) energy, and if not installed and used properly, this equipment may cause interference to radio and television reception.

If this equipment does cause interference to radio or television reception (which you can determine by unplugging the unit), try to correct the interference by one or more of the following measures:

- Re-orient the receiving antenna (that is, the antenna for the radio or television that is "receiving" the interference).
- Move the unit away from the equipment that is receiving interference.
- Plug the unit into a different wall outlet so that the unit and the equipment receiving interference are on different branch circuits.

If these measures do not eliminate the interference, please consult your dealer or an experienced radio/television technician for additional suggestions. Also, the Federal

Communications Commission has prepared a helpful booklet, "How To Identify and Resolve Radio TV Interference Problems." This booklet is available from the U.S. Government Printing Office, Washington, DC 20402. Please specify stock number 004-000-00345-4 when ordering copies.

This product complies with DHHS Rules 21 CFR Subchapter J. Applicable at the date of manufacture.

For Your Safety

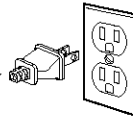

The AC power plug is polarized (one blade is wider than the other) and only fits into AC power outlets one way. If the plug won't go into the outlet completely, turn the plug over and try to insert it the other way. If it still won't fit, contact a qualified electrician to change the outlet, or use a different one. Do not attempt to bypass this safety feature.



CAUTION: TO PREVENT ELECTRIC SHOCK, MATCH WIDE BLADE OF PLUG TO WIDE SLOT, FULLY INSERT.

Have a Blast- Just Not in Your Eardrums
Make sure you turn down the volume on the unit before you put on headphones. Increase the volume to the desired level only after headphones are in place.



	<p>CAUTION RISK OF ELECTRIC SHOCK DO NOT OPEN</p>	
<p>THE LIGHTNING FLASH AND ARROW-HEAD WITHIN THE TRIANGLE IS A WARNING SIGN ALERTING YOU OF "DANGEROUS VOLTAGE" INSIDE THE PRODUCT.</p>	<p>CAUTION: TO REDUCE THE RISK OF ELECTRIC SHOCK, DO NOT REMOVE COVER (OR BACK). NO USER-SERVICEABLE PARTS INSIDE. REFER SERVICING TO QUALIFIED SERVICE PERSONNEL.</p>	<p>THE EXCLAMATION POINT WITHIN THE TRIANGLE IS A WARNING SIGN ALERTING YOU OF IMPORTANT INSTRUCTIONS ACCOMPANYING THE PRODUCT.</p>
<p>SEE MARKING ON BOTTOM / BACK OF PRODUCT</p>		

WARNING: TO PREVENT FIRE OR ELECTRICAL SHOCK HAZARD, DO NOT EXPOSE THIS PRODUCT TO RAIN OR MOISTURE.

FCC Information

For Your Records

In the event that service should be required, you may need both the model number and the serial number. In the space below, record the date and place of purchase, and the serial number:

Model No.
Remote Control No.
Date of Purchase
Place of Purchase
Serial No.

Service Information

This product should be serviced only by those specially trained

in appropriate servicing techniques. For instructions on how to obtain service, refer to the warranty included in this Guide.

Technical specification

Power Supply: 120V-60Hz
Power consumption: 135 Watts

IMPORTER
Comercializadora Thomson de México, S.A. de C.V.
Miguel de Cervantes Saavedra 57
Col. Ampliación Granada
C.P. 11529 Mexico D.F.
Telefono: (55)25 81 53 20
RFC: CTM-980723-KS5

EN

CONTENTS

FCC Information

Getting started 3

General controls

Main Unit 4
Tape Player 4
Remote Control 5

Display settings

Showing the Demonstration
..... 6
Display Timer/Clock 6
Setting the Time 6
Setting the Timer 6
Activating the Timer 6
Adjusting the Display
Brightness 6
Sleep Mode 6

Sound Features

Using Preset Equalizer Curves
..... 7
Creating a Custom Curve .. 7

B Boost 7
Muting Audio 7

CD Player

Loading Discs 7
Playing Discs 7
Shuffling the Play Order ... 7
Sampling Tracks 7
Repeating the Play Order .. 8
CD display 8
Setting Up a CD program .. 8
Playing a Program List 8
Displaying the Program list
..... 8
Deleting a Program List ... 8
Skipping a Disc 8
Searching through a CD ... 8

Radio

Tuning to a Station 9
Using Presets 9
Auto Preset Program (for FM
only) 9
Setting Presets 9
Suppressing Stereo Signal .. 9

Tape Player

Playing a Tape 10
Continuous Play 10
Recording 10
From Tuner 10
From CD 10
Tape to Tape 10
From an Auxiliary Input .. 10

Troubleshooting Tips

..... 11

Important Information 12

Limited Warranty

Getting Started

EN

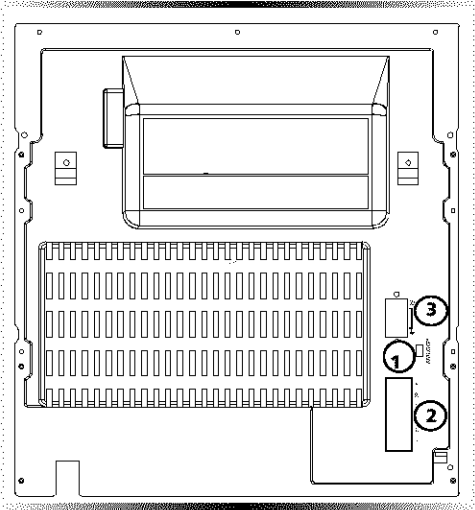

1. AM Loop Antenna Connector
2. Main Speaker Jacks
3. FM Antenna Jacks

Unpacking the system:

You should have:

- one main unit (with 2 speakers);
- one remote control;
- one AM loop antenna;
- T-Type FM antenna wire;
- one user's guide;
- one safety leaflet.
- owner registration card

To ensure sufficient ventilation, keep the spacings shown below free from other surfaces:

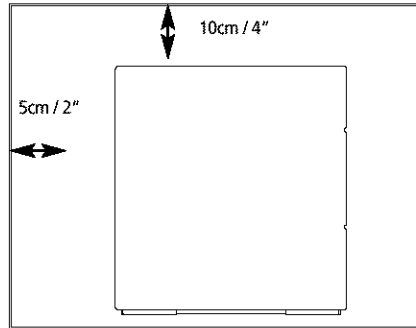
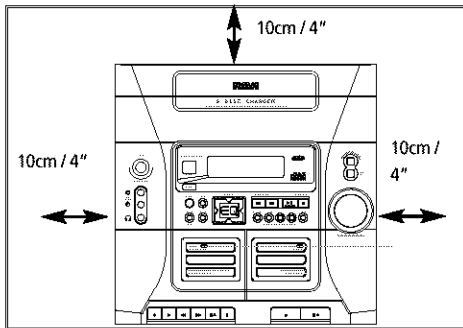

Antenna and Speaker Wire Connection

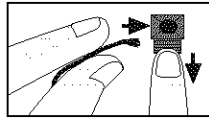

Push terminal tab down to insert wire.

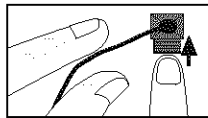

Release tab to lock wire in the terminal.

NOTE: Make sure the insulation is completely removed from the ends of the Antenna and speaker wires at all connection points.

General Controls

EN

Remote Control

- ON** — Turns power on or off (**STANDBY** mode).
- TUNER** — Selects tuner
- CD** — Selects CD player
- TAPE** — Selects tape player
- AUX** — Selects external input.
- B-BOOST** — Turns BASS BOOST on or off
- VOL+ or VOL-** — Increases/ decreases volume
- EQ** — Selects equalizer presets
- PLAY/PAUSE**  — Plays or pauses current CD
- STOP** — Stops playing CD
- NEXT/FWD**  — Increments CD track; searches through CD
- PREV/REV**  — Decrements CD track; searches through CD (Press **NEXT/FWD** or **PREV/REV** to tune up/ down tuner frequency)
- DISC SKIP** — Skips to next CD
- REPEAT** — Repeats a track, CD, or all CDs
- MUTE** — mutes sound
- SHUFFLE** — Turns on/off random listening
- FM ST.** — Toggles between FM stereo and mono
- INTRO** — Turns **INTRO** mode on or off to play the first 10 seconds of each track.
- PRESET UP/DOWN** — Selects next/ previous preset station
- OPEN/CLOSE** — opens/closes cd tray door
- SLEEP** — selects the time interval in minutes before the unit turns off
- X-SURROUND** — enables/disables X-surround feature

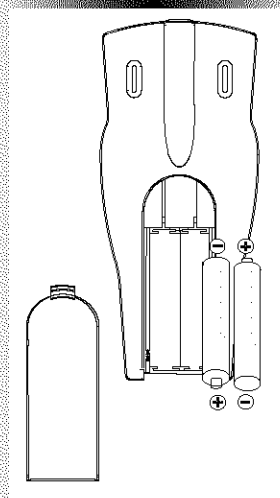
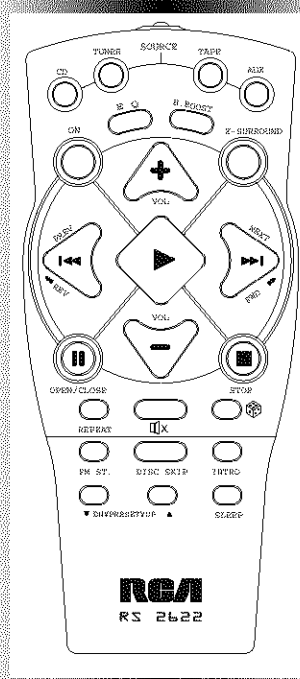

Battery Size:
"AAA" or "UM-4" or "R03"

Display Settings

EN



Showing the Demonstration

In all mode, press **DIMMER/DEMO** to turn on/off magic demonstration except timer on or sleep mode is active.

DISPLAY TIMER/CLOCK

Setting the Time

1. Press and hold **CLOCK** until the hour flashes on the display.
2. Press **SKIP BACKWARD** or **SKIP FORWARD** to set the hour and then press **CLOCK** to shift to minute digits.
3. Press **SKIP BACKWARD** or **SKIP FORWARD** to set the minute.
4. Press **SET** to save settings and **STOP** to quit setting.

Note: When system is ON, you can press **CLOCK** to display the current time for about 2 seconds.

Setting the Timer

1. Press and hold **TIMER** until the **ON** appear with the hour flashing (**ON** - timer on time)
2. For setting time, press **SKIP FORWARD** / **BACKWARD** to set the hour and then press **TIMER** to shift to minute digits.
3. Press **SKIP FORWARD** / **BACKWARD** to set the minute.
4. Press **TIMER** to change to **OF** (timer off time) with hour flashing. Repeat steps 2 & 3 for timer off time setting.
5. Press **TIMER** to select source. Press **SKIP FORWARD** / **BACKWARD** to select between CD /TUNER / TAPE)
6. Press **TIMER** to set volume. Rotate the VOLUME knob to set desired volume level.
7. Press **SET** to save settings or **STOP** to quit setting.

Activating the Timer

Press and release **TIMER** to turn on/off the alarm. The alarm is active when the clock icon indicator is lit.



Adjusting the Display Brightness

1. Press and hold **DIMMER/DEMO** for more than 2 seconds.
2. While the dimmer is displayed, press and release **DIMMER/DEMO** to select the desired level (**DIMM 1 - 3**).

DIMM 2

Note: You can only adjust the dimmer level when unit is in ON mode, in standby mode the dimmer level remains at DIMM 3, while in magic demo mode the dimmer level will be at DIMM 1.

Sleep Mode

You can select the time interval in minutes before the unit turns off automatically. Press **SLEEP** on the remote to select among 120, 90, 60, 45, 30, 15 & 5 minutes. (Remote Only)

Sound Features

EN

Using Preset Equalizer Curves

Press **EQ** on the main unit or on the remote to toggle among **FLAT**, **ROCK**, **POP**, **JAZZ**, **CLASSIC** & **CUSTOM**. The display shows briefly the selection.

Creating a Custom Curve

1. Press **EQ** repeatedly to select **CUSTOM** mode.
2. While "**CUSTOM**" is displayed, press **SKIP FORWARD** **▶▶▶▶** / **BACKWARD** **◀◀◀◀** to cycle among displayed bass- and treble - range levels.

3. While **BAS**, or **TRE** is displayed, adjust **VOLUME** to set the associated gain between -10 - +10.

TRE +08

Bass Boost

Press **B.BOOST** to turn on/off boosting the bass frequency.

Muting Audio

Press **MUTE** on the remote to cut the sound. (Remote Only)

MUTE

X-Surround

Press **X-SURROUND** to enjoy enriched sound quality. This feature gives you:

1. Better width and depth for vocal and instrumental sound.
2. More powerful presence for studio recording.
3. Enhanced surround effects with greater flexibility in positioning speakers.

CD Player

Loading Discs

1. Press **SOURCE** repeatedly to select **CD** mode.
2. Press **OPEN/CLOSE** to open the drawer.
3. Insert up to five discs with label face up. (Press **DISC SKIP** to rotate the disc carrier.)
4. Press **OPEN/CLOSE** to close the drawer. Loaded disc position icon lights.

Playing Discs

Press **PLAY/PAUSE** **▶||** to begin or pause playing, and **STOP** **■** to stop playing.

Select a specific disc by pressing **DISCSKIP**.

Press **SKIP FORWARD** **▶▶▶▶** / **BACKWARD** **◀◀◀◀** to select a specific track.

Play and load simultaneously by:

1. Press **OPEN/CLOSE** to open the tray while a CD is playing
2. Load/change discs for available trays by pressing **DISC SKIP**.
3. Press **OPEN/CLOSE** to close the tray.

Shuffling the Play Order

Press **SHUFFLE** to turn on/off the playing of tracks in random order. (Remote Only)

Sampling Tracks

Press **INTRO** to play the first 10 seconds of each track on the current disc, all discs in the tray, or turn **INTRO** mode off. (Remote Only)

(Note: You may also press **REPEAT** to select 1 disc or all discs before activating **INTRO** & **SHUFFLE** functions).

Repeating the Play Order

Press **REPEAT** to repeat the current track, current disc, all discs, or turn **REPEAT** mode off.

Setting Up a CD Program

You can program the CD player to play up to any 32 tracks on the CDs in the tray.

1. While the CD player is stopped, press **PROG/SET** to enter program mode. The system displays the next available program number: "-- P:01," with "--" flashing, prompts you for the first track in the program list.

2. Press **SKIP FORWARD**  / **BACKWARD**

 to select a track (press **DISC SKIP** to select a track from a different disc).



3. Immediately press **PROG/SET** to assign the selected track to the program number. After 3 seconds, you are prompted for the next track in the program list. (In CD program mode, **PROG** icon will be lit.)

Playing a Program List

While in **PROGRAM** mode, press **PLAY/PAUSE**  .

Displaying the Program List

1. While the CD player is stopped, press **PROG/SET** to enter program mode.
2. Press **PROG/SET** repeatedly to list each track assignment in the program list.

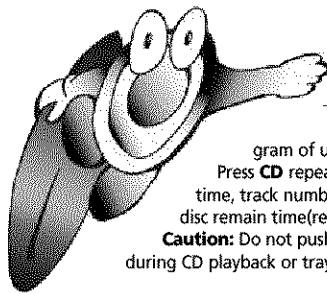

Tips: You can create a program of up to 32 tracks.

Press **CD** repeatedly to view elapsed track time, track number, track remain time and disc remain time(remote only).

Caution: Do not push to force closing of the tray during CD playback or tray opening.



Deleting Program List

While in **PROGRAM** mode, press and hold **STOP**  for 5 seconds. The system displays the message **CLEAR**.

Skipping a Disc

Press **DISC SKIP**.

Searching Through a CD

Press and hold **SKIP FORWARD**  / **BACKWARD**  to search through a CD as it is playing.

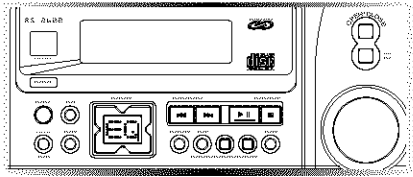

1. Press **SOURCE** to select **TUNER**.
2. Press **BAND** to select between AM or FM radio band.

Tip: Your audio system has 32 preset stations.





Tuning to a Station

Press **SKIP FORWARD**   / **BACKWARD**   to select frequencies.

Using Presets

The tuner can be in either TUNE or PRESET mode.









When in PRESET mode, the PROG light is on.

Press **SKIP BACKWARD**   or **SKIP FORWARD**   on the main system or **PRESET UP** or **DOWN** on the remote control to access the previous or next preset station. The display first shows the preset program number and after a few seconds, the frequency and preset program number will be displayed. (FM/PR:01 is FM preset 1)

Auto Preset Programming (for FM only)

Press and hold **BAND** button for 2 seconds to scan stations in FM band. The stations will then be stored as preset channels. A maximum 32 stations can be stored. Beware of your preset channels being erased accidentally because the scanning and storing process is automatic upon pressing the button. You can stop the automatic scan by pressing any button, but the erased stations cannot be recovered.

Setting Presets

1. Press **TUNE/PRESET** button to enter **TUNER** mode.
2. Press **SKIP FORWARD**   / **BACKWARD**   to access the desired frequency.
3. Press the **PROG/SET** button once.
4. The most recently accessed program location will be displayed.
5. If a different program location is preferred, press **SKIP BACKWARD**   / **FORWARD**   to move to the desired preset number (1-32).
6. Press **PROG/SET** to store the selected frequency at that preset.

Suppressing Stereo Signal

Press **FM ST** to toggle between FM mono and stereo for stereo FM stations. (Remote Only)



Tape player

EN

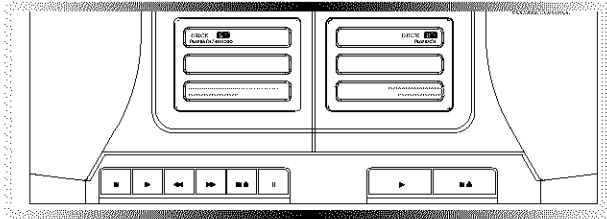

Playing a Tape

Tip: You can play a tape from either deck.

1. Press **SOURCE** repeatedly to select **TAPE**.
2. Open the cassette door.
3. Insert a tape into the door and push the door closed.
4. Press **REW** ◀◀/FWD ▶▶ to position the tape to the desired starting position. (Deck 1 Only)
5. Press **PLAY** ▶ to start playback .

Continuous Play

1. Insert a tape into deck 2 and start playback.
2. Insert a tape into deck 1 and press **PLAY** ▶ and **PAUSE** || together.
3. When the tape in deck 2 finishes playback, PAUSE at deck 1 will be released automatically and start playback.

Recording From Tuner

1. Insert a tape into deck 1.
2. Press **SOURCE** repeatedly to select **TUNER** and press **BAND** to access the desired radio band.
3. Tune to the station to be recorded.
4. Press **RECORD** ● to begin recording.
5. Press **STOP/EJECT** ■▲ to end recording.

From CD

1. Insert a tape into deck 1.
2. Press **SOURCE** repeatedly to select CD.
3. Insert the disc(s) to be recorded.
4. Select the track, CD, or program to be recorded.
5. Press **RECORD** ● to begin recording.
6. CD begins to play.
7. Press **STOP/EJECT** ■▲ to end recording.

Tape to Tape

1. Insert the destination tape in deck 1.
2. Insert the source tape into deck 2.
3. Press **PAUSE** || and then **RECORD** ● on deck 1.
4. Press **PLAY** ▶ on deck 2. The playback and recording start simultaneously.

From an Auxiliary Input

1. Insert the cassette in deck 1.
2. Check that the auxiliary device has been connected correctly to the AUX connector.
3. Start playback on the auxiliary device.
4. Press **RECORD** ● on deck 1 to begin recording.
5. Press **STOP/EJECT** ■▲ to end recording.

Troubleshooting Tips

EN

Problem	Solution	Problem	Solution
<i>System will not turn on</i>	<ul style="list-style-type: none"> • Check power cord for a secure connection. • Unplug the unit for a moment, and then plug into power source again. • Check the outlet by plugging in another device. 	<i>CD button will not respond, or does not change discs when you press DISC SKIP</i>	<ul style="list-style-type: none"> • Switch to another function (TAPE, Tuner) and then back to CD.
<i>No sound</i>	<ul style="list-style-type: none"> • Increase the volume setting. • Check connection to speakers. • Check that you have selected the appropriate function: CD, TAPE, Tuner. • Make sure mute is off. 	<i>Distorted or noisy tape recordings</i>	<ul style="list-style-type: none"> • Inspect the tape heads, clean it if necessary.
<i>Poor radio reception</i>	<ul style="list-style-type: none"> • Check antenna connection. • Move antenna. • Turn off nearby electrical appliances, such as hair dryer, vacuum cleaner, microwave, fluorescent lights. 	<i>Remote control does not work</i>	<ul style="list-style-type: none"> • Check that the batteries are properly installed. • Replace weak batteries. • Check the system is plugged into power source. • Point the remote directly at the system's front panel. • Move closer to the system. • Remove any obstacles between the remote and the system.
<i>CD does not play</i>	<ul style="list-style-type: none"> • Check that CD is in the tray. • Check that CD label is facing up. • Check that PAUSE mode is not on. • Check that CD function is selected. • Use CD lens cleaner. • Clean the disc. 		
<i>CD sound skips</i>	<ul style="list-style-type: none"> • Clean the disc. • Check disc for warping, scratches, or other damage. • Check if something is causing the system to vibrate. If so, move the system. • Make sure the speakers are at least 3 feet away or on a different surface from the main unit. 		

Important Information

EN

Disconnect the audio system from the power source before performing any maintenance.

Cleaning

Clean the exterior of the system using a soft dust cloth.

CD Player

CAUTION! This system operates with a laser. It must be opened by only a qualified technician.

Tape Player

To prevent deterioration of sound quality, periodically open the door of each deck and clean the magnetic heads, pinch roller, and capstan with a cotton bud dipped in alcohol. Also, demagnetize the head by playing a demagnetizing cassette (available through an audio equipment store).

To protect recordings one or both sides of a tape, remove the corresponding tab. If you later want to record on the tape, affix a piece of adhesive tape over the hole.

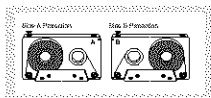

Quit Slacking - A little bit of slack in your tapes can cause scratches on the tape, or worse yet, the tape could break. If you notice some slack in the tape, use a pencil to tighten it up before you insert it.

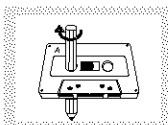

Safety Precautions

- Never open the cabinet under any circumstances. Any repairs or internal adjustments should be made only by a trained technician.
- Never operate this product with the cabinet removed.
- Do not use your System immediately after transporting it from a cold place to a warm place, as condensation may cause the system to malfunction.
- Keep your unit away from humid areas and abnormally hot places.
- Do not touch the player with wet hands. If any liquid enters the player cabinet, take the player to a trained technician for inspection.
- This compact disc player uses a laser to read the music on the disc. The laser mechanism corresponds to the cartridge and stylus of a record player. Although this product incorporates a laser pick-up lens, it is completely safe when operated according to directions.
- Discs rotate at high speed inside the player. Do not use damaged, warped, or cracked discs.
- Do not touch the pick-up lens which is located inside the disc compartment. To keep dust from collecting on the pick-up lens, do not leave the compartment door open for an extended period of time. If the lens becomes dirty, clean it with a soft brush, or use an air blower brush designed for camera lenses.
- The apparatus shall not be exposed to dripping and splashing.

Important Battery Information

- Remove the batteries to avoid leakage if you do not use your remote control for more than one month.
- Discard leaky batteries immediately as leaking batteries may cause skin burns or other personal injuries. Dispose of batteries in the proper manner, according to provincial and local regulations.
- Any battery may leak electrolyte under the following circumstances:
 - if mixed with a different battery type,
 - if inserted incorrectly,
 - if all batteries are not replaced at the same time,
 - if disposed of in fire, or
 - if an attempt is made to charge a battery not intended to be recharged.

Important Information

EN Headset Safety

- Do not play your headset at high volume. Hearing experts warn against extended high-volume play.
- If you experience ringing in your ears, reduce volume or discontinue use.
- You should use with extreme caution or temporarily discontinue use in potentially hazardous situations.

Even if your headset is an open-air designed to let you to hear outside sounds, do not turn up the volume so high that you are unable to hear what is around you.

Handling CDs

- Do not touch the signal surfaces. Hold CDs by the edges, or by one edge and the hole. Do not affix labels or adhesive tapes to the label surfaces. Do not scratch or damage the label. CDs rotate at high speeds inside the player. Do not use damaged (cracked or warped) CDs

Cleaning CDs

- Dirty CDs can cause poor sound quality. Always keep CDs clean by wiping them gently with a soft cloth from the inner edge toward the outer perimeter.
- If a CD becomes dirty, wet a soft cloth in water, wring it out well, wipe the dirt away gently, and then remove any water drops with a dry cloth.
- Do not use record cleaning sprays or antistatic agents on CDs. Also, never clean CDs with benzene, thinner, or other volatile solvents which may cause damage to disc surface

CD Lens Care

When your CD lens gets dirty it can also cause the system to output poor sound quality. To clean the lens you will need to purchase a CD lens cleaner which can maintain the output sound quality of your system. For instructions on cleaning the CD lens, refer to the ones accompanying the lens cleaner.

Don't Infringe

This product should only be used for the purposes for which it is sold, that is, entertainment, violating no copyright law. Any attempts to use this product for which it is not intended is unlawful and therefore not condoned by Thomson multimedia.

Technical Specification

Power supply: 120V~60Hz

Dimensions (H x W x D inches):

Unit size - 12.2 x 12 x 15.4 inches

Speaker - 12.2 x 9.4 x 7.7 inches

Tape deck: Response curve: 125Hz-8kHz (-5dB)

CD player: Response curve (+/- 2dB): 60Hz to 20 kHz

Rating Plate: Look for it at the back of the set.

Limited Warranty (U.S.)

EN

What your warranty covers:

- Defects in materials or workmanship.

For how long after your purchase:

- One year from date of purchase for labor and parts
- Warranty period for rental units begins with the first rental or 45 days from date of shipment to the rental firm, whichever comes first.

What we will do:

- Pay any Authorized RCA Audio Service Center the labor charges to repair your unit.
- Pay any Authorized RCA Audio Service Center for the new or, at our option, refurbished replacement parts required to repair your unit.

How you get service:

- Take your unit to any Authorized RCA Audio Service Center. To identify your nearest Authorized RCA Audio Service Center, ask your dealer, look in the Yellow Pages, or call 1-800-336-1900.
- Show the Authorized Service Center Representative your evidence of purchase date or first rental.
- Pick up your unit when repairs are completed.
- Proof of purchase in the form of a bill of sale or receipted invoice which is evidence that the product is within the warranty period must be presented to obtain warranty service. For rental firms, proof of first rental is also required.

What your warranty *does not* cover:

- Customer instruction. (Your Owner's Manual describes how to install, adjust, and operate your unit. Any additional information should be obtained from your dealer.)
- Installation and related adjustments.
- Signal reception problems not caused by your unit.
- Damage from misuse or neglect.
- Cleaning of audio heads.
- Batteries.
- A unit that has been modified or incorporated into other products or is used for institutional or other commercial purposes.
- A unit purchased or serviced outside the U.S.A.
- Acts of nature, such as but not limited to lightning damage.

Limited Warranty (U.S.)

EN Limitation of Warranty:

- THE WARRANTY STATED ABOVE IS THE ONLY WARRANTY APPLICABLE TO THIS PRODUCT. ALL OTHER WARRANTIES, EXPRESS OR IMPLIED (INCLUDING ALL IMPLIED WARRANTIES OF MERCHANTABILITY OR FITNESS FOR A PARTICULAR PURPOSE) ARE HEREBY DISCLAIMED. NO VERBAL OR WRITTEN INFORMATION GIVEN BY THOMSON MULTIMEDIA INC., ITS AGENTS OR EMPLOYEES SHALL CREATE A WARRANTY OR IN ANY WAY INCREASE THE SCOPE OF THIS WARRANTY.
- REPAIR OR REPLACEMENT AS PROVIDED UNDER THIS WARRANTY IS THE EXCLUSIVE REMEDY OF THE CONSUMER. THOMSON MULTIMEDIA INC. SHALL NOT BE LIABLE FOR INCIDENTAL OR CONSEQUENTIAL DAMAGES RESULTING FROM THE USE OF THIS PRODUCT OR ARISING OUT OF ANY BREACH OF ANY EXPRESS OR IMPLIED WARRANTY ON THIS PRODUCT. THIS DISCLAIMER OF WARRANTIES AND LIMITED WARRANTY ARE GOVERNED BY THE LAWS OF THE STATE OF INDIANA. EXCEPT TO THE EXTENT PROHIBITED BY APPLICABLE LAW, ANY IMPLIED WARRANTY OF MERCHANTABILITY OR FITNESS FOR A PARTICULAR PURPOSE ON THIS PRODUCT IS LIMITED TO THE APPLICABLE WARRANTY PERIOD SET FORTH ABOVE.

How State Law relates to warranty:

- Some states do not allow the exclusion nor limitation of incidental or consequential damages, or limitations on how long an implied warranty lasts, so the above limitations or exclusions may not apply to you.
- This warranty gives you specific legal rights, and you also may have other rights that vary from state to state.

If you purchased your unit outside the United States:

- This warranty does not apply. Contact your dealer for warranty information.

Service calls which do not involve defective materials or workmanship are not covered by this warranty. Costs of such service calls are the sole responsibility of the purchaser.

Limited Warranty (Canada)

EN

What your warranty covers:

- Defects in materials or workmanship.

For how long after your purchase:

- One year from date of purchase for labor and parts
- The warranty period for rental units begins with the first rental or 45 days from date of shipment to the rental firm, whichever comes first.

What we will do:

- Pay any Authorized RCA Audio Service Center the labor charges to repair your unit.
- Pay any Authorized RCA Audio Service Center for the new or, at our option, refurbished replacement parts required to repair your unit.

How you get service:

- Take your unit to any Authorized RCA Audio Service Center. To identify your nearest Authorized RCA Audio Service Center, ask your dealer, look in the Yellow Pages, or call 1-800-336-1900.
- Show the Authorized Service Center Representative your evidence of purchase date or first rental.
- Pick up your unit when repairs are completed.
- Proof of purchase in the form of a bill of sale or receipted invoice which is evidence that the product is within the warranty period must be presented to obtain warranty service. For rental firms, proof of first rental is also required.

What your warranty does not cover:

- Customer instruction. (Your Owner's Manual describes how to install, adjust, and operate your unit. Any additional information should be obtained from your dealer.)
- Installation and related adjustments.
- Signal reception problems not caused by your unit.
- Damage from misuse or neglect.
- Cleaning of audio heads.
- Batteries.
- A unit that has been modified or incorporated into other products or is used for institutional or other commercial purposes.
- A unit purchased or serviced outside Canada.
- Acts of nature, such as but not limited to lightning damage.

Limited Warranty (Canada)

EN Limitation of Warranty:

- THE WARRANTY STATED ABOVE IS THE ONLY WARRANTY APPLICABLE TO THIS PRODUCT. NO VERBAL OR WRITTEN INFORMATION GIVEN BY THOMSON MULTIMEDIA LTD., ITS AGENTS OR EMPLOYEES SHALL CREATE A GUARANTY OR IN ANY WAY INCREASE THE SCOPE OF THIS WARRANTY.
- REPAIR OR REPLACEMENT AS PROVIDED UNDER THIS WARRANTY IS THE EXCLUSIVE REMEDY OF THE CONSUMER. THOMSON MULTIMEDIA LTD. SHALL NOT BE LIABLE FOR INCIDENTAL OR CONSEQUENTIAL DAMAGES RESULTING FROM THE USE OF THIS PRODUCT. EXCEPT TO THE EXTENT PROHIBITED BY APPLICABLE PROVINCIAL LAW, ANY IMPLIED WARRANTY OF MERCHANTABILITY OR FITNESS FOR A PARTICULAR PURPOSE ON THIS PRODUCT IS LIMITED TO THE APPLICABLE WARRANTY PERIOD SET FORTH ABOVE.

How Provincial Laws relates to warranty:

- This warranty gives you specific legal rights which are in addition to statutory warranties that may vary from Province to Province.

If you purchased your unit outside Canada:

- This warranty does not apply. Contact your dealer for warranty information.

Service calls which do not involve defective materials or workmanship are not covered by this warranty. Costs of such service calls are the sole responsibility of the purchaser.