



Room Air Conditioners

Safety Instructions..... 2, 3
 Recycle Information3

Operating Instructions
 Controls 4-6

Care and Cleaning
 Air Filter7
 Outdoor Coils7

Installation Instructions..... 8-11

Troubleshooting Tips12
 Normal Operating Sounds12

Consumer Support
 Consumer Support Back Cover
 Warranty13

**Owner's Manual and
Installation Instructions**

AEV05

Acondicionador de aire

**Manual del propietario
y instrucciones de
instalación**

La sección en español empieza en la página 14

Write the model and serial numbers here:

Model # _____

Serial # _____

Find these numbers on a label on the side of the air conditioner.



IMPORTANT SAFETY INFORMATION.

READ ALL INSTRUCTIONS BEFORE USING.

SAFETY INFORMATION

 This is the safety alert symbol. This symbol alerts you to potential hazards that can kill or hurt you and others. All safety messages will follow the safety alert symbol and the word “DANGER”, “WARNING”, or “CAUTION”. These words are defined as:

 **DANGER** Indicates a hazardous situation which, if not avoided, **will** result in death or serious injury.

 **WARNING** Indicates a hazardous situation which, if not avoided, **could** result in death or serious injury.

 **CAUTION** Indicates a hazardous situation which, if not avoided, **could** result in minor or moderate injury.

WARNING

For your safety, the information in this manual must be followed to minimize the risk of fire, electric shock or personal injury.

SAFETY PRECAUTIONS

- Use this appliance only for its intended purpose as described in this Owner's Manual.
- This air conditioner must be properly installed in accordance with the Installation Instructions before it is used.
- Never unplug your air conditioner by pulling on the power cord. Always grip plug firmly and pull straight out from the receptacle.
- Replace immediately all electric service cords that have become frayed or otherwise damaged. A damaged power supply cord must be replaced with a new power supply cord obtained from the manufacturer and not repaired. Do not use a cord that shows cracks or abrasion damage along its length or at either the plug or connector end.
- Turn the unit **OFF** and unplug your air conditioner before cleaning.
- GE does not support any servicing of the air conditioner. We strongly recommend that you do not attempt to service the air conditioner yourself.
- For your safety...do not store or use combustible materials, gasoline or other flammable vapors or liquids in the vicinity of this or any other appliance.
- All air conditioners contain refrigerants, which under federal law must be removed prior to product disposal. If you are getting rid of an old product with refrigerants, check with the company handling disposal about what to do.
- If the receptacle does not match the plug, the receptacle must be changed out by a qualified electrician.
- These R410A air conditioning systems require contractors and technicians to use tools, equipment and safety standards approved for use with this refrigerant. DO NOT use equipment certified for R22 refrigerant only.

WARNING

HOW TO CONNECT ELECTRICITY

Do not, under any circumstances, cut or remove the third (ground) prong from the power cord. For personal safety, this appliance must be properly grounded.

DO NOT use an adapter plug with this appliance.

The power cord of this appliance is equipped with a 3-prong (grounding) plug which mates with a standard 3-prong (grounding) wall outlet to minimize the possibility of electric shock hazard from this appliance.

Power cord includes a current interrupter device. A test and reset button is provided on the plug case. The device should be tested on a periodic basis by first pressing the **TEST** button and then the **RESET** button while plugged into the outlet. If the **TEST** button does not trip or if the **RESET** button will not stay engaged, discontinue use of the air conditioner and contact a qualified service technician.

Have the wall outlet and circuit checked by a qualified electrician to make sure the outlet is properly grounded.

Where a 2-prong wall outlet is encountered, it is your personal responsibility and obligation to have it replaced with a properly grounded 3-prong wall outlet.

The air conditioner should always be plugged into its own individual electrical outlet which has a voltage rating that matches the rating plate.

This provides the best performance and also prevents overloading house wiring circuits which could cause a fire hazard from overheated wires.

See the Installation Instructions, *Electrical Requirements* section for specific electrical connection requirements.

USE OF EXTENSION CORDS

RISK OF FIRE. *Could cause serious injury or death.*

- *DO NOT* use an extension cord with this Window Air Conditioner.
- *DO NOT* use surge protectors or multi-outlet adaptors with this Window Air Conditioner.

READ AND FOLLOW THIS SAFETY INFORMATION CAREFULLY.

SAVE THESE INSTRUCTIONS

RECYCLING INFORMATION

For appliance recycling information please visit www.geappliances.com/recycling.

About the controls on the air conditioner.

Features and appearance will vary.

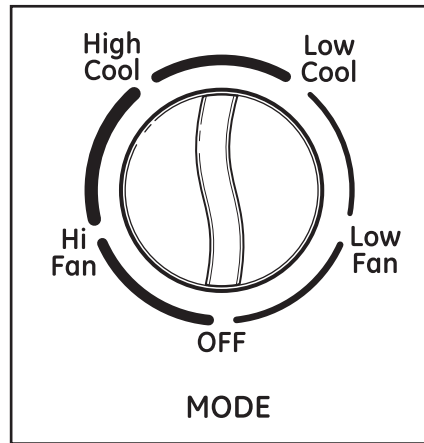

1 MODE CONTROL

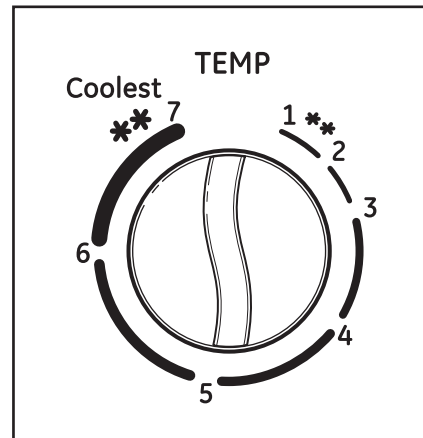

2 TEMPERATURE CONTROL

Controls

1 Mode Control

High Cool and **Low Cool** provide cooling with different fan speeds.

Fan settings provide air circulation and filtering without cooling.

NOTE: If you move the mode control from a cool setting to **OFF** or to a fan setting, wait at least 3 minutes before switching back to a cool setting.

Cooling Descriptions

For Normal Cooling—Select **High Cool** or **Low Cool** with the TEMPERATURE control at midpoint.

For Maximum Cooling—Select **High Cool** with the TEMPERATURE control at the highest number available on your knob.

For Quieter and Nighttime Cooling—Select **Low Cool** with the TEMPERATURE control at midpoint.

2 TEMP Control

The TEMP control is used to maintain the room temperature. The compressor will cycle on and off to keep the room at the same level of comfort. When you turn the knob to a higher number, the indoor air will become cooler. Turn the knob to a lower number and the indoor air will become warmer.

Do Not Operate in Freezing Outdoor Conditions

This cool-only air conditioner was not designed for freezing outdoor conditions. It must not be used in freezing outdoor conditions.

Remote Control

- To ensure proper operation, aim the remote control at the signal receiver on the air conditioner.
 - Make sure nothing is between the air conditioner and the remote control that could block the signal.
 - The remote control signal has a range of up to 20 feet.
 - Make sure batteries are fresh and installed correctly as indicated on the remote control.
 - Remote contains a magnet allowing it to attach to metal surfaces.
-

Air Direction

Use the lever to adjust the air direction left and right only.

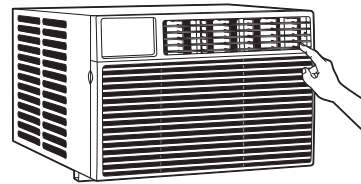

Care and cleaning of the air conditioner.

Grille and Case

Turn the air conditioner off and remove the plug from the wall outlet before cleaning.

To clean, use water and a mild detergent. Do not use bleach or abrasives.

Air Filter

The air filter behind the front grille should be checked and cleaned at least every 30 days or more often if necessary.

To remove:

Pull the tab on the right side of the unit until the filter is out.

To remove:

Open the inlet grille by pulling downward on the tabs at the top upper corners of the inlet grille until the grille is in a 45° position. Remove the filter.

Clean the filter with warm, soapy water. Rinse and let the filter dry before replacing it. Do not clean the filter in a dishwasher.

⚠ CAUTION: *DO NOT operate the air conditioner without a filter because dirt and lint will clog it and reduce performance.*

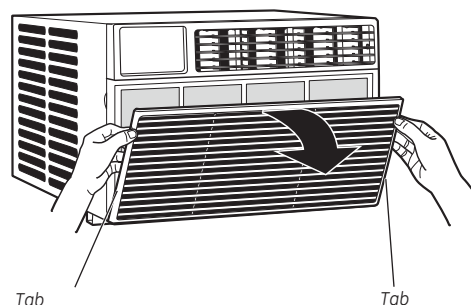
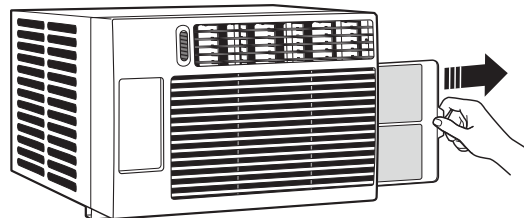

Outdoor Coils

The coils on the outdoor side of the air conditioner should be checked regularly. If they are clogged with dirt or soot, they may be professionally cleaned.

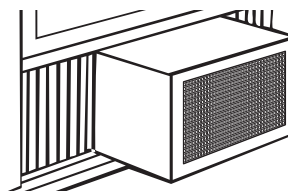

How to Insert the Batteries in the Remote Control

- 1 Remove the battery cover by sliding it according to the arrow direction.
- 2 Insert new batteries, making sure that the (+) and (-) of battery are installed correctly.
- 3 Reattach the cover by sliding it back into position.

NOTES:

- Use 2 "AAA" (1.5 volt) alkaline batteries. Do not use rechargeable batteries.
- Remove the batteries from the remote control if the system is not going to be used for a long time.
- Do not mix old and new batteries. Do not mix alkaline, standard (carbon-zinc) or rechargeable (ni-cad, ni-mh, etc) batteries.

Installation Instructions

Air Conditioner

? Questions? Call 800.GE.CARES (800.432.2737) or Visit our Website at: GEAppliances.com
In Canada, call 1.800.561.3344 or visit www.GEAppliances.ca

BEFORE YOU BEGIN

Read these instructions completely and carefully.

- **IMPORTANT** — Save these instructions for local inspector's use.
- **IMPORTANT** — Observe all governing codes and ordinances.
- **Note to Installer** – Be sure to leave these instructions with the Consumer.
- **Note to Consumer** – Keep these instructions for future reference.
- **Skill level** – Installation of this appliance requires basic mechanical skills.
- **Completion time** – Approximately 1 hour
- We recommend that two people install this product.
- Proper installation is the responsibility of the installer.
- Product failure due to improper installation is not covered under the Warranty.
- You **MUST** use all supplied parts and use proper installation procedures as described in these instructions when installing this air conditioner.

ELECTRICAL REQUIREMENTS

 Some models require a 115/120-volt AC, 60-Hz grounded outlet protected with a 15-amp time-delay fuse or circuit breaker.

The 3-prong grounding plug minimizes the possibility of electric shock hazard. If the wall outlet you plan to use is only a 2-prong outlet, it is your responsibility to have it replaced with a properly grounded 3-prong wall outlet.

 Some models require 230/208-volt AC, protected with a time-delay fuse or circuit breaker. These models should be installed on their own single branch circuit for best performance and to prevent overloading house or apartment wiring circuits, which could cause a possible fire hazard from overheating wires.

CAUTION:

Do not, under any circumstances, cut or remove the third (ground) prong from the power cord.

Do not change the plug on the power cord of this air conditioner.

Aluminum house wiring may present special problems—consult a qualified electrician.

TOOLS YOU WILL NEED

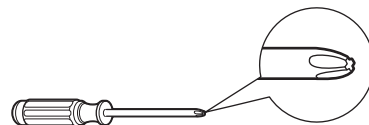

Phillips head screwdriver



Flat-blade screwdriver



Pencil

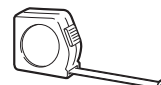

Ruler or tape measure



Level

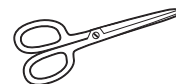

Scissors or knife

Power cord includes a current interrupter device. A test and reset button is provided on the plug case. The device should be tested on a periodic basis by first pressing the **TEST** button and then the **RESET** button while plugged into the outlet. If the **TEST** button does not trip or if the **RESET** button will not stay engaged, discontinue use of the air conditioner and contact a qualified service technician.

Installation Instructions

PARTS INCLUDED (Appearance may vary)

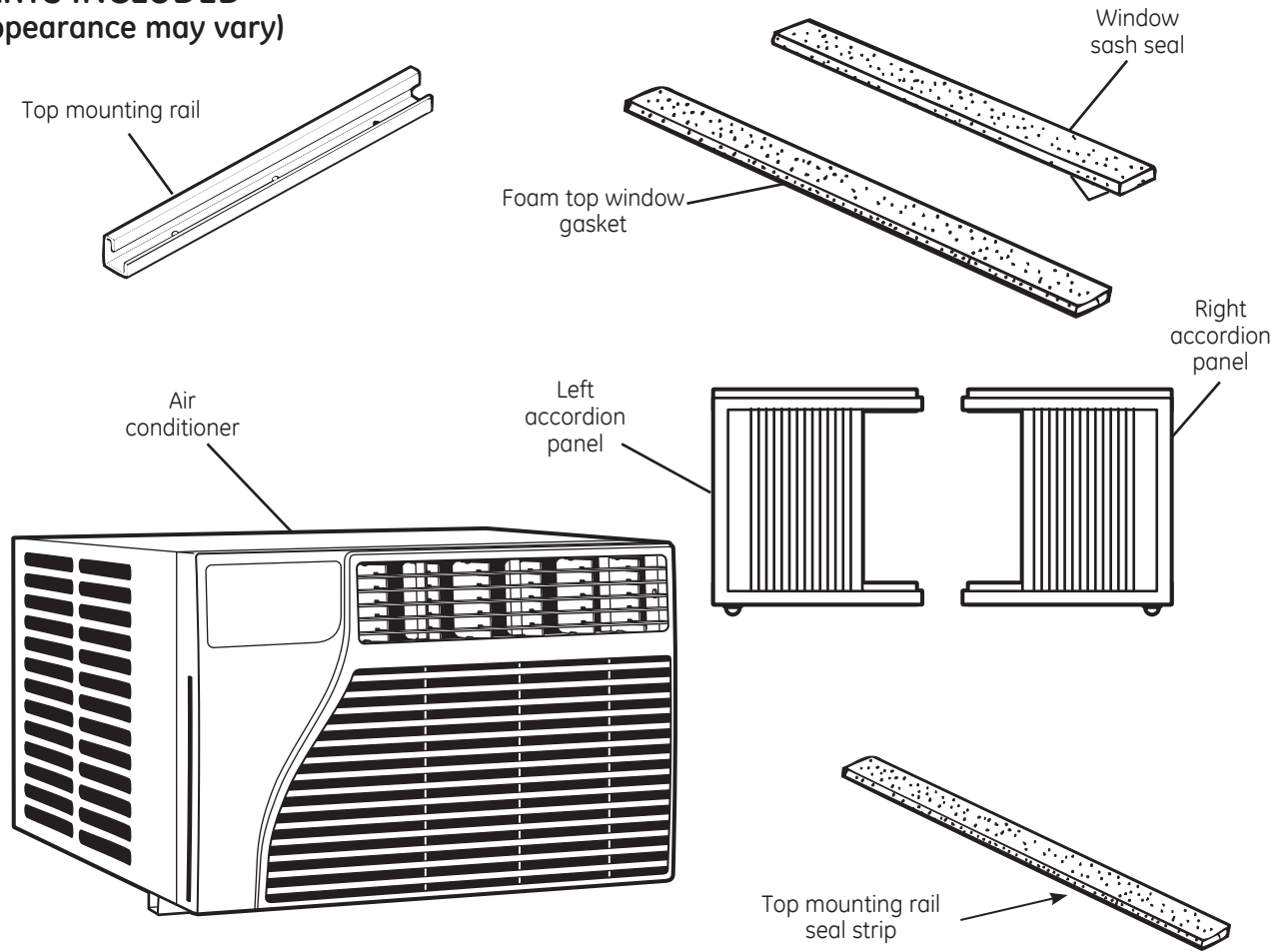

Type A (4)

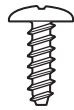

Type B (6)

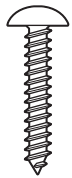

Window locking bracket (1)

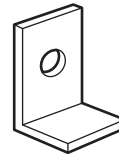

Installation Instructions

1 WINDOW REQUIREMENTS

- These instructions are for a standard double-hung window. You will need to modify them for other types of windows.
- The air conditioner can be installed without the accordion panels if needed to fit in a narrow window. See the window opening dimensions.
- All supporting parts must be secured to firm wood, masonry or metal.
- The electrical outlet must be within reach of the power cord.
- Follow the dimensions in the table and illustration for your model.

Models	A	B
AET05, AEY05 AEW05, AEZ05	12 1/2" min.	23"-38"
AEW06, AEZ06 AEW08, AEZ08	13 1/2" min.	22 1/2"-38"

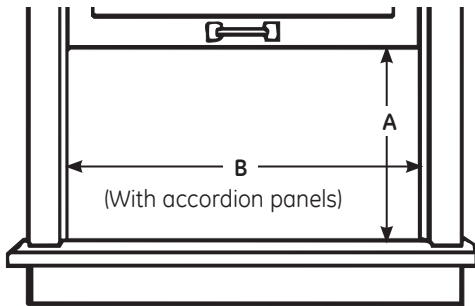

2 STORM WINDOW REQUIREMENTS

A storm window frame will not allow the air conditioner to tilt toward the outside, and will keep it from draining properly.

To adjust for this, attach a piece of wood to the sill.

WOOD PIECES

WIDTH: 2"

LENGTH: Long enough to fit inside the window frame.

THICKNESS: To determine the thickness, place a piece of wood on the sill to make it 1/2" higher than the top of the storm window frame or the vinyl frame.

Attach securely with nails or screws provided by the installer.

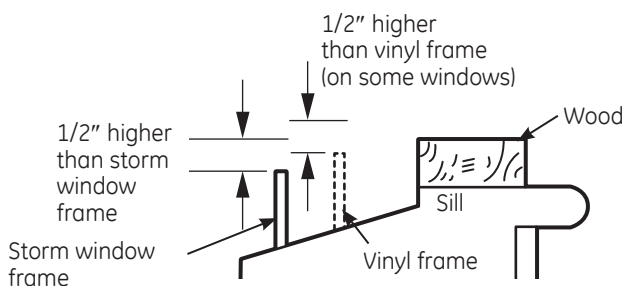

3 ATTACH THE TOP MOUNTING RAIL SEAL STRIP

(Some models may have the seal strip already attached to the top mounting rail. If applicable, skip this step.)

Remove the backing from the top mounting rail seal strip and attach the seal strip to the bottom of the top mounting rail, along the front edge.

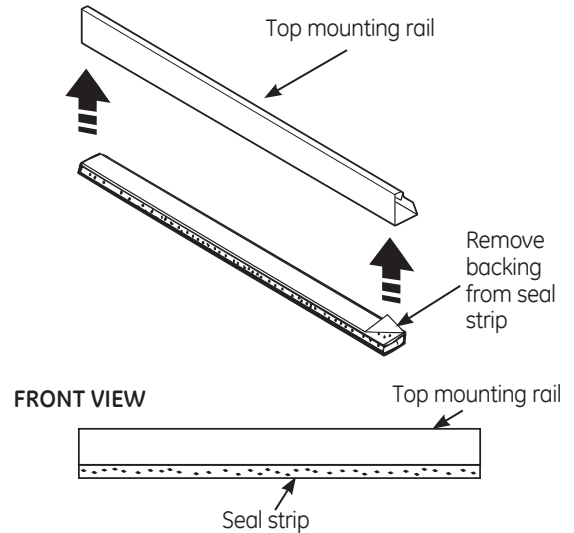

4 PREPARE THE AIR CONDITIONER

- A** Install the top mounting rail with 4 Type A screws from the outside of the case.

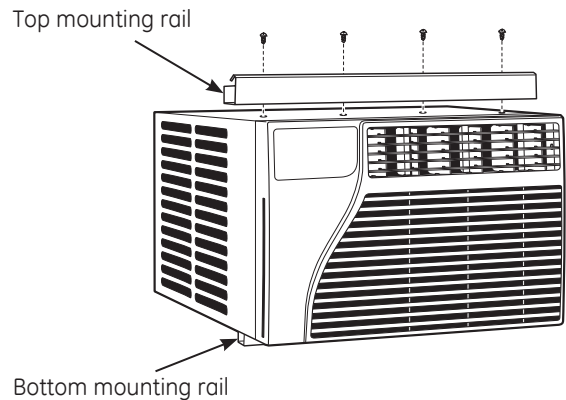

- B** Hold the accordion panel in one hand and gently pull back to free the open end.

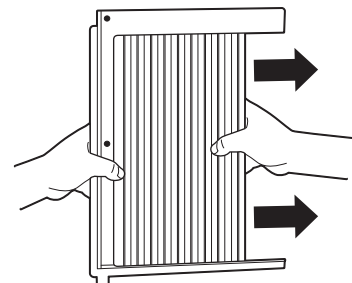

Installation Instructions

4 PREPARE THE AIR CONDITIONER (cont.)

- C** Slide the free end of the accordion panel into the side panel rails. Slide the panel down. Be sure to leave enough space to slip the top and bottom of the frame into the rails on the cabinet.

NOTE: There is a right and a left accordion panel. Be sure to use the proper panel for each side.

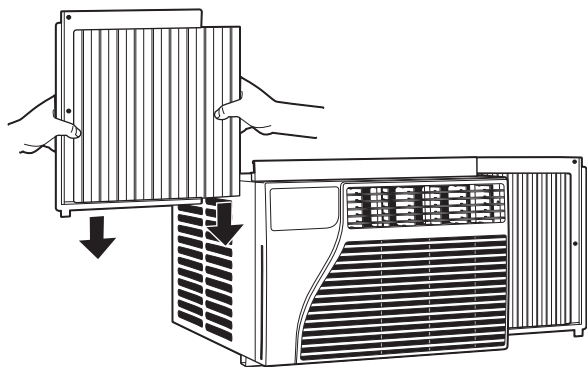

- D** Slide the left and right accordion panels into the top and bottom mounting rails.

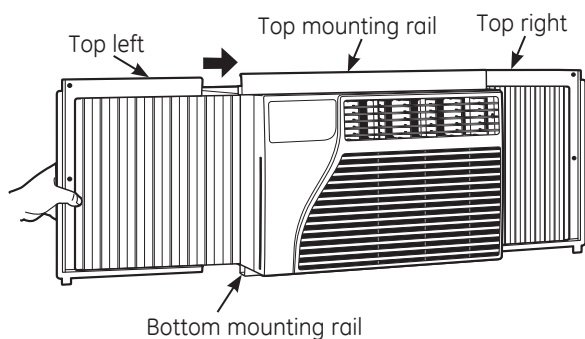

5 PREPARE THE WINDOW

Cut the window sash seal to the proper length. Peel off the backing and attach the seal to the underside of the window sash.

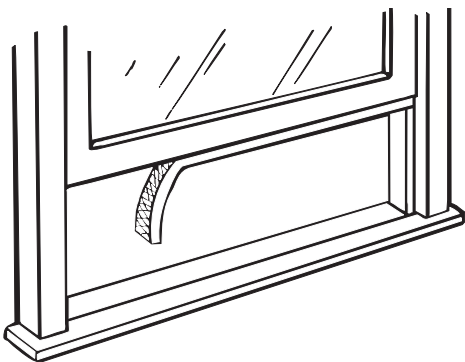

6 INSTALL THE AIR CONDITIONER IN THE WINDOW

- A** Place the air conditioner on the sill with the bottom mounting rail against its back edge. Center it and close the window securely behind the top mounting rail. It should be level or slightly tilted to the outside. Use a level; about a 1/3 bubble will be the correct case slant to the outside.

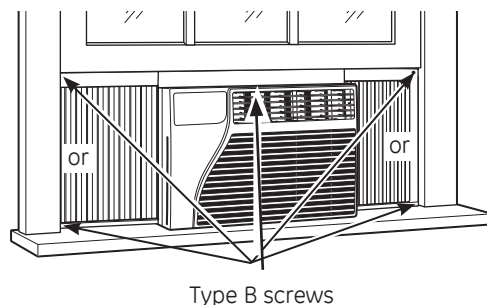

- B** Extend the left and right accordion panels to the vertical window sashes and attach, through the holes in the panels, with 5 Type B screws, as appropriate.

7 INSTALL SUPPORT BRACKET AND FOAM TOP WINDOW GASKET

A CAUTION:

To prevent broken glass or damage to windows, on vinyl or other similarly constructed windows, attach the window locking bracket to the window side jamb with one Type B screw.

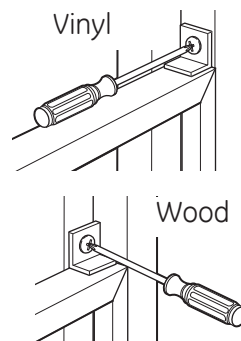

- B** Cut the foam top window gasket to the window width.

- C** Stuff the foam between the glass and the window to prevent air and insects from getting into the room.

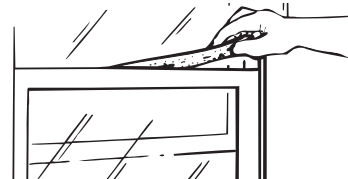

NOTE: If the gasket supplied does not fit your window, obtain appropriate material locally to provide a proper installation seal.

Troubleshooting Tips.

Problem	Possible Causes	What To Do
Air conditioner does not start	The air conditioner is unplugged.	<ul style="list-style-type: none"> • Make sure the air conditioner plug is pushed completely into the outlet.
	The fuse is blown/circuit breaker is tripped.	<ul style="list-style-type: none"> • Check the house fuse/circuit breaker box and replace the fuse or reset the breaker.
	Power failure.	<ul style="list-style-type: none"> • The unit will automatically restart in the settings last used after the power is restored. • There is a protective time delay (approximately 3 minutes) to prevent tripping of the compressor overload. For this reason, the unit may not start normal cooling for 3 minutes after it is turned back on.
	The current interrupter device is tripped.	<ul style="list-style-type: none"> • Press the RESET button located on the power cord plug. • If the RESET button will not stay engaged, discontinue use of the air conditioner and contact a qualified service technician.
Air conditioner does not cool as it should	Airflow is restricted.	<ul style="list-style-type: none"> • Make sure there are no curtains, blinds or furniture blocking the front of the air conditioner.
	The temp control may not be set correctly.	<ul style="list-style-type: none"> • On models with touch pads: In the Cool mode, press the Decrease – pad. • On models with control knobs, turn the temperature knob to a higher number.
	The air filter is dirty.	<ul style="list-style-type: none"> • Clean the filter at least every 30 days. See the <i>Care and Cleaning</i> section.
	The room may have been hot.	<ul style="list-style-type: none"> • When the air conditioner is first turned on, you need to allow time for the room to cool down.
	Cold air is escaping.	<ul style="list-style-type: none"> • Check for open furnace registers and cold air returns.
	Cooling coils have iced up.	<ul style="list-style-type: none"> • See "Air conditioner freezing up" below.
Air conditioner freezing up	Ice blocks the air flow and stops the air conditioner from cooling the room.	<ul style="list-style-type: none"> • On models with control knobs, set the mode control at High Fan or High Cool with the Temp at 1 or 2. • On models with touch pads, set the controls at High Fan or High Cool and set the thermostat to a higher temperature.
The remote control is not working	The batteries are inserted incorrectly.	<ul style="list-style-type: none"> • Check the position of the batteries. They should be inserted in the opposite (+) and (-) direction.
	The batteries may be dead.	<ul style="list-style-type: none"> • Replace the batteries.
Water drips outside	Hot, humid weather.	<ul style="list-style-type: none"> • This is normal.
Water drips indoors	The air conditioner is not tilted to the outside.	<ul style="list-style-type: none"> • For proper water disposal, make sure the air conditioner slants slightly from the case front to the rear.
Water collects in base pan	Moisture removed from air and drains into base pan.	<ul style="list-style-type: none"> • This is normal for a short period in areas with little humidity; normal for a longer period in very humid areas.

Normal Operating Sounds

- You may hear a pinging noise caused by water being picked up and thrown against the condenser on rainy days or when the humidity is high. This design feature helps remove moisture and improve efficiency.
- You may hear the thermostat click when the compressor cycles on and off.
- Water will collect in the base pan during high humidity or on rainy days. The water may overflow and drip from the outdoor side of the unit.
- The fan may run even when the compressor does not.

Notes.

GE Air Conditioner—One-Year Limited Warranty. (For customers in the U.S.A.)

Staple your receipt here.

Proof of the original purchase date is needed to make a warranty claim.

For The Period Of:	We Will Replace:
One Year From the date of the original purchase	Replacement unit for any product which fails due to a defect in materials or workmanship. The replacement unit is warranted for the remainder of your product's original one-year warranty period.

In Order to Make a Warranty Claim:

- Properly pack your unit. We recommend using the original carton and packing materials.
- Return the product to the retail location where it was purchased.
- Include in the package a copy of the sales receipt or other evidence of date of original purchase. Also print your name and address and a description of the defect.

What Is Not Covered:

- Customer instruction. This owner's manual provides information regarding operating instructions and user controls.
- Improper installation, delivery or maintenance. If you have an installation problem, or if the air conditioner is of improper cooling capacity, contact your dealer or installer. You are responsible for providing adequate electrical, plumbing and other connecting facilities.
- Failure of the product resulting from modifications to the product or due to unreasonable use, including failure to provide reasonable and necessary maintenance.
- Replacement of house fuses or resetting of circuit breakers.
- Failure due to corrosion on models not corrosion-protected.
- Damage to the product caused by improper power supply voltage, accident, fire, floods or acts of God.
- Incidental or consequential damage caused by possible defects with this air conditioner.
- Damage caused after delivery.

EXCLUSION OF IMPLIED WARRANTIES—Your sole and exclusive remedy is product replacement as provided in this Limited Warranty. Any implied warranties, including the implied warranties of merchantability or fitness for a particular purpose, are limited to one year or the shortest period allowed by law.

This warranty is extended to the original purchaser and any succeeding owner for products purchased for home use within the USA.

Some states do not allow the exclusion or limitation of incidental or consequential damages. This warranty gives you specific legal rights, and you may also have other rights which vary from state to state. To know what your legal rights are, consult your local or state consumer affairs office or your state's Attorney General.

Exclusion of implied warranties: Except where prohibited or restricted by law, there are no warranties, whether express, oral or statutory which extend beyond the description on the face hereof, including specifically the implied warranties of merchantability or fitness for a particular purpose.

Warrantor: General Electric Company. Louisville, KY 40225

Consumer Support.



GE Appliances Website

In the U.S.A.: GEAppliances.com

Have a question or need assistance with your appliance? Try the GE Appliances Website 24 hours a day, any day of the year! For greater convenience and faster service, you can now download Owner's Manuals, or even order parts on-line. **In Canada: www.GEAppliances.ca**



Real Life Design Studio

In the U.S.A.: GEAppliances.com

GE supports the Universal Design concept—products, services and environments that can be used by people of all ages, sizes and capabilities. We recognize the need to design for a wide range of physical and mental abilities and impairments. For details of GE's Universal Design applications, including kitchen design ideas for people with disabilities, check out our Website today. For the hearing impaired, please call 800.TDD.GEAC (800.833.4322).

In Canada, contact: Manager, Consumer Relations, Mabe Canada Inc.
Suite 310, 1 Factory Lane
Moncton, N.B. E1C 9M3

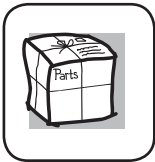

Parts and Accessories

In the U.S.A.: GEAppliances.com

Individuals qualified to service their own appliances can have parts or accessories sent directly to their homes (VISA, MasterCard and Discover cards are accepted). Order on-line today, 24 hours every day or by phone at 800.626.2002 during normal business hours.

Instructions contained in this manual cover procedures to be performed by any user. GE does not support any servicing of the air conditioner. We strongly recommend that you do not attempt to service the air conditioner yourself.

Customers in **Canada** should consult the yellow pages for the nearest Mabe service center, or call 1.800.561.3344.



Contact Us

In the U.S.A.: GEAppliances.com

If you are not satisfied with the service you receive from GE, contact us on our Website with all the details including your phone number, or write to:

General Manager, Customer Relations
GE Appliances, Appliance Park
Louisville, KY 40225

In Canada: www.GEAppliances.ca, or write to: Director, Consumer Relations, Mabe Canada Inc.
Suite 310, 1 Factory Lane
Moncton, N.B. E1C 9M3