

EN

# DETAILED INSTRUCTIONS

## HOW TO USE YOUR DRYER

**gorenje**

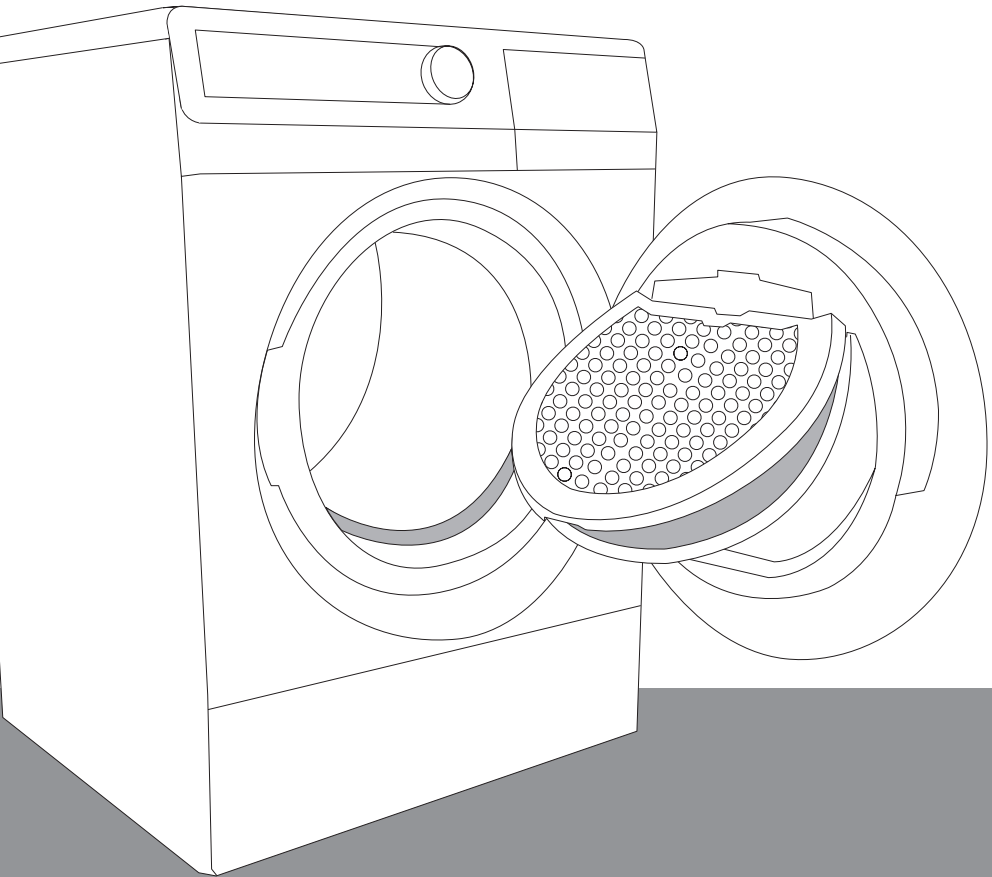

[www.gorenje.com](http://www.gorenje.com)

We thank you for the confidence you have shown us by purchasing this dryer. Your new dryer complies with the requirements of modern laundry care; it will dry your laundry quickly, leaving it soft and smooth, while use of special programs will not deform it. **SenzoCare** technology will allow simple operation of the dryer with very low power consumption. This appliance is designed exclusively for household use for clothes which may be drying in a dryer.

# TABLE OF CONTENTS

<b>4 APPLIANCE</b> 5 Technical information 6 Control panel description .....	<b>INTRODUCTION</b>
<b>8 SAFETY PRECAUTIONS</b>	
<b>10 INSTALLATION AND CONNECTION</b> 10 Selecting the room 13 Installation 14 Moist air evacuation 15 Condensate discharge 16 Electrical connections 17 Moving and transport 17 Subsequent transport  <b>18 BEFORE THE FIRST USE</b>	<b>GETTING STARTED</b>
<b>19 DRYING STEPS (1 - 6)</b> 19 1. Step: Check the tags on your laundry 20 2. Step: Preparing the laundry 23 3. Step: Selecting a program 25 4. Step: Additional functions (extra) 27 5. Step: Program start-up 27 6. Step: End of drying cycle .....	<b>DRYING STEPS</b>
<b>28 CLEANING AND MAINTENANCE</b> 29 Cleaning the filter on the lower side of the door opening 30 Cleaning the net filter in the door 31 Cleaning of water condenser 33 Emptying the condensate tank 34 Cleaning of evacuation duct 34 Cleaning the dryer	<b>CLEANING AND MAINTENANCE OF THE APPLIANCE</b>
<b>35 INTERRUPTING AND CHANGING THE PROGRAM</b> 36 What to do...? .....	<b>TROUBLE-SHOOTING</b>
<b>38 TIPS AND RECOMMENDATIONS FOR DRYING AND ECONOMIC USE OF YOUR DRYER</b> <b>39 DISPOSAL</b> <b>40 TYPICAL CONSUMPTION TABLE</b>	<b>OTHER</b>

# APPLIANCE

## (DRYER DESCRIPTION)

### FRONT

- 1 Program selector dial
- 2 Control panel
- 3 Condensate tank  
(depending on the model)
- 4 Door
- 5 Net filter
- 6 Filter on the lower side  
of the door opening  
(depending on the model)
- 7 Condenser  
(depending on the model)
- 8 Evacuation opening  
(depending on the model)
- 9 Rating plate

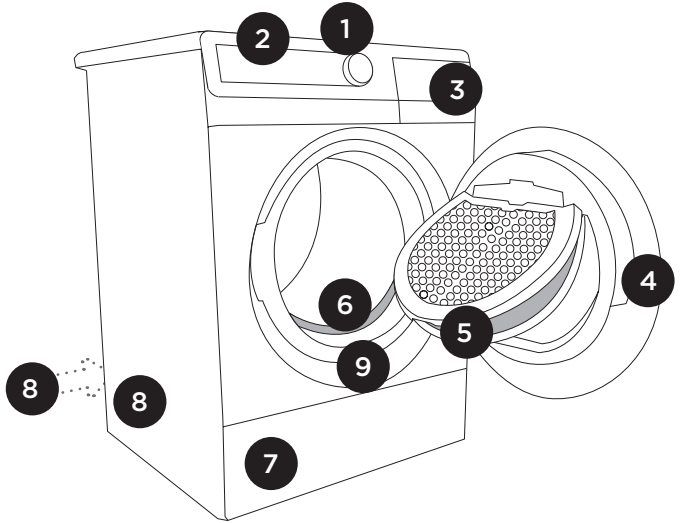

### BACK

- 1 Condensate discharge pipe  
(depending on the model)
- 2 Evacuation opening  
(depending on the model)
- 3 Power cord
- 4 Adjustable feet

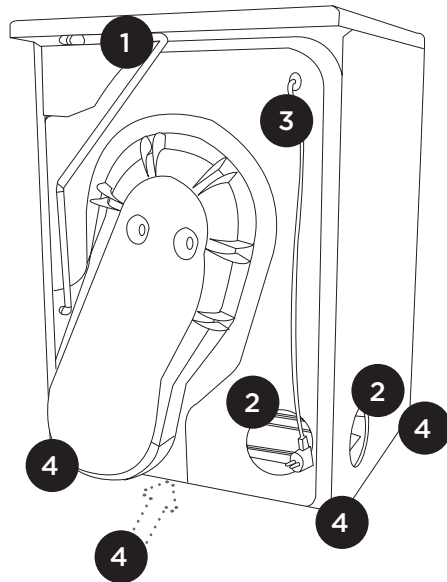

# TECHNICAL INFORMATION

(DEPENDING ON THE MODEL)

The rating plate with the basic information on the dryer is located under the door frame.

<b>Width</b>	600mm
<b>Height</b>	850mm
<b>Depth</b>	600mm
<b>Depth with door open</b>	1100mm
<b>Weight</b>	XX/YY kg (depending on the model)
<b>Rated voltage</b>	See rating plate
<b>Fuse</b>	See rating plate
<b>Nominal power</b>	See rating plate
<b>Maximum load</b>	See rating plate

The rating plate

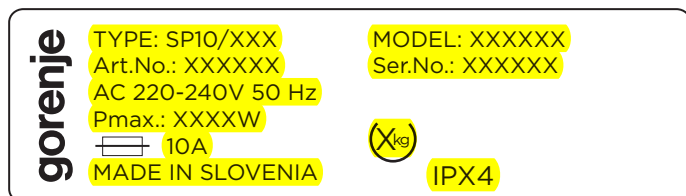

# CONTROL PANEL DESCRIPTION FOR MODELS A) CONDENSATION AND B) AIR VENTED

## A) CONDENSATION

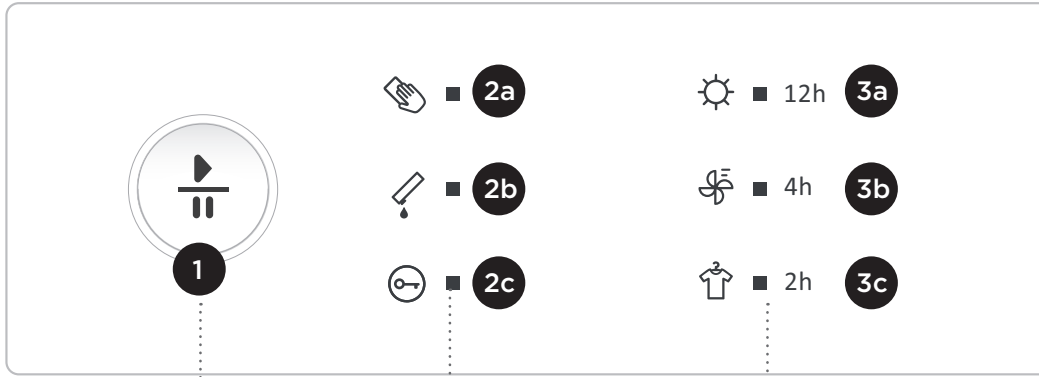

START | PAUSE

**1 START/ PAUSE key,** use this key to start or stop the program. When selected, the signal light on the key will flash. When the program has started it will be lit continuously.

**2 a, b, c: SIGNAL LIGHTS are on:** when it is necessary to clean the filter, empty the condensate tank (depending on the model) or when the child lock is on.

**3 LAMPS** indicating delayed start of the operation, or display of drying, cooling, and end of drying stages.

## B) AIR VENTED

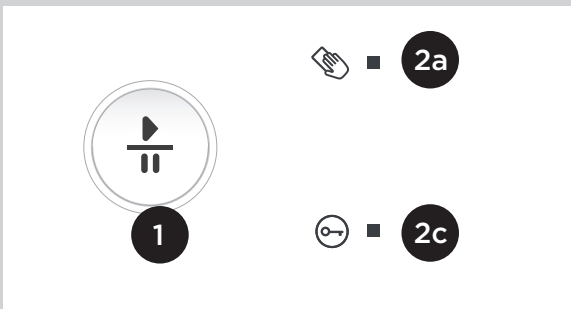

START | PAUSE

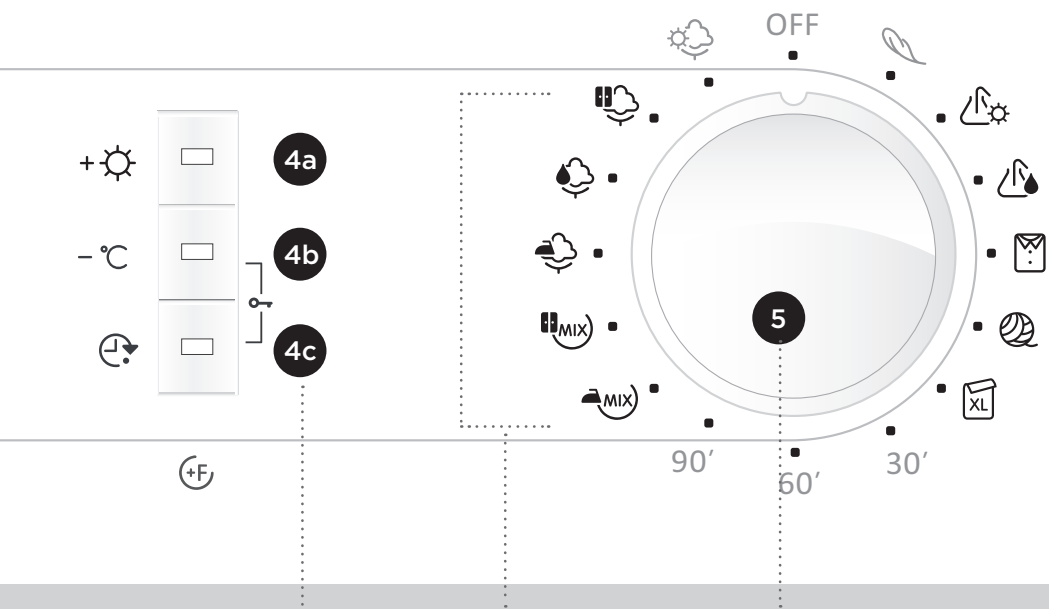

**4** a, b, c: **ADDITIONAL FUNCTION** keys, to extend or adjust the basic programs.

**MOST USED PROGRAMS**

**5** **ON/OFF** and **PROGRAM SELECTOR** dial

# SAFETY PRECAUTIONS



**Please don't use the appliance unless you have studied and understood the instruction manual.**

**Your dryer is intended solely for household use.**

If the dryer is used for professional, for-profit purpose or purpose exceeding normal use in a household, or if the dryer is used by a person who is not a consumer, the warranty period shall be equal to the shortest warranty period required by relevant legislation.

**Before connecting the dryer to the power mains, please read carefully the instructions for use which describe the dryer and its correct and safe use. The instructions apply for several appliance types/models; thus, settings or equipment may be described herein which is not available in your dryer.**

**Failure to observe instructions or incorrect use of the dryer, can lead to damage of laundry, dryer or the user.**

**Store the instruction manual nearby the dryer.**

**Do not allow the children to play with the appliance.**

Prevent your children and pets to enter the dryer drum.

**Air in the dryer environment should not contain dust particles.**

**The air where the dryer is installed, should be well ventilated to prevent feedback of gases released from the gas appliances with open fire (e.g. fireplace).**

**Clean the filters after each drying cycle.** If you have removed the filters, replace them before the next drying cycle.

**After each cleaning insert the condenser back into the air duct (depending on model).** Operation of the appliance without condenser, or with damaged condenser is extremely dangerous and may cause fire.

**Always switch off the dryer after use** (the program selector switch should be in the "OFF" position) and unplug the power cord from the wall outlet (to prevent the hazard of lightning or voltage overload).

**Leave any repairs and similar tasks on the dryer to an expert.**

Unprofessional repair may result in an accident or major malfunction. Call the authorized service department (see list of service departments attached).

**The warranty does not cover** (consumables (light bulbs), minor deviations in colour, increased noise which is a consequence of the appliance age and does not affect the functionality of the appliance, and aesthetic defects on components that do not affect the functionality and safety of the appliance).

**The appliance is manufactured in compliance with all effective safety standards.**

**Nevertheless, we recommend it is not used by persons with impaired physical or mental abilities and motor skills, or persons with deficient experience or knowledge, without due supervision. The same recommendation applies to the use of appliance by minors.**

The dryer back wall can be hot danger of burns.

Final drying cycle includes cooling; be careful not to extract excessively hot laundry from the drum.

Never stop the drying cycle before it is completed; if you do interrupt the cycle for any reason, be careful when removing the laundry from the drum as it is very hot. Quickly remove the laundry from the drum and spread it to allow it to cool down as quickly as possible.

## TO REDUCE FIRE HAZARD, PLEASE READ THE FOLLOWING INSTRUCTIONS:



Do not dry in the dryer any laundry, that has not been washed earlier.

Use the dryer only to dry laundry that was washed with water. Do not dry any laundry that was washed or cleaned with inflammable cleaners or substances (such as gasoline, trichloroethylene etc.) as this may result in an explosion.

Laundry stained with oil, acetone, alcohol, oil derivatives, stain removers, turpentine, wax, and wax removers should be washed in a washing machine with hot water and detergent before it is dried in the dryer.

Clothing that includes foam rubber, latex, rubber parts, shower and bathing caps, water proof textiles, and rubber backed articles and clothes or pillows fitted with foam rubber pads should not be dried in the tumble dryer

Laundry conditioners or similar products have to be used in compliance with manufacturer's instructions.

# INSTALLATION AND CONNECTION

## SELECTING THE ROOM

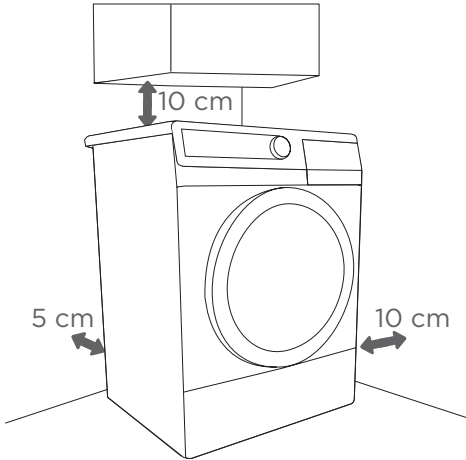

Ventilation slots and the opening on the front and rear side should always be kept free.

When installing the dryer in a room, note the required clearance as indicated in the image. In case of failure to heed the required minimum clearance, the dryer may overheat.

### For condensation dryer

Do not install the appliance in a room where there is danger of frost. The room in which the appliance is installed should be adequately ventilated, with temperature between 10°C and 25°C. When the dryer is operated at a lower ambient temperature, condensate can accumulate in the appliance interior. Frozen water in the condensate tank or pump may damage the dryer.

### For vented dryer

Place the appliance in well aerated room with a window or fitted with a fan. Put the evacuation tube into the appropriate opening. Evacuation duct may not be placed into the chimney or other type of air duct used for evacuation of exhaust fumes and smoke of appliances using other combustible substances.

Exhaust air must not be discharged into a flue which is used for exhausting fumes from appliances burning gas or other fuels

# POSITIONING THE APPLIANCE

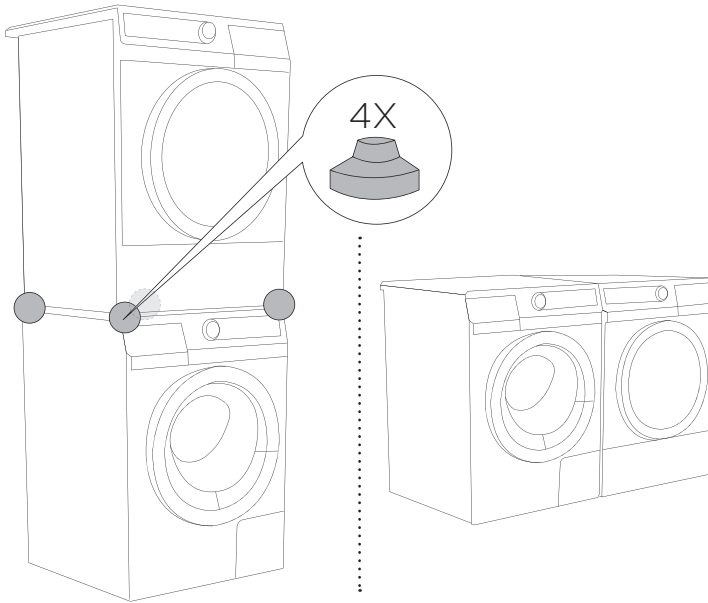

Positioning the appliance on top of the washing machine by using the vacuum feet or side by side.

Dryer can be stand freely on the floor or on a washing machine of the same dimensions - minimum width 517 mm, minimum depth 476 mm. The surface on which the dryer is placed should be clean and level.

Use the vacuum feet attached; they are designed to prevent the dryer from sliding. (Vacuum feet are attached or can be purchased (depending on model))

Washing machine on which you wish to install the dryer must be able to bear the weight of the dryer (see washing machine's rating plate or technical information).



**Do not place the dryer behind lockable or sliding door or door with a hinge opposite the dryer. Install the dryer in such way that the door can always be freely opened.**

Air ventilation duct must be kept unobstructed (see "Description of the appliance").

Drying machine on top should be placed by at least two persons.

Do not place the dryer on a carpet with long fibres as this may impede air circulation.

The appliance may not be in contact with a wall or adjacent furniture.

# INSTALLATION

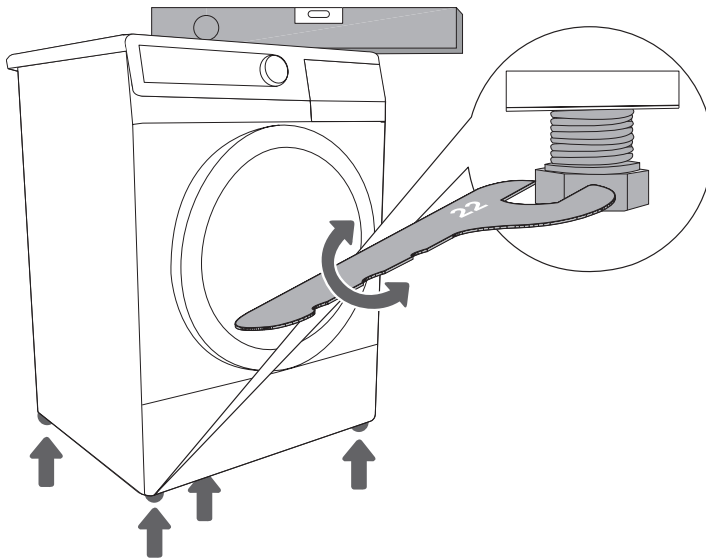

.....  
Level the dryer in longitudinal and traverse direction by rotating the adjustable feet which allow levelling by +/- 1 cm. Use key nr. 22 and spirit level.



Floor on which the machine is placed must have a concrete base. They must be clean and dry; otherwise, the machine may slide. Also clean the adjustable feet.

The appliance must stand level and stable on a solid base.

Vibrations, moving of the appliance across the room, or loud operation due to improperly adjusted feet are not covered by the warranty.

Sometimes, unusual or loud noise may appear during appliance operation; these are mostly the result of improper installation.

# MOIST AIR EVACUATION

## (For vented dryer)

The appliance is fitted with two openings for moist air evacuation (option a/b), of which one must be covered with the lid, and other used to fix the exhaust tube.

**a**

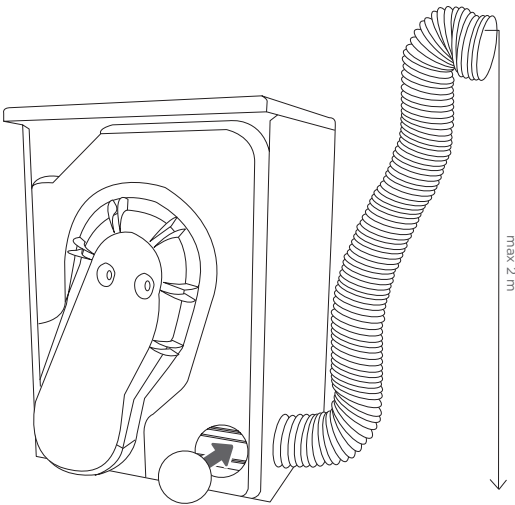

**b**

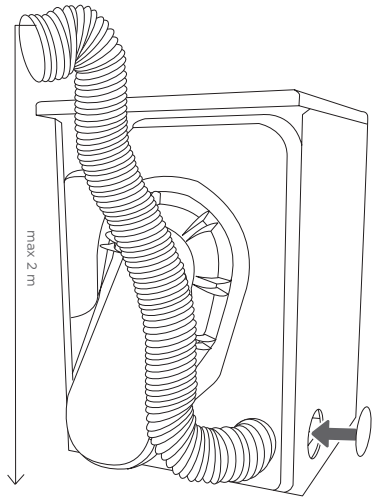

**Lint must not be allowed to accumulate around the tumble dryer**



Distance between the drying machine and the evacuation opening (vent duct, window) may not be more than 2 m, otherwise you may expect concentration of moisture within the exhaust tube.

# CONDENSATE DISCHARGE

## (For condensation dryer)

The moisture from the laundry is extracted in the condenser unit and accumulated in the condensate tank.

During the drying process, a control light will warn you of a full condensate tank which has to be emptied.

Interruption of the drying cycle due to full condensate tank can be avoided by running the condensate discharge tube found at the back of the appliance directly into a drain.

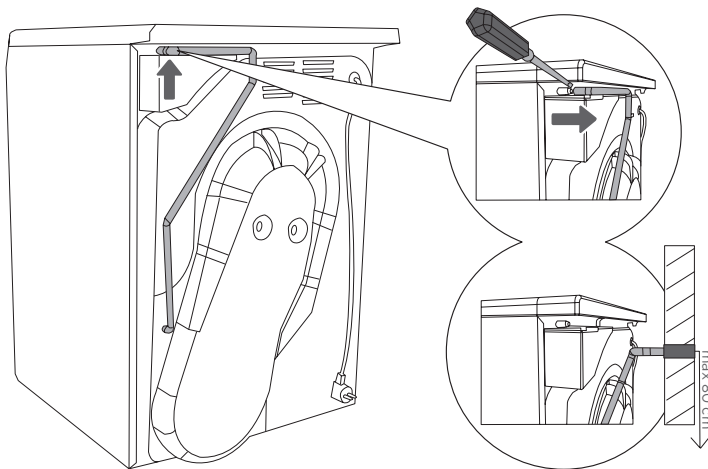

.....  
**1** Pull the tube to remove it with flat screw-driver, from the holder on the appliance back wall.(on the left hand side under the cover).  
.....

**2** Install tube into the drain, at a height of 80 cm from the ground.



**If the condensate discharge tube is run into a drain, make sure the tube is firmly secured. This will prevent any water spillage which could result in unexpected damage.**

**In this case, the steam generator tank will not be filled automatically. It will always require manual filling (see section Filling and replenishing the steam generator tank).**

# ELECTRICAL CONNECTIONS

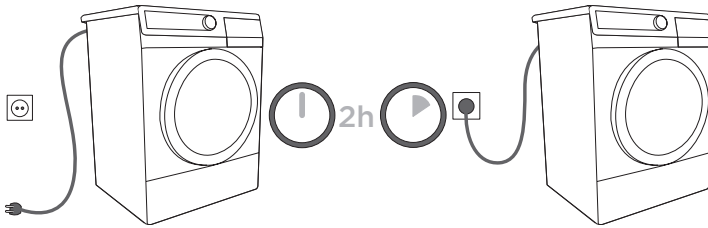

**The dryer should be left to stand still for at least two hours before it is connected to the power mains to allow the system to stabilize.**

Use the power cord to connect the dryer to the power mains through a power outlet. The dryer may not be connected to the power mains through an extension cable (danger of overheating and fire). Nominal voltage and other information is given on the rating plate located under the door frame.

To prevent from damage by excess voltage on the mains due to lightning strike we recommend to use a class I over-voltage protector between the machine and the mains.



After installation, the wall outlet should be freely accessible. The outlet should be fitted with an earth contact (in compliance with the relevant regulations).

**A damaged power cord may only be replaced by a person authorized by the manufacturer.**

# MOVING AND TRANSPORT



After transport, the dryer should be left to stand still for at least two hours before it is connected to the power mains to allow the system to stabilize. We recommend that installation and connection should be done by a qualified person.

## SUBSEQUENT TRANSPORT

After each drying certain amount of condensed water is retained in the appliance. Switch on the appliance and choose one of the programs, then let the appliance operate for approximately half a minute. This will pump out the remaining water and prevent damage to the dryer during transport.



If the appliance was not transported in compliance with the instructions, the dryer should be left to stand still at least two hours before it is reconnected to the power mains.

Before connecting the appliance, read the instructions for use. Repair or any warranty claim resulting from incorrect connection or use of the appliance shall not be covered by the warranty.

The belt can be replaced by a servicing engineer only, who incorporates an original spare part with the marking OPTIBELT EPH 1906, code 104265, OPTIBELT 8 EPH 1941, code 160165 (depending on model).

# BEFORE THE FIRST USE



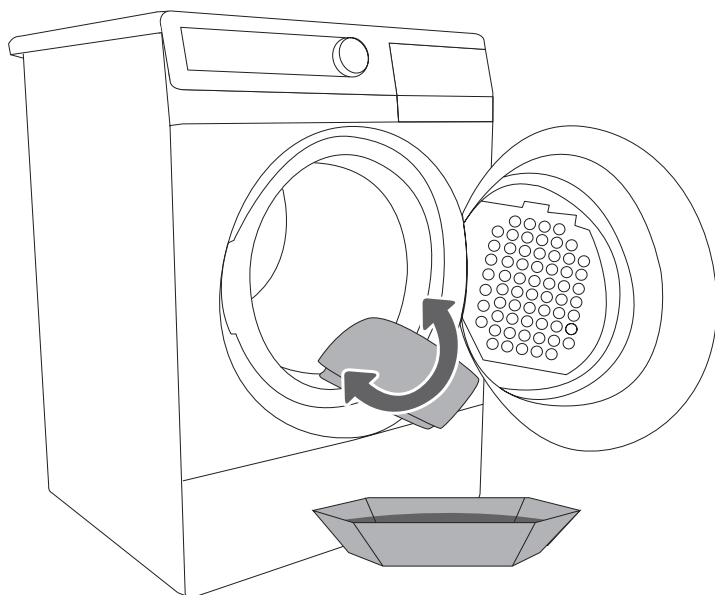
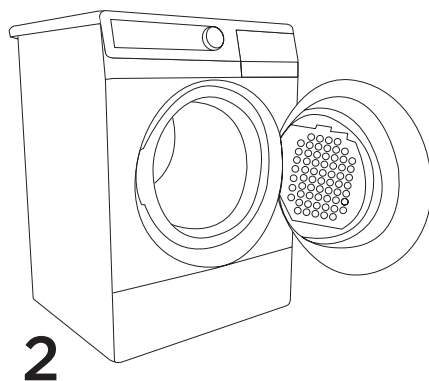
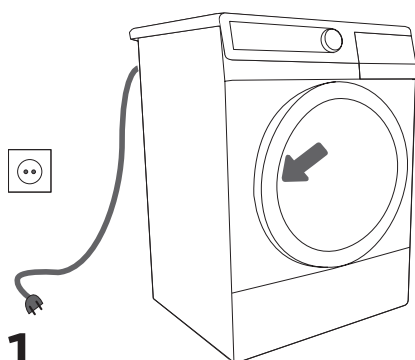























Open the disconnected dryer by pressing the door on the left side.



Clean the dryer drum before using the dryer for the first time. Use a damp cloth and a mild cleaning agent.

# DRYING STEPS (1 - 6)

## 1. STEP: CHECK THE TAGS ON YOUR LAUNDRY

<b>Normal wash</b> <b>Delicate wash</b>	Max. washing 95°C  	Max. washing 60°C  	Max. washing 40°C  	Max. washing 30°C  	Manual washing 	Washing not allowed 
<b>Whitening</b>	Whitening in cold water 			Whitening not allowed 		
<b>Dry cleaning</b>	Dry cleaning in all solvents 	Perchloret- yhylene R11, R113, Petrolej 	Dry cleaning in kerosene, in pure alcohol and in R 113 	Dry cleaning not allowed 		
<b>Ironing</b>	Hot iron max. 200°C 	Hot iron max. 150°C 	Hot iron max. 110°C 	Ironing not allowed 		
<b>Drying</b>	Place on flat surface 	Hang wet  Hang 	High temp.  Low temp. 	Tumble drying not allowed 		

## 2. STEP: PREPARING THE LAUNDRY

1. Sort the laundry by type and thickness of the fabric (see Program Table).
2. Close the buttons and zips, tie any ribbons, and turn the pockets inside out.
3. Place very sensitive clothes in a special-purpose laundry washing bag.

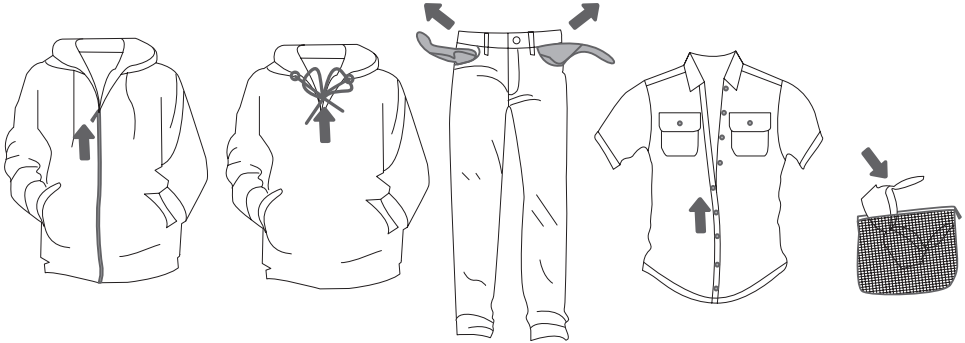

The following types of laundry may not be dried in the dryer as this may cause your garments to deform:

- leather garments and other leather products;
- garments that are waxed or treated in any other way;
- garments with major wooden, plastic, or metal parts;
- garments with spangles;
- garments with metal parts subject to rusting.

The final part of a tumble dryer cycle occurs without heat (cool down cycle) to ensure that the items are left at a temperature that ensures that the items will not be damaged.

Remove all objects from pockets such as lighters and matches.

Oil-affected items can ignite spontaneously, especially when exposed to heat sources such as in a tumble dryer. The items become warm, causing an oxidation reaction in the oil. Oxidation creates heat. If the heat cannot escape, the items can become hot enough to catch fire. Piling, stacking or storing oil-affected items can prevent heat from escaping and so create a fire hazard.

If it is unavoidable that fabrics that contain vegetable or cooking oil or have been contaminated by hair care products be placed in a tumble dryer they should first be washed in hot water with extra detergent - this will reduce, but not eliminate, the hazard.

## DRYING IN A BASKET (ONLY WITH SOME MODELS)



Prior to first drying remove the basket and any wrappings from the drum.

Drying in a basket may be selected only at time defined drying.

Mount the basket in the opposite order of the procedure for its removal, but without the transport packaging.

The basket drying function is used to dry sneakers or other things which you want to prevent from tumbling within the drum (max. load: 2,5 kg).

Dry only clean sneakers. Wring them after washing to such extent that they do not drip water prior inserting into the dryer.

During this function the basket remains still. Be careful to avoid things which are being dried to touch the drum as they may get stuck and thus damaged.

**After the drying is over, replace the filter again.**

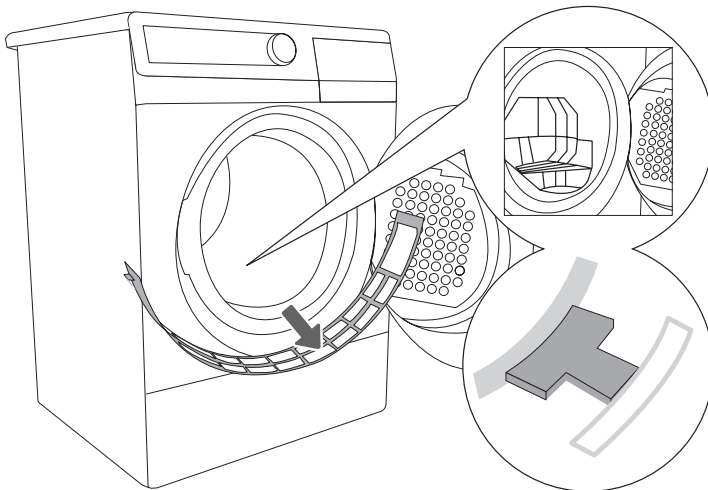

.....  
**1** Before installing the basket, it is necessary to remove the filter situated on the lower side of the door opening.

# SWITCHING ON THE DRYER

Connect the appliance to the power mains by plugging in the power cord.

To light up the drum, rotate the program selector dial to any position.

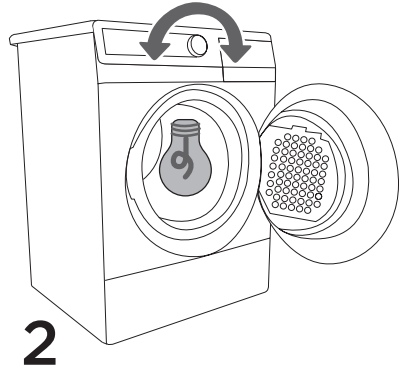
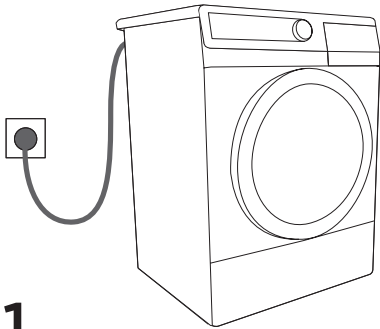

---

# LOADING THE DRYER

Open the dryer door by pressing it on the left side towards the dryer.

Insert the laundry into the drum (make sure the drum is empty).

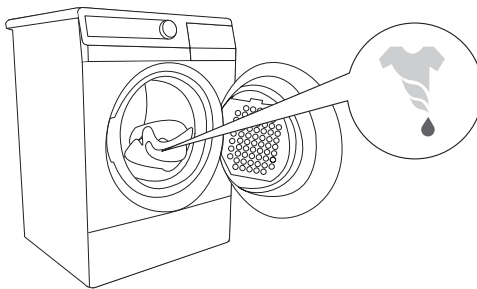

**Do not insert laundry into the dryer if it has not been wrung or spun (recommended minimum spinning cycle: 800 rpm).**

**Close the dryer door.**





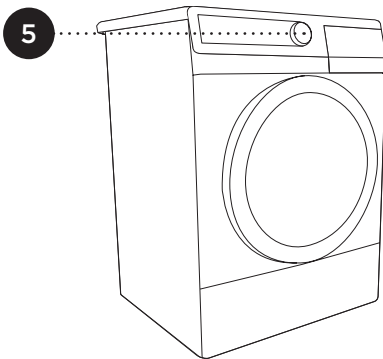
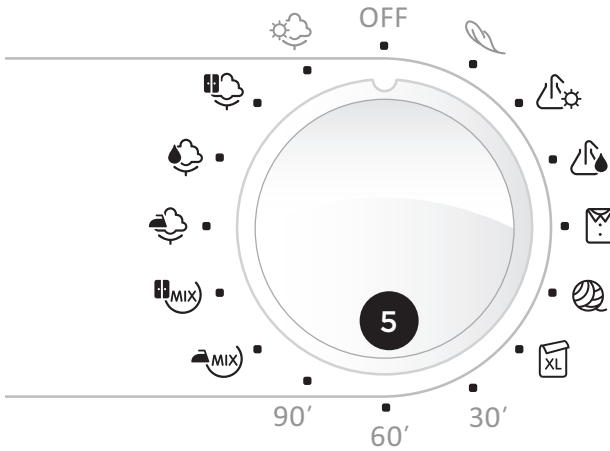







### 3. STEP: SELECTING A PROGRAM

To select a **program**, rotate the program selector dial (5) to the left or to the right (according to the type of desired level of dryness of the laundry).



During operation, the dial will not rotate automatically.

# PROGRAM TABLE

Program Dryness levels	Max. load	Laundry	Extra functions
<b>Cotton</b>  Ultra  Storage  Standard*  Iron	<b>7 kg</b> <b>D722CM</b>	Non-delicate cotton laundry (towels, terry towels, stockinette, T-shirts, trousers, kitchen cloths etc.) <b>NOTE: Cotton Ultra, Extra dry is the program used for drying a normal load at rated capacity</b>	<ul style="list-style-type: none"> <li>• Low temperature</li> <li>• Start delay</li> <li>• Extra dry</li> </ul>
<b>Mix</b>  Storage  Iron	3 kg/ 3,5 kg	Clothing made of a mixture of fibres (trousers, T-shirts, suits etc.)	<ul style="list-style-type: none"> <li>• Low temperature</li> <li>• Start delay</li> <li>• Extra dry</li> </ul>
<b>Timed program</b> Duration: 30' /60' /90'	3 kg/ 3,5 kg	Laundry that needs to be thoroughly dried, or a small amount of laundry, or individual garments.	<ul style="list-style-type: none"> <li>• Low temperature</li> <li>• Start delay</li> </ul>
 <b>Bedlinen</b>	5 kg/ 5 kg	Larger pieces of laundry (bedding, large tablecloths, large towels etc.) - prevents the laundry from forming into a bulk.	<ul style="list-style-type: none"> <li>• Low temperature</li> <li>• Start delay</li> <li>• Extra dry</li> </ul>
 <b>Wool softening</b>	2 kg/ 2 kg	Wool garments and garments with mixed fibres containing wool, which you wish to soften (sweaters, scarves, shawls etc.)	
 <b>Shirts</b>	2 kg/ 2 kg	Shirts and blouses	<ul style="list-style-type: none"> <li>• Low temperature</li> <li>• Start delay</li> <li>• Extra dry</li> </ul>
<b>Synthetics</b>  Dry  Ultra	3 kg/ 3,5 kg	Garments made of or containing with synthetic fibres (T-shirts, trousers, suits, socks and stockings, gowns etc.)	<ul style="list-style-type: none"> <li>• Low temperature</li> <li>• Start delay</li> <li>• Extra dry</li> </ul>
 <b>Sensitive</b>	2 kg/ 2 kg	Laundry that requires drying at lower temperatures (blouses, delicate underwear, shirts with additional décor etc.) - Use of special-purpose laundry washing bag is recommended.	<ul style="list-style-type: none"> <li>• Start delay</li> <li>• Extra dry</li> </ul>

## 4. STEP: ADDITIONAL FUNCTIONS (EXTRA)

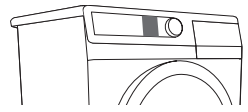

Activate/deactivate the function by pressing the relevant key (before pressing the START/PAUSE key).



### Extra dry

Each time the key is pressed (three levels), the final level of laundry dryness and drying time will change.



### Lower temperature

Used for delicates. Reduced temperature depends upon the program where this function is applied. After the program is completed the option is not memorized.



### Start delay

For delayed start of operation. Push the button to gradually change delayed start for: 2h, 4h or 12h.

Function is activated by pushing the START/PAUSE button. Countdown time is displayed by signal lamps 3a,b,c. When the countdown is completed, the drying program automatically starts.

The function is activated when the START/PAUSE key is pressed. Time is counted down by minutes. When the countdown reaches zero, the selected drying program will start automatically.

To interrupt or change the program delay time press the START/PAUSE key. Press the (4c) key to select a new delay time. To confirm the new setting, press the START/PAUSE key.

To quickly cancel the delayed start setting, press the (4c) key and hold it for 3 seconds.



## Child lock

To activate the child lock by simultaneously pressing the (4b) and (4c) keys and holding them for at least three seconds. The signal light will light up to confirm the selection.

Follow the same procedure to deactivate the child lock. As long as the child lock is activated, program or additional functions cannot be changed. The appliance can only be switched off by rotating the program selector dial to the "OFF" position. Child lock will remain activated even after the appliance is switched off. In order to select a new program, it has to be switched off.



**Some functions cannot be selected with some programs; an acoustic signal and a flashing light will remind you of such cases (see Program Table).**

## ANTICREASE EXTRA

Option for crease prevention when laundry is not extracted from the dryer immediately upon the end of drying. Default setting is 2 hours. Function stops when the door of the appliance is opened.



**When the appliance is switched off, all optional settings are reset to basic settings, except for the Child Lock.**

## STANDBY MODE

If no program is selected and started and no other action is taken within five minutes after turning on the machine, the display will be automatically turned off to save energy. Signal light on the START/PAUSE key will flash.

The display will turn on again when you rotate the program selector dial or press any button. If no action is taken after the end of the program, the display will also be turned off after five minutes. Signal light on the START/PAUSE key will flash.

$P_o$ = weighted power in 'off mode' [W]	0,02
$P_l$ = weighted power in the 'left on mode' [W]	0,5
$T_l$ = time in 'left on mode' [min]	10,0



**Drying time can change as a result of low mains voltage or different laundry loads.**

## 5. STEP: PROGRAM START-UP

Press the START/PAUSE key.

In case of selected countdown time to the end of the program, appropriate signal lamps are lit, otherwise drying stage signal lamps are lit (operation 3a, cooling 3b, end of drying 3c).

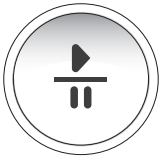

## 6. STEP: END OF DRYING CYCLE

An acoustic signal will indicate the end of the drying cycle. Signal lights will light up and the light on the START/PAUSE key will flash.

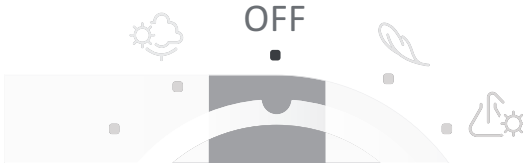

1. Open the dryer door.
2. Clean the filters (see section Cleaning ...).
3. Take the laundry from the drum.
4. Close the door!
5. Switch off the appliance (rotate the program selector dial (5) to the "OFF" position).
6. Empty the condensate tank.
7. Unplug the power cord from the outlet.



**Drying time indicated is based on tests according to the EN 61121 standard and it may change in steps during the drying process, depending on the load and initial moisture of the laundry.**

# CLEANING AND MAINTENANCE

Dryer is fitted with the filtering system containing several filters.

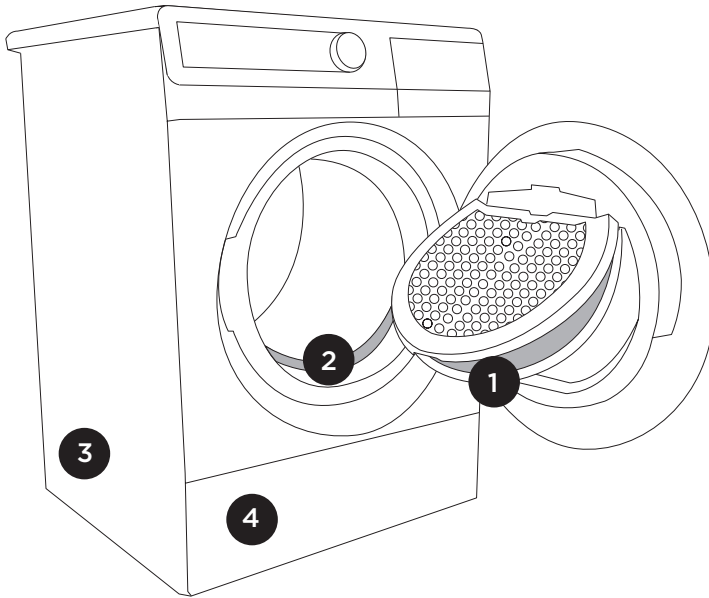

**1** Net filter

**2** Filter on the lower side of the door opening (depending on the model)

**3** Evacuation opening (depending on the model)

**4** Condenser (depending on the model)



The dryer should never be operated without the filters in place, or with damaged filters as excessive amount of accumulated fibres from the fabric could cause malfunction or failure of the dryer.

# CLEANING THE FILTER ON THE LOWER SIDE OF THE DOOR OPENING (DEPENDING ON THE MODEL)

Before emptying the drum, clean the filter on the lower door opening using your hand or a damp cloth

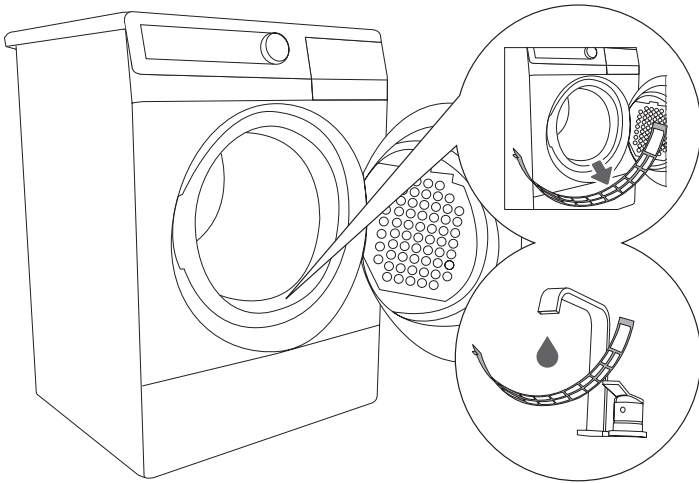

.....

**1** If the filter is clogged and requires washing, remove it from the support bed.

.....

**2** Rinse it under running water, and dry it. Make sure the filter snaps back into place before you close the filter cover.



If the filter is not cleaned regularly, airflow will be reduced which in turn prolongs the drying time; in addition, this could result in a dryer malfunction due to overheating.

After five drying cycles, clean the filter with water and dry it before replacing it.

# CLEANING THE NET FILTER IN THE DOOR

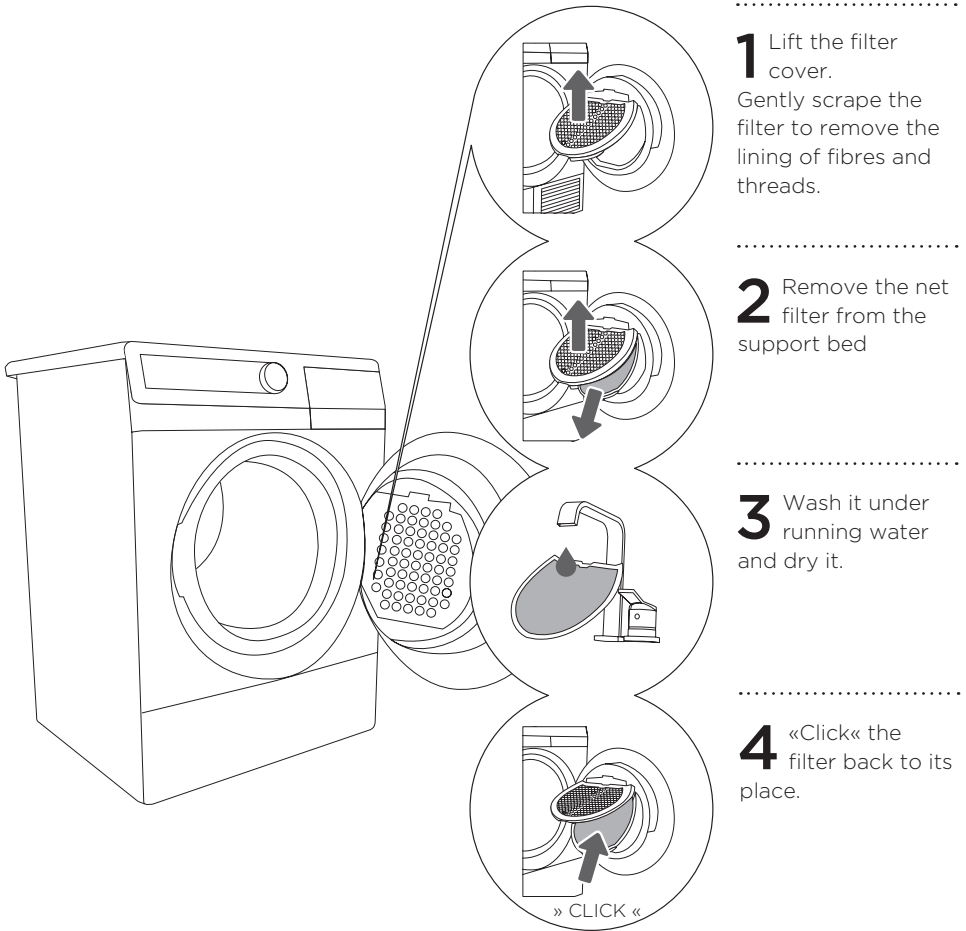

## Clean the net filter after each drying cycle.

Make sure the net filter snaps back into place before you close the filter cover. (Otherwise, the filter will not perform its function, which may result in clogging of the system.)

Close the filter cover in the door always carefully not to crush your fingers.

If necessary, clean the filter housing and door gasket as well.

# CLEANING OF WATER CONDENSER (CONDENSATION DRYER ONLY)

Certain amount of water may drip out from the condenser, so it is advisable to spread absorbent cloth on the floor prior commencement of cleaning.

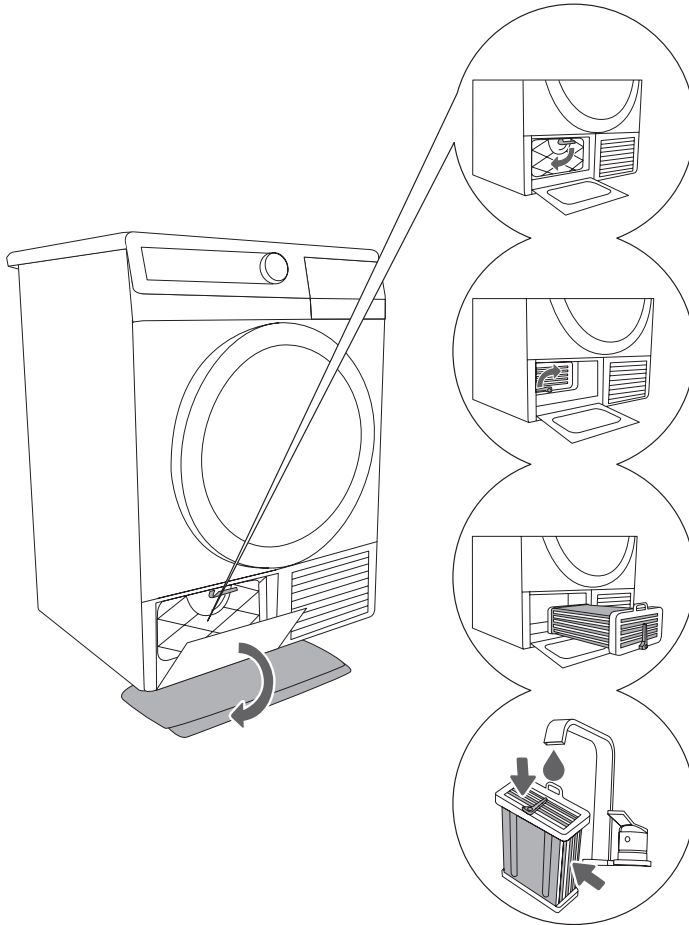

**1** Open exterior lid, grab the handle on the left and pull downwards. Remove interior lid by turning the handle downwards.

**2** Turn the condenser handle upwards.

**3** Use the handle to pull the condenser out.

**4** Rinse the interior of the condenser on both sides with lukewarm jet of water, and let dry thoroughly.

## After five drying cycles:

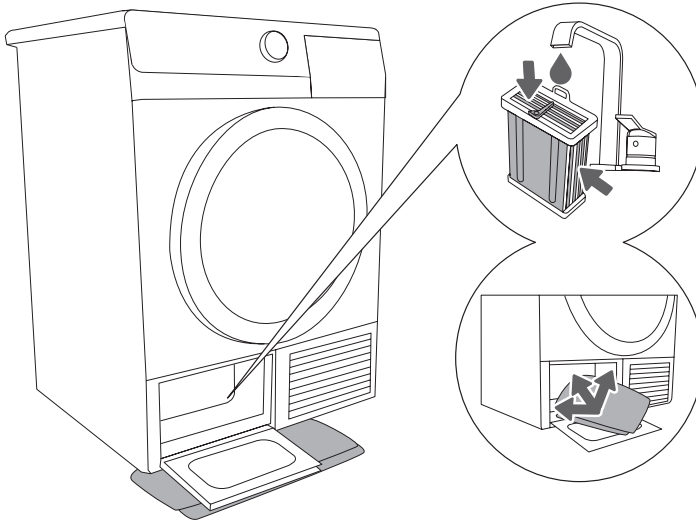

.....

**1** Extract, wash and reinstall water condenser (see »Cleaning of water condenser« on preceding page).

.....

**2** Use damp cloth to clean the water condenser cavity;

**2a** Wipe thoroughly the back of the condenser cavity (reach deeply into the cavity to be able to touch the rear wall with your hand),

**2b** use damp cloth to wipe and clean all seals and sealing surfaces of the condenser cavity and door.

.....

# EMPTYING THE CONDENSATE TANK (CONDENSATION DRYER ONLY)

Empty the condensate tank after each drying cycle.

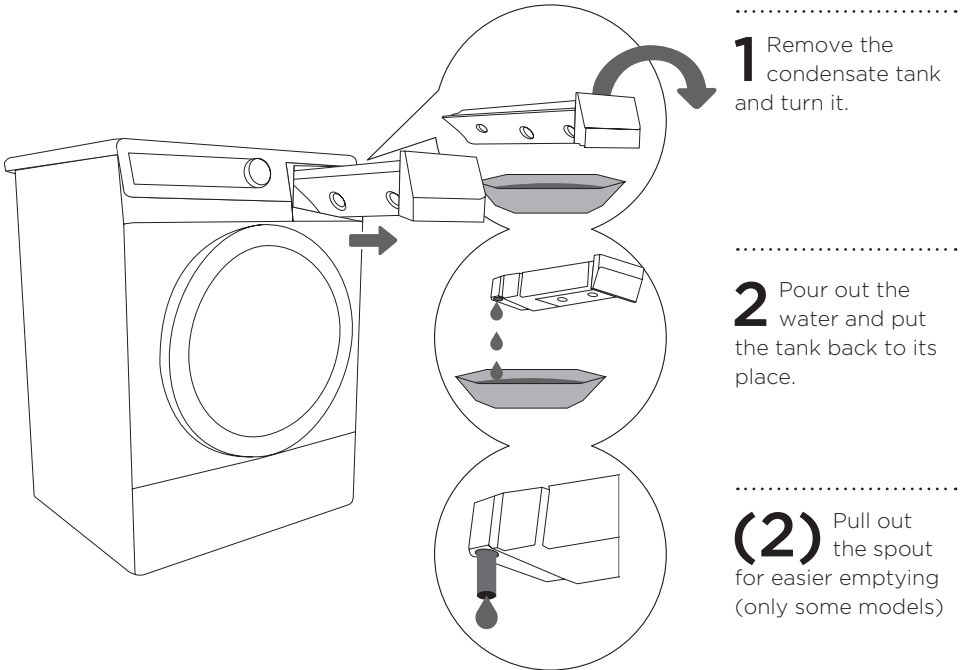

**Water from the condensate tank is not potable. If thoroughly filtered, it can be used for ironing.**

**Never add any chemical means or scents or perfumes into the condensate tank.**

**Make sure you disconnect the appliance from the power mains before cleaning. Set the program selector dial to "OFF" position and unplug the power cord from the outlet.**

## CLEANING OF EVACUATION DUCT (FOR VENTED DRYER ONLY)

The interior of the air exhaust and evacuation duct opening must be cleaned (vacuumed) periodically.

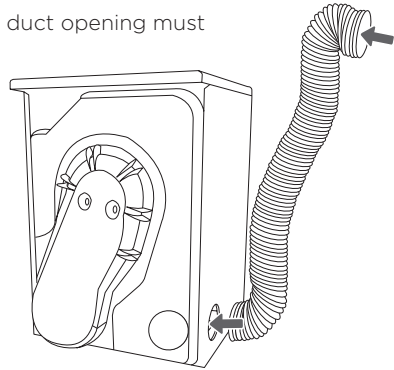

## CLEANING THE DRYER

Wipe the dryer exterior using a damp cloth and mild detergent. Do not use detergents or cleaners that could damage the dryer (heed the recommendations and warnings by the cleaner/detergent manufacturers). Use a soft cloth to wipe dry all parts of the dryer.

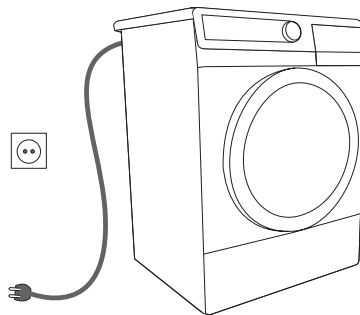

**Always disconnect the dryer from the power mains before cleaning.**

Additional equipment and facilities for maintenance can be seen on: [www.gorenje.com](http://www.gorenje.com)

# INTERRUPTING AND CHANGING THE PROGRAM

## INTERRUPTIONS

### Interrupting the program process

Press the START/PAUSE key to pause/resume and the program.

#### Open door

If the dryer door is opened during the drying process, the drying cycle will be interrupted.

When the door is closed and the START/PAUSE key is pressed, the drying will resume from the point at which it was interrupted.

#### Full condensate tank

(samo za kondenzacijski sušilni stroj)

When the condensate tank is full, the drying program will be interrupted (signal light 2b will flash).

Empty the condensate tank (see section Cleaning and Maintenance).

Press the START/PAUSE key to resume the drying cycle from the point at which it was interrupted.

#### Power supply failure

When power supply is resumed, the signal light on the START/PAUSE key will flash.

To resume the drying process, press the START/PAUSE key.

## CHANGING THE PROGRAM/FUNCTIONS

Press the START/PAUSE key and rotate the program selector dial to the "OFF" position.

Select another program/function and press the START/PAUSE key again.

## WHAT TO DO...?

Disturbances from the environment (e.g. the power grid) may result in various error reports (see Table on the next page) In such case:

- switch off the appliance and wait at least one minute;
- switch on the appliance and restart the drying program.
- If the error persists, call an authorized service unit.
- You will be able to solve most of the **problems** in dryer operation by yourself.
- **Repairs** may only be carried out by an adequately trained person.
- Repair or any warranty claim resulting from incorrect connection or use of the dryer shall not be covered by the warranty. In such cases, the costs of repair shall be charged to the user.



The warranty does not cover the errors or failures resulting from disturbances from the environment (lightning strike, power grid failures, natural disasters etc.).

Problem/error	Cause	What to do ...?
The dryer does not work.	<ul style="list-style-type: none"> <li>No voltage in the power outlet</li> </ul>	<ul style="list-style-type: none"> <li>Check if the power cord plug is correctly inserted into the power outlet.</li> <li>Check the fuse.</li> </ul>
There is voltage in the outlet, but the drum does not spin and the dryer does not work.	<ul style="list-style-type: none"> <li>Program was not started in accordance with the instructions.</li> <li>The door is not properly closed.</li> <li>Condensate tank is full (condensation dryer only).</li> <li>Delayed start function has been selected.</li> </ul>	<ul style="list-style-type: none"> <li>Reread the instructions for use again.</li> <li>Push the door towards the appliance.</li> <li>Empty the condensate tank (see section Cleaning and Maintenance).</li> <li>Wait until delayed time elapses.</li> </ul>
Laundry is not dried, or drying temperature is longer than 4h.	<ul style="list-style-type: none"> <li>Filters are not clean. The room is not sufficiently ventilated.</li> <li>Inappropriate temperature in the room.</li> <li>Laundry was not sufficiently wrung or spun.</li> <li>Amount of laundry dried in the appliance is too large or insufficient.</li> </ul>	<ul style="list-style-type: none"> <li>Clean the filters.</li> <li>Install the dryer in an appropriate room (see section Installation ...)</li> <li>Check if the temperature in the room where the dryer is installed is too high (over 25°C) or too low (below 5°C).</li> <li>Check the length of the evacuation tube - max. 2 m (only for air vented model of the dryer).</li> <li>Laundry inserted into the dryer was not sufficiently wrung or spun, or an inappropriate drying program was selected.</li> <li>Use an appropriate program or use the timed program. Increase the final level of dryness for the selected program (intensive drying function).</li> </ul>
Poor condensation (condensation dryer only)	<ul style="list-style-type: none"> <li>Inadequate location of the dryer.</li> </ul>	<ul style="list-style-type: none"> <li>Check whether the ambient temperature of the room is not too high.</li> <li>Check whether the condenser is clean.</li> </ul>
Unevenly dried laundry.	<ul style="list-style-type: none"> <li>The amount of laundry dried at a time is too large.</li> <li>Drying the pieces of different thicknesses</li> <li>Drying the different types of laundry</li> </ul>	<ul style="list-style-type: none"> <li>Make sure the laundry is sorted by type and size of items given the selected program (see section Drying - Preparing the Laundry and the Program Table).</li> </ul>
Error in the drum lighting.	<ul style="list-style-type: none"> <li>There is no lighting when the dryer door is opened.</li> </ul>	<ul style="list-style-type: none"> <li>Disconnect the dryer from the power mains and call an authorized service unit.</li> </ul>

When all lamps are blinking switch the appliance off and call nearest authorized service shop (assistance center).

# TIPS AND RECOMMENDATIONS FOR DRYING AND ECONOMIC USE OF YOUR DRYER

The most economical way of drying is to dry the recommended amount of laundry in each batch (see Program Table).

Drying laundry made of particularly delicate fabrics that may be deformed is not recommended.

Use of conditioner in the washing cycle is not necessary as the laundry is soft and smooth after drying in the dryer. Drying time will be shorter and power consumption will be lower if the garments are thoroughly wrung or spun before drying. By selecting the appropriate drying program, you will avoid overdrying your laundry and problems with ironing or shrinkage of fabric.

Regular cleaning of the filters will lead to optimum drying time and minimum power consumption.

When drying smaller amounts of laundry or individual garments, the sensor may not perceive the actual level of moisture in the laundry. In such cases, it is recommended to dry smaller items or amounts with programs for dryer laundry or with the timed program.

# DISPOSAL

**Packaging** is made of environmentally friendly materials that can be recycled, disposed of, or destroyed without any hazard to the environment. To this end, packaging materials are labelled appropriately.



The **symbol** on the product or its packaging indicates that the product should not be treated as normal household waste. The product should be taken to an authorized collection center for waste electric and electronic equipment processing.

When **disposing** of an obsolete appliance, make sure you remove the power cord and destroy the door switch and latch to prevent the door from closing (children safety).

**Disposing** the product in the correct manner will help prevent any negative consequences and effects on the environment and human health which could occur in case of inappropriate product disposal. For detailed information on disposal and processing of the product, contact your relevant municipal authorities in charge of waste management, waste management service, or the store at which you bought the product.

*We reserve the right to any changes and errors in the instructions for use.*