

Proudly distributed by
De'Longhi Australia Pty Limited
P.O. BOX 4540
CASULA MALL NSW 2170
Customer Service Ph: 1800 126 659
Fax: 1800 706932
www.delonghi.com.au
e-mail: delonghi@delonghi.com.au

De'Longhi New Zealand Limited
25 Carbine Road
Mt Wellington
Auckland, New Zealand
P.O. Box 58-056 Botany
MANUKAU 2163
Customer Service Ph: 0508 200 300
Fax: 0508 200 301
www.delonghi.com.nz
e-mail: delonghi@delonghi.com.nz

KBI Series

KETTLE

Instructions for use



De'Longhi

DESCRIPTION OF APPLIANCE

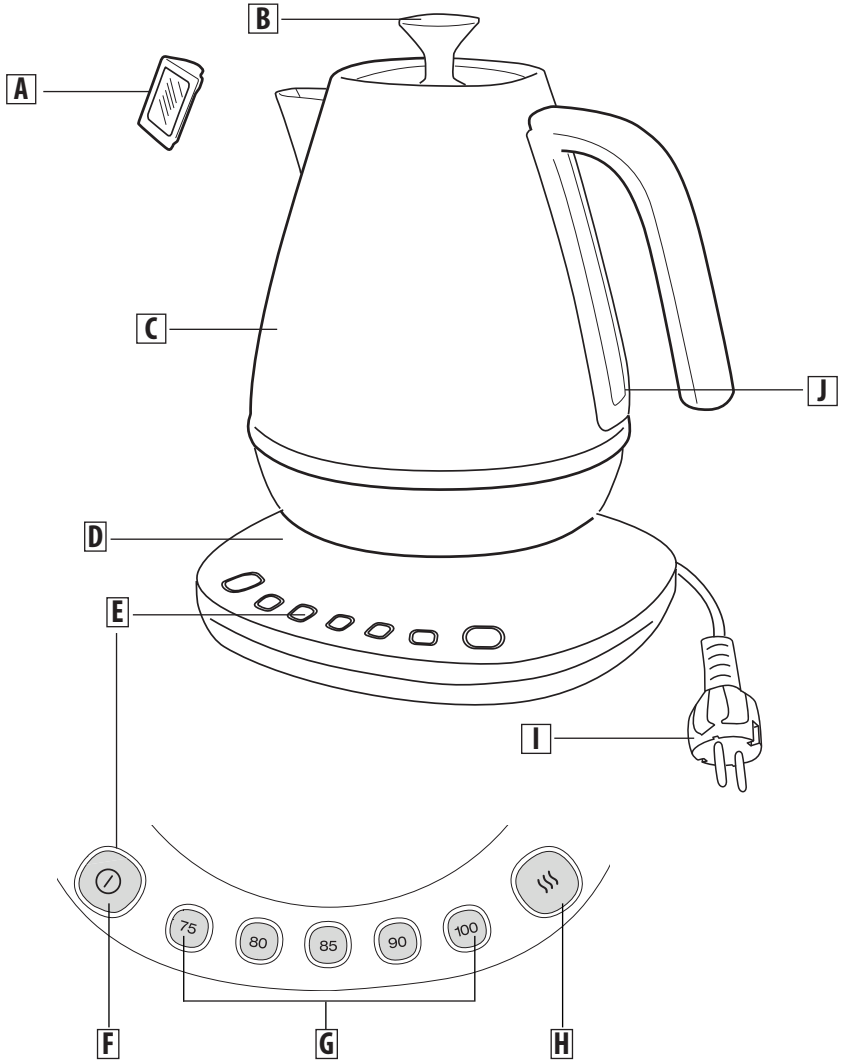

IMPORTANT WARNINGS

Safety warnings

- Avoid spillage on the connector.
- The appliance is exclusively for the use of boiling water. Any other use is to be considered inappropriate and therefore dangerous. The manufacturer cannot be held responsible for eventual damage caused by inappropriate, improper or irresponsible use and/or for repairs made to the product by unauthorised personnel.
- The appliance is designed and produced for domestic use only. It is not suitable for use in: staff kitchens in shops, offices and other workplaces, farm houses, hotels, motels or other holiday accommodation, guest houses.
- This appliance can be used by children aged 8 upwards and by persons with reduced physical, sensory or mental capabilities or who lack of experience and knowledge if they are supervised or have been given instructions concerning use of the appliance in a safe way and understand the hazards involved. Children must not play with the appliance. Cleaning and user maintenance must not be carried out by children unless they are older than 8 and supervised. Keep the appliance and its cord out of the reach of children under 8 years of age.
- Do not remove the lid while the kettle is boiling.
- The power cable must not be replaced by the user as this requires the use of special tools.
If the supply cord is damaged, it must be replaced by the manufacturer, its service agent or similarly qualified persons in order to avoid a hazard.

- If the kettle is overfilled, boiling water may overflow.
- The heating element surface is subject to residual heat after use.
- Use the kettle only with the power base supplied (and vice versa).



Danger!

Failure to observe the warning may result in life threatening injury by electric shock.

- To protect against electrical hazards do not immerse the mains lead, plug power base or kettle in water or any other liquid. Do not use in the bathroom or near any source of water. Do not use outdoors.
- Remove the plug from the mains socket when not in use and before cleaning. Allow the kettle to cool before cleaning.
- Do not use the kettle if you have wet hands.
- Do not place any utensils into the kettle.
The use of accessory attachments not recommended by the appliance manufacturer may result in fire, electric shock or personal injury.



Important!

Failure to observe the warning could result in injury or damage to the appliance.

- Take care when pouring - do not over-tilt the kettle as water may enter into the switch mechanism.
- Close supervision is necessary when any appliance is used near children.
- Do not operate the kettle on an inclined surface.
- Do not operate this kettle if the mains lead or plug is damaged, if the kettle malfunctions, or has been damaged in any manner. It must be returned to an authorised service agent for repair or replacement in order to avoid hazard.



Danger of burns!!

Failure to observe the warning could result in burns or scalds.

- Do not touch hot surfaces i.e. body or lid. Use handles or knobs.
- Water can remain hot for a long time after boiling and can present a scald hazard. Keep the kettle and the mains lead away from the edge of the work surface and out of the reach of children.
- Do not allow the mains lead to hang over the edge of the table or work surface.
- Avoid contact with steam coming out of the spout when pouring, and out of the lid or spout when refilling.

- Keep the kettle, the power base, and the mains lead away from hotplates, hobs or burners.



Please note:

This symbol indicates recommendations and important information for the user.

- Remove the kettle from its power base before filling.
- Never move the kettle while it is in use.
- Do not use the kettle for any purpose other than heating water.
- De'Longhi will not accept any liability if the appliance is subject to improper use, or failure to comply with these instructions.
- Never use the kettle without its lid and filter.
- Position the kettle properly on the power base before switching on.

CE The appliance complies with the following EC directives:

- This appliance conforms to the Directive 2004/108/EC relative to electromagnetic compatibility.
- Materials and accessories coming into contact with food conform to EC regulation 1935/2004.

Disposing of the appliance



In compliance with European directive 2002/96/EC, the appliance must not be disposed of with household waste, but taken to an authorised waste separation and recycling centre.

INTRODUCTION

Thank you for choosing a De'Longhi product. Please take a few moments to read the instructions to avoid risks or damage to the appliance.

DESCRIPTION

- A** Removable filter
- B** Removable lid
- C** Kettle body
- D** 360° electric base with cable tidy
- E** Buttons
- F** START/STOP
- G** Temperature selection
- H** Keep warm function
- I** Plug
- J** Water level indicator

USE

Before use

- Remove all packaging from the kettle and power base.

- Remove any labels from the outer stainless steel surfaces.
- Remove the filter (fig. 1) and wash with water (fig. 2). Refer to "Removing the scale filter".

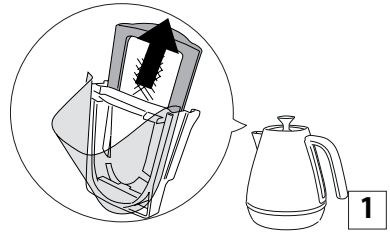

- Fill the kettle and boil.
- The boiled water should be discarded and the kettle rinsed out with cold water. This procedure should be carried out three times, to remove any manufacturing dust, etc.
- After the kettle has been rinsed out, re-fit the filter (fig. 3).

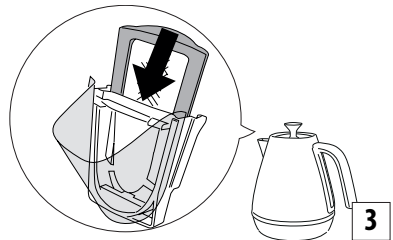

In use

With the specially designed power base and central connector, you can now set the kettle on the base at any angle, from any position.

- Release cord from storage base and adjust length by winding around the base to give the correct cord length to reach the plug socket to be used (fig. 4).
- Do not leave loose cord hanging over the edge of work surfaces.

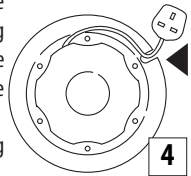

Filling



- Remove the kettle from the base unit before filling.
- Open lid and fill kettle to desired level.

Do not fill with less than 0,3 litre of water to prevent the kettle running dry while operating; misuse of this kind will shorten the life of the element.

Do not fill with more than 1.7 litres of water (up to the MAX level).

If the kettle is overfilled, there is a risk that boiling water may be ejected causing burns.

Switching on and operation

- Plug into the mains. All of the buttons will light up for a few seconds and a beep will sound.
- Set the kettle on the electric base.
- Press the button  to turn the kettle on.
- The appliance lets you select from the following temperatures: 75°C, 80°C, 85°C, 90°C, 100°C in order to choose the most suitable one see “Recommended temperatures table”.
- Select the desired temperature by pressing 75, 80, 85, 90 or 100. The button selected will light up and the kettle will start operating. The button for the temperature selected will start to flash slowly.
- The set temperature can be changed during operation (A lower temperature cannot be chosen if the water temperature is higher than the one selected).
- The kettle shuts off automatically and beeps 3 times when the water has reached the desired temperature. The temperature button selected will stay on.
- Kettle operation can be shut off or interrupted at any time by pressing the on button  or removing the kettle from the base.



 **Please note:** if the kettle is lifted before the selected temperature has been reached, once it is put back on the base it will restart automatically. The last selection made will remain in the memory for about 5 minutes.

RECOMMENDED TEMPERATURES TABLE



Temperature setting	Recommended for
75°C	Green tea
80°C	Jasmine tea
85°C	Oolong tea
90°C	Instant coffee
100°C	Instant beverages that call for boiling water

 **Please note:** for a more accurate temperature adjustment, we recommend filling the kettle with at least 1 litre of water (4 cups).

KEEP WARM FUNCTION

- Press the button  once and select the temperature from 75°C and 90°C. Press the keep warm button  (the button  will light up). The kettle will start operating.

 **Please note:** the keep warm function cannot be activated if 100°C is selected.

- As soon as the water has reached the desired temperature, the Keep Warm function will automatically activate to keep the water at the desired temperature. The button  remains lit during the keep warm period (about 20 minutes) and shuts off automatically.
- To interrupt this function at any time, just press the button  once and the light will shut off. The kettle will continue to operate without the Keep Warm function.

Pouring

- Remove the kettle from the power base and carefully pour out the water. Do not tilt the kettle suddenly or pour water out at too sharp an angle.
- When you lift the kettle from the base, you may see moisture on the top surface of the base. Condensation on the base is perfectly normal, and should not be a cause for alarm.

MAINTENANCE

Cleaning the kettle

- Allow the kettle to cool down fully and disconnect the appliance from the mains before cleaning.
- Do not immerse the kettle or base in water.
- Use a soft dampened cloth to wipe the outside of the kettle and dry with a soft, dry cloth.
- DO NOT use metal polish or harsh scouring agents.
- Ensure that all connectors and sockets are kept dry.

 **Important!** Avoid accidentally spilling water on the buttons. If this occurs, unplug the base from the mains and thoroughly dry the buttons before switching the kettle back on.

Scale

Scale is mainly calcium carbonate (chalk), a harmless, naturally occurring mineral found in most water supplies. “Hard” water contains more of this mineral than “soft” water. When the water is heated, the minerals in the water solidify, making the water

appear cloudy. These minerals form a thin film on the walls, element and on the surface of the water. The water may look like it has white coloured pieces of plastic floating on the surface. On traditional kettle elements, scale forms a hard white “crust” which adversely affects performance and reduces the life of the element.

As soon as you notice a film forming on the water, or, when cleaning the filter, if you notice a film on the walls or the element, simply rinse the kettle and wipe it out.

Scale filter

Your kettle is fitted with a scale filter to prevent loose particles of scale being poured into your beverage. This filter is both removable and washable. The frequency with which you will need to clean any scale deposits from your filter will depend on the hardness of water in your area and how often you use the kettle. You should remove and clean the water filter when you notice any deposits being left on the filter or if the pouring efficiency is impaired.

Removing the scale filter

- Allow the kettle to cool down fully.
- Disconnect the appliance from the mains electrical supply.
- Make sure that your hands are clean and free from soap, cream or anything which might taint the water.

- Empty the kettle and remove the filter as shown in fig. 1.
- Rinse under a tap whilst brushing with a soft brush (fig. 2).
- Replace the filter (fig. 3).

To clean the scale filter

It is vital to clean and descale regularly in order to maintain good working order.

- Use descaler for kettles. When limescale starts forming on the heating element, buy a suitable descaler and descale according to the instructions given on the descaler pack. After descaling, boil the kettle repeatedly with fresh water and rinse thoroughly to completely eliminate all residues of descaler which could damage the appliance. If the filter requires descaling, remove and immerse in the same descaling solution.
- Make sure electric parts are completely dry before using the kettle.

TROUBLESHOOTING

Problem	Cause	Solution
The kettle does not function	No power The kettle is not plugged in	Make sure the kettle is plugged in Make sure the kettle is correctly positioned on the base
The Keep Warm function doesn't activate	Temperature selected: 100°C	The Keep Warm function cannot be activated if the temperature selected is 100°C, even if the button is lit
Long shut off times or the kettle shuts off too early	Scale/mineral accumulation inside the kettle	See paragraph “To clean the scale filter”
The kettle turns on and off during operation	The kettle is adjusting the water temperature	This is a perfectly normal situation
The appliance beeps 8 times and all of the buttons flash	The temperature sensor is damaged	Contact the service agent
When pressing one of the temperature buttons the kettle does not activate or beeps once	The temperature of the water in the kettle is greater than the temperature selected	Select a higher temperature