

---

Built-in Warming Drawer

---

User manual

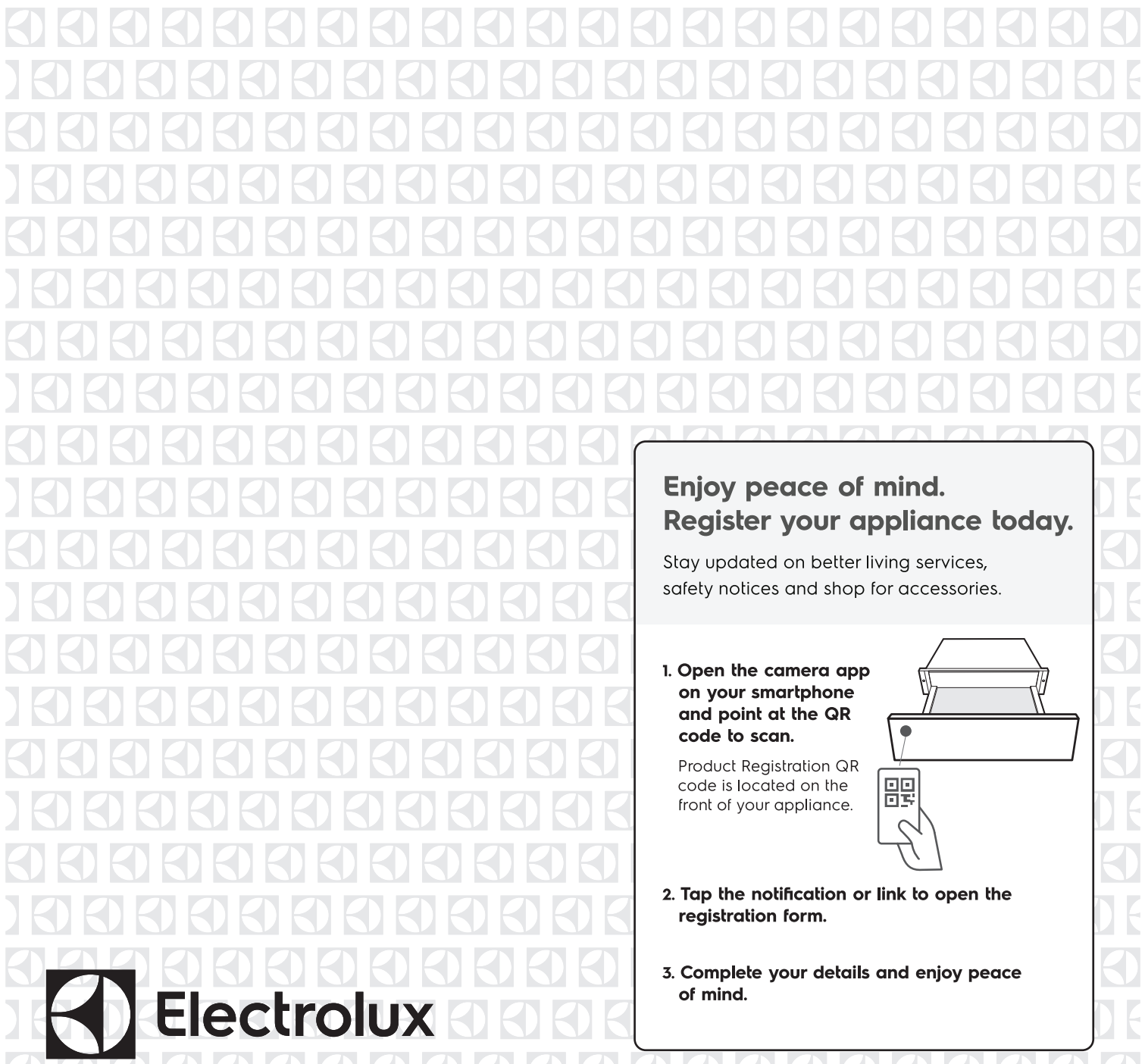

**Enjoy peace of mind.  
Register your appliance today.**

Stay updated on better living services,  
safety notices and shop for accessories.

- 1. Open the camera app on your smartphone and point at the QR code to scan.**

Product Registration QR code is located on the front of your appliance.

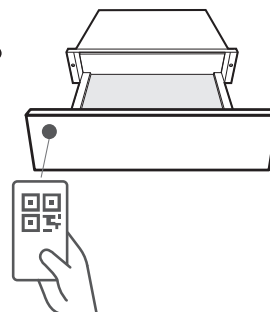

- 2. Tap the notification or link to open the registration form.**
- 3. Complete your details and enjoy peace of mind.**

## CONGRATULATIONS

Dear customer,

Thank you for purchasing an Electrolux Warming Drawer. You've chosen a product that brings with it decades of professional experience and innovation. Ingenious and stylish, it has been designed with you in mind. So whenever you use it, you can be safe in the knowledge that you'll get great results every time.

Welcome to Electrolux.

## BEFORE USING YOUR APPLIANCE

Check for any damage or marks. If you find the appliance damaged or marked you must report it within 7 days to claim for damages under the manufacturers warranty.

Before you use the appliance, we recommend that you read through the whole user manual which provides the description of the product and its functions. To avoid the risks that are always present when you use a gas appliance, it is important that the product is installed correctly and that you read the safety instructions carefully to avoid misuse and hazards.

For future reference, please store this booklet in a safe place.

This appliance complies with the requirements of Australian Standard AS/NZS 60335.2.6.

## BEFORE YOU CALL

Please ensure you read the instruction manual fully before you call for service, or a full service fee could be applicable.

## CONDITIONS OF USE

This appliance is intended to be used in household and similar applications such as:

- Staff kitchen areas in shops, offices and other working environments
- By clients in hotels, motels and other residential type environments
- Bed and breakfast type environments
- Small catering and small non-retail applications

**Record model and serial number here:**

Model number: \_\_\_\_\_

Serial number: \_\_\_\_\_

## CONTENTS

<b>Important instructions</b> _____	<b>2</b>
Caring for the environment _____	2
Cleaning and heating up for the first time _____	2
Safety instructions _____	2
<b>Cleaning and care</b> _____	<b>4</b>
<b>Guide to the appliance</b> _____	<b>5</b>
Components _____	5
Control panel _____	5
<b>Operation</b> _____	<b>6</b>
Function settings _____	6
Temperature settings _____	6
Capacity _____	6
<b>Installation</b> _____	<b>7</b>
Safety _____	7
Environmental protection _____	7
Technical data _____	7
Building-in dimensions _____	8
<b>Troubleshooting</b> _____	<b>9</b>
<b>Warranty information</b> _____	<b>10</b>

## SYMBOLS

The symbols you will see in this booklet have these meanings:



### WARNING

**This symbol indicates information concerning your personal safety.**



### CAUTION

**This symbol indicates information on how to avoid damaging the cooker or cabinet.**



### IMPORTANT

**This symbol indicates tips and information about use of the cooker.**



### ENVIRONMENT

**This symbol indicates tips and information about economical and ecological use of the cooker.**

**NOTE:** Model codes shown in this manual are the generic code. Your product will also include a two letter suffix which denotes colour and series level.

# IMPORTANT INSTRUCTIONS

## Important Information that may impact your Manufacturer's Warranty

Adherence to the directions for use in this manual is extremely important for health and safety. Failure to strictly adhere to the requirements in this manual may result in personal injury, property damage and affect your ability to make a claim under the Electrolux manufacturer's warranty provided with your product. Products must be used, installed and operated in accordance with this manual. You may not be able to claim on the Electrolux manufacturer's warranty in the event that your product fault is due to failure to adhere to this manual.

## CARING FOR THE ENVIRONMENT



### DISPOSAL OF THE PACKING MATERIAL

The transport and protective packing has been selected from materials that are environmentally friendly for disposal, and should be recycled.



Ensure that any plastic wrappings, bags, etc are disposed of safely and kept out of the reach of babies and young children to prevent danger of suffocation.



### Disposal of your old appliance

Electrical and electronic appliances often contain materials which, if handled or disposed of incorrectly, could be potentially hazardous to human health and the environment. They are, however, essential for the correct functioning of your appliance.

Please do not dispose of old appliances with your household waste. Please dispose of them at your local community waste collection/recycling centre or contact your dealer for advice. Please ensure that it presents no danger to children while being stored for disposal.

## CLEANING AND HEATING UP FOR THE FIRST TIME

- 1 Remove any protective film and sticky labels.
- 2 Remove the anti-slip mat and sponge with warm water and a little washing-up liquid. Dry using a soft cloth.
- 3 Wipe the appliance inside and out with a damp cloth only, and then dry with a soft cloth.
- 4 Replace the anti-slip mat in the drawer.
- 5 Heat the empty drawer for at least two hours, using the following procedure:
  - Switch the appliance on by touching the  sensor.
  - Touch the  sensor repeatedly until the LED light comes on.

- Touch the  sensor repeatedly until the LED on the far right lights up
- Touch the  sensor repeatedly until 2h lights up

6 Close the drawer



### IMPORTANT

**The warming drawer is fitted with a softclose self-closing mechanism. It also has a contact switch, which ensures that the heating element and fan in the appliance only work when the drawer is closed.**



### IMPORTANT

**Metal components have a protective coating which may give off a slight smell when heated up for the first time. The smell and any vapours will dissipate after a short time, and do not indicate a faulty connection or appliance. Ensure that the kitchen is well ventilated whilst the appliance is first heated.**

## SAFETY INSTRUCTIONS



### WARNING

**These warnings have been provided in the interest of safety. You MUST read them carefully before installing or using the appliance.**

### Correct application

- The appliance is not designed for commercial use. It is intended for domestic use only in residential environments.
- The appliance is not intended for outdoor use.
- Any other usage is not supported by Electrolux and could be dangerous.
- This appliance is not intended for use by persons (including children) with reduced physical, sensory or mental capabilities, or lack of experience and knowledge, unless they have been given supervision or instruction concerning use of the appliance by a person responsible for their safety. Children should be supervised to ensure that they do not play with the appliance.
- This appliance is not a toy! To avoid the risk of injury, do not let children play with the appliance or its controls.
- The appliance gets hot when in use and remains hot for quite a while after being switched off. Keep children well away from the appliance until it has cooled down and there is no danger of burning.

# IMPORTANT INSTRUCTIONS (CONTINUED)

- Packaging, eg. cling film, polystyrene and plastic wrappings must be kept out of the reach of babies and children to avoid danger of suffocation. Dispose of or recycle all packaging safely as soon as possible.

## Correct use

The warming drawer is designed to keep hot food warm. It is not designed to warm food up from room or fridge temperature. Ensure food is already really hot when you place it in the drawer.

- You could burn yourself on the hot drawer or crockery. Protect your hands with heat-resistant pot holders or gloves when using the appliance. Do not let them get wet or damp, as this causes heat to transfer through the material more quickly, with the risk of scalding or burning yourself.
- Do not store any plastic containers or flammable objects in the warming drawer. They could melt or catch fire when the appliance is switched on.
- Due to the high temperatures radiated, objects left near the appliance when it is in use could catch fire. Do not use the appliance to heat up the room.
- Never replace the anti-slip mat supplied with the appliance with paper kitchen towel or similar.
- If you overload the drawer, or sit or lean on it, the telescopic runners will be damaged. The telescopic runners can support a maximum load of 25kg.
- Do not install this appliance behind a cupboard door, it requires adequate ventilation to operate safely.
- Do not heat up unopened tins or jars of food in the drawer, as pressure will build up in the tin or jar causing it to explode. This could result in injury or scalding, as well as potential damage to the appliance.
- The underside of the drawer gets hot when switched on. Be careful not to touch it when the drawer is open.
- Do not use plastic or aluminium containers. These melt at high temperatures and could catch fire. Use only heat-resistant crockery made of glass, porcelain, etc.
- Take care when opening and closing the loaded drawer, so that liquids do not spill over and get through the vents. This can cause the appliance to short circuit.
- Bacteria can develop on the food if the temperature is too low. Make sure you set a high enough temperature to keep food warm.

## Technical safety



### ELECTRICAL CONNECTION

The appliance is fitted with a plug and must only be connected to a properly installed earthed socket. Only a qualified electrician who takes the appropriate regulations into account may install the socket or replace the connecting cable. If the plug is no longer accessible following installation, an all-pole isolating switch must be present on the installation side with a contact gap of at least 3mm. Contact protection must be ensured by the installation.

- Installation, maintenance and repair work may only be carried out by a suitably qualified and competent person in strict accordance with national and local safety regulations. Installation, maintenance and repairs by unqualified persons could be dangerous.
- A damaged appliance can be dangerous. Before installation check the appliance for visible signs of damage. Do not use a damaged appliance.
- The electrical safety of this appliance can only be guaranteed when correctly installed and earthed. It is most important that this basic safety requirement is observed.
- To avoid the risk of damage to the appliance, make sure that the connection data (frequency and voltage) on the data plate corresponds to the household supply before connecting the appliance to mains supply. Consult a qualified electrician if in any doubt.
- Do not connect the appliance to the mains electricity supply by a multi-socket adapter or an extension lead. These do not guarantee the required safety of the appliance (eg. danger of overheating).
- For safety reasons, this appliance may only be used when it has been built in.
- Do not open the casing of the appliance. Tampering with electrical connections or components and mechanical parts is highly dangerous to the user and can cause operational faults. Warranty will also be voided.
- While the appliance is under guarantee, repairs should only be undertaken by a qualified service technician. Otherwise, warranty is voided.
- Faulty components must only be replaced by genuine Electrolux original spare parts.

- The appliance must be disconnected from the mains electricity supply during installation, maintenance and repair work. Ensure that power is not supplied to the appliance until after it has been installed or until any maintenance or repair work has been carried out.
- In areas that may be subject to infestation by cockroaches or other vermin, pay particular attention to keeping the appliance and its surroundings in a clean condition at all times. Any damage that may be caused by cockroaches or other vermin will not be covered by the warranty.
- If the power supply cord is damaged, it must be replaced by Electrolux, its service agent or similarly qualified persons in order to avoid creating an electrical hazard.

### **IMPORTANT**

The power cord can only be routed through the hole in the bottom of the drawer to avoid touching the back shell of the appliance.

### **CAUTION**

In order to avoid a hazard due to inadvertent resetting of the thermal cut-out, this appliance must not be supplied through an external switching device, such as a timer, or connected to a circuit that is regularly switched on and off by the utility.

## CLEANING AND CARE

### **DANGER OF INJURY.**

**Do not use a steam cleaning appliance to clean this appliance. The steam could reach electrical components and cause a short circuit.**

**Do not immerse the appliance in water or other liquid when cleaning.**

### **DANGER OF DAMAGE.**

**Unsuitable cleaning agents can damage the surfaces of the appliance. Only use domestic washing-up liquid to clean the appliance.**

To avoid damaging the surfaces of your appliance, do not use:

- cleaning agents containing soda, ammonia, acids or chlorides
- cleaning agents containing descaling agents
- abrasive cleaning agents, eg. powder cleaners and cream cleaners
- solvent-based cleaning agents
- stainless steel cleaning agents
- dishwasher cleaner
- oven sprays
- glass cleaning agents
- hard, abrasive sponges and brushes, eg. pot scourers
- sharp metal scrapers

Clean and dry the entire appliance after each use. Allow the appliance to cool down to a safe temperature before cleaning.

### **Appliance front and interior cleaning**

Remove any soiling immediately. If this is not done, it might become difficult or impossible to remove and could cause the surfaces to alter or discolour.

Clean all surfaces with a clean sponge and a solution of hot water and washing-up liquid. Then dry with a soft cloth. A clean, damp microfibre E-cloth without cleaning agent can also be used.

All surfaces are susceptible to scratching. Scratches on glass surfaces could even cause a breakage. Contact with unsuitable cleaning agents can alter or discolour the surfaces.

### **Anti-slip mat**

Remove the anti-slip mat from the drawer before cleaning it.

Clean the anti-slip mat by hand only, using a solution of hot water and a little washing-up liquid, and then dry with a cloth.

Do not put the anti-slip mat back into the drawer until it is completely dry.

**NOTE:** Do not wash the anti-slip mat in a dishwasher. Never place the anti-slip mat in the oven to dry.

# GUIDE TO THE APPLIANCE

## COMPONENTS

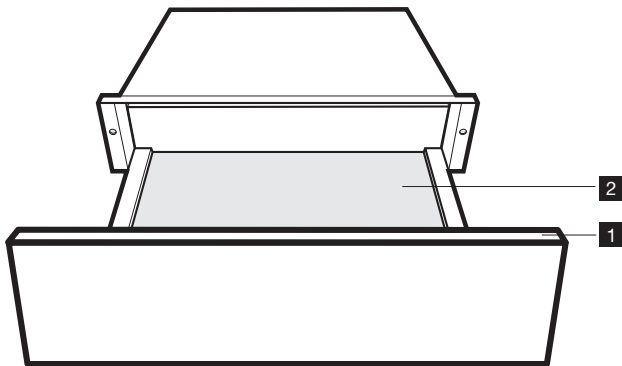

- 1** Control panel
- 2** Anti-slip mat  
(for keeping crockery secure)

Press the middle of the drawer firmly to open or close it. When opening, the drawer pops out slightly. You can then pull it out towards you.

## CONTROL PANEL

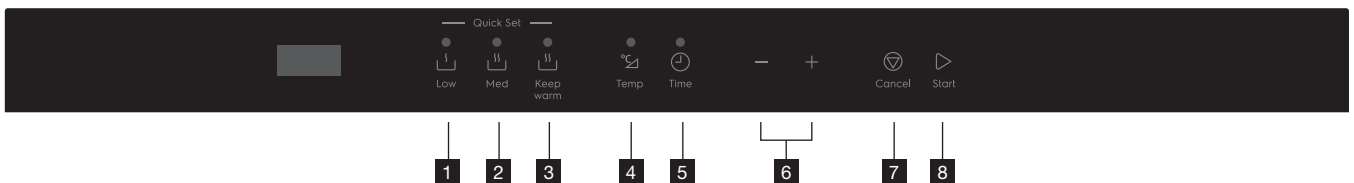







- 1** For warming cups and glasses
- 2** For warming plates and dishes
- 3** For keeping food warm
- 4** For setting the temperature
- 5** For setting the duration
- 6** For adjusting temperature and time
- 7** Cancel button
- 8** Start button











The appliance can be used to keep food warm at the same time as warming plates and dishes, but please ensure food is covered properly to prevent spillage.

# OPERATION

## FUNCTION SETTINGS

- 1 In waiting state, press  to start the function of warming cups and glasses to 40°C.
- 2 40°C will display.
- 3 Touch  or  to adjust the temperature.
- 4 Touch  and then touch  or  to adjust the warming time.
- 5 Touch  to set the temperature and time.
- 6 Close the door, there will be a beep, and then the appliance will start working.

### NOTE:

- During parameters setting, you can press other function keys to change the function between  (Low),  (Med) and  (Keep Warm).
- Before closing the door, you can touch  to cancel the setting and the appliance will go back to waiting state.
- During the process of working, open the door to enter the parameter adjusting mode, then press  or  to adjust the temperature.
- You can press either  or  to select which parameter you need to adjust, then press  to set the temperature or time.
- After saving the setting as above, you can press  to enter the waiting state, or close the door to start working.

The appliance will beep to give user feedback when buttons are touched. The appliance will automatically switch off after 1 hour if the Duration Timer has not been set.



### Duration Timer

The timer default duration is 1 hour. Longer durations can be set by touching the  sensor. One touch for 1 hour (1h), two touches for 2 hours (2h), etc., to a maximum of 5 hours.

The appliance will beep 3 times when the duration timer is finished.

## TEMPERATURE SETTINGS

Each function has its own temperature range. The factory-set recommended temperatures are printed in bold. The temperature can be altered in 5° steps by touching the  sensor. The last temperature selected is automatically activated the next time the drawer is switched on, and this is shown in the display.

	 Low	 Med	 Keep Warm
<b>Min.</b>	<b>40°C</b>	<b>60°C</b>	<b>60°C</b>
<b>Max.</b>	60°C	80°C	80°C

## CAPACITY

The quantity that can be loaded will depend to a great extent on the size and weight of your own crockery. Do not overload the drawer. The maximum load bearing capacity of the drawer is 25 kg. Under the maximum load bearing capacity, the drawer should be opened or closed carefully.

Here are some suggested examples of loading capacities:

- 6 dinner plates Ø 26cm
- 6 soup plates Ø 23cm
- 6 dessert dishes Ø 19cm
- 1 oval platter Ø 32cm
- 1 medium serving bowl Ø 16cm
- 1 small serving bowl Ø 13cm

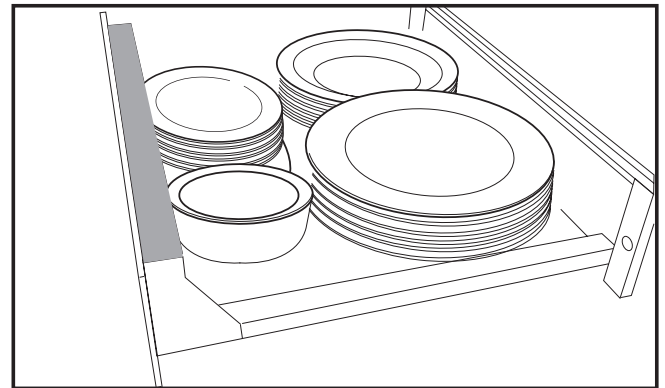

# INSTALLATION

## SAFETY

Before connecting the appliance to the mains electricity supply make sure that the connection data on the data plate (voltage and frequency) correspond with the mains electricity supply, otherwise the appliance could be damaged. Consult a qualified electrician if in any doubt.

Ensure that the power cord does not come into contact with any hot surfaces, if necessary protect the power cord with a barrier or insulating sleeve.

The socket and on-off switch should be easily accessible after the appliance has been built in.

The warming drawer may only be built in combination with those appliances quoted by Electrolux as being suitable. Electrolux cannot guarantee trouble-free operation if the appliance is operated in combination with appliances other than those quoted by Electrolux as being suitable.

When building in the warming drawer in combination with another suitable appliance, the food warming drawer must be fitted above a fixed interim shelf in the housing unit. Please ensure that the housing unit can support both its weight and that of the other appliance.

As the combination appliance is placed directly on top of the warming drawer once it is built in, an interim shelf is not necessary between the two appliances.

The appliance must be built in so that the contents of the drawer can be seen. This is to avoid scalding from hot food spilling over. There must be enough space for the drawer to be pulled out fully.

Use 4x appropriate screws to fix the warming drawer to the cabinet. Open the warming drawer and screw in the front corners.

When building in the combination appliance, it is essential to follow the instructions given in the operating and installation instructions supplied with the combination appliance.

All dimensions in this instruction booklet are given in mm.

## ENVIRONMENTAL PROTECTION

Unpack the appliance and dispose of the packaging in an environmentally-responsible manner.

This appliance is labelled in accordance with the European Directive 2012/19/EC concerning used electrical and electronic appliances (WEEE – waste electrical and electronic equipment). The guideline determines the framework for the return and recycling of used appliances as applicable.

## TECHNICAL DATA

**Power supply:** 220 -240 V ~  
50-60Hz

**Total connected load:** 1000 W

# INSTALLATION (CONTINUED)

## PRODUCT DIMENSIONS

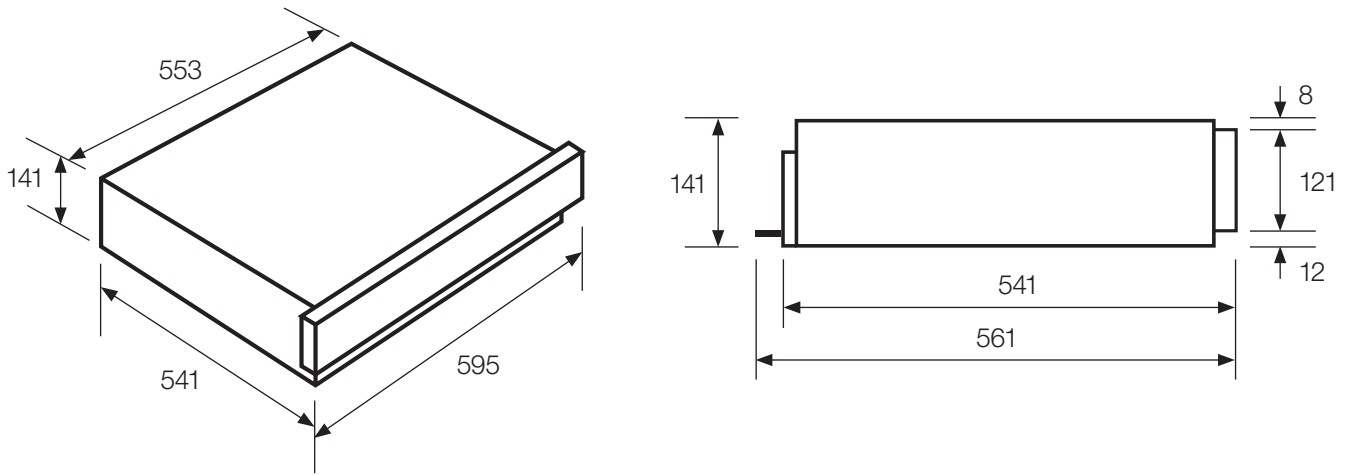

## DIMENSIONS FOR INSTALLING WITH COMPACT OVEN EVEM6546DF

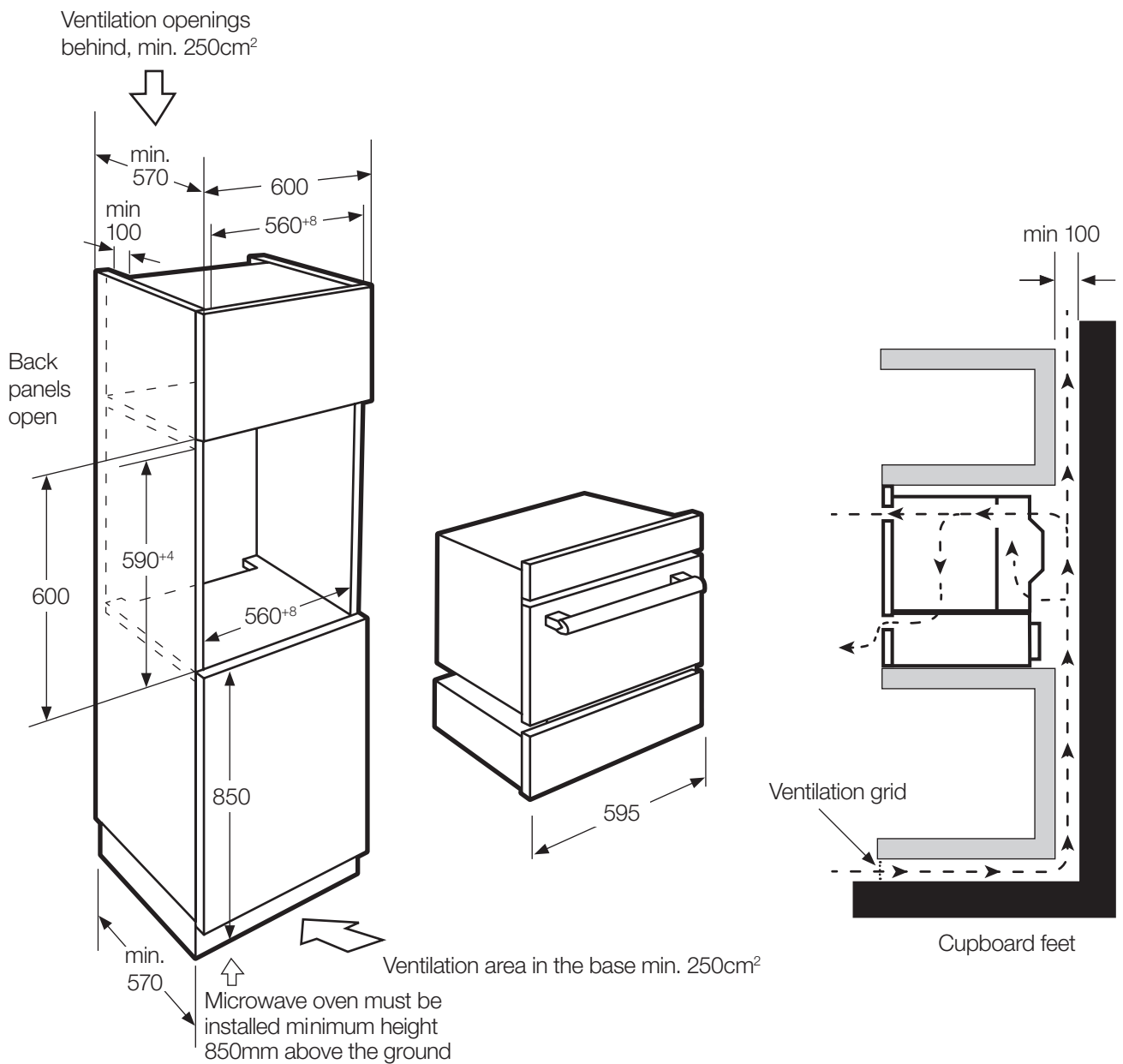

# TROUBLESHOOTING

With the help of the following guide, minor faults in the performance of the appliance, some of which may result from incorrect operation, can be put right without contacting the Service Department.

## WARNING

**Installation work and repairs to electrical appliances must only be carried out by a suitably qualified person in strict accordance with current local and national safety regulations. Repairs and other work by unqualified persons could be dangerous.**

Problem	Possible cause	Remedy
<b>The appliance does not heat up.</b>	The appliance is not correctly plugged in and switched on at the mains socket.	Insert the plug and switch on at the socket.
	The mains fuse has tripped.	Reset the trip switch in the mains fuse box (minimum fuse rating - see data plate). If, after resetting the trip switch in the mains fuse box and switching the appliance back on, the appliance will still not heat up, contact a qualified electrician.
<b>The food is not hot enough.</b>	The temperature setting is too low.	Select a higher temperature.
	The vents are covered.	Ensure that the air can circulate freely.
<b>The food is too hot.</b>	The temperature setting is too high.	Select a lower temperature.
<b>The crockery is not warm enough.</b>	The temperature setting is too low.	Select a higher temperature.
	The vents are covered.	Ensure that the air can circulate freely.
	The crockery has not been allowed to heat up for a sufficiently long time.	Various factors will affect how long the crockery will take to heat up (see "Warming crockery").
<b>The crockery is too hot.</b>	The temperature setting is too high.	Select a lower temperature.
<b>A noise can be heard when the drawer is being used.</b>	The noise is caused by the fan which distributes the heat evenly through the drawer. The fan operates at intervals when the functions for keeping food warm and low temperature cooking are being used.	This is not a fault.

**Electrolux Warranty**

FOR SALES IN AUSTRALIA AND NEW ZEALAND  
 APPLIANCE: ELECTROLUX BUILT-IN CONVECTION MICROWAVE  
 AND BUILT-IN WARMING DRAWER

**This document sets out the terms and conditions of the product warranties for Electrolux Appliances. It is an important document. Please keep it with your proof of purchase documents in a safe place for future reference should there be a manufacturing defect in your Appliance. This warranty is in addition to other rights you may have under the Australian Consumer Law.**

**1. In this warranty:**

- (a) 'ACL' or 'Australian Consumer Law' means Schedule 2 to the Competition and Consumer Act 2010;
- (b) 'Appliance' means any Electrolux product purchased by you and accompanied by this document;
- (c) 'ASC' means Electrolux's authorised serviced centres;
- (d) 'Westinghouse' is the brand controlled by Electrolux Home Products Pty Ltd of 163 O'Riordan Street, Mascot NSW 2020, ABN 51 004 762 341 in respect of Appliances purchased in Australia and Electrolux (NZ) Limited (collectively "Electrolux") of 3-5 Niall Burgess Road, Mount Wellington, in respect of Appliances purchased in New Zealand;
- (e) 'Warranty Period' means the period specified in clause 3 of this warranty;
- (f) 'you' means the purchaser of the Appliance not having purchased the Appliance for re-sale, and 'your' has a corresponding meaning.

**2. Application:** This warranty only applies to new Appliances, purchased and used in Australia or New Zealand and is in addition to (and does not exclude, restrict, or modify in any way) other rights and remedies under a law to which the Appliances or services relate, including any non-excludable statutory guarantees in Australia and New Zealand.

**3. Warranty Period:** Subject to these terms and conditions, this warranty continues for in Australia for a period of 36 months and in New Zealand for a period of 36 months, following the date of original purchase of the Appliance.

**4. Repair or replace warranty:** Repair or replace warranty: During the Warranty Period, Electrolux or its ASC will, at no extra charge if your Appliance is readily accessible for service, without special equipment and subject to these terms and conditions, repair or replace any parts which it considers to be defective. Electrolux or its ASC may use refurbished parts to repair your Appliance. You agree that any replaced Appliances or parts become the property of Electrolux

**5. Travel and transportation costs:** Subject to clause 7, Electrolux will bear the reasonable cost of transportation, travel and delivery of the Appliance to and from Electrolux or its ASC. Travel and transportation will be arranged by Electrolux as part of any valid warranty claim.

**6. Proof of purchase** is required before you can make a claim under this warranty.

**7. Exclusions:** You may not make a claim under this warranty unless the defect claimed is due to faulty or defective parts or workmanship. This warranty does not cover:

- (a) light globes, batteries, filters or similar perishable parts;
- (b) parts and Appliances not supplied by Electrolux;
- (c) cosmetic damage which does not affect the operation of the Appliance;
- (d) damage to the Appliance caused by:
  - (i) negligence or accident;

- (ii) misuse or abuse, including failure to properly maintain or service;
- (iii) improper, negligent or faulty servicing or repair works done by anyone other than an Electrolux authorised repairer or ASC;
- (iv) normal wear and tear;
- (v) power surges, electrical storm damage or incorrect power supply;
- (vi) incomplete or improper installation;
- (vii) incorrect, improper or inappropriate operation;
- (viii) insect or vermin infestation;
- (ix) failure to comply with any additional instructions supplied with the Appliance;

In addition, Electrolux is not liable under this warranty if:

- (a) the Appliance has been, or Electrolux reasonably believes that the Appliance has been, used for purposes other than those for which the Appliance was intended, including where the Appliance has been used for any non-domestic purpose;
- (b) the Appliance is modified without authority from Electrolux in writing;
- (c) the Appliance's serial number or warranty seal has been removed or defaced.

**8. How to claim under this warranty:** To enquire about claiming under this warranty, please follow these steps:

- (a) carefully check the operating instructions, user manual and the terms of this warranty;
- (b) have the model and serial number of the Appliance available;
- (c) have the proof of purchase (e.g. an invoice) available;
- (d) telephone the numbers shown below.

**9. Australia:** For Appliances and services provided by Electrolux in Australia: Electrolux goods come with guarantees that cannot be excluded under the Australian Consumer Law. You are entitled to a replacement or refund for a major failure and for compensation for any other reasonably foreseeable loss or damage. You are also entitled to have the Appliance repaired or replaced if the Appliance fails to be of acceptable quality and the failure does not amount to a major failure. 'Acceptable quality' and 'major failure' have the same meaning as referred to in the ACL.

**10. New Zealand:** For Appliances and services provided by Electrolux in New Zealand, the Appliances come with a guarantee by Electrolux pursuant to the provisions of the Consumer Guarantees Act, the Sale of Goods Act and the Fair Trading Act. Where the Appliance was purchased in New Zealand for commercial purposes the Consumer Guarantee Act does not apply.

**11. Confidentiality:** You accept that if you make a warranty claim, Electrolux and its agents including ASC may exchange information in relation to you to enable Electrolux to meet its obligations under this warranty. You accept that if you make a warranty claim, Electrolux and its agents including ASC may exchange information in relation to you to enable Electrolux to meet its obligations under this warranty. For more information on how we handle your personal information, see our privacy policy at [www.electrolux.com.au/other/privacy/](http://www.electrolux.com.au/other/privacy/) and [www.electrolux.co.nz/other/privacy/](http://www.electrolux.co.nz/other/privacy/)

**Important Notice**

Before calling for service, please ensure that the steps listed in clause 8 above have been followed.

<p><b>FOR SERVICE</b>            or to find the address of your nearest authorised service centre in Australia  <b>PLEASE CALL 13 13 49</b>            For the cost of a local call (Australia only)</p>	<p><b>AUSTRALIA</b>            ELECTROLUX HOME PRODUCTS            163 O'Riordan Street, Mascot NSW 2020            electrolux.com.au</p>	<p><b>FOR SPARE PARTS</b>            or to find the address of your nearest spare parts centre in Australia  <b>PLEASE CALL 13 13 50</b>            For the cost of a local call (Australia only)</p>
<p><b>FOR SERVICE</b>            or to find the address of your nearest authorised service centre in New Zealand  <b>PLEASE CALL 0800 10 66 10</b>            (New Zealand only)</p>	<p><b>NEW ZEALAND</b>            ELECTROLUX (NZ) Limited            3-5 Niall Burgess Road, Mount Wellington            electrolux.co.nz</p>	<p><b>FOR SPARE PARTS</b>            or to find the address of your nearest spare parts centre in New Zealand  <b>PLEASE CALL 0800 10 66 20</b>            (New Zealand only)</p>

**Electrolux Home Products Australia**

telephone: 1300 363 640  
fax: 1800 350 067  
email: [customercare@electrolux.com.au](mailto:customercare@electrolux.com.au)  
web: [electrolux.com.au](http://electrolux.com.au)

**shop.electrolux.com.au**



**Electrolux Home Products New Zealand**

telephone: 0800 436 245  
fax: 0800 225 088  
email: [customercare@electrolux.co.nz](mailto:customercare@electrolux.co.nz)  
web: [electrolux.co.nz](http://electrolux.co.nz)



To add a touch of professional inspiration to your home, visit [electrolux.com.au](http://electrolux.com.au) or [electrolux.co.nz](http://electrolux.co.nz)

[electrolux.com.au](http://electrolux.com.au)



or [electrolux.co.nz](http://electrolux.co.nz)

