

Billi™

User guide
Billi Quadra & Quadra Plus
Tap options XL, XT, XR



User guide

Billi Quadra & Quadra Plus – XL, XT, XR.

Contents

| | |
|----------------------------------|-----|
| Warnings & Important information | 2 |
| General Maintenance | 3 |
| Features and Modes | 4 |
| Tap Options & Operation | |
| XL Tap | 5 |
| XT Tap | 5 |
| XR Tap | 5 |
| Set up instructions | |
| XL Tap | 6-7 |
| XT Tap | 6-7 |
| XR Tap | 6-7 |
| Filtration information | 8 |
| Changing the filter | 9 |
| Quadra Plus | 10 |
| Service Support | 10 |

Warnings & Important information

- For continued safety of this appliance it must be installed, operated and maintained in accordance with the manufacturer's instructions.
- Your appliance should be installed by a suitably qualified tradesperson.
- For correct operation of this appliance it is essential to observe the instructions as outlined in this booklet.
- Do not use this appliance with water that is microbiologically unsafe or with water of unknown quality without adequate disinfection before or after the system. Systems certified for cyst reduction may be used on disinfected water that may contain filterable cysts.
- Filter replacement must be performed at intervals of not more than 12 months.
- Use this appliance only as directed in these instructions and only for its designed purpose.
- This appliance is not intended for use by persons (including children) with reduced physical, sensory or mental capabilities, or lack of experience and knowledge, unless they have been given supervision or instruction concerning use of the appliance by a person responsible for their safety.
- This appliance is not suitable in an area where a water jet could be used.
- Children should be supervised to ensure that they do not play with the appliance.
- **DANGER:** The operation of the thermal cut-out indicates a possibly dangerous situation. Do not reset the thermal cut-out until the water heater has been serviced by a suitably qualified person.
- **WARNING:** Do not connect any restrictor or pressure relief device to the vent pipe of this water heater if installed.

User guide

Billi Quadra & Quadra Plus – XL, XT, XR.

- If the supply cord is damaged, it must be replaced by the manufacturer, its service agent or similarly qualified persons in order to avoid creation of a hazard.
- Billi hose sets as supplied with the appliance are to be used. Old or other manufacturer's hose sets should not be re-used.
- If the appliance is located where the ambient air temperature could fall below 4°C when the heater is not in use, do not turn off the power supply to the appliance. This safeguard does not offer the same protection to the connecting pipework and fittings.
- The ambient temperatures this unit should operate within are 5°C to 30°C.
- **Turn off power to unit, by unplugging the power cord from the power point, if water supply is turned off**

Caution and safety

Boiling water is dangerous and can cause severe burns, particularly with young children. Boiling water must always be handled with caution. Use this appliance only as directed in these instructions and only for the purpose for which it has been designed. Your Billi Quadra is designed to be safe and practical. In an environment with young children, it is recommended that the boiling water safety switch is activated.

The following safety features have been included:

- Ergonomic levers
- Levers/touch activations located safely above water outlet.
- Smooth electronically controlled boiling water flow rate. Flow is briefly reduced as water first enters cup to prevent splashing.
- Dispenser remains cool to touch.
- Childproof safety switch.
- Boiling water Safety Isolation mode.

General Maintenance

Your Billi Quadra has been designed to require minimal maintenance other than replacement of filter cartridges. During each filter change, check all water connection fittings for signs of leakage. Check all tubing for any signs of damage. Check the cupboard area around the base of unit for any signs of moisture. For air cooled units, ensure side vents of the under bench module are kept clear and airflow is not obstructed. Restricted airflow will cause inefficient operation of the refrigeration system.

—Cleaning the dispenser

Your Billi Quadra Dispenser is fabricated from solid zinc casting material with tough protective chrome plating. Proper care of the Billi Electronic dispenser crucial; Avoid using abrasive cleaners. Wipe clean using a damp cloth. Use of a non-solvent, non-smearing cleaner such as Windex is recommended. Do not pour water over dispenser.

Cupboard ventilation requirements

Your Billi Quadra underbench module requires no cupboard ventilation but requires air space around the unit of 10mm. Care should be taken when using the cupboard space, to avoid stretching or damaging plastic pipe work. Check fittings and tubing at each filter change for signs of damage or leakage. Always ensure access to power switch and water supply tap is not restricted.

User guide

Billi Quadra & Quadra Plus – XL, XT, XR.

Features and Modes

XL

Your Quadra dispenser is simply operated with position-sensitive levers. The Red dot on the left indicates hot water and the blue on the right indicates cold. Hot and cold levers can either be lifted or depressed. When lifted, the levers will latch for continuous delivery until released with a light press. The Quadra will not dispense hot and cold water simultaneously. Water will not flow if both levers are pressed together.

XT, XR

The XT and XR dispenser is operated with capacitive touch buttons. Red and blue buttons indicate the boiling and chilled water.

Red and blue buttons can be pressed and held for momentary dispensing or double tapped for continuous flow. Water will not flow if both buttons are held together.

Dispenser swivel

The Quadra dispenser incorporates a swivel function, allowing the dispenser to be swung out of the way if more sink space is required. A central position stop provides positive location during normal usage.

Safety timeout

Your Billi Quadra incorporates a water delivery Safety Timeout to prevent an uncontrolled flow of water. Water flow stops automatically after a set time interval. Flow can be started again by releasing and pressing the dispenser lever or button.

Boiling water timeout – 10 secs;

Chilled water – 1 minute.

Childproof safety switch

Your Billi Quadra is fitted with a childproof safety lock-out feature to protect against accidental dispensing of boiling water and the risk of burns. Please refer to page 7 to set up.

Water delivery temperatures

The boiling and chilled water temperatures can be adjusted to suit individual preferences. Hot water temperature range: 80°C – 98.9°C
Cold water temperature range: 6°C – 20°C

Time switch

Your Billi Quadra incorporates an energy saving time switch. This function allows the Quadra to automatically turn ON and OFF at selected times. Individual days can be set to be active or non-active. The green lightning bolt indicates that the time switch is set. Refer to Setting Instructions, page 6.

Standby mode

An energy saving Standby mode can be selected to activate after a period of non-use. Once activated, the boiling water temperature can drop to 80°C and the chilled water temperature can rise to 15°C. A touch of either dispenser lever or button cancels the standby and the Quadra resumes its normal operating mode to deliver boiling or chilled water. The time needed to elapse before the Quadra enters this mode can be varied. During Standby mode, the green moon and stars icon will be illuminated. Refer to Options, page 7.

User guide

Billi Quadra & Quadra Plus – XL.



Dispenser Icons

Orange dot.

Flashes when filter change due. On constant when overdue.

Red lock illuminated.

Safety button activated. To use, press the indent on the back of the tap momentarily & lift or press the boiling lever.

Green lightning bolt illuminated.

Time-switch on.

Green moon & stars illuminated.

In standby mode.

Time-switch can be used with the standby mode therefore both can be illuminated at the same time.

Red dot.

Flashes when heating up to temperature. On constant when boiling water ready.

Blue dot.

Flashes when chilling. On constant when chilled water ready.

Red & blue dots will flash yellow if the unit goes into fault.

User guide

Billi Quadra & Quadra Plus – XT, XR.



Dispenser Icons

Orange dot.

Flashes when filter change due. On constant when overdue.

Red lock illuminated.

Safety button activated. To use, press the red lock icon on the top of the tap momentarily & press the red button (left).

Green lightning bolt illuminated.

Time-switch on.

Green moon & stars illuminated.

In standby mode.

Time-switch can be used with the standby mode therefore both can be illuminated at the same time.

Red ring.

Flashes when heating up to temperature. On constant when boiling water ready.

Blue ring.

Flashes when chilling. On constant when chilled water ready.

Red & blue rings will flash yellow if the unit goes into fault.



User guide

Billi Quadra & Quadra Plus – XL, XT, XR.

Set up Instructions

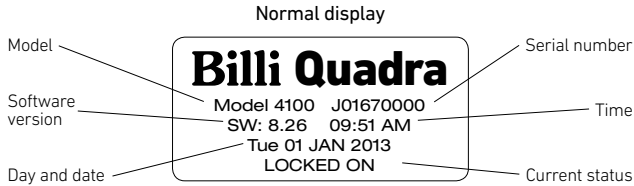
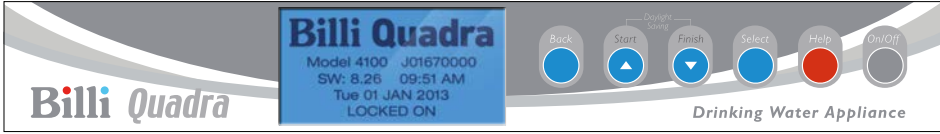

Normal Display Current status may be displayed as follows

TIMESWITCH ON/OFF Indicates the Quadra has been switched ON or OFF by the inbuilt time switch control. During OFF mode, the dispenser icons are off and give a brief orange flash once every 10 seconds.

OVERRIDE ON/OFF The Quadra can be manually turned ON or OFF by pressing the ● ON/OFF button. The status remains as selected for a period of 2 hours, after which it returns to automatic ON/OFF control.

LOCKED ON/OFF The ON/OFF status can be permanently locked ON or OFF. Use ON if 24 hour, 7 days a week service is required; or OFF if user is going away for an extended period. To activate or deactivate: press the ● ON/OFF button and hold down until the required status is displayed.

SAFETY SWITCH The child proof safety Switch mode has been activated. To set, refer to Options, page 7.

STANDBY A period of non-use has elapsed and the Quadra has switched to the energy saving standby mode.

Daylight saving

Time adjustment for daylight saving is made by pressing either the START or FINISH buttons at the beginning or end of daylight saving.

Menu

To access the menu, press the ● SELECT button. The menu functions are:

- To move the highlighted cursor, press the ▲ or ▼ buttons.
- To activate the highlighted cursor, press ● SELECT.
- To return to previous screen, press ● BACK.

—Setting time and date

Screen shows currently set time, day and date.







- Press ▲ or ▼ buttons to move the highlighted cursor.
- Press ● SELECT to activate. The highlighted item flashes.
- When flashing, press ▲ or ▼ to change setting.
- Press ● SELECT. Highlighted cursor stops flashing. Cursor automatically advances to next setting. Repeat above activation procedure.
- Press ● BACK once to return to previous screen or twice to return to normal display.

User guide



Billi Quadra & Quadra Plus – XL, XT, XR.

Setting time switch

Screen shows active and non-active days. Turn-on and Turn-off times for active days are displayed.

- Press  or  buttons to move the highlighted cursor.
- Press  SELECT to activate. The highlighted item flashes.
- When flashing, press  or  to change setting.
- Press  SELECT to confirm and advance to next setting. Repeat above activation procedure.
- Press  BACK twice to return to normal display.

Options

The screen displays the following options and settings. Press ,  and  buttons to select and activate or alter the required setting.

- Safety Switch: Childproof safety switch is activated by selecting ON.
- Hot Temp Set: Hot water temperature can be set between 80°C and 98.9°C.
- Cold Temp Set: Cold water temperature can be set between 6°C and 20°C.
- Standby Mode: Activated by selecting ON.
- Standby Time Set: Period of non-use before standby mode is activated. Range 0.5 to 4.0 hours.
- Filter Change Help: Step-by-step graphic instructions showing filter change procedure.
- Filter Flush: Automatic flush cycle to clean filters after 2 days of non-use.

Statistics

Screen displays information only.

- Hot, Cold: Temperature of boiling and chilled water.
- Hot Cups: Total number of boiling water cups dispensed.
- Cold Cups: Total number of cold water cups dispensed.
- Filter Life Remaining: No. of cups or days to go before change filter warning flashes.
- Cups this filter: Cups current filter has dispensed.

- Start: Date unit began to be used.
- S/W: Software version installed.

Initial Setup

For use only by the installer when setting initial operating parameters.

Billi Filter Cartridges

All Billi Quadra models feature the Billi swing-change filtration system. The Quadra is fitted with a single filter. The filters use Fibredyne™ technology which is fibrous and matted together, increasing the surface area of the carbon, meaning there is greater contact time and improved quality of filtration. It incorporates five stage filtration, removing sediment and chemical elements as well as enabling minerals to flow through the appliance without allowing scale build up and arresting the growth of bacterial microorganisms such as giardia and cryptosporidium.

Use only genuine filters as designed for this system. All drinking water filtration systems should be flushed after a period of non-use. Your Billi Quadra has an automatic flushing cycle which can be activated. Refer to Options above. After a period of non-use of more than two days, e.g. off Saturday and Sunday, the cold water will flow for 90 seconds when the time switch first turns the unit on. Alternatively, before use, flush and run until water flow stops, then release the lever.

*(subject to water quality).

User guide

Billi Quadra & Quadra Plus – XL, XT, XR.

—Filter Change Due Monitor

The Quadra filter change due monitor operates by counting the number of cups dispensed and the number of days elapsed until a pre-set level is reached. Once reached, the dispenser icons will briefly change to orange once every five seconds. The Quadra will continue to operate while the filter indicator is flashing. Water filters installed in areas with higher levels of turbidity (cloudiness/sediment) will experience a reduced service life. The flow from the cold water outlet will decrease as the filters become blocked. It may be necessary to change filters before the change filter indicator flashes. The filter monitor can be reprogrammed to an appropriate service interval if required. Contact Billi Australia Pty Ltd.

Standard 5 micron-rated filters generally have a longer service life than Premium sub micron-rated filters.

If particularly dirty water is noticed coming through the water supply, e.g. from other tap ware, as sometimes occurs following repairs to local water mains, immediately turn your Billi Quadra off using the ON/OFF button. This will help prevent premature blocking of the filter cartridges.

—Replacement of Filter Cartridges

Periodic replacement of your Billi Quadra's Water Filter Cartridges is necessary to maintain the sparkling cleanliness and purity of your drinking water.

A replacement filter change service is available. To arrange, contact the Billi Service centre on 1800 812 321.

If you wish to install the replacement filter cartridges yourself, filters can be purchased online at www.billi.com.au or through a certified agent which will provide genuine Billi replacement filter cartridge sets.

To assist with the replacement of your Quadra filter cartridge, a series of moving graphic instruction screens will guide you through the required steps. Press HELP if display indicates 'Filter Change Due' or refer to Options, page 10 mode to select 'Filter Change Help'.

Once the new filter has been installed and the filter flush cycle is complete, check for any water leakage around the filter system. Take particular care to ensure the area around the water leakage sensor, located on the lower left hand side of the bulkhead behind the filters, is dry. If you have any questions, or concerns during the filter change process simply contact Billi's experienced technical assistance team on 1800 812 321.

Billi Filter Cartridges – Reduces & Removal

| Filter Type | Order Part No. | Micr. | Filters | Sediment | Chlorine | VOCs | Chemicals | Taste Odour | Fluoride Minerals | Expected Life |
|-------------|----------------|-------|---------|----------|----------|------|-----------|-------------|-------------------|---------------|
| Prem. | 994002 | 0.2 | Single | ✓ | ✓ | ✓ | ✓ | ✓ | Slight | 6 - 12 months |
| Stand. | 994001 | 5.0 | Single | ✓ | ✓ | ✗ | ✓ | ✓ | ✗ | 6 - 12 months |

User guide

Billi Quadra & Quadra Plus – XL, XT, XR.

Filter removal and replacement instructions

Important note: Please ensure you remove the foam packing under the filter before installing.

1. Remove the front cover (see Diagram 1).
2. Press & hold the ON/OFF button until the LCD screen says **VERRIDE OFF**. Leave the power supply on.
3. Remove the filter (and filter bypass insert if required) (see Diagram 2).
 - a. Hold the bottom of the filter (and filter bypass insert if required) and pull towards you slowly. The top of the filter is a hinged cradle assembly. It should stop after approximately 30 degrees of travel.
 - b. Pull down until it pops out.
4. If water spills in the tray at the base of the filter, soak it up with a cloth or sponge.
5. If single filter, fit the new filter by pushing right up into the cradle & pulling back until it locks into place.
6. Unit will now begin an automatic flush cycle.
7. Check for any leaks from around the filter, hosing or pipeworks.
8. Replace the front cover.
9. Once the lights stop flashing, your system is ready to use.

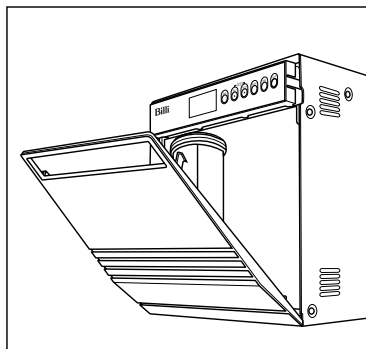

Diagram 1

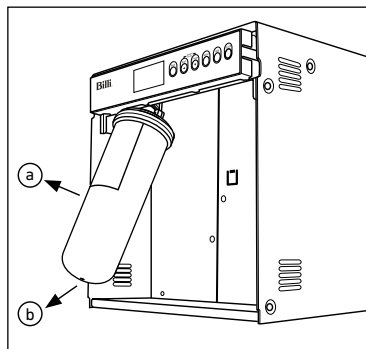

Diagram 2

User guide

Billi Quadra & Quadra Plus – XL, XT, XR.

Quadra Plus

If you have installed a Billi Quadra Plus 5, Plus 9 or Plus 15, you will enjoy the benefit of instant hot water from your sink mixer tap ware. When delivering hot water, the Quadra Plus draws boiling water from the internal storage tank, pre-mixing it with cold water, to deliver hot water up to 50°C.

If the delivery capacity of the system is exceeded, the hot water will run cold with bubbling being evident. At this point there is still extra boiling water available for delivery from the Quadra dispenser. Recovery is rapid and additional hot water will be available after a short period of time.

Service Support

Your Billi Quadra incorporates a fault detection and diagnosis system. Should a fault occur, a message will be displayed describing the fault. Pressing the HELP button will advise you of any checks that can be performed.

If a service call needs to be logged, note the message displayed and report this when booking the call. This will assist the technician in coming prepared to rectify the problem.

For technical support please call 1800 812 321 and speak to one of Billi's experienced technician's.

To book a service call out request a filter change or please contact the Billi Service Centre on 1800 812 321 or book online at www.billi.com.au

For information on our filtration and service contracts please contact Billi Head Office on 1800 812 321 or email us at service@billi.com.au.

Filter cartridges are also available for purchase online at www.billi.com.au

Billi™

Billi Australia Pty Ltd
42 Lucknow Crescent, Thomastown
Victoria 3074 Australia

Telephone +61 3 9469 0400
Facsimile +61 3 9469 0499

www.billi.com.au

Designed and manufactured in Australia.

As Billi Australia Pty Ltd has a policy of continual improvement, all details are subject to change without notice. All goods are sold subject to our published terms and conditions. Billi is a registered trademark. 0618