

SAMSUNG

User guide

S27H70* S27H80*EA S27H80*UA S27H80*EF S40H85*T
S32H70* S32H80*EA S32H80*UA

The color and the appearance may differ depending on the product, and the content in the manual is subject to change without prior notice to improve the performance.

© Samsung

Samsung owns the copyright for this manual.

Use or reproduction of this manual in parts or entirety without the authorization of Samsung is prohibited.

Trademarks other than that of Samsung are owned by their respective owners.



Table of contents

Before Using the Product

Safety Precautions	4
Electricity and Safety	4
Installation	5
Operation	6

Cleaning	8
----------	---

Correct posture to use the product	9
------------------------------------	---

Product Overview

Direct Key Guide	11
------------------	----

Ports	12
-------	----

Installation

Attaching the Stand	14
Precautions for moving the product	17
Checking the space around the product	18
Adjusting the Product Tilt and Height	19
Rotating the Product	21
Anti-theft Lock	22
Wall Mount Kit Specifications (VESA)	23

Installing the Software	24
Samsung Display Manager	24
Driver Installation	24

Connections

Read below before connecting the product.	25
---	----

Connecting and Using a PC	25
Connection Using the HDMI Cable	25
Connection Using an DP Cable	26
Connecting to headphones or earphones	26
Connecting the Power	26
Connection Using the USB Type-C Cable	27
Connection Using a Thunderbolt™ 5 Cable or USB Type-C Cable	28
Connecting the Dual display (daisy chain)	29
Connecting the Product to a PC as a USB HUB	29

Tidying Up the Cables	30
-----------------------	----

Setting Optimum Resolution	31
----------------------------	----

Table of contents

Configuring Menu Settings

Picture	32
Eye Care	36
PIP/PBP	37
OnScreen Display	38
System	38
Support	41

Troubleshooting

Requirements Before Contacting Samsung Customer Service Center	43
Check the following.	43
Installation issue (PC mode)	43
Screen issue	44
Sound issue	45
Source device issue	45
Other issue	45

Specifications

General	46
List of graphic cards supporting HDR10	48
Licenses & Other Information	48
Standard Signal Mode Table	49

Appendix

Responsibility for the Pay Service (Cost to Customers)	52
FreeSync (for AMD graphics card)	53
Adaptive-Sync (for NVIDIA graphics card)	54
TCO CERTIFIED	55
Say hello to a more sustainable product	55
Product warranty information	55
Software updates	55

Before Using the Product

Safety Precautions

Warning

A serious or fatal injury may result if instructions are not followed.







Caution

Personal injury or damage to properties may result if instructions are not followed.

CAUTION









RISK OF ELECTRIC SHOCK. DO NOT OPEN.

CAUTION: TO REDUCE THE RISK OF ELECTRIC SHOCK, DO NOT REMOVE COVER (OR BACK). THERE ARE NO USER SERVICEABLE PARTS INSIDE. REFER ALL SERVICING TO QUALIFIED PERSONNEL.





	This symbol indicates that high voltage is present inside. It is dangerous to make any kind of contact with any internal part of this product.		AC voltage: Rated voltage marked with this symbol is AC voltage.
	This symbol indicates that this product has included important literature concerning operation and maintenance.		DC voltage: Rated voltage marked with this symbol is DC voltage.
	Class II product: This symbol indicates that a safety connection to electrical earth (ground) is not required. If this symbol is not present on a product with a mains lead, the product MUST have a reliable connection to protective earth (ground).		Caution. Consult instructions for use: This symbol instructs the user to consult the user manual for further safety related information.

Electricity and Safety

Warning









-  Do not use a damaged power cord or plug, or a loose power socket.
-  Do not use multiple products with a single power socket.
-  Do not handle the power cord with a wet body part.
-  Do not bend or pull the power cord with force. Be careful not to leave the power cord under a heavy object.
-  Do not place the power cord or product near heat sources.
-  Insert the power plug all the way in so it is not loose.
-  Connect the power plug to a grounded power socket (type 1 insulated devices only).
-  Clean any dust around the pins of the power plug or the power socket with a dry cloth.

Caution







-  Do not disconnect the power cord while the product is being used.
-  Only use the power cord provided with your product by Samsung. Do not use the power cord with other products.
-  Keep the power socket where the power cord is connected unobstructed.
The power cord must be disconnected to cut off power to the product when an issue occurs.
-  Hold the plug when disconnecting the power cord from the power socket.

Installation

Warning







-  DO NOT PLACE CANDLES, INSECT REPELLANTS OR CIGARETTES ON TOP OF THE PRODUCT.
DO NOT INSTALL THE PRODUCT NEAR HEAT SOURCES.
-  Do not install the product in poorly ventilated spaces such as a bookcase or closet.
-  Do not install the product on an unstable or vibrating surface (insecure shelf, sloped surface, etc.)
 - The product may fall and become damaged or cause an injury.
 - Using the product in an area with excess vibration may damage the product or cause a fire.
-  Do not expose the product to direct sunlight, heat, or a hot object such as a stove.
The product lifespan may be reduced or a fire may result.
-  Edible oil, such as soybean oil, can damage or deform the product. Do not install the product in a kitchen or near a kitchen counter.
-  Install the product at least 10cm away from the wall to allow ventilation.
-  Discard the plastic packaging that the product is packaged in, immediately after unpacking.
Plastic packaging material can cause suffocation if it is handled improperly.
-  Do not install the product in a vehicle or a place exposed to dust, moisture (water drips, etc.), oil, or smoke.

Caution

-  Do not set down the product on its front.
-  When installing the product on a cabinet or shelf, make sure that the bottom edge of the front of the product is not protruding.
 - The product may fall and become damaged or cause an injury.
 - Install the product only on cabinets or shelves of the right size.
-  Before assembling the product, place the product down on a flat and stable surface so that the screen is facing downwards.
 - The product is curved. Placing pressure on the product when on a flat surface may damage the product. When the product is on the ground facing up or down, do not put pressure on it.
-  In the same series, the color can vary depending on the size.
-  Do not drop the product while moving.
-  Set down the product gently.
Product failure or personal injury may result.
-  Installing the product in an unusual place (a place exposed to a lot of fine dust, chemical substances, extreme temperatures or a significant presence of moisture, or a place where the product will operate continuously for an extended period of time) may seriously affect its performance.
Be sure to consult Samsung Customer Service Center if you want to install the product at such a place.

Operation

Warning

-  There is a high voltage inside the product. Never disassemble, repair or modify the product yourself.
Contact Samsung Customer Service Center for repairs.
-  Do not hang on to or climb on the product.
The product may tip over or fall, causing injury or death.
-  If the product is dropped or the outer case is damaged, turn off the power and disconnect the power cord. Then contact Samsung Customer Service Center.
Continued use can result in a fire or electric shock.
-  Do not put heavy objects, toys or snacks on top of the product.
Hanging on to the product to get a toy or snack may cause heavy objects to fall or the product to tip over, resulting in injury or death.
-  Do not move the product by pulling the power cord or any cable.
-  Do not lift or move the product by pulling the power cord or any cable.
-  Ensure the vents are not blocked by tablecloths or curtains.
An increased internal temperature may cause a fire.

 Do not insert metallic objects (chopsticks, coins, hairpins, etc) or objects that burn easily (paper, matches, etc) into the product (through the vent or input/output ports, etc).

Be sure to power off the product and disconnect the power cord when water or other foreign substances have entered the product. Then contact Samsung Customer Service Center.

 Do not place objects containing liquid (vases, pots, bottles, etc) or metallic objects on top of the product.

Be sure to power off the product and disconnect the power cord when water or other foreign substances have entered the product. Then contact Samsung Customer Service Center.

 Do not use liquid fumigators containing chemicals, such as mosquito repellent or air freshener, around the product.

If steam comes in contact with the product surface or enters the product, it may cause stains or malfunction.

 To move the product, first disconnect all the cables from it, including the power cord.

 If the product generates abnormal sounds, a burning smell or smoke, disconnect the power cord immediately and contact Samsung Customer Service Center.

 During a lightning or thunderstorm, power off the product and remove the power cord.

 Do not drop objects on the product or apply impact.

 If a gas leakage is found, do not touch the product or power plug. Also, ventilate the area immediately.

Caution

 Do not put AC/DC adapters together.

 Remove the plastic bag from the AC/DC adapter before you use it.

 Do not let water enter the AC/DC adapter device or get the device wet.

- An electric shock or fire may result.
- Avoid using the product outdoors where it can be exposed to rain or snow.
- Be careful not to get the AC/DC adapter wet when you wash the floor.

 Do not put the AC/DC adapter near to any heating apparatus.
Otherwise, a fire may result.











 Do not hold the product upside-down or move it by holding the stand.
The product may fall and become damaged or cause an injury.

 Do not use humidifiers or stoves around the product.

 Do not touch the screen when the product has been turned on for an extended period of time as it will become hot.

 Do not place heavy objects on the product.
Product failure or personal injury may result.

 When using headphones or earphones, do not turn the volume too high.
Having the sound too loud may damage your hearing.

-
-  Leaving the screen fixed on a stationary image for an extended period of time may cause afterimage burn-in or defective pixels.
Set the screen to power-saving mode or moving-picture screen saver when not using the product for an extended period of time.
 -  Disconnect the power cord from the power socket if you do not plan on using the product for an extended period of time (vacation, etc).
Dust accumulation combined with heat can cause a fire, electric shock or electric leakage.
 -  Use the product at the recommended resolution and frequency.
Your eyesight may deteriorate.
 -  Keep the AC/DC adapter in a well-ventilated area.
 -  If you place the AC/DC power adapter hanging with the cord input facing upwards, water or other foreign substances could enter the Adapter and cause the Adapter to malfunction.
Make sure to rest the AC/DC power adapter flat on a table or the floor.
 -  Looking at the screen too close for an extended period of time can deteriorate your eyesight.
 -  Take a break for at least 5 minutes after using the product for 1 hour.
 -  Exercise caution when storing the remote control batteries and small accessories, so they are not swallowed.
If swallowed, consult a physician immediately.
 -  Exercise caution when adjusting the product angle.
 - Parts of the human body may become caught and could be injured.
 - Tilting the product at an excessive angle may cause the product to fall and an injury may result.
 -  Do not use or keep combustible spray or an inflammable substance near the product.

Cleaning

High-glossy models can develop white stains on the surface if an ultrasonic wave humidifier is used nearby.

— Contact your nearest Samsung Customer Service Center if you want to clean the inside of the product (Service fee will be charged.)

Do not press the monitor screen. There is a risk of damaging it.

— Exercise care when cleaning as the panel and exterior of advanced LCDs are easily scratched.

Take the following steps when cleaning.



- 1 Power off the product and PC.
- 2 Disconnect the power cord from the product.
 - When removing the power cord, hold the plug. Never hold the plug with a wet body part. Otherwise, an electric shock may result.
- 3 Wipe the product with a clean, soft and dry cloth.
Wet a soft cloth in water, wring it out well, and then use the cloth to wipe the exterior of the product clean.
 - Do not apply a cleaning agent that contains alcohol, solvent, or surfactant to the product.
 - Do not spray water or detergent directly on the product.
- 4 Connect the power cord to the product when cleaning is finished.
- 5 Power on the product and PC.

Correct posture to use the product

Use the product in the correct posture as follows:

- Straighten your back.
- Allow a distance of 45 to 50cm between your eye and the screen, and look slightly downward at the screen.
- Keep your eyes directly in front of the screen.
- Adjust the angle so light does not reflect on the screen.
- Keep your forearms perpendicular to your upper arms and level with the back of your hands.
- Keep your elbows at about a right angle.
- Adjust the height of the product so you can keep your knees bent at 90 degrees or more, your heels attached to the floor, and your arms lower than your heart.
- Do the Eye exercises or blink frequently, then eye fatigue will be relieved.

Product Overview

- The color and shape of parts may differ from what is shown. Specifications are subject to change without notice to improve quality.
- You can turn on the product with the  button, and then use the Function Key Guide. Function Key Guide appears when the  button is pressed while the product is On.

S27H70* / S32H70*

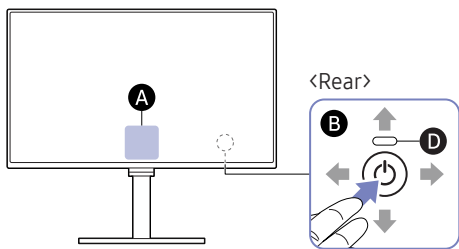



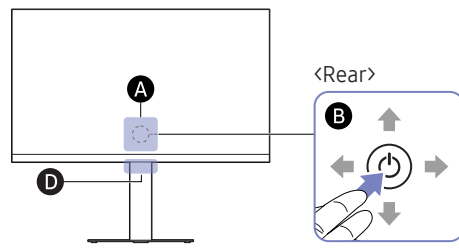



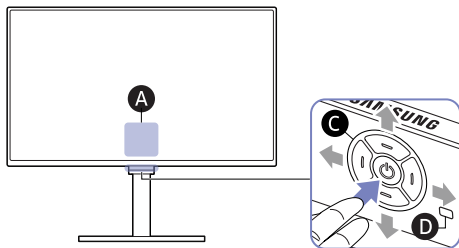

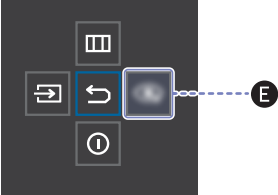











S27H80*EA / S32H80*EA / S27H80*UA / S32H80*UA / S27H80*EF



S40H85*T



Location	Description
	<p>When the screen is on, press the  Button to display the Function Key Guide.</p> <ul style="list-style-type: none"> The location of the Function Key Guide may vary depending on the model.  <ul style="list-style-type: none">  Custom Key is used to directly access the function set in Setup Custom Key. <ul style="list-style-type: none"> Setup Custom Key <ul style="list-style-type: none"> Go to  → System → Setup Custom Key and change the custom key.  Displays the main on-screen menu.  Changes the input source. A message will appear on the top left corner of the screen if the input source has been changed.  Exits from the menu page.  Turns off the product.
	<p> Use this multi-directional button to turn on the power or navigate menus.</p> <ul style="list-style-type: none">  : UP /  : DOWN /  : LEFT /  : RIGHT The location of the button may vary depending on the model.
	<p>5-Way Button: Multi directional button that helps navigate.</p> <ul style="list-style-type: none">  : DOWN(FRONT) /  : UP(REAR) /  : LEFT /  : RIGHT
	<p>Power LED: This LED is power status indicator.</p> <ul style="list-style-type: none"> You can select the power LED operation to be enabled or disabled on the menu screen. ( → System → Power LED On)

Direct Key Guide

On the Direct Key Guide screen, the following menu options appear when the product screen is switched on or the input source is changed.

S27H70* / S32H70* / S27H80*EA / S32H80*EA

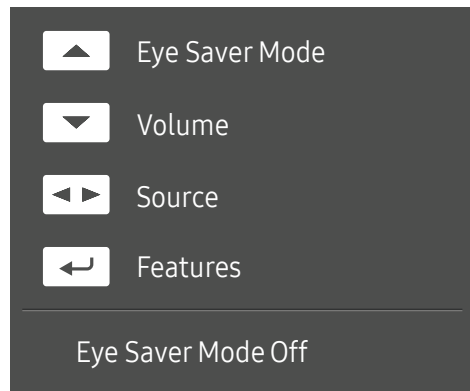

The Direct Key Guide screen shows if **Eye Saver Mode** is enabled. (**Off, Low, High**)

When the product not displays the OSD menu, the  button could be used as below.

-  (UP): Adjust **Brightness, Contrast, Eye Saver Mode**.
-  (DOWN): Adjust **Volume, Mute**.
-  (LEFT/RIGHT): Adjust **Source**.
-  (PRESS(ENTER)): Display Function Key Guide.

S27H80*UA / S32H80*UA / S27H80*EF

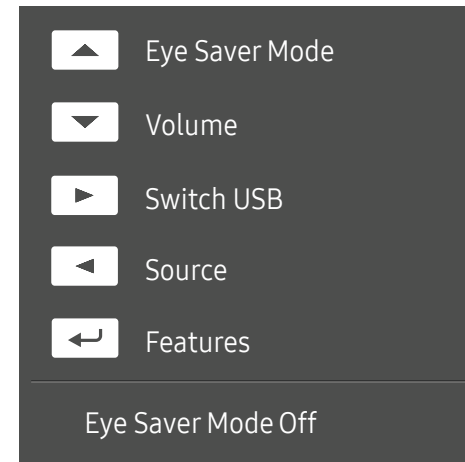



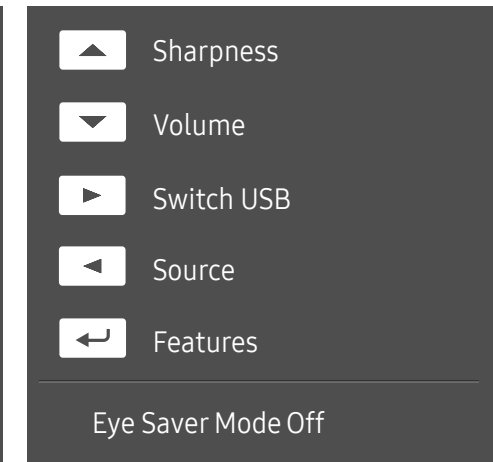

S40H85*T



The Direct Key Guide screen shows if **Eye Saver Mode** is enabled. (**Off, Low, High**)

When the product not displays the OSD menu, the 5-Way /  button could be used as below.

-  (UP):
 - Adjust **Brightness, Contrast, Eye Saver Mode**
(S27H80*UA / S32H80*UA / S27H80*EF)
 - Adjust **Brightness, Contrast, Sharpness**
(S40H85*T)
-  (DOWN): Adjust **Volume, Mute**.
-  (RIGHT): Switch the USB source.
-  (LEFT): Adjust **Source**.
-  (PRESS(ENTER)): Display Function Key Guide.

Ports

- The names, quantity, and locations of product may differ, depending on the model.
- The images shown below are for reference only and may differ from the colors and appearances of the actual product.

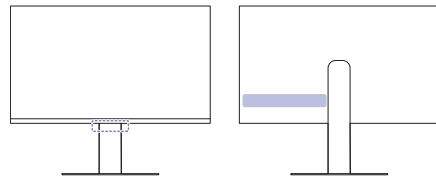

S27H70* / S32H70*



S27H80*EA / S32H80*EA

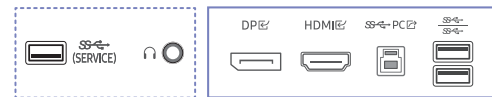

S27H80*UA / S32H80*UA

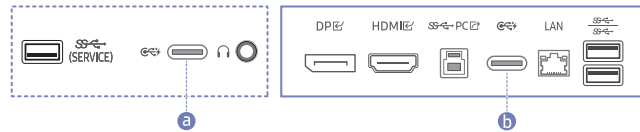



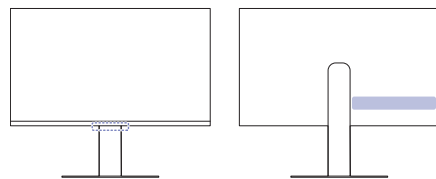
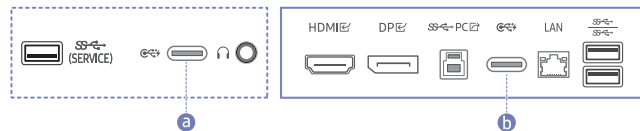









S27H80*EF



S40H85*T



Port	Description
DP	Connects to a PC using a DP cable.
HDMI	Connects to a source device using an HDMI cable.
	<p>Connect to a source device using a Thunderbolt™ 5 cable or USB Type-C cable.</p> <ul style="list-style-type: none"> • is Thunderbolt™ 5 upstream port. <ul style="list-style-type: none"> — With max 140 W PD output. — To connect to a PC via Thunderbolt, connect the cable to the port, one of the two USB Type-C ports.
	<p>Connect to a source device using a Thunderbolt™ 5 cable or USB Type-C cable.</p> <ul style="list-style-type: none"> • is Thunderbolt™ 5 downstream port. <ul style="list-style-type: none"> — With max 15 W PD output. — The port does not support the video input feature (DisplayPort ALT).
	<ul style="list-style-type: none"> Ⓐ: Connect to a USB device. <ul style="list-style-type: none"> — Compatible with a USB cable version 3.0. — A maximum of 15 W charging power is supported. — The USB Type-C port does not support the video input feature (DisplayPort ALT). Ⓑ: Connects to a source device using a USB Type-C cable. <ul style="list-style-type: none"> — Compatible with a USB cable version 3.0. — port can be connected to a notebook or mobile device for charging. — Charging some mobile devices through the USB Type-C port may not be supported depending on the mobile device specifications.

Port	Description
 (PC )	Connects to a PC using a USB Type-C cable. — This port can only connect to a PC.
 PC 	Connects to a PC using a USB Type-B cable. — This port can only connect to a PC.
LAN	<p>If you connect a LAN cable to this port, you can connect your computer, connected to the USB Type-C port  on the back of the monitor, to the network. — S27H80*UA / S32H80*UA / S27H80*EF models only.</p> <p>If you connect a LAN cable to this port, you can connect your computer, connected to the USB Type-C port (, ) on the back of the monitor, to the network. — S40H85*T model only. — Use Cat7(*STP Type) cable for the connection. (10/100 Mbps) *Shielded Twisted Pair</p>
	Connect to a USB device. — A maximum of 15 W charging power is supported.
 , 	Connect to a USB device.
 (SERVICE)	<ul style="list-style-type: none"> • Connect to a USB device. • Used to update the software.
SERVICE	Used to update the software.
	Connect to an audio output device such as headphones.
DC **V	Connects to the AC/DC adapter.
	Connect the power cord for product.

Installation

Attaching the Stand

- The color and shape of parts may differ from what is shown. Specifications are subject to change without notice to improve quality.
- Disassembly is the reverse order of assembly.

Components

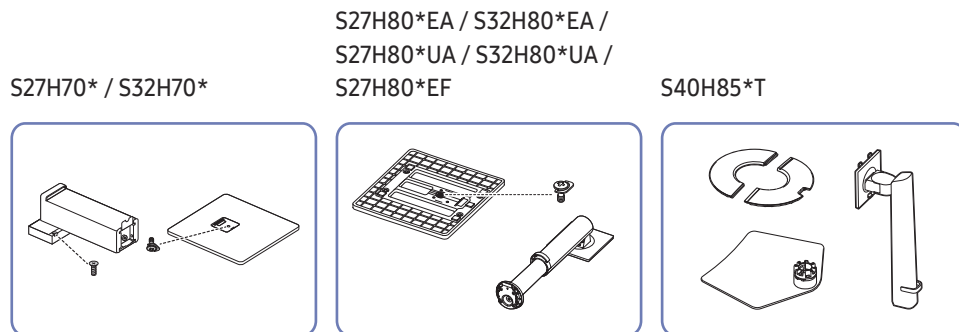

Instructions

S27H70* / S32H70*

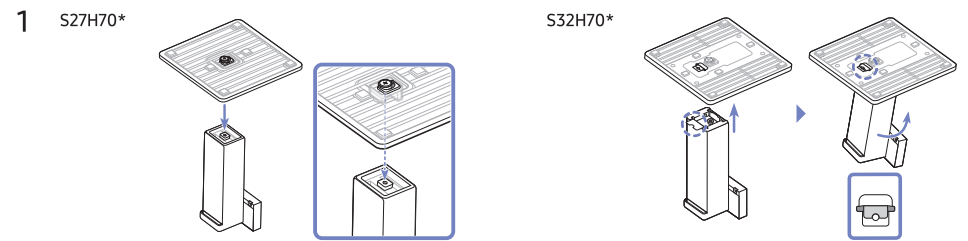

Put the stand base onto the stand neck as the direction shown in the figure. Check that the stand neck is firmly connected.

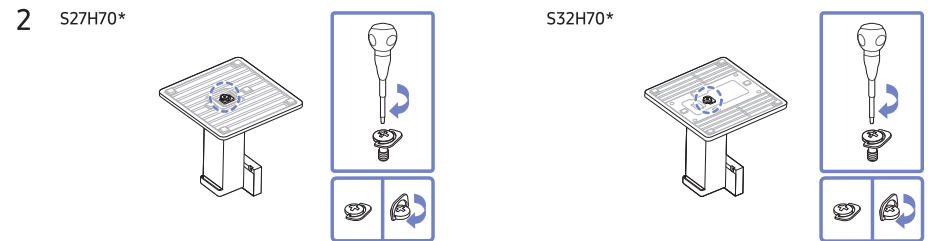

Tightly fasten the connecting screw at the bottom of the stand base.



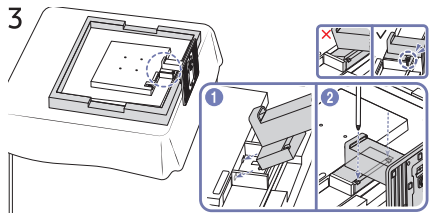

Place a soft cloth over the table to protect the product and place the product onto the cloth so that the front of the product is facing downwards. Push the assembled stand into the main body in the direction of the arrow as shown in the figure. Tightly fasten the connecting screw at the center of the stand neck.

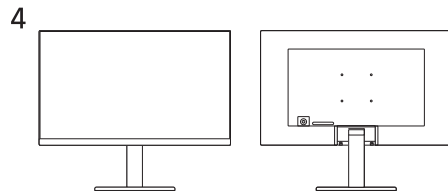

After installing the stand, place the product upright.

S27H80*EA / S32H80*EA / S27H80*UA / S32H80*UA / S27H80*EF

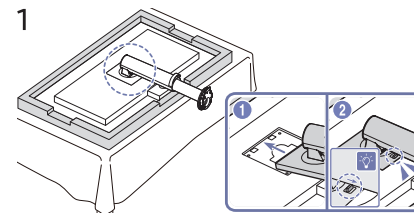

Push the stand neck into the main body in the direction of the arrow as shown in the figure. Check that the stand neck is firmly connected.

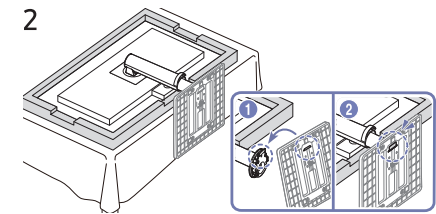

Insert the stand base into the stand neck in the direction as shown in the figure.

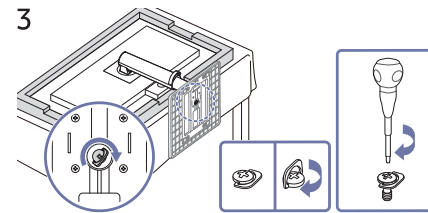

Tightly fasten the connecting screw at the bottom of the stand base.

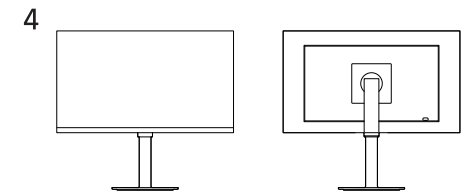

After installing the stand, place the product upright.

S40H85*T

1

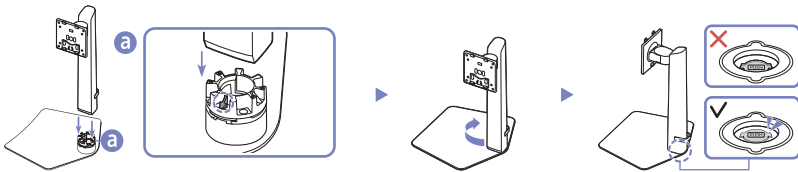

Check the direction of the arrow on the stand base. Align the direction of the arrow on the stand base with the front direction of the stand neck, and then insert the stand neck from top to bottom.

Turn the stand neck clockwise to fasten it to the base. Lift the stand slightly and check that the PUSH button on the bottom of the base protrudes.

2

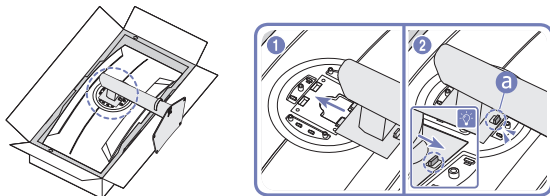

Push the assembled stand into the main body in the direction of the arrow as shown in the figure.

Confirm that the stand is tightly fastened. If **a** has not been fully lowered, lower it while holding it with your hand.

3

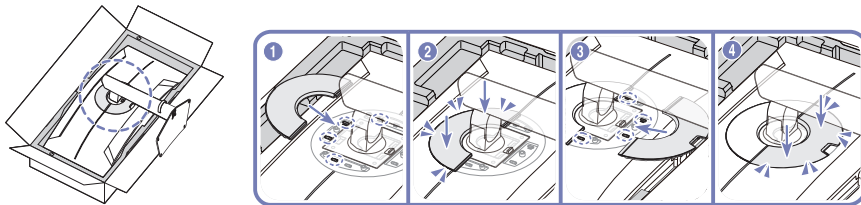

Attach the COVER-REAR TOP to the rear of the monitor, as shown in the figure.

4

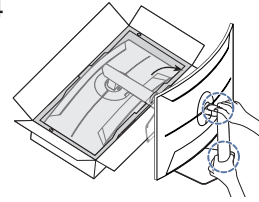

Stand up the monitor as shown in the figure.

5

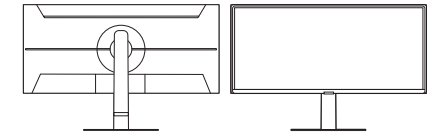

Stand assembly is complete.

Separating the stand neck from the stand base

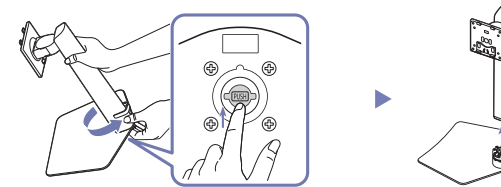

Lift the assembled stand slightly and press the PUSH button on the bottom of the base.

While holding down the PUSH button, turn the stand neck anticlockwise to remove it.

Precautions for moving the product

The color and shape of parts may differ from what is shown. Specifications are subject to change without notice to improve quality.

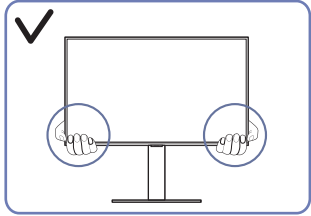

- Hold the lower corners or edges of the product when moving it.

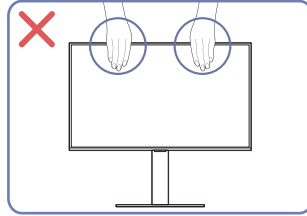

- Do not directly apply pressure on the screen.
- Do not hold the screen when moving the product.

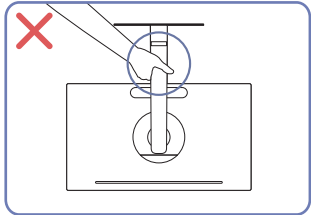

- Do not hold the product upside down only by the stand.

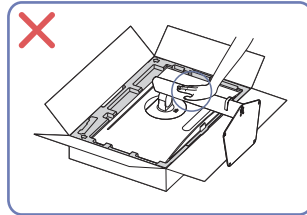

- Do not press down on the product. There is a risk of damaging the product.

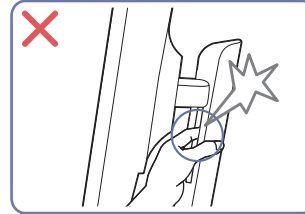

- Be careful not to get any body parts caught.

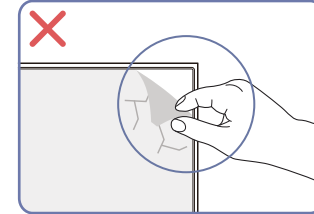

- Do not arbitrarily remove the panel film. If not observed, the warranty service may be restricted.

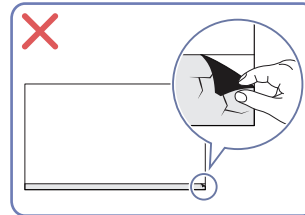

Checking the space around the product

Make sure to have enough space for ventilation when placing the product. An internal temperature rise may cause fire and damage the product. Maintain enough space around the product as shown in the diagram when installing the product.

— The exterior may differ depending on the product.

S27H70* / S32H70*

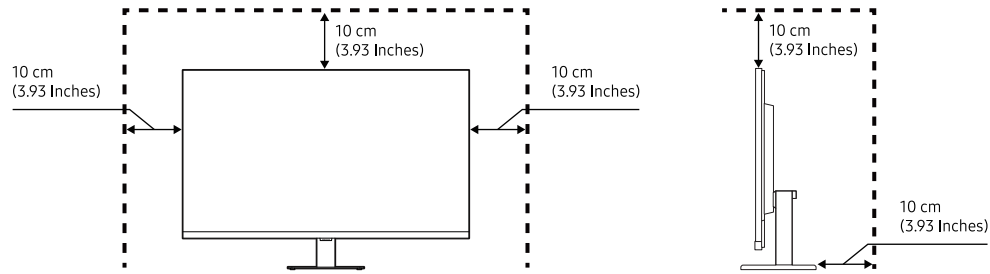

S27H80*EA / S32H80*EA / S27H80*UA / S32H80*UA / S27H80*EF

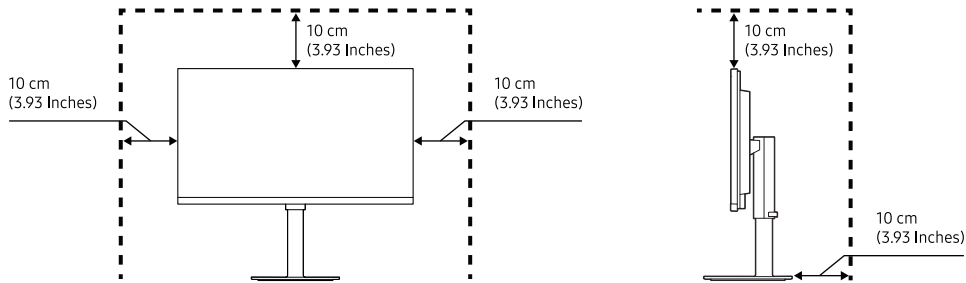

S40H85*T

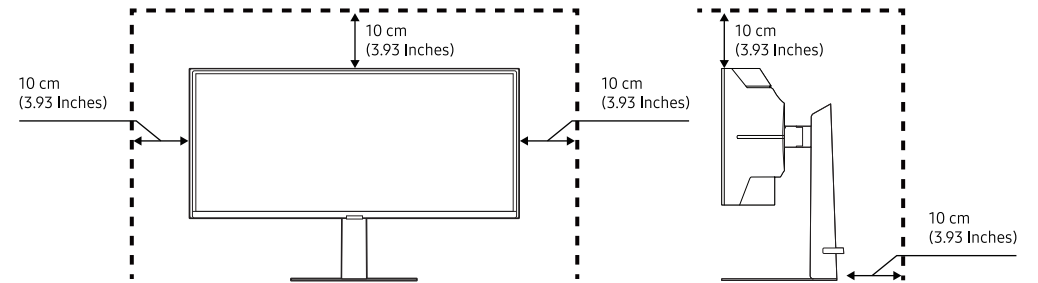

Adjusting the Product Tilt and Height

— The color and shape of parts may differ from what is shown. Specifications are subject to change without notice to improve quality.

S27H70* / S32H70*

$-2.0^{\circ} (+2.0^{\circ} / -3.0^{\circ}) \sim 15.0^{\circ} (\pm 2.0^{\circ})$

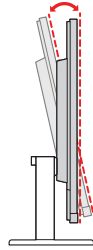

S27H80*EA / S32H80*EA / S27H80*UA / S32H80*UA / S27H80*EF

$-45.0^{\circ} (\pm 3.0^{\circ}) \sim 45.0^{\circ} (\pm 3.0^{\circ})$ $-3.0^{\circ} (\pm 2.0^{\circ}) \sim 25.0^{\circ} (\pm 2.0^{\circ})$ 120.0 mm (± 5.0 mm)

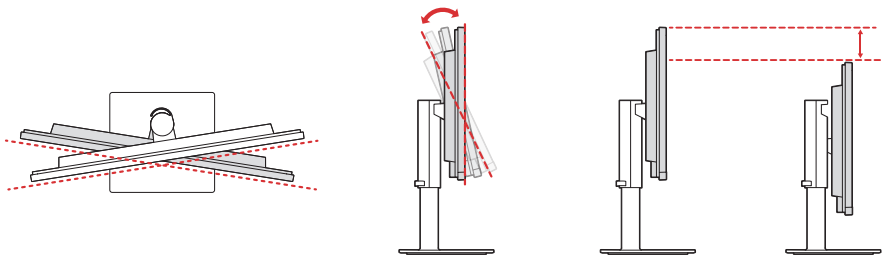

S40H85*T

$-20.0^{\circ} (\pm 3.0^{\circ}) \sim 20.0^{\circ} (\pm 3.0^{\circ})$

$-5.0^{\circ} (\pm 2.0^{\circ}) \sim 20.0^{\circ} (\pm 2.0^{\circ})$

120.0 mm (± 5.0 mm)

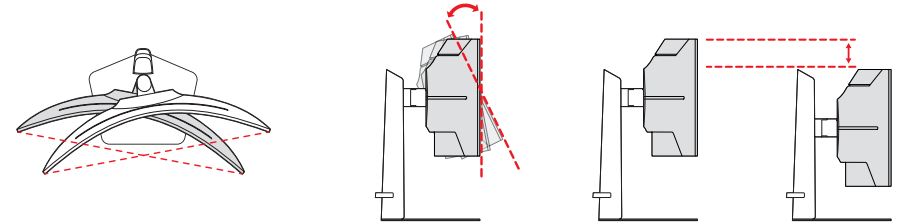

- The product tilt and height can be adjusted.
- Hold the top center of the product and adjust the height carefully.
- When adjusting the stand height, you may hear a noise. This noise is generated because the ball inside the stand slides when the stand height is adjusted. It is a normal noise and not a product malfunction.
- When adjusting the left/right angles of the product, there may be a slight gap in the connection area of the stand base. This is normal and does not indicate a malfunction of the product.

Caution

The color and shape of parts may differ from what is shown. Specifications are subject to change without notice to improve quality.

S27H70* / S32H70*

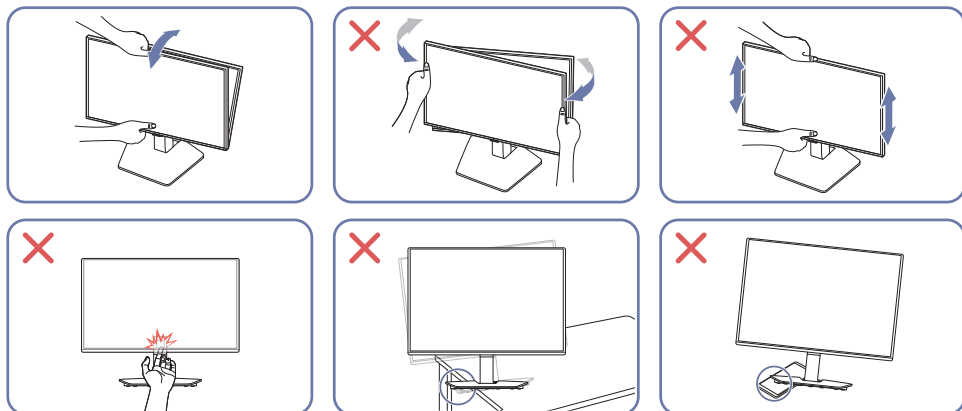

- Do not hold the moving area of the stand when adjusting the tilt or height of the product. It may cause injury.
- When installing the product on a cabinet or shelf, make sure that the bottom edge of the front of the product is not protruding.

S27H80*EA / S32H80*EA / S27H80*UA / S32H80*UA / S40H85*T / S27H80*EF

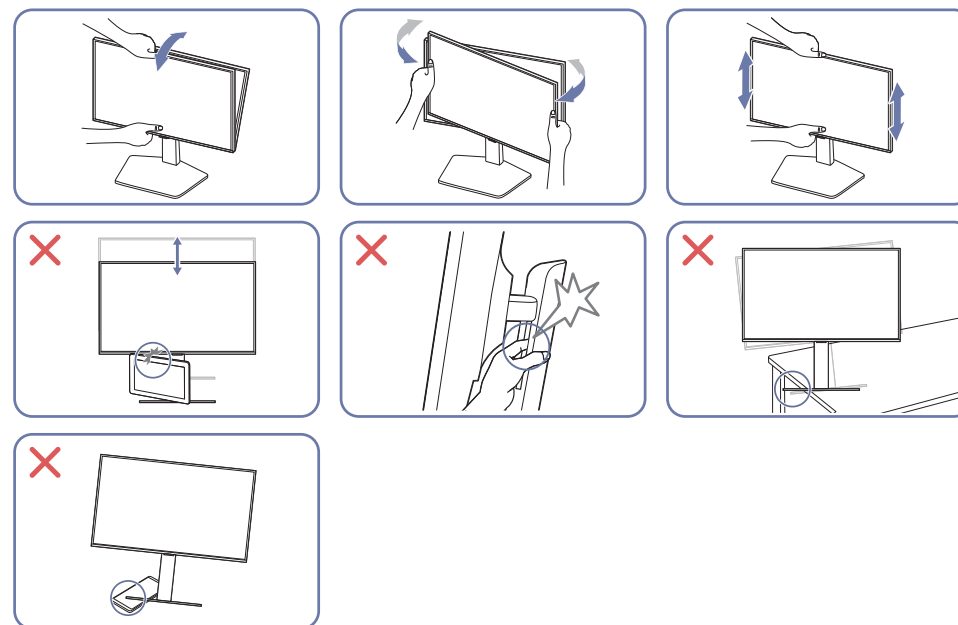

- Grasp the left and right sides of the monitor and adjust the swivel.
- Grasp the center of the monitor and adjust the height.
- Do not hold the moving area of the stand when adjusting the tilt or height of the product. It may cause injury.
- When installing the product on a cabinet or shelf, make sure that the bottom edge of the front of the product is not protruding.
- Do not put an object around the lower part of the product. The product or object may get damaged when adjusting the product height.

After adjusting the product tilt and height, if the screen is not level, take the following actions.

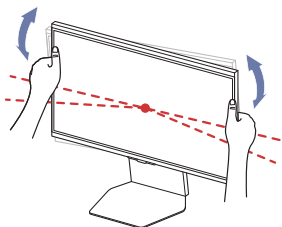

- Hold the bezel at both side edges and adjust the monitor angle until the screen becomes level. (Be careful not to directly hold the LCD display.)

Rotating the Product

- S40H85*T models are not supported.
- The color and shape of parts may differ from what is shown. Specifications are subject to change without notice to improve quality.

S27H70* / S32H70*

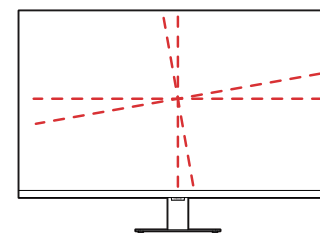

-3.0° (±2.0°) ~ 3.0° (±2.0°)

S27H80*EA / S32H80*EA / S27H80*UA / S32H80*UA / S27H80*EF

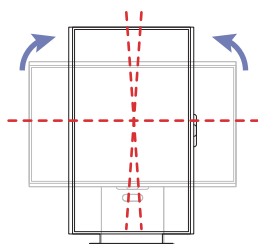
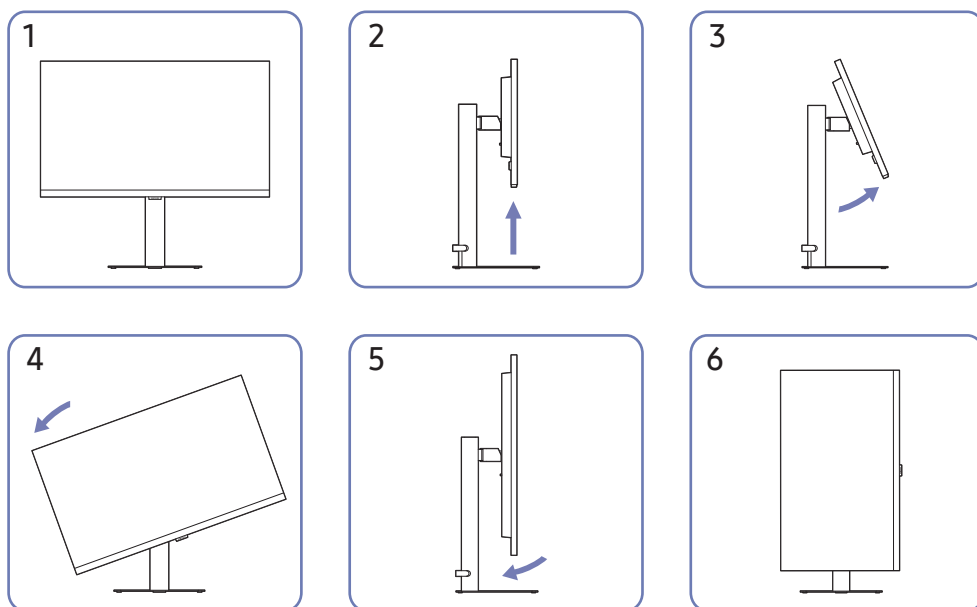

-92.0° (±2.0°) ~ 92.0° (±2.0°)

- Be sure to fully extend the stand before rotating the product.
- If you rotate the product without fully extending the stand, the corner of the product may hit the floor and get damaged.
- When rotating the product, be careful not to damage the product by hitting the object or stand.

Anti-theft Lock

- An anti-theft lock allows you to use the product securely even in public places.
- The locking device shape and locking method depend on the manufacturer. Refer to the manuals provided with your anti-theft locking device for details.

To lock an anti-theft locking device:

S27H70* / S32H70*
S27H80*EA / S32H80*EA
S27H80*UA / S32H80*UA
S27H80*EF

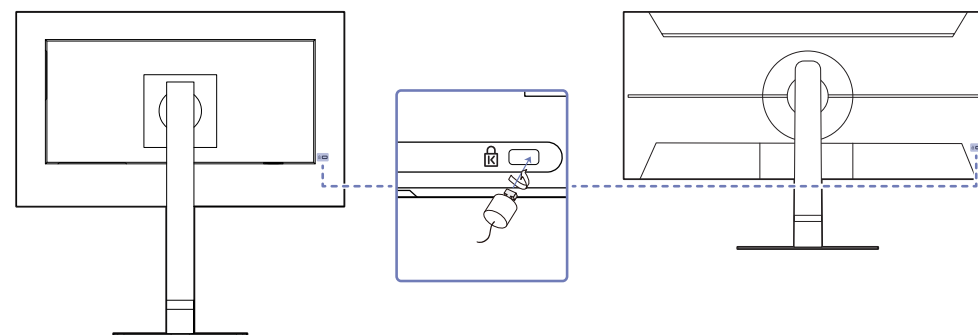

- 1 Fix the cable of your anti-theft locking device to a heavy object such as a desk.
- 2 Put one end of the cable through the loop on the other end.
- 3 Insert the locking device into the anti-theft lock slot at the back of the product.
- 4 Lock the locking device.
 - An anti-theft locking device can be purchased separately.
 - Refer to the manuals provided with your anti-theft locking device for details.
 - Anti-theft locking devices can be purchased at electronics retailers or online.

Wall Mount Kit Specifications (VESA)

— Install your wall mount on a solid wall perpendicular to the floor. Before attaching the wall mount to surfaces other than plaster board, please contact your nearest dealer for additional information. If you install the product on a slanted wall, it may fall and result in severe personal injury. Samsung wall mount kits contain a detailed installation manual and all parts necessary for assembly are provided.

- Do not use screws that are longer than the standard length or do not comply with the VESA standard screw specifications. Screws that are too long may cause damage to the inside of the product.
- When installing the wall mount other than the specified product, its installation may be difficult.
- For wall mounts that do not comply with the VESA standard screw specifications, the length of the screws may differ depending on the wall mount specifications.
- Do not fasten the screws too firmly. This may damage the product or cause the product to fall, leading to personal injury. Samsung is not liable for these kinds of accidents.
- Samsung is not liable for product damage or personal injury when a non-VESA or non-specified wall mount is used or the consumer fails to follow the product installation instructions.
- Do not mount the product at more than a 15 degree tilt.
- Use the power cable provided with the monitor. (The power input connector on the monitor is 'L' shaped.)
- To install the monitor on a stand, use the supplied stand.
To use on a personally purchased mounting device (e.g. a monitor arm, stand, or wall mount), install the cables with sufficient slack to allow the monitor to tilt or rotate.
If a cable is pulled or squeezed, the input connector may be damaged, and any damage resulting from this is not covered under warranty.
- Standard dimensions for wall mount kits are shown in the table follow.

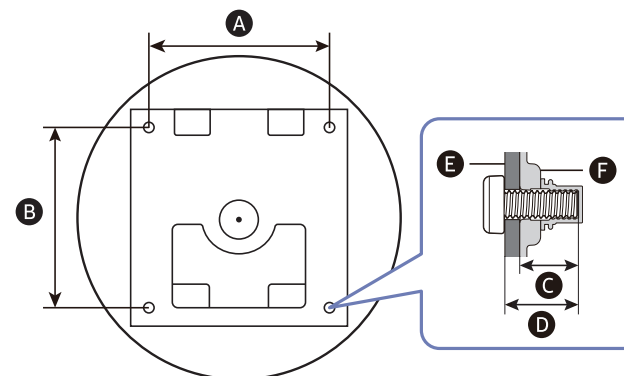

Ⓔ : Wall mount bracket

Ⓕ : Product

Model name	VESA screw hole specs (Ⓐ * Ⓑ) in millimeters	Ⓒ	Ⓓ	Standard Screw	Quantity
S27H70* S32H70* S27H80*EA S32H80*EA S27H80*UA S32H80*UA S40H85*T S27H80*EF	100.0 x 100.0	6.0 ~ 8.0 mm	Ⓒ + Ⓔ	M4	4

— Do not install your Wall Mount Kit while your product is turned on. It may result in personal injury due to electric shock.

Installing the Software

Samsung Display Manager

Samsung Display Manager is an integrated monitor control program.

To install the latest version of **Samsung Display Manager**, download it from the Samsung website(<http://www.samsung.com>) or the Microsoft Store.

- The Samsung Display Manager icon may not appear depending on the PC system and the product specifications.
- If the shortcut icon does not appear, press the F5 key.

Restrictions and Problems with the Installation

The Samsung Display Manager installation may be affected by the Graphics Card, Motherboard and the Networking Environment.

Driver Installation

To install the latest version of the product driver, download it from the Samsung website.

(<http://www.samsung.com>)

- You can set the optimum resolution and frequency for this product by installing the corresponding drivers.

Connections

Read below before connecting the product.

- 1 Before connecting the product, check the shapes of both ports of the supplied signal cables and the shapes and locations of the ports on the product and external device.
- 2 Before connecting the product, make sure you remove the power cords from both the product and the external device to prevent damage to the product due to a short circuit or over current.
- 3 After all signal cables have been properly connected, connect the power cords back to the product and the external device.
- 4 After connecting is completed, make sure you read the manuals to acquaint yourself with the product functions, precautions and other information required to use the product properly.
- 5 To use Max specifications of our products, check the support specifications of the cable version you use.

— Connecting parts may differ in different products.

— Provided ports may vary depending on the product.

Connecting and Using a PC

Select a connection method suitable for your PC.

Connection Using the HDMI Cable

HDMI 



— It is recommended to use the HDMI cable provided as components. If not provided, be sure to use authorized cable for HDMI cable connections. If you use an unauthorized HDMI cable, the image quality may be degraded.

Connection Using an DP Cable



- It is recommended to use the DP cable provided as an accessory. If not provided, be sure to use a DP cable of 1.5 m or below.
- Use a VESA certified DP1.2 cable or higher and its gender.

Connecting to headphones or earphones



- Use headphones or earphones when activating sound with an HDMI-HDMI or DP cable.
- The headphones or earphones jack supports only the 3 conductor tip-ring-sleeve (TRS) type.

Connecting the Power

S27H80*EA / S32H80*EA / S27H80*UA / S32H80*UA / S40H85*T / S27H80*EF

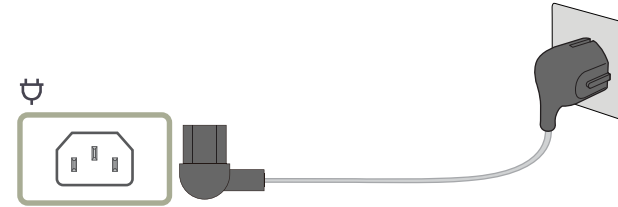

- To use the product, connect the power cord to a power outlet and the ⏏ port on the product.
- The input voltage is switched automatically.
 - The orientation and shape of the image may vary depending on the model.

— The images shown below are for reference only and may differ from the colors and appearances of the actual product components.

S27H70* / S32H70*

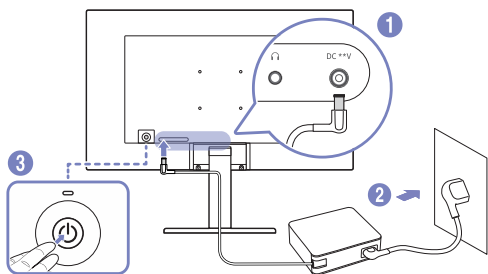

- 1 Connect the power cord to the AC/DC adapter. Then, connect the AC/DC adapter to the DC **V port on the back of the product.
 - Rated power consumption for adapters differs depending on the model. Use an adapter that meets the power consumption specification of the model.
 - 2 Next, connect the power cord to the power outlet.
 - 3 Press the  button of the product to turn it on.
- The input voltage is switched automatically.

Connection Using the USB Type-C Cable

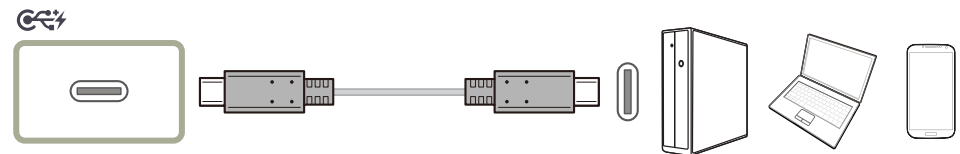

- This function is supported on the S27H80*UA / S32H80*UA / S27H80*EF model only.
- Check the bandwidth of your USB Type-C cable whether it is available. The output may not be adequate depending on the cable specification and condition.
- Do not quickly connect or disconnect the connector and power cable, because it requires some time.
- Due to the compatibility issue, the function may not be available when any Thunderbolt device is connected using a cable.
- When charging with a USB Type-C cable, malfunction may occur depending on the device type. In this case, use the provided charger or consult the manufacturer of the device.

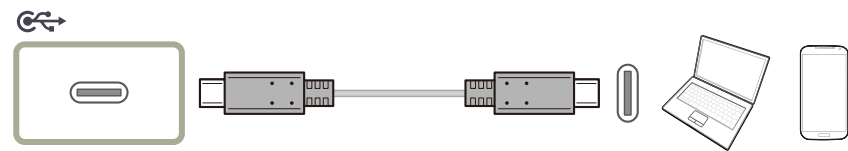

The USB Type-C port can be connected to a notebook or mobile device for charging.

- This function is supported on the S40H85*T model only.
- We cannot guarantee that this product can charge all types of devices that have a USB Type-C port, because there are a wide variety of devices that come with USB Type-C ports on the market.
- Make sure your USB Type-C cable complies with the USB Power Delivery specification. A cable that does not comply with the specification may damage the device.

Connection Using a Thunderbolt™ 5 Cable or USB Type-C Cable

S40H85*T

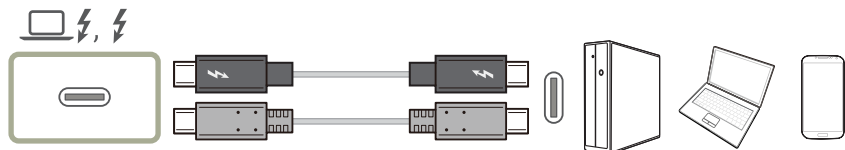

According to the USB Power Delivery 3.0 specification, our product can charge your PC when you connect it to our product using a Thunderbolt™ 5 cable or USB Type-C cable.

To get the full experience of the Thunderbolt™ 5 technology, connect a PC that supports this technology using a Thunderbolt™ 5 cable and ensure that all connected devices and cables are approved by Intel Thunderbolt. For detailed approval information, visit the official Intel website.

Before using the product, update the BIOS program, Thunderbolt firmware, and Thunderbolt software of your PC to their latest versions by visiting the official website of your PC.

- If you want to charge your PC, make sure that your PC supports power input. Many Thunderbolt™ 5 -compatible PCs do not support charging over a USB Type-C port, and some PCs can charge only their own branded power adapters. Because PC released in the market are very various, we cannot guarantee that our product can charge all types of PC over a Thunderbolt™ 5 port.
- Unlike USB devices, Thunderbolt™ 5 devices must be manually authenticated through Intel's Thunderbolt program before the system recognizes them.
- Considering that it takes a relatively long time to complete the connection and disconnection over Thunderbolt, do not quickly plug in and unplug the signal cable or power cable. Otherwise, your devices may be damaged.
- When connecting an external device that exceeds the charging capacity of the Thunderbolt™ 5/USB-C port, be sure to use the adapter dedicated to the device. (For charging capacities for each port, see the product specifications in the Samsung website (<http://www.samsung.com>). Ensure that the latest version of MacOS is installed on your Mac device.
- Display may not work properly depending on the Intel processor and Windows OS version. (Minimum requirements: Intel 12th Gen or later, Windows 11 or later.)
- Display may not work properly on non-Apple Silicon devices depending on the macOS version. (Minimum requirements: macOS Sequoia (version 15) or later)
- When connecting a notebook or laptop computer, connect the cable to the  port on the monitor.
- Make sure that the Thunderbolt™ 5 or USB Type-C cable complies with the Thunderbolt™ 5 or USB Type-C specification. Otherwise, your devices may be damaged. A Samsung branded cable is recommended.
- Because of compatibility with the Thunderbolt technology, phones that support the USB Type-C display may not be displayed on our product. To fix this problem, you may need to upgrade the firmware from your phone's manufacturer.
- Connect the Thunderbolt™ 5 cable to a PC that supports Thunderbolt™ 5 and connect the USB Type-C cable to a PC that supports USB Type-C.

Connecting the Dual display (daisy chain)

S40H85*T

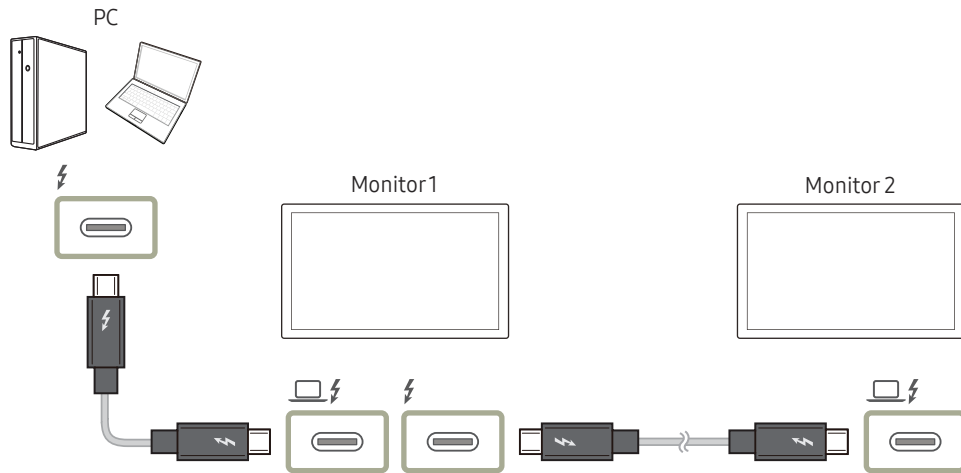

Dual display (daisy chain) support depends on your PC and the connected Thunderbolt™ 5 cable. The Thunderbolt™ 5 port on your PC must support dual 4 K @ 60 Hz output, and the particular 40Gbps Thunderbolt™ 5 cable need to be purchased separately. For detailed specification of the Thunderbolt™ 5 cable, visit the official Thunderbolt website.

— The supplied Thunderbolt™ cable supports up to 80 Gbps.

Connecting the Product to a PC as a USB HUB

Using the product as a hub, connect and use various source devices with the product at a time.

— S27H70* / S32H70* models are not supported.

— Port names and the number of ports may differ, depending on the model.

S27H80*EA / S32H80*EA

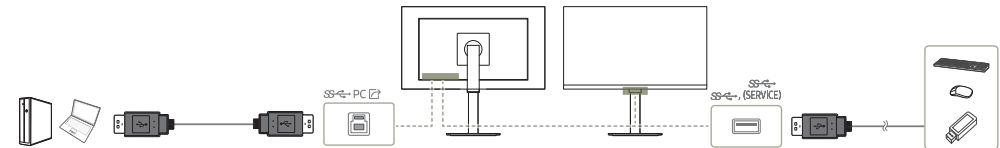

S27H80*UA / S32H80*UA / S27H80*EF

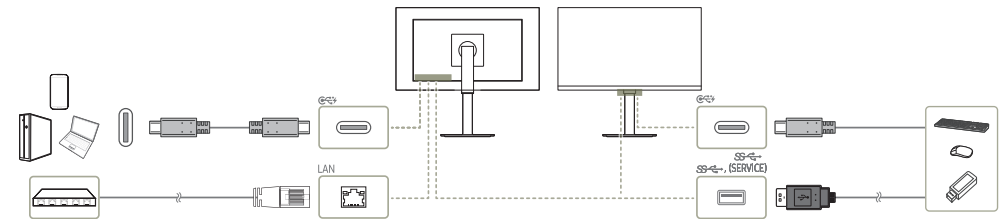

S40H85*T

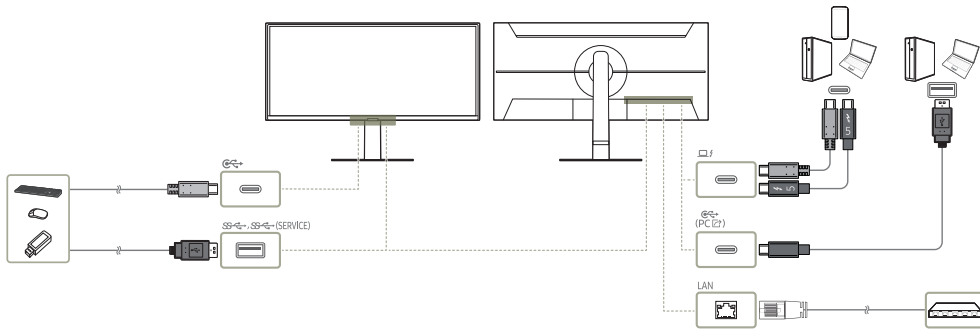

Use the product as a hub to connect the PC to a variety of devices or networks.

— Network connection through LAN is supported. (S27H80*UA / S32H80*UA / S27H80*EF / S40H85*T models only)

— With some PCs, network connection through LAN may not be supported.

Using the product as a hub, connect and use various source devices with the product at a time.

— To detect and start a USB device faster, connect the USB device to the (SERVICE), port on the product. The read/ write rate will be affected by the USB device and your PC.

— For USB-related problems caused by OS, drive programs or software, please contact relevant suppliers.

— With the launch of various USB devices on the market, we cannot guarantee that our products are matched with all USB devices.

— For an external mass-storage HDD requiring external power supply, be sure to connect it to a power source.

— The company is not liable for problems or damages to an external device caused by using an unauthorized cable for the connection.

— Some products do not follow the USB standard, and it may cause a malfunction of the device.

— Charging some mobile devices through the USB Type-C port may not be supported depending on the mobile device specifications.

Tidying Up the Cables

— The images shown below are for reference only and may differ from the colors and appearances of the actual product components.

S27H70* / S32H70* / S27H80*EA / S32H80*EA / S27H80*UA / S32H80*UA / S27H80*EF

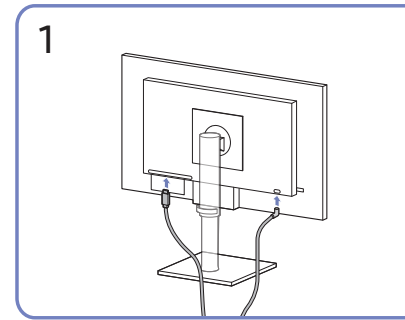

1
Connect the corresponding cables.

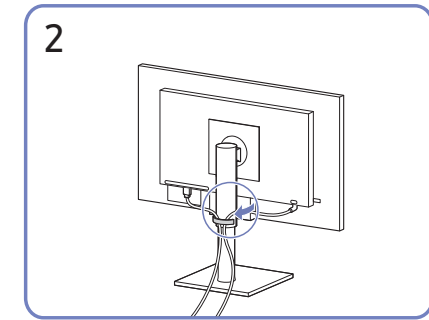

2
Put both cables in the cable holder on the stand (HOLDER-STAND CABLE) to organize the cables, as shown in the figure.

Assembly is complete.

S40H85*T

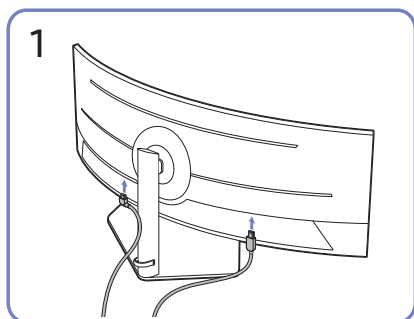

Connect the corresponding cables.

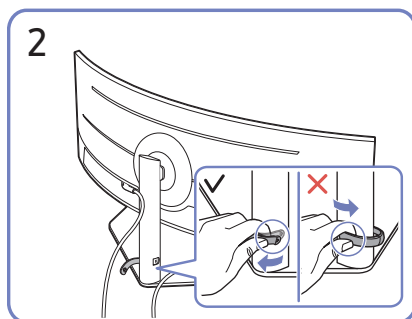

Pull the right side of the HOLDER-STAND CABLE to remove from the stand. The left side of the HOLDER-STAND CABLE can be damaged when pulled forcibly.

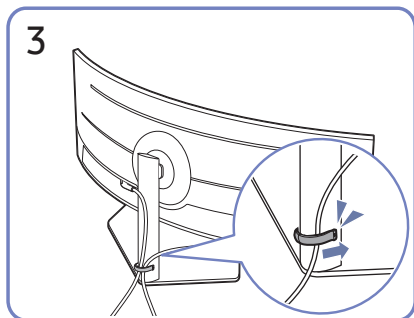

Put both cables in the cable holder on the stand (HOLDER-STAND CABLE) to organize the cables, as shown in the figure.

Assembly is complete.

Setting Optimum Resolution

An information message about setting optimum resolution will appear if you power on the product for the first time after purchase.

Select a language on information message and change the resolution on your PC to the optimum setting.

- If the optimum resolution is not selected, the message will appear up to three times for a specified time even when the product is turned off and on again.
- To set the Optimum resolution, go to **OS** → **System** → **Input Port Ver./DisplayPort Ver.** and set HDMI/DP to the maximum version.

Configuring Menu Settings

Function Key Guide → 

— The functions available may vary depending on the product model. The color and shape of parts may differ from what is shown. Specifications are subject to change without notice to improve quality.

Picture

2nd	Description
Picture Mode	<p>This menu provides an optimum picture quality suitable for the environment where the product will be used.</p> <p>— This menu is not available when Eye Saver Mode is enabled.</p> <p>In PC mode</p> <ul style="list-style-type: none">• Entertain: Obtain the clear and vivid picture quality with color enhancement.• Graphic: Obtain the quality of Image contents without color enhancement.• Eco: This screen is provided to save energy.• Game Standard: Obtain a picture quality suitable for playing games.

2nd	Description
Picture Mode	<ul style="list-style-type: none">• RPG: This mode is optimized for 3D graphics and instant messaging on the RPG (Role Playing Game) game screen.• RTS: Increase the color temperature and contrast ratio to improve visibility of the RTS (Real-Time Strategy) screen and minimap.• FPS: Increase the brightness of darker areas of the FPS (First-Person Shooter) game screen. This mode increases visibility of your enemies during a FPS (First-Person Shooter) game.• Sports: Obtain the brightness and sharpness of monitors suitable for enjoying sports contents.• Original: Obtain the pure picture quality of contents without color enhancement.• Custom: Customize the contrast and brightness as required.

2nd	Description
Picture Mode	<p>In AV mode</p> <p>When the external input is connected through HDMI/DP/USB Type-C and PC/AV Mode is set to AV, Picture Mode has eleven automatic picture settings (Dynamic, Standard, Eco, Movie, Game Standard, FPS, RTS, RPG, Sports, Original and Custom) that are preset at the factory. You can activate either Dynamic, Standard, Eco, Movie, Game Standard, FPS, RTS, RPG, Sports, Original or Custom. You can select Custom which automatically recalls your personalized picture settings.</p> <ul style="list-style-type: none"> • Dynamic: Select this mode to view a sharper image than in Standard mode. • Standard: Select this mode when the surroundings are bright. • Eco: This screen is provided to save energy. • Movie: Select this mode when the surroundings are dark. This will save power and reduce eye fatigue. • Game Standard: Obtain a picture quality suitable for playing games. • RPG: This mode is optimized for 3D graphics and instant messaging on the RPG (Role Playing Game) game screen.

2nd	Description
Picture Mode	<ul style="list-style-type: none"> • RTS: Increase the color temperature and contrast ratio to improve visibility of the RTS (Real-Time Strategy) screen and minimap. • FPS: Increase the brightness of darker areas of the FPS (First-Person Shooter) game screen. This mode increases visibility of your enemies during a FPS (First-Person Shooter) game. • Sports: Obtain the brightness and sharpness of monitors suitable for enjoying sports contents. • Original: Obtain the pure picture quality of contents without color enhancement. • Custom: Select this mode when you want to adjust the image according to your preferences. <ul style="list-style-type: none"> — This function may not be supported depending on the model. — The input source is 480p, 576p, 720p or 1080p and product can display normally (Not every model can support all of these signals.).



2nd	Description
Brightness	<p>You can adjust the general brightness of the picture. (Range: 0~50)</p> <p>A higher value will make the picture appear brighter.</p> <p>— This menu is not available when Eye Saver Mode is enabled.</p>
Contrast	<p>Adjust the contrast between the objects and background. (Range: 0~50)</p> <p>A higher value will increase the contrast to make the object appear clearer.</p>
Sharpness	<p>Make the outline of objects more clear or blurry. (Range: 0~20)</p> <p>A higher value will make the outline of objects clearer.</p>
Color	<p>Adjust the color saturation levels. Color saturation intensifies as the value nears 50.</p> <p>— This menu is not available when Eye Saver Mode is enabled.</p>
Tint (G/R)	<p>Adjust the ratio of green to red tint levels. Increasing values intensifies the saturation of red and green colors.</p> <p>— This menu is not available when Eye Saver Mode is enabled.</p>
Contrast Enhancer	<p>Automatically balance the contrast to prevent excessive differences between bright and dark areas.</p> <ul style="list-style-type: none"> • Off / Low / High <p>— This menu is not available when Eye Saver Mode is enabled.</p>

2nd	Description
HDR Tone Mapping	<p>Automatically adjusts the brightness with tone mapping processing according to HDR content information.</p> <p>— This menu is not available when Eye Saver Mode is enabled.</p>
Color Tone	<p>Select a color tone that best suits your viewing needs.</p> <p>— This menu is not available when Eye Saver Mode is enabled.</p>
White Balance	<p>Adjust the color temperature of the picture so that white objects appear brighter.</p> <p>— This menu is not available when Eye Saver Mode is enabled.</p>
Red	<p>Adjust the red saturation level. Values closer to 50 mean greater intensity for the color.</p>
Green	<p>Adjust the green saturation level. Values closer to 50 mean greater intensity for the color.</p>
Blue	<p>Adjust the blue saturation level. Values closer to 50 mean greater intensity for the color.</p>
Reset	<p>Restore the white balance settings to the default values.</p>

2nd	Description
Gamma	Adjust the middle level of luminance. ─ This menu is not available when Eye Saver Mode is enabled.
Shadow Detail	Adjust the brightness of dark images. Black detail increases as the value nears 5. ─ This menu is not available when Eye Saver Mode is enabled.
Color Space	Configure color space settings to refine the spectrum of colors on your screen. ─ This menu is not available when Eye Saver Mode is enabled.
Dynamic Brightness	Automatically adjust the Brightness to provide the best possible screen contrast under the current conditions. ─ This menu is not available when Eye Saver Mode is enabled.
Black Level	Optimize HDMI picture brightness and contrast by adjusting the black level of the video signal. In such case, Black Level can be used to adjust the image quality. <ul style="list-style-type: none"> • Auto / Normal / Low ─ This function is only available in HDMI mode. ─ Black Level may not be compatible with some source devices. ─ The Black Level feature is only activated at a certain AV resolution, such as 480p @ 60 Hz, 576p @ 50 Hz, 720p @ 60 Hz and 1080p @ 60 Hz. ─ This menu is not available when Eye Saver Mode is enabled.

2nd	Description
Eye Saver Mode	Set to an optimum picture quality suitable for eye relaxation. When Eye Saver Mode is 'On', the blue light that wavelength is around 400nm will decrease, and it will provide an optimum picture quality suitable for eye relaxation. ─ S27H70* / S32H70* / S27H80*EA / S32H80*EA / S27H80*UA / S32H80*UA / S27H80*EF models only.
Response Time	Accelerate the panel response rate to make video appear more vivid and natural. ─ Use Standard mode when not playing a video or game.
Screen Ratio	Choose the size and aspect ratio of the picture displayed on screen. In PC mode <ul style="list-style-type: none"> • Auto / Wide In AV mode <ul style="list-style-type: none"> • 4:3 / 16:9 / 21:9 / Screen Fit ─ The 21:9 menu is supported on the S40H85*T model only. ─ The function may not be supported depending on the ports provided with the product. ─ Changing the Screen Ratio is available when the following conditions are satisfied. <ul style="list-style-type: none"> ─ The input source is 480p, 576p, 720p or 1080p and product can display normally (Not every model can support all of these signals.). ─ This can only be set when the external input is connected through HDMI/DP/USB Type-C and PC/AV Mode is set to AV.













2nd	Description
Screen Adjustment	<p>Adjust the position of the screen or increase the picture quality.</p> <ul style="list-style-type: none"> • H-Position: Move the screen to the left or right. • V-Position: Move the screen up or down. <p>— Connection Using the HDMI, DP, USB Type-C Cable</p> <p>— This menu is only available when Screen Ratio is set to Screen Fit in AV Mode.</p> <p>When a 480p, 576p, 720p or 1080p signal is input in AV mode and the product can display normally, select Screen Fit to adjust horizontal position and vertical position in 0-6 levels.</p>
Calibration Report	<p>View the Calibration Report.</p> <p>— S40H85*T models only.</p>
Picture Reset	<p>Restore all picture settings to the factory default.</p>





Eye Care

— S40H85*T models only.

2nd	Description
Adaptive Picture	<p>Optimizes brightness and provides the best picture quality in real time, based on the lighting condition and the content you're viewing.</p> <p>— This menu is not available when Best Brightness is enabled.</p>
Minimum Brightness	<p>Set the minimum brightness for the monitor screen. This function only works if its value is lower than the value set in the Picture menu's Backlight setting.</p>
Eye Saver Mode	<p>Set to an optimum picture quality suitable for eye relaxation.</p> <p>When Eye Saver Mode is 'On', the blue light that wavelength is around 400nm will decrease, and it will provide an optimum picture quality suitable for eye relaxation.</p>

PIP/PBP

2nd	Description
PIP/PBP Mode	Turn PIP/PBP Mode on or off.
Mode Type	Select the size and aspect ratio of the sub-screen. <ul style="list-style-type: none">  8:9  8:9 /  PIP  /  <p><small>— S40H85*T models only.</small></p>
Screen Size	Select sub-screen size. <ul style="list-style-type: none">  /  /  <p><small>— This option is available when Mode Type is set to PIP.</small></p>
Screen Position	Select the position of the sub-screen from the available options. <ul style="list-style-type: none">  /  /  /  <p><small>— This option is available when Mode Type is set to PIP.</small></p>
Source	Select the source for each screen.



2nd	Description
Sound Source	Set which screen you want to hear the sound for. <p>In PIP mode</p> <ul style="list-style-type: none">  /  <p>In PBP mode</p> <ul style="list-style-type: none">  / 
Switch USB	Switch the USB source while in the PIP/PBP mode. <p><small>— S27H80*UA / S32H80*UA / S40H85*T / S27H80*EF models only.</small></p>
Screen Ratio	Choose the size and aspect ratio of the picture displayed on screen. <p>In PC mode</p> <ul style="list-style-type: none"> Auto / Wide <p>In AV mode</p> <ul style="list-style-type: none"> 4:3 / 16:9 / 21:9 / Screen Fit <p><small>— The 21:9 menu is supported on the S40H85*T model only.</small></p> <p><small>— The function may not be supported depending on the ports provided with the product.</small></p> <p><small>— Changing the Screen Ratio is available when the following conditions are satisfied.</small></p> <ul style="list-style-type: none"> <small>— The input source is 480p, 576p, 720p or 1080p and product can display normally (Not every model can support all of these signals.).</small> <small>— This can only be set when the external input is connected through HDMI/DP/USB Type-C and PC/AV Mode is set to AV.</small>

OnScreen Display

2nd	Description
Transparency	Set the transparency for the menu windows.
Position	<ul style="list-style-type: none">• H-Position: Move the menu position to the left or right.• V-Position: Move the menu position up or down.
Language	Set the menu language. — A change to the language setting will only be applied to the onscreen menu display.
Display Time	Set how long the menu window will remain on screen for when it is not in use.
Display Time Info	Show the time left until the menu window disappears. Menu display time can be set in the Menu settings. — S27H70* / S32H70* / S27H80*EA / S32H80*EA / S27H80*UA / S32H80*UA / S27H80*EF models only.
Enlarge	Enlarge the size of the Menu area. — S27H70* / S32H70* / S27H80*EA / S32H80*EA / S27H80*UA / S32H80*UA / S27H80*EF models only.

System

2nd	Description
SeeColors Mode	Allows users with color blindness to experience rich colors. Enable this feature to customize colors to suit your viewing conditions, to experience richer colors on the screen. — Some menus are not available when SeeColors Mode is in use. — This function may not be supported depending on the model. — S40H85*T models only.
Adaptive-Sync	Adaptive-Sync technology is solution that eliminates screen tearing without all the usual lag and latency. — This option is not available when DP version 1.1 or HDMI version 1.4. — S40H85*T models only.
FreeSync Premium	FreeSync technology is solution that eliminates screen tearing without all the usual lag and latency. FreeSync can be operated when you use AMD's graphic card with supporting FreeSync solution. For more information, see FreeSync (for AMD graphics card) page. — This option is not available when DP version 1.1 or HDMI version 1.4. — The names and positions of OSD menu items may differ, depending on the model. — S40H85*T models only.

2nd	Description
Save Energy	Reduce power consumption by adjusting brightness settings.
 Volume	Change the Volume setting.
USB Source Setup	Set up a USB port assigned to the video source. <small>— S27H80*UA / S32H80*UA / S40H85*T / S27H80*EF models only.</small>
Off Timer Plus	<p>Off Timer</p> <ul style="list-style-type: none"> • Off Timer: Turn on Off Timer mode. • Turn Off After: The off timer can be set within a range of 1 to 23 hours. The product will automatically power off after the specified number of hours. <ul style="list-style-type: none"> – This option is only available when Off Timer is set to On. <p><small>— For products for the market in some regions, the Off Timer is set to automatically activate 4 hours after the product powers on. This is done in accordance with power supply regulations. If you do not want the timer to activate, go to  → System → Off Timer Plus and set Off Timer to Off.</small></p> <p>Eco Timer</p> <ul style="list-style-type: none"> • Eco Timer: Turn on Eco Timer mode. • Eco Off After: The Eco Timer can be set between 10 and 180 minutes. The product will automatically power off after the specified time has elapsed. <ul style="list-style-type: none"> – This option is only available when Eco Timer is set to On.

2nd	Description
PC/AV Mode	Set PC/AV Mode to AV . The picture size will be enlarged. This option is useful when you view a movie. <small>— Products with a display area of 16:9 or 16:10 are only supported.</small>
DisplayPort Ver.	Select the DisplayPort version to use. <small>— Incorrect settings may cause the screen to go blank. If this occurs, check the device specifications.</small>
Input Port Ver.	Select an HDMI version. <small>— The supportable device and resolution may differ depending on its version.</small> <small>— When the version is changed, the screen may blink.</small> <small>— If you set the HDMI Mode to 1.4, some high resolutions may not be supported because of bandwidth limitation of the HDMI 1.4 protocol.</small> <small>— When the setting is not appropriate, a blank screen may appear. In this case, check the specifications of the device.</small>
Auto Source Switch+	<p>Auto Source Switch+</p> <p>By activating, a new connected source is displayed automatically. <small>— This function may not be supported depending on the model or geographical area.</small></p> <p>USB-C Switch</p> <p>When there is no signal, the display automatically switches to the new device connected to the USB-C port. <small>— S27H80*UA / S32H80*UA / S40H85*T / S27H80*EF models only.</small></p>

2nd	Description
Key Repeat Time	Control the response rate of a button when the button is pressed. Acceleration, 1 sec or 2 sec can be selected. If No Repeat is selected, a command responds only once when a button is pressed.
Power LED On	Configure the settings to enable or disable the power LED located at the lower part of the product. <ul style="list-style-type: none"> Working: The power LED is on when the product is turned on. Stand-by: The power LED is on when the product is turned off.
Accessibility	Configures the accessibility options. <ul style="list-style-type: none"> SeeColors Mode: Allows users with color blindness to experience rich colors. Enable this feature to customize colors to suit your viewing conditions, to experience richer colors on the screen. <ul style="list-style-type: none"> Some menus are not available when SeeColors Mode is in use. This function may not be supported depending on the model. High Contrast: Increase the contrast between the text and background for the Settings menu. <ul style="list-style-type: none"> S27H70* / S32H70* / S27H80*EA / S32H80*EA / S27H80*UA / S32H80*UA / S27H80*EF models only. Grayscale: Change the color sense of the screen to black-and white tone. <ul style="list-style-type: none"> S27H70* / S32H70* / S27H80*EA / S32H80*EA / S27H80*UA / S32H80*UA / S27H80*EF models only. Color Inversion: Invert the colors of the Settings menu. White becomes black, black becomes white, and other colors are inverted according to RGB color values. <ul style="list-style-type: none"> S27H70* / S32H70* / S27H80*EA / S32H80*EA / S27H80*UA / S32H80*UA / S27H80*EF models only.

2nd	Description
USB-C Preference	Choose between high resolution and data transfer speed. If you change the settings during data transfer, the transfer may be canceled or data corruption may occur. <ul style="list-style-type: none"> High Resolution: If High Resolution is selected, 3840 x 2160 @ 60 Hz (S27H80*UA / S32H80*UA) / 5120 x 2880 @ 60 Hz (S27H80*EF) is available for input of USB-C. The performance for LAN and SS ports may be limited. The SS port operates as USB 2.0. High-Speed Data: If High-Speed Data is selected, 3840 x 2160 @ 60 Hz (S27H80*UA / S32H80*UA) / 5120 x 2880 @ 60 Hz (S27H80*EF) is not available for input of USB-C. The SS port operates as USB 3.0.
Setup Custom Key	Set the custom key so that your chosen function can be set up directly.
Best Brightness	Optimizes brightness in real time, based on your lighting environment. <ul style="list-style-type: none"> S40H85*T models only. This menu is not available when Adaptive Picture is enabled.

2nd	Description
Minimum Brightness	Set the minimum brightness for the monitor screen. This function only works if its value is lower than the value set in the Picture menu's Backlight setting. <small>— S40H85*T models only.</small>
VRR Control	By optimizing the video signal processing, this additional function mitigates screen flicker. While playing any game or content that causes screen flicker, use the VRR Control function with setting it to On . <small>— S40H85*T models only.</small>
Max. Power Saving	Set to on, Ethernet is turned off to save power. Set to off, the USB-C connected PC or laptop can be woken by LAN. <small>— S27H80*UA / S32H80*UA / S40H85*T / S27H80*EF models only.</small>

Support

2nd	Description
Self Diagnosis	Perform this test when you experience a problem with your monitor's picture. <small>— Never turn off the power nor change the input source during self diagnosis. If possible, try not to interrupt testing.</small>
Software Update	Update software using an update file on a USB device. <small>— S27H80*EA / S32H80*EA / S27H80*UA / S32H80*UA / S40H85*T / S27H80*EF models only.</small> <ol style="list-style-type: none"> 1 Save the update file (in .bin or .img format) that you downloaded from the Samsung website (http://www.samsung.com) to a USB storage device. 2 Connect the USB device to the SS ← (SERVICE) port on the monitor. Select □□□ → Support → Software Update. 3 Follow the instructions on the screen to proceed with update. 4 Your product will turn itself off and on again automatically after completing update, and then turn off your product. 5 Remove the power cord from the power outlet and then reconnect the cord after turning off. <small>— To perform software update by using a USB device, first format the USB device to FAT32. — When updating by a USB device, be sure to use the device whose version of USB 3.0 or lower. — When performing update, make sure that only one BIN or IMG file (.bin or .img) is saved in the root directory.</small>

2nd	Description
Software Update	<ul style="list-style-type: none"> — Upon updates, save only either the .bin or .image file, downloaded from the Samsung website, to the root directory. — If the No USB devices detected. Please check and try again. message is displayed, this is probably due to the following reasons. <ul style="list-style-type: none"> — A USB device is not connected to the SS ← (SERVICE) port. — The files in the connected USB device are not compatible formats. — There are no valid update files found in the connected USB device. (There are no update files saved in the memory or the file names are incorrect.) — The update will not start if the downloaded software does not match the software installed on the monitor. To check the software for consistency, select III → Support → Information. — Do not turn off the product until the update is complete. And prevent the updating from any interruption as far as possible. In general, the product returns to the previous version if an update is interrupted. — It may change the screen color or blink during USB update, but it is not a monitor problem. Since S/W update is performed normally, please wait until the update is finished.
Register Product	<p>Discover how to register your product.</p> <ul style="list-style-type: none"> — This function may not be supported depending on the model.
Information	View the current software information. Refer to the actual monitor screen.
Reset All	Return all the settings for the product to the default factory settings.

Troubleshooting

Requirements Before Contacting Samsung Customer Service Center

— Before calling Samsung Customer Service Center, test your product as follows. If the problem persists, contact Samsung Customer Service Center.

Product diagnosis (Screen issue)

If a problem occurs with the monitor screen, run [Self Diagnosis](#) to check that the monitor is working properly.

Checking the Resolution and Frequency

If a resolution that is not supported (see the [Standard Signal Mode Table](#)) is selected, the **Not Optimum Mode** message may appear for a short time or the screen may not be displayed properly.

— The displayed resolution may vary, depending on the PC system settings and cables.

Check the following.

Installation issue (PC mode)

Blank spaces are found on all four sides of the screen when an HDMI cable is connected to the product and PC.

The blank spaces found on the screen have nothing to do with the product.

Blank spaces on the screen are caused by the PC or graphics card. To resolve the problem, adjust the screen size in the HDMI settings for the graphics card.

If the graphics card settings menu does not have an option to adjust the screen size, update the graphics card driver to the latest version.

(Please contact the graphics card or PC manufacturer for further details about how to adjust the screen settings.)

Screen issue

The power LED is off. The screen will not turn on.

Check that the power cord is connected properly.

If a problem occurs with the monitor screen, run [Self Diagnosis](#) to check that the monitor is working properly.

The message **Check the cable connection and the settings of the source device.** appears.

Check that the cable is properly connected to the product.

Check that the device connected to the product is powered on.

Check the **PC/AV Mode** status. (□□□ → **System** → **PC/AV Mode** → **DisplayPort, HDMI, USB Type-C, Thunderbolt5/USB-C** → **PC** or **AV**.)

Set the connected **HDMI** or **DisplayPort** version.

- **HDMI** (□□□ → **System** → **Input Port Ver.**)
 - **1.4** or **2.0** (S27H70* / S32H70* / S27H80*EA / S32H80*EA / S27H80*UA / S32H80*UA)
 - **1.4** or **2.0** or **2.0**↑ (S40H85*T / S27H80*EF)
- **DisplayPort** (□□□ → **System** → **DisplayPort Ver.**)
 - **1.1** or **1.2**↑ (S27H70* / S32H70* / S27H80*EA / S32H80*EA / S27H80*UA / S32H80*UA)
 - **1.1** or **1.4** (S40H85*T / S27H80*EF)

Not Optimum Mode is displayed.

This message appears when the signal from the graphics card exceeds the maximum resolution or frequency for the product.

Change the maximum resolution and frequency to suit the product performance, referring to [Standard Signal Mode Table](#).

The images on the screen look distorted.

Check the cable connection to the product.

The screen is not clear. The screen is blurry.

Remove any accessories (video extension cable, etc.) and try again.

Set the resolution and frequency to the recommended level.

The screen appears unstable and shaky. There are shadows or ghost images left on the screen.

Check that the resolution and frequency for the PC are within the range of resolution and frequency compatible with the product. Next, if required, change the settings, referring to [Standard Signal Mode Table](#) in this manual and the **Information** menu on the product.

— Available functions may differ depending on the model.

The screen is too bright. The screen is too dark.

Adjust **Brightness** and **Contrast**.

Screen color is inconsistent.

Change the **Color** settings.

The colors on the screen have a shadow and are distorted.

Change the **Color** settings.

White does not really look white.

Change the **Color** settings.

There is no image on the screen and the power LED blinks every 0.5 to 1 second.

Check the cable connection between the product and PC, and ensure the connectors are locked.

Press any key on the keyboard or move the mouse to return to normal operating mode.

The product is operating in power-saving mode.

Text is blurry.

If using a Windows OS (e.g. Windows 7, Windows 8, Windows 8.1 or Windows 10): Go to **Control Panel** → **Fonts** → **Adjust ClearType text** and change **Turn on ClearType**.

Video playback is choppy.

Playback of high-definition large video files can be choppy. This may be because the video player is not optimized for the PC resource.

Try playing the file on another video player.

Sound issue

There is no sound.

Re-check the condition of the connected headphone or earphone or adjust the volume.

Check the volume.

Check whether the volume of the product or the source device is set to mute.

The volume is too low.

Adjust the volume.

If the volume is still low after turning it up to the maximum level, adjust the volume on your PC sound card or software.

Video is available but there is no sound.

Sound cannot be heard if an HDMI-DVI cable is used to connect the input device.

Connect the device using an HDMI cable or a DP cable.

Source device issue

A beeping sound is heard when my PC is booting.

If a beeping sound is heard when your PC is booting, have your PC serviced.

Other issue

When the product makes popping (cracking) sound.

The sound may be caused by contraction or expansion from temperature change of external components or internal circuit of the product.

This is NOT a product failure and does not affect the life of the product.

The product is getting hot.

It is normal for the product to generate some heat when used. The product has been tested and proven to be safe. You can use it with confidence. The heat generated by the product when used does not affect its performance or lifespan.

Specifications

General

Model Name	S27H70*	S32H70*
Size	27 Class (26.9 Inches / 68.4 cm)	32 Class (31.5 Inches / 80.0 cm)
Display area	596.7 mm (H) x 335.7 mm (V)	697.3 mm (H) x 392.2 mm (V)
Pixel Pitch	0.1554 mm (H) x 0.1554 mm (V)	0.18159 mm (H) x 0.18159 mm (V)
Maximum Pixel Clock	597.08 MHz	597.08 MHz

Model Name	S27H80*EA	S32H80*EA
Size	27 Class (26.9 Inches / 68.4 cm)	32 Class (31.5 Inches / 80.0 cm)
Display area	596.7 mm (H) x 335.7 mm (V)	697.3 mm (H) x 392.2 mm (V)
Pixel Pitch	0.1554 mm (H) x 0.1554 mm (V)	0.18159 mm (H) x 0.18159 mm (V)
Maximum Pixel Clock	597.08 MHz	597.08 MHz

Model Name	S27H80*UA	S32H80*UA
Size	27 Class (26.9 Inches / 68.4 cm)	32 Class (31.5 Inches / 80.0 cm)
Display area	596.7 mm (H) x 335.7 mm (V)	697.3 mm (H) x 392.2 mm (V)
Pixel Pitch	0.1554 mm (H) x 0.1554 mm (V)	0.18159 mm (H) x 0.18159 mm (V)
Maximum Pixel Clock	597.08 MHz	597.08 MHz

Model Name	S40H85*T	S27H80*EF
Size	40 Class (39.6 Inches / 100.6 cm)	27 Class (26.9 Inches / 68.4 cm)
Display area	926.8 mm (H) x 391.0 mm (V)	596.7 mm (H) x 335.7 mm (V)
Pixel Pitch	0.18102 mm (H) x 0.18102 mm (V)	0.1164 mm (H) x 0.1164 mm (V)
Maximum Pixel Clock	3196 MHz	940 MHz

Power Supply AC100-240V~ 50/60Hz
 Based on the AC voltage of the adapter. For the DC voltage of the product, refer to the product label.(S27H70* / S32H70*)
 Refer to the label at the back of the product as the standard voltage can vary in different countries.(S27H80*EA / S32H80*EA / S27H80*UA / S32H80*UA / S40H85*T / S27H80*EF)

Signal connectors S27H70* / S32H70* / S27H80*EA / S32H80*EA: HDMI, DisplayPort
 S27H80*UA / S32H80*UA / S27H80*EF: HDMI, DisplayPort, USB Type-C
 S40H85*T: HDMI, DisplayPort, Thunderbolt5/USB Type-C

Environmental conditions

Operating
 Temperature: 50 °F to 104 °F (10 °C to 40 °C)
 Humidity: 10 % to 80 %, non-condensing

Storage
 S27H70* / S32H70* / S27H80*EA / S32H80*EA / S27H80*UA / S32H80*UA / S40H85*T:
 Temperature: -4 °F to 113 °F (-20 °C to 45 °C)
 Humidity: 5 % to 95 %, non-condensing
 S27H80*EF:
 Temperature: -13 °F to 113 °F (-25 °C to 45 °C)
 Humidity: 5 % to 95 %, non-condensing

- **Plug-and-Play**
 This product can be installed and used with any Plug-and-Play compatible systems. Two-way data exchange between the product and PC system optimizes the product settings. Product installation takes place automatically. However, you can customize the installation settings if desired.
- **Panel Dots (Pixels)**
 Due to the nature of the manufacturing of this product, approximately 1 pixel per million (1ppm) may be brighter or darker on the LCD panel. This does not affect product performance.
- **Audio** is played with the same sound settings as the connected device. Audio sound settings (e.g. the bit and sample rates) can be changed from the connected device.
- The above specifications are subject to change without notice to improve quality.
- For detailed device specifications, visit the Samsung website.

(USA only)

Dispose unwanted electronics through an approved recycler. To find the nearest recycling location, go to our website: www.samsung.com/recycling or call, 1-800-Samsung

For battery recycling go to batterynetwork.org or call 1-800-822-8837



List of graphic cards supporting HDR10

HDR10 is accessible only on Windows 10 systems equipped with graphic cards that support Play Ready 3.0 Digital Rights Management (for protected HDR content). Use graphic cards listed below for HDR10.

- NVIDIA GeForce 1000 series or higher
- AMD Radeon™ RX 400 series or higher
- Intel UHD Graphics 600 series or higher

— Graphic cards that support hardware-accelerated 10-bit video decoding for HDR video codecs are recommended.

Licenses & Other Information



The terms HDMI, HDMI High-Definition Multimedia Interface, HDMI trade dress and the HDMI Logos are trademarks or registered trademarks of HDMI Licensing Administrator, Inc.



— This license may not be supported depending on the model or geographical area. Please refer to the samsung.com website for detailed information regarding FreeSync.

- Open Source License Notice
Open Source used in this product can be found on the following webpage (<https://opensource.samsung.com>).

Standard Signal Mode Table

Model Name			S27H70* / S32H70*
Synchronisation (PANEL Spec)	Vertical Frequency	60 Hz	
Resolution	Optimum resolution	3840 x 2160 @ 30 Hz (HDMI 1.4) 3840 x 2160 @ 60 Hz (HDMI 2.0, DP1.2)	
	Maximum resolution	3840 x 2160 @ 30 Hz (HDMI 1.4) 3840 x 2160 @ 60 Hz (HDMI 2.0, DP1.2)	

Model Name			S27H80*EA / S32H80*EA
Synchronisation (PANEL Spec)	Vertical Frequency	60 Hz	
Resolution	Optimum resolution	3840 x 2160 @ 30 Hz (HDMI 1.4) 3840 x 2160 @ 60 Hz (HDMI 2.0, DP1.2)	
	Maximum resolution	3840 x 2160 @ 30 Hz (HDMI 1.4) 3840 x 2160 @ 60 Hz (HDMI 2.0, DP1.2)	

Model Name			S27H80*UA / S32H80*UA
Synchronisation (PANEL Spec)	Vertical Frequency	60 Hz	
Resolution	Optimum resolution	3840 x 2160 @ 30 Hz (HDMI 1.4) 3840 x 2160 @ 60 Hz (HDMI 2.0, DP1.2, USB Type-C)	
	Maximum resolution	3840 x 2160 @ 30 Hz (HDMI 1.4) 3840 x 2160 @ 60 Hz (HDMI 2.0, DP1.2, USB Type-C)	

Model Name			S40H85*T
Synchronisation (PANEL Spec)	Vertical Frequency	48~144 Hz	
Resolution	Optimum resolution	5120 x 2160 @ 144 Hz	
	Maximum resolution	5120 x 2160 @ 144 Hz	

Model Name			S27H80*EF
Synchronisation (PANEL Spec)	Vertical Frequency	24~60 Hz	
Resolution	Optimum resolution	5120 x 2880 @ 60 Hz	
	Maximum resolution	5120 x 2880 @ 60 Hz	

If a signal that belongs to the following standard signal modes is transmitted from your PC, the screen will automatically be adjusted. If the signal transmitted from the PC does not belong to the standard signal modes, the screen may be blank even though the power LED turns on. In such a case, change the settings according to the following table by referring to the graphics card user manual.

S27H70* / S32H70* / S27H80*EA / S32H80*EA / S27H80*UA / S32H80*UA / S27H80*EF

Resolution	Horizontal Frequency (kHz)	Vertical Frequency (Hz)	Pixel Clock (MHz)	Sync Polarity (H/V)	Port	
					HDMI IN	DP IN / USB Type-C IN
VESA, 640 x 480	31.469	59.940	25.175	-/-	0	0
VESA, 800 x 600	37.879	60.317	40.000	+/+	0	0
VESA, 1024 x 768	48.363	60.004	65.000	-/-	0	0
VESA, 1280 x 720	45.000	60.000	74.250	+/+	0	0
VESA, 1280 x 800	49.702	59.810	83.500	-/+	0	0
VESA, 1280 x 1024	63.981	60.020	108.000	+/+	0	0
VESA, 1440 x 900	55.935	59.887	106.500	-/+	0	0
VESA, 1600 x 900	60.000	60.000	108.000	+/+	0	0
VESA, 1680 x 1050	65.290	59.954	146.250	-/+	0	0
VESA, 1920 x 1080	56.250	50.000	148.500	+/+	0	-
VESA, 1920 x 1080	67.500	60.000	148.500	+/+	0	0
VESA, 2560 x 1440	88.787	59.951	241.500	+/-	0	0
VESA, 3840 x 2160	67.500	30.000	297.000	+/+	0	0
VESA, 3840 x 2160	133.313	59.997	533.250	+/-	0	0
¹⁾ VESA, 5120 x 2880	177.699	60.000	938.25	+/-	0	0

S40H85*T

Resolution	Horizontal Frequency (kHz)	Vertical Frequency (Hz)	Pixel Clock (MHz)	Sync Polarity (H/V)	Port	
					HDMI IN	DP IN / USB Type-C IN
VESA, 640 x 480	31.469	59.940	25.175	-/-	0	0
VESA, 640 x 480	37.500	75.000	31.500	-/-	0	0
VESA, 800 x 600	37.879	60.317	40.000	+/+	0	0
VESA, 800 x 600	48.077	72.188	50.000	+/+	0	0
VESA, 800 x 600	46.875	75.000	49.500	+/+	0	0
VESA, 1024 x 768	48.363	60.004	65.000	-/-	0	0
VESA, 1024 x 768	56.476	70.069	75.000	-/-	0	0
VESA, 1024 x 768	60.023	75.029	78.750	+/+	0	0
VESA, 1152 x 864	67.500	75.000	108.000	+/+	0	0
VESA, 1280 x 720	45.000	60.000	74.250	+/+	0	0
VESA, 1280 x 800	49.702	59.810	83.500	-/+	0	0
VESA, 1280 x 1024	63.981	60.020	108.000	+/+	0	0
VESA, 1280 x 1024	79.976	75.025	135.000	+/+	0	0
VESA, 1440 x 900	55.935	59.887	106.500	-/+	0	0
VESA, 1600 x 900	60.000	60.000	108.000	+/+	0	0
VESA, 1680 x 1050	65.290	59.954	146.250	-/+	0	0
VESA, 1920 x 1080	67.500	60.000	148.500	+/+	0	0
VESA, 3440 x 1440	88.819	59.973	319.750	+/-	0	0
VESA, 3440 x 1440	183.000	120.000	644.160	+/-	0	0
VESA, 5120 x 2160	133.320	60.000	693.264	+/-	-	0
VESA, 5120 x 2160	333.216	144.000	1732.723	+/-	0	-



Resolution	Horizontal Frequency (kHz)	Vertical Frequency (Hz)	Pixel Clock (MHz)	Sync Polarity (H/V)	Port	
					HDMI IN	DP IN / USB Type-C IN
VESA, 2560 x 1440RB	88.787	59.951	241.500	+/-	0	0
VESA, 2560 x 1440RB	182.996	119.998	497.750	-/+	0	0
CEA, 720 x 480	31.469	59.940	27.000	-/-	0	0
CEA, 1280 x 720	45.000	60.000	74.250	+/+	0	0
CEA, 1920 x 1080	67.500	60.000	148.500	+/+	0	0
CEA, 1920 x 1080	135.000	120.000	297.000	+/+	0	0
CEA, 3840 x 2160	67.500	30.000	297.000	+/+	0	-
CEA, 3840 x 2160	135.000	60.000	594.000	+/+	0	-
Custom Timing, 1920 x 1080	166.587	144.000	346.500	+/-	0	0
Custom Timing, 1920 x 1080	266.346	239.951	554.000	+/-	0	0
Custom Timing, 1920 x 1080	334.495	299.996	695.750	+/-	-	0
Custom Timing, 1920 x 1080	289.352	239.927	625.000	+/-	0	0
Custom Timing, 2560 x 1080	166.544	144.000	453.000	+/-	0	0
Custom Timing, 2560 x 1440	222.151	144.000	604.250	+/-	0	0
Custom Timing, 2560 x 1440	385.542	239.765	1116.530	+/-	0	0
Custom Timing, 3440 x 1440	222.153	144.000	799.750	+/-	0	0
Custom Timing, 3840 x 2160	333.216	144.000	1332.750	+/-	0	0
Custom Timing, 5120 x 2160	277.440	120.000	1510.500	+/-	-	0
Custom Timing, 5120 x 2160	333.216	144.000	1789.000	+/-	-	0
Custom Timing, 5120 x 2160	333.769	144.000	1789.000	+/-	0	-

— ¹⁾ This input signal is supported on S27H80*EF.

— USB Type-C is supported on the S27H80*UA / S32H80*UA / S40H85*T / S27H80*EF models only.

— Horizontal Frequency

The time required to scan a single line from the left to the right side of the screen is called a horizontal cycle. The reciprocal number of a horizontal cycle is called horizontal frequency. Horizontal frequency is measured in kHz.

— Vertical Frequency

Repeating the same picture dozens of times per second allows you to view natural pictures. The repeat frequency is called "vertical frequency" or "refresh rate" and is indicated in Hz.

— This product can be set to only one resolution for each screen size to obtain the optimum picture quality due to the nature of the panel. Using a resolution other than the specified resolution may degrade the picture quality. To avoid this, it is recommended that you select the optimum resolution specified for your product.

— Some resolutions listed in the table above may not be available depending on graphics card specifications.

Appendix

Responsibility for the Pay Service (Cost to Customers)

— When the service is requested, in spite of in warranty, we may charge you for a visit from a service technician in the following cases.

Not a product defect

Cleaning of the product, Adjustment, Explanation, Re-installation and etc.

- If a service technician is requested to give instructions on how to use product or simply adjusts options without disassembling product.
- If a defect is caused by external environmental factors (Internet, Antenna, Wired Signal, etc.)
- If a product is reinstalled or devices are connected additionally after installing the purchased product for the first time.
- If a product is reinstalled to move to a different spot or to move to a different house.
- If the customer requests instructions on how to use another company's product.
- If customer requests instructions on how to use the network or another company's program.
- If customer requests software installation and setup for the product.
- If a service technician removes/cleans dusts or foreign materials inside of the product.
- If customer requests an installation additionally after purchasing a product through home-shopping or online.

A Product damage caused by customer's fault

Product damage caused by customer's mishandling or wrong repair

If a product damage is caused by;

- External impact or drop.
- Use of supplies or separately sold product unspecified by Samsung.
- Repair from a person besides an engineer of outsourcing service company or partner of Samsung Electronics Co., Ltd.
- Remodeling or repairing the product by customer.
- Using it with incorrect voltage or non-authorized electrical connections.
- Not following the "cautions" in User guide.

Others

- If product fails by natural disaster. (lightning, fire, earthquake, flood damage, etc)
- If consumable components are all used up. (Battery, Toner, Fluorescent lights, Head, Vibrator, Lamp, Filter, Ribbon, etc.)

— If customer requests a service in case the product has no defect, service fee may be charged. So please read User guide first.

FreeSync (for AMD graphics card)

— This function may not be supported depending on the model.

FreeSync technology is solution that eliminates screen tearing without all the usual lag and latency.

This feature will eliminate screen tearing and lag during game play. Improve your gaming experience.

The displayed FreeSync menu items on the monitor may vary, depending on the monitor model and compatibility with the AMD graphics card.

- **Off:** Disable FreeSync.
- **On:** Turn on the AMD graphics cards' FreeSync function. You may experience intermittent flickers when playing some games.

Apply the optimum resolution when using FreeSync.

The refresh rate setting method please refer to Q & A → How can I change the frequency?

— This menu is not available when **PC/AV Mode** is set to **AV**.

— This menu is not available when **PIP Mode** (or **PIP/PBP Mode**) is enabled.

— The FreeSync function is only enabled in **HDMI** or **DisplayPort** mode.
Use the HDMI/DP cable provided by the manufacturer when using FreeSync.

— If the FreeSync function is in use and the text displayed on the PC screen looks blurry or corrupted, resolve the issue by changing the resolution of the PC screen to the recommended resolution.

— If the **DisplayPort Ver.** is set to **1.1**, the **FreeSync / FreeSync Premium / FreeSync Premium Pro** mode is disabled.

— If the **DisplayPort Ver.** is set to **1.2**, the **FreeSync / FreeSync Premium / FreeSync Premium Pro** mode is disabled.

If you use the FreeSync function while playing a game, the following symptoms may occur:

- The screen may flicker depending on the type of graphics card, the game option settings, or the video being played. Try the following actions: decrease the game setting values, change the current **FreeSync / FreeSync Premium / FreeSync Premium Pro** mode to **Off**, or visit the AMD website to check your graphics driver's version and update it with the latest one.

- While you are using the FreeSync function, the screen may flicker due to variation of the output frequency from the graphics card.
- The response rate during the game may fluctuate depending on the resolution. A higher resolution generally decreases the response rate.
- The sound quality of the monitor may be degraded.

— If you encounter any issues when using the function, contact the Samsung Service Center.

— If you change the screen resolution while the function is **On**, the screen may intermittently blank out due to the graphic card. Set **FreeSync / FreeSync Premium / FreeSync Premium Pro** to **Off** and change the resolution.

— The function is unavailable in the devices (e.g. AV devices) that have no AMD graphic card. If the function is applied, the screen may have malfunction.

The models in the Graphics Cards list supports FreeSync

FreeSync can only be used with specific AMD graphics card models. Refer to the following list for supported graphics cards:

Make sure to install the latest official graphics drivers from AMD that support FreeSync.

— For additional AMD graphics card models that support the FreeSync feature, visit the official AMD website.

— Select **FreeSync / FreeSync Premium / FreeSync Premium Pro Off** if you are using a graphics card from a different manufacturer.

— When applying the FreeSync function through the HDMI cable, it may fail to work due to the bandwidth limitation of certain AMD graphics card.

- | | |
|---|---|
| • Radeon™ RX Vega series | • Radeon™ Pro Duo (2016 edition) |
| • Radeon™ RX 500 series | • Radeon™ R9 Nano series |
| • Radeon™ RX 400 series | • Radeon™ R9 Fury series |
| • Radeon™ R9/R7 300 series (excluding R9 370/X, R7 370/X, R7 265) | • Radeon™ R9/R7 200 series (excluding R9 270/X, R9 280/X) |

Adaptive-Sync (for NVIDIA graphics card)

— This function may not be supported depending on the model.

Adaptive-Sync technology is a solution that eliminates screen tearing without all the usual lag and latency.

This feature will eliminate screen tearing and lag during game play. Improve your gaming experience.

The displayed **Adaptive-Sync** menu items on the product may vary, depending on the product model and compatibility with the NVIDIA graphics card.

- **Off:** Disable **Adaptive-Sync**.
- **On:** Enable the **Adaptive-Sync** feature with a higher screen frame rate. Screen tearing (abnormal sync between the screen and content) is reduced in this mode. Note, however, that intermittent screen flickering may occur during gameplay.

If you use the **Adaptive-Sync** function while playing a game, the following symptoms may occur:

- The screen may flicker depending on the type of graphics card, the game option settings, or the video being played. Try the following actions: decrease the game setting values, or visit the NVIDIA website to check your graphics driver's version and update it with the latest one.
- When using the **Adaptive-Sync** function, the screen may flicker due to the fluctuation of output frequency from the graphics card.
- The response rate during the game may fluctuate depending on the resolution. A higher resolution generally decreases the response rate.
- The sound quality of the product may be degraded.

— If you encounter any issues when using the function, contact the Samsung Service Center.

— When the resolution is changed while setting **Adaptive-Sync**, the screen tearing can happen intermittently. Set **Adaptive-Sync** to **Off** and change the resolution.

— The function is unavailable in the devices (e.g. AV devices) that have no NVIDIA graphics card. If the function is applied, the screen may malfunction.

— Depending on the source device, 4K output from an AV device is supported only when the **Adaptive-Sync** is **Off**.

— Use the DisplayPort cable provided by the manufacturer when using **Adaptive-Sync**.

— Install the latest NVIDIA graphics card driver to enable **Adaptive-Sync**.

— Use Windows 10 or higher to enable **Adaptive-Sync**.

— If the **Adaptive-Sync** function is in use and the text displayed on the PC screen looks blurry or corrupted, resolve the issue by changing the resolution of the PC screen to the recommended resolution.

— If the **DisplayPort Ver.** is set to **1.1**, the **Adaptive-Sync** mode is disabled.

— If you set the **HDMI Mode** to **1.4**, the **Adaptive-Sync** mode is disabled.

The models in the Graphics Cards list supports Adaptive-Sync

Adaptive-Sync can only be used with specific NVIDIA graphics card models. Refer to the following list for supported graphics cards:

Make sure to install the latest official graphics drivers from NVIDIA that support **Adaptive-Sync**.

— For additional NVIDIA graphics card models that support the **Adaptive-Sync** feature, visit the official NVIDIA website.

— Select **Adaptive-Sync Off** if you are using a graphics card from a different manufacturer.

— When applying the **Adaptive-Sync** function through the DisplayPort cable, it may fail to work due to the bandwidth limitation of certain NVIDIA graphics card.

- GeForce GTX 10 series
- GeForce RTX 20 series
- GeForce RTX 30 series
- GeForce RTX 40 series
- GeForce RTX 50 series

TCO CERTIFIED

- A third-party certification according to ISO 14024
- Applies to TCO-certified models only.



Toward sustainable IT products

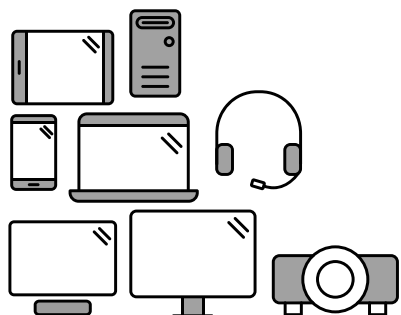

Say hello to a more sustainable product

IT products are associated with a wide range of sustainability risks throughout their life cycle. Human rights violations are common in the factories. Harmful substances are used both in products and their manufacture. Products can often have a short lifespan because of poor ergonomics, low quality and when they are not able to be repaired or upgraded.

This product is a better choice. It meets all the criteria in TCO Certified, the world's most comprehensive sustainability certification for IT products. Thank you for making a responsible product choice, that help drive progress towards a more sustainable future!

Criteria in TCO Certified have a life-cycle perspective and balance environmental and social responsibility. Conformity is verified by independent and approved verifiers that specialize in IT products, social responsibility or other sustainability issues. Verification is done both before and after the certificate is issued, covering the entire validity period. The process also includes ensuring that corrective actions are implemented in all cases of factory non-conformities. And last but not least, to make sure that the certification and independent verification is accurate, both TCO Certified and the verifiers are reviewed regularly.

Want to know more?

Read information about TCO Certified, full criteria documents, news and updates at tcocertified.com. On the website you'll also find our Product Finder, which presents a complete, searchable listing of certified products.

Product warranty information

- Minimum included product warranty : 1~3 years
- Minimum purchasable extended warranty : 2~4 years
- Total available warranty (free + extended) : 5 years
- The maximum cost per year for the extended warranty : under 15% of product cost

— The warranty period may vary by region and model.

Software updates

Samsung guarantees the availability of free-of-charge security updates, corrective updates and functionality updates to the operating system for at least 5 years after the end of placement on the market. You can download the latest version of software from the [Samsung.com](https://www.samsung.com/support) support page.