



KLIM BLAZE USER MANUAL

INDEX

INTRODUCTION	3
Features	3
PRODUCT DIAGRAM	3
INSTALLATION	4
Mouse installation	4
Driver Installation	4
USING THE DRIVER	4
Main Screen	4
Button Settings	5
Advanced Screen	5
Mouse Settings	6
Macros	6
Creating and editing a macro	7
Inserting an event	7
Delete/Modify an event	7
Using a macro	8
Lighting	8
OTHER OPTIONS	9
Exporting and importing profiles	9
Saving a profile	9
Loading a profile	9
TROUBLESHOOTING	10

INTRODUCTION

On behalf of the entire KLIM Team, thank you for purchasing our KLIM Blaze wireless gaming mouse. We hope it meets your expectations and that you enjoy using this device.

Features

- Rechargeable battery
- RGB rim
- Wired & Wireless mode
- Omron Gaming Switches
- Up to 6000 DPI
- Wireless range up to 10 meters

PRODUCT DIAGRAM

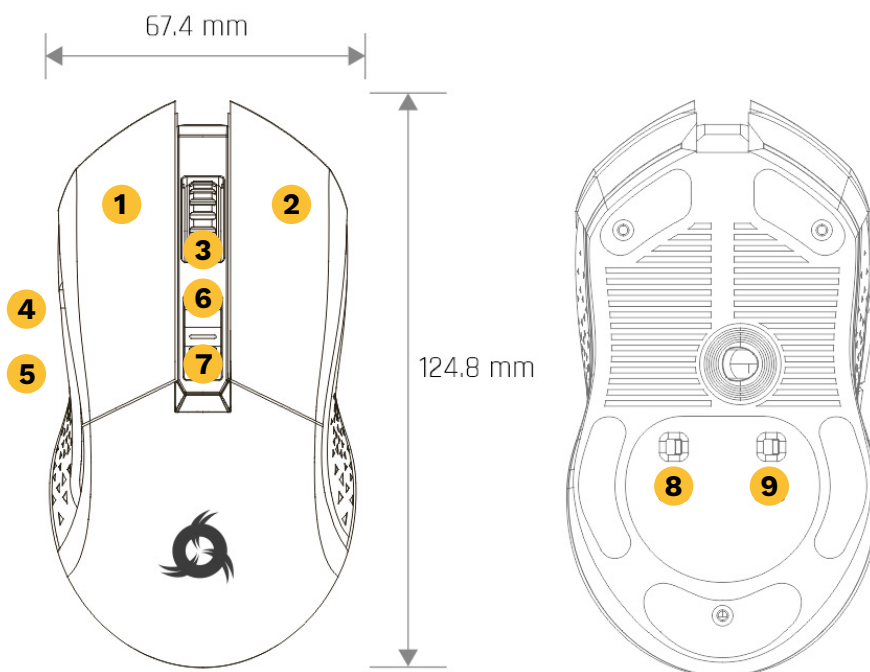

- 1 Left click
- 2 Right click
- 3 Mid click and scroll wheel
- 4 Forward
- 5 Backward
- 6 DPI +
- 7 DPI -
- 8 Lights switch
- 9 On/Off Switch

INSTALLATION

Mouse installation

Wireless mode: connect the USB receiver to your PC and move the switch located under the mouse to the ON position.

Wired mode: connect the mouse to your PC via the USB cable.

In the event it does not light up or is not recognized by the system, please refer to the Troubleshooting section at the end of this manual.

Driver Installation

Our dedicated software for Windows lets you customize several aspects such as lighting, button mapping, macros and more.

You can download it from our website: www.klimtechs.com/manual

NOTE: if you receive a warning indicating that the program is potentially harmful, this is due to Windows certifications. We are in the process of obtaining these certifications. However, the driver remains perfectly safe to use.

Once the driver has been downloaded you can use a decompressing tool such as WinRAR to extract the file. Once in your hard drive, double click on the KLIM_Blaze_Setup.exe to start the installation process

USING THE DRIVER

MAIN SCREEN

Once you open the driver, it will show its main screen, which allows you to adjust Report Rate, check the battery level, and change what each button does.

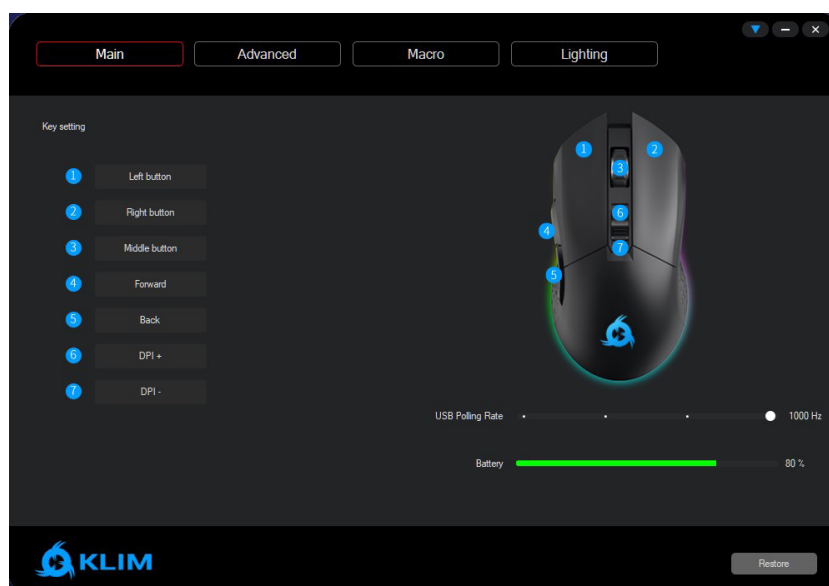

Button Settings

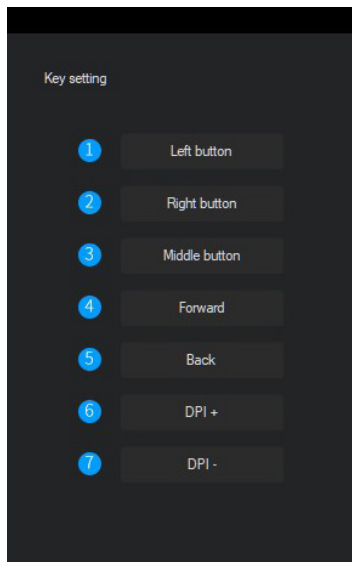

Click on the desired button to customize and select a new function for that button. You may also assign macros after they are created (refer to section Macros below).

To revert back to the original values, click Restore.

IMPORTANT: the Restore button resets ALL settings to their default values, including buttons, DPI and Lighting. Macros are still preserved but become unassigned from any buttons.

ADVANCED SCREEN

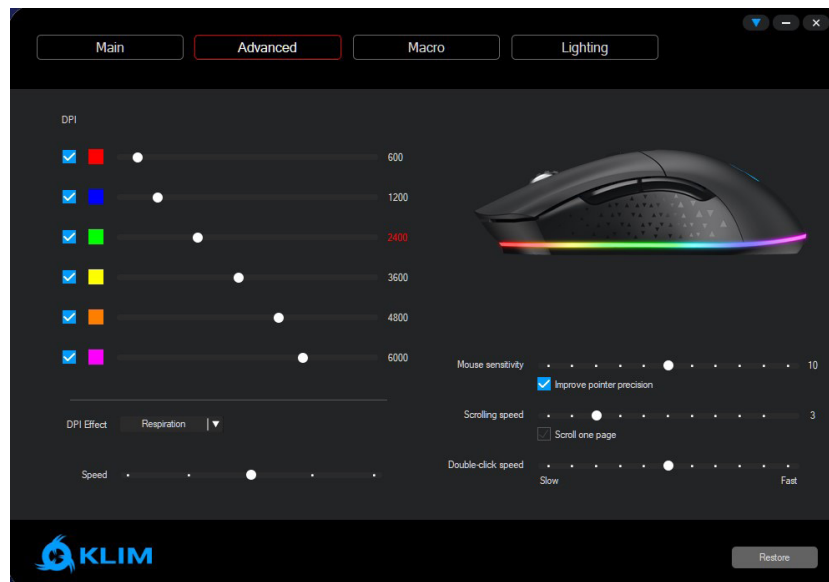

The KLIM Blaze has 6 different DPI levels, which you can change using the DPI + and DPI - buttons (6 & 7). Use this screen to specify the DPI for each one of the 6 levels. If you prefer to have less DPI levels, tick the checkbox on the left so that the mouse loops only between the selected levels.

Use the sliders to select what DPI to set for each level.

Logo color:

The logo on the mouse changes colors depending on the DPI levels. Use the DPI effect menu to change between Steady, Respiration or Off modes.

Steady mode: the logo is always lit. Use the Brightness slider to select the brightness level

Respiration: the logo turns on and off. Use the Speed slider to control the speed of the effect.

Click on the colored square to change the color that corresponds to each DPI level. If you prefer to always see the same color regardless of the current DPI, select the same color for all levels.

Note: battery charging status is also indicated by the logo light. This indication overrides any custom DPI lighting. Once the mouse is done charging, you can unplug it to display your selected colors.

Mouse Settings

On the bottom-right corner of the Advanced screen, you may adjust the Mouse sensitivity, Scrolling speed and Double click speed.

Note: you may also change these settings directly on Windows.

For maximum accuracy we suggest disabling Enhance Pointer Precision.

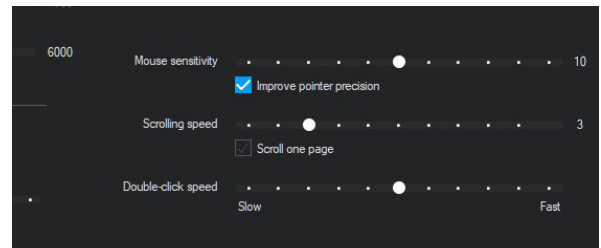

MACROS

Macros allow you to perform a number of predefined actions with a single mouse button press. The Macro window lets you create, save and edit macros.

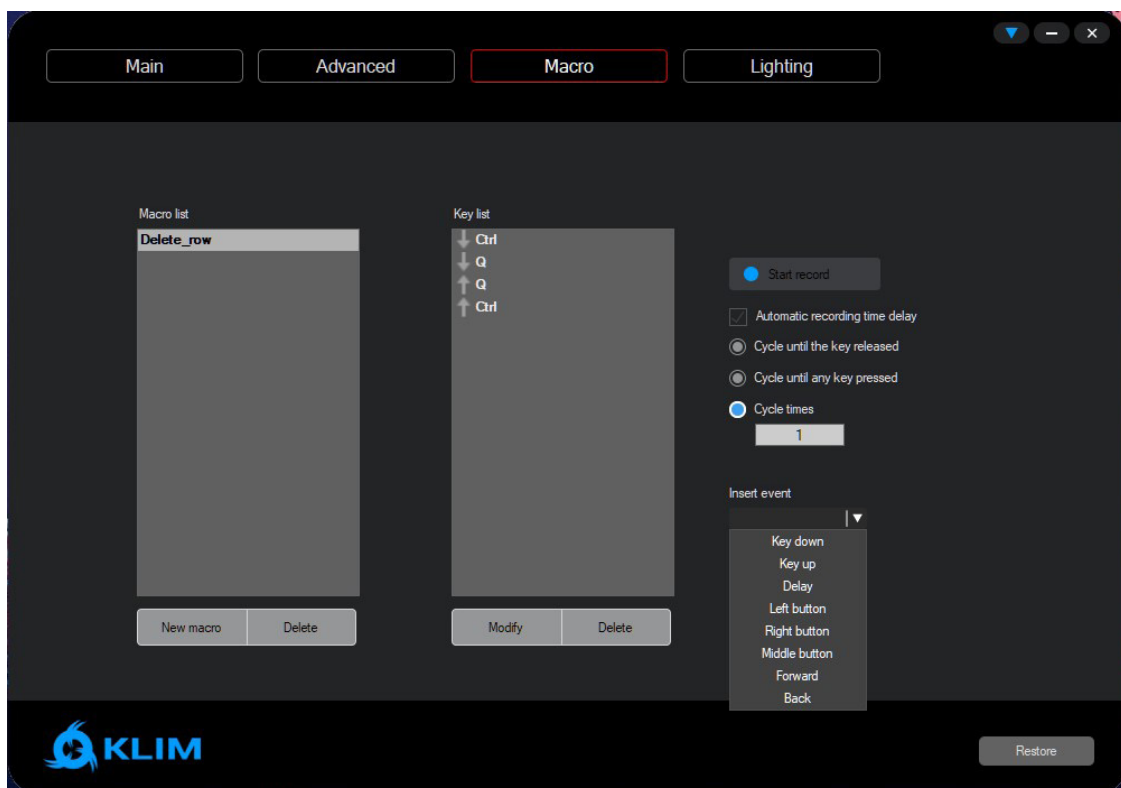

Creating and editing a macro

1. Click on New Macro and write a Macro Name.
2. Check or uncheck the “Automatic recording time delay” depending on your needs:
When checked, it will record the key presses in real time
When unchecked, it will only record the key presses one right after the other
3. Click Start Record and use the keyboard to record a sequence of key presses for this macro.
4. When done, click Stop Record.
5. Review your macro. If you need to add mouse clicks, or modify any events, refer to the next section: “Deleting/Modifying events” and “Inserting events”.
6. Select the cycle type based on your needs:
Cycle until the key released: the macro plays as long as you press down the mouse button.
Cycle until any key pressed: the macro plays infinitely until you press another mouse button.
Cycle times: the macro plays a fixed number of times with each press of the mouse button.
7. Click the **Save** button.

Inserting an event

Use the Insert Event dropdown to include mouse actions, keyboard actions, or add delay if needed. The event is added at the end of the sequence if no event is selected, or above the selected event.

You may delete key presses by right clicking on them, or adjust the delay between key presses by double clicking on the delay event. The default delay is 50 ms.

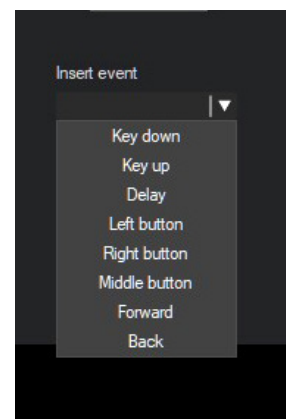

Delete/Modify an event

Right click on an event and select **Delete** or **Modify**.

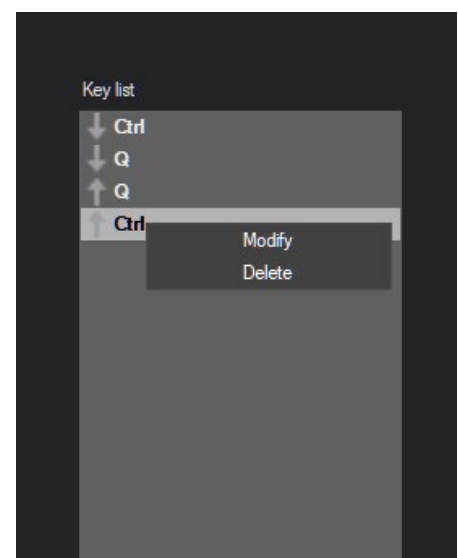

Using a macro

1. Access the Main menu on the top-left side of the screen.
2. Click on the button (1-7) you would like to assign the macro to, then select Macro and choose a macro you have previously created.

Note: if you can't find your macro listed in the dialog box, check that it was properly saved in the Macro menu.

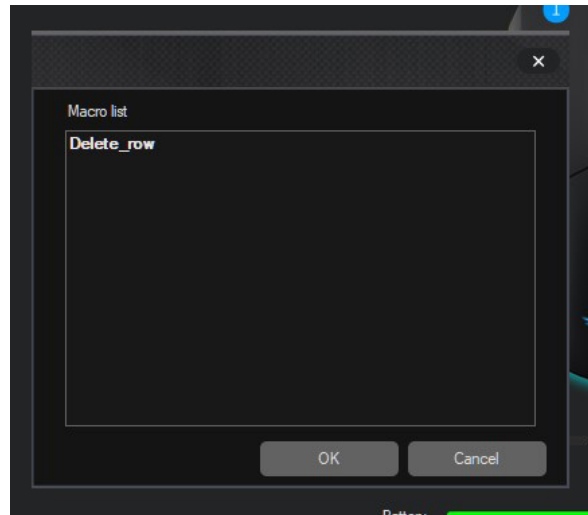
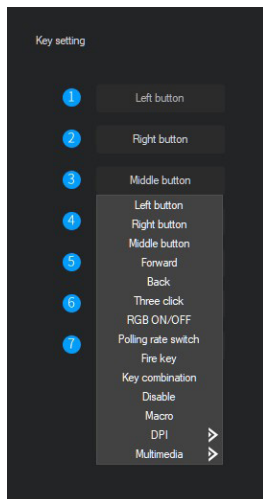

LIGHTING

Click on Lighting to access color and effect customization. You may select different modes and change their brightness, speed and/or color (for selected modes only).

Available effects:

- **Steady**
- **Respiration**
- **Streaming**
- **Off**

Select a predefined color or enter a custom RGB value to update the rim's lighting.

Note: selecting a lower brightness or disabling the RGB rim significantly increases battery duration.

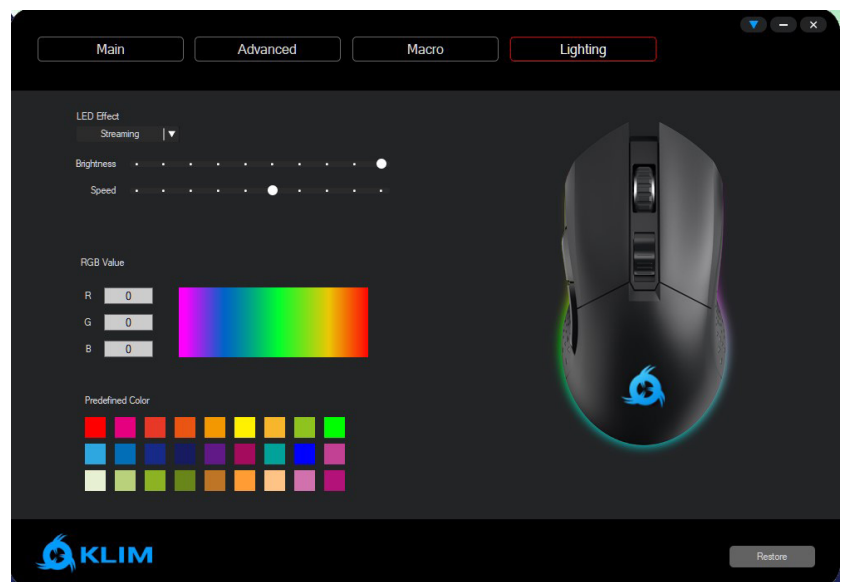

OTHER OPTIONS

Exporting and importing profiles

Click on the blue arrow on the top-right corner of any screen to export or import profiles.

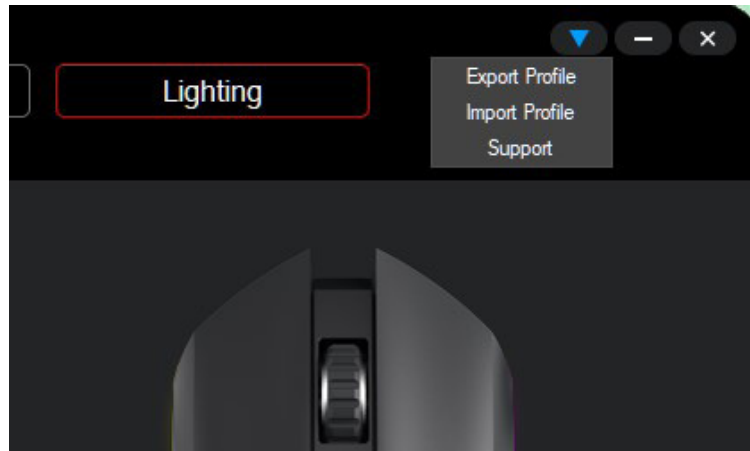

This can be useful to transfer settings to another computer, or to keep multiple macro, lighting or DPI profiles for easy switching.

For example, you could have an “office” profile with productivity macros & settings, a “gaming” profile with optimized DPI settings and macros for videogames, and an “energy-saving” mode with low brightness for increased battery duration.

Saving a profile

Select Export Profile. On the new dialog window, rename the file and save it.

Loading a profile

Select Import Profile. On the new dialog window, find the previously saved .jmk file and open it.

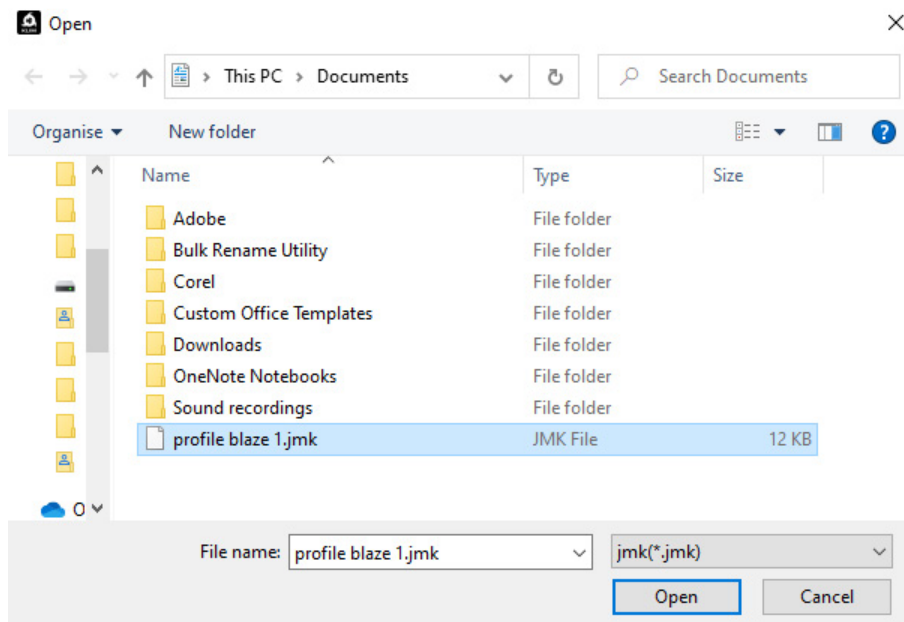

TROUBLESHOOTING

If you ever encounter any problems, remember that we remain at your disposal to help you with any issues. Do not hesitate to contact us at support@klimtechnologies.com for additional support.

I have installed the software but it does not open.

The software is executed automatically once installed. In order to display it, look for the KLIM Blaze icon on your Windows task tray and click on it.

The mouse only works when the cable is connected.

Verify that the ON/OFF switch under the mouse is in the ON position. Make sure that the wireless receiver is connected to your computer. Lastly, check the battery level to ensure it's not depleted.

The lights stay on even after I switch off my computer.

Some computers provide energy to the USB ports even if the computer is off. You can usually solve this by accessing your BIOS energy options and activating ErP. If you are not sure about this procedure, please contact us.

The mouse pointer behaves erratically while in wireless mode.

Check the battery levels and fully charge the mouse battery, then try again. Also, ensure you are within the maximum wireless range of 10 m/30 ft. Make sure there are no obstacles between the mouse and the USB receiver: if so, try plugging the receiver to a more exposed port (such as a frontal port on your computer). If the problem persists, please contact us directly.

We thank you again for your purchase and hope that you enjoy using our KLIM Blaze Wireless Gaming mouse.

The KLIM Team