



**BOSCH**



**Register** your  
new device on  
MyBosch now and  
get free benefits:  
**[bosch-home.com/  
welcome](https://bosch-home.com/welcome)**

# Built-in oven

**VBD578FS0**

**[en]** Instruction manual

Built-in oven



# Table of contents

 <b>Intended use</b> . . . . .	4	 <b>Cleaning</b> . . . . .	17
 <b>Important safety information</b> . . . . .	4	Suitable cleaning agents . . . . .	17
General information . . . . .	4	Keeping the appliance clean . . . . .	18
Cleaning function . . . . .	5	Cleaning the cooking compartment . . . . .	18
 <b>Causes of damage</b> . . . . .	6	 <b>Cleaning function</b> . . . . .	19
General information . . . . .	6	Pyrolytic self-cleaning . . . . .	19
 <b>Environmental protection</b> . . . . .	7	 <b>Rails</b> . . . . .	20
Saving energy . . . . .	7	Detaching the shelf supports . . . . .	20
Environmentally-friendly disposal . . . . .	7	Refitting the shelf supports . . . . .	20
 <b>Getting to know your appliance</b> . . . . .	8	 <b>Appliance door</b> . . . . .	20
Control panel . . . . .	8	Removing and installing the door panels . . . . .	20
Buttons . . . . .	8	Removing and fitting the appliance door . . . . .	21
Display . . . . .	8	 <b>Trouble shooting</b> . . . . .	22
Types of heating and functions . . . . .	9	Fault messages . . . . .	22
Temperature selector . . . . .	9	Replacing the oven light bulb . . . . .	23
Cooking compartment functions . . . . .	10	 <b>Customer service</b> . . . . .	23
 <b>Accessories</b> . . . . .	10	E number and FD number . . . . .	23
Shelf positions . . . . .	10	 <b>Tested for you in our cooking studio</b> . . . . .	24
Locking function . . . . .	11	Table of dishes . . . . .	24
Telescopic rail set . . . . .	11	Tips for using your appliance . . . . .	25
Special accessories . . . . .	11		
 <b>Before using for the first time</b> . . . . .	12		
Setting the time on the clock . . . . .	12		
Baking out the oven . . . . .	12		
Cleaning the accessories . . . . .	12		
Fitting the telescopic shelf set . . . . .	12		
 <b>Operating the appliance</b> . . . . .	13		
Switching the oven on and off . . . . .	13		
Rotary spit . . . . .	13		
Automatic safety switch-off function . . . . .	14		
 <b>Time-setting options</b> . . . . .	14		
Overview of the time-setting options . . . . .	14		
Operating the electronic clock . . . . .	14		
Setting the automatic timer . . . . .	15		
 <b>Childproof lock</b> . . . . .	16		
Activating the childproof lock . . . . .	16		
Deactivating the childproof lock . . . . .	16		
 <b>Basic settings</b> . . . . .	16		
List of basic settings . . . . .	16		
Changing the basic settings . . . . .	17		
Setting energy-saving mode . . . . .	17		

---

Additional information on products, accessories, replacement parts and services can be found at [www.bosch-home.com](http://www.bosch-home.com) and in the online shop [www.bosch-eshop.com](http://www.bosch-eshop.com)

## Intended use

Read these instructions carefully. Only then will you be able to operate your appliance safely and correctly. Retain the instruction manual and installation instructions for future use or for subsequent owners.

This appliance is only intended to be fully fitted in a kitchen. Observe the special installation instructions.

Check the appliance for damage after unpacking it. Do not connect the appliance if it has been damaged in transport.

Only a licensed professional may connect appliances without plugs. Damage caused by incorrect connection is not covered under warranty.

This appliance is intended for domestic use only. The appliance must only be used for the preparation of food and drink. The appliance must be supervised during operation. Only use this appliance indoors.

This appliance is intended for use up to a maximum height of 2000 metres above sea level.

This appliance is not intended for operation with an external clock timer or a remote control.

This appliance may be used by children over the age of 8 years old and by persons with reduced physical, sensory or mental capabilities or by persons with a lack of experience or knowledge if they are supervised or are instructed by a person responsible for their safety how to use the appliance safely and have understood the associated hazards.

Children must not play with, on, or around the appliance. Children must not clean the appliance or carry out general maintenance unless they are at least 15 years old and are being supervised.

Keep children below the age of 8 years old at a safe distance from the appliance and power cable.

Always slide accessories into the cooking compartment the right way round.

→ "Accessories" on page 10

## Important safety information

### General information

#### Warning – Risk of fire!

- Combustible items stored in the cooking compartment may catch fire. Never store combustible items in the cooking compartment. Never open the appliance door if there is smoke inside. Switch off the appliance and unplug it from the mains or switch off the circuit breaker in the fuse box.
- Loose food remnants, fat and meat juices may catch fire. Before using the appliance, remove the worst of the food remnants from the cooking compartment, heating elements and accessories.
- A draught is created when the appliance door is opened. Greaseproof paper may come into contact with the heating element and catch fire. Do not place greaseproof paper loosely over accessories during preheating. Always weight down the greaseproof paper with a dish or a baking tin. Only cover the surface required with greaseproof paper. Greaseproof paper must not protrude over the accessories.

#### Warning – Risk of burns!

- The appliance becomes very hot. Never touch the interior surfaces of the cooking compartment or the heating elements. Always allow the appliance to cool down. Keep children at a safe distance.
- Accessories and ovenware become very hot. Always use oven gloves to remove accessories or ovenware from the cooking compartment.
- Alcoholic vapours may catch fire in the hot cooking compartment. Never prepare food containing large quantities of drinks with a high alcohol content. Only use small quantities of drinks with a high alcohol content. Open the appliance door with care.
- The telescopic shelves become hot when the appliance is in use. Take special care not to get burnt when they are pulled out.

**⚠ Warning – Risk of scalding!**

- The accessible parts become hot during operation. Never touch the hot parts. Keep children at a safe distance.
- When you open the appliance door, hot steam can escape. Steam may not be visible, depending on its temperature. When opening, do not stand too close to the appliance. Open the appliance door carefully. Keep children away.
- Water in a hot cooking compartment may create hot steam. Never pour water into the cooking compartment when the cooking compartment is hot.

**⚠ Warning – Risk of injury!**

- Scratched glass in the appliance door may develop into a crack. Do not use a glass scraper, sharp or abrasive cleaning aids or detergents.
- The hinges on the appliance door move when opening and closing the door, and you may be trapped. Keep your hands away from the hinges.

**⚠ Warning – Risk of electric shock!**

- Incorrect repairs are dangerous. Repairs may only be carried out by one of our trained after-sales engineers. If the appliance is faulty, unplug the mains plug or switch off the fuse in the fuse box. Contact the after-sales service.
- The cable insulation on electrical appliances may melt when touching hot parts of the appliance. Never bring electrical appliance cables into contact with hot parts of the appliance.
- Do not use any high-pressure cleaners or steam cleaners, which can result in an electric shock.
- When replacing the cooking compartment bulb, the bulb socket contacts are live. Before replacing the bulb, unplug the appliance from the mains or switch off the circuit breaker in the fuse box.
- A defective appliance may cause electric shock. Never switch on a defective appliance. Unplug the appliance from the mains or switch off the circuit breaker in the fuse box. Contact the after-sales service.

**Cleaning function****⚠ Warning – Risk of fire!**

- Loose food residues, grease and meat juices may catch fire during the cleaning function. Before starting the cleaning function, remove coarse dirt from the cooking compartment and from the accessories.
- The appliance will become very hot on the outside during the cleaning function. Never hang combustible objects, e.g. tea towels, on the door handle. Do not place anything against the front of the appliance. Keep children away from the appliance.
- If the door seal is damaged, a large amount of heat will be generated around the door. Do not scrub or remove the seal. Never operate the appliance if the seal is damaged or missing.

**⚠ Warning – Risk of serious damage to health!**

The appliance will become very hot during the cleaning function. The non-stick coating on baking trays and tins is destroyed and noxious gases are released. Never clean non-stick baking trays and baking tins using the cleaning function. Only clean enamelled accessories using the cleaning function.

**⚠ Warning – Risk of harm to health!**

The cleaning function heats up the cooking compartment to a very high temperature so that food remnants left over from roasting, grilling and baking will burn off. This process releases vapours, which can irritate the mucous membranes. While the cleaning function is running, keep the kitchen well ventilated. Do not remain in the room for long periods. Keep children and pets away. Follow the instructions even when using the Delayed start function with a delayed end time.

**⚠ Warning – Risk of burns!**

- The cooking compartment becomes extremely hot during the cleaning function. Never open the appliance door. Allow the appliance to cool down. Keep children away from the appliance.
- ⚠ The appliance becomes very hot on the outside during the cleaning function. Never touch the appliance door. Allow the appliance to cool down. Keep children at a safe distance.

## Causes of damage

### General information

#### Caution!

- Accessories, foil, greaseproof paper or ovenware on the cooking compartment floor: do not place accessories on the cooking compartment floor. Do not cover the cooking compartment floor with any sort of foil or greaseproof paper. Do not place ovenware on the cooking compartment floor if a temperature of over 50 °C has been set. This will cause heat to accumulate. The baking and roasting times will no longer be correct and the enamel will be damaged.
- Aluminium foil: Aluminium foil in the cooking compartment must not come into contact with the door glass. This could cause permanent discolouration of the door glass.
- Water in a hot cooking compartment: do not pour water into the cooking compartment when it is hot. This will cause steam. The temperature change can cause damage to the enamel.
- Moisture in the cooking compartment: Over an extended period of time, moisture in the cooking compartment may lead to corrosion. Allow the cooking compartment to dry after use. Do not keep moist food in the closed cooking compartment for extended periods of time. Do not store food in the cooking compartment.
- Cooling with the appliance door open: Following operation at high temperatures, only allow the cooking compartment to cool down with the door closed. Do not trap anything in the appliance door. Even if the door is only left open a crack, the front of nearby furniture may become damaged over time. Only leave the cooking compartment to dry with the door open if a lot of moisture was produced whilst the oven was operating.
- Fruit juice: when baking particularly juicy fruit pies, do not pack the baking tray too generously. Fruit juice dripping from the baking tray leaves stains that cannot be removed. If possible, use the deeper universal pan.
- Extremely dirty seal: If the seal is very dirty, the appliance door will no longer close properly during operation. The fronts of adjacent units could be damaged. Always keep the seal clean. Never operate the appliance if the seal is damaged or missing. → *"Cleaning" on page 17*
- Appliance door as a seat, shelf or worktop: Do not sit on the appliance door, or place or hang anything on it. Do not place any cookware or accessories on the appliance door.
- Inserting accessories: depending on the appliance model, accessories can scratch the door panel when closing the appliance door. Always insert the accessories into the cooking compartment as far as they will go.
- Carrying the appliance: do not carry or hold the appliance by the door handle. The door handle cannot support the weight of the appliance and could break.

## Environmental protection

Your new appliance is particularly energy-efficient. Here you can find tips on how to save even more energy when using the appliance, and how to dispose of your appliance properly.

### Saving energy

- Only preheat the appliance if this is specified in the recipe or in the tables in the operating instructions.
- Leave frozen food to defrost before placing it in the cooking compartment.

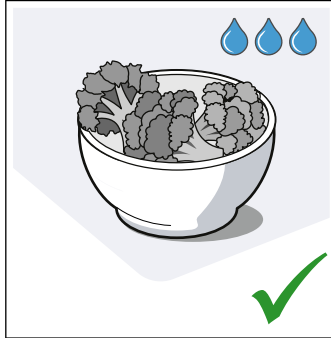
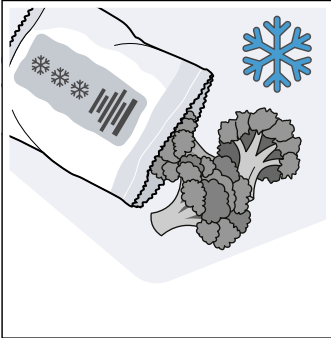

- Use baking tins that are dark-coloured, painted black or have an enamel coating. These absorb the heat particularly well.

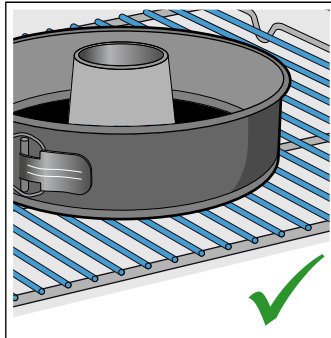
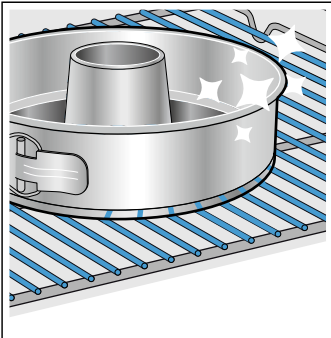

- Remove any unnecessary accessories from the cooking compartment.

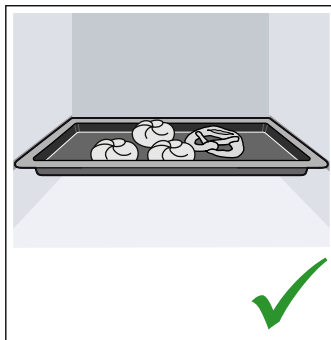
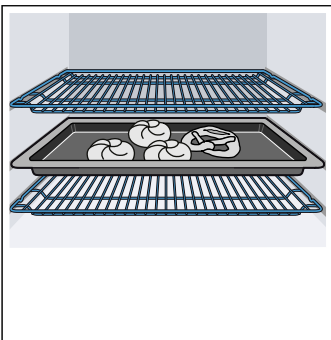

- Open the appliance door as infrequently as possible when the appliance is in use.

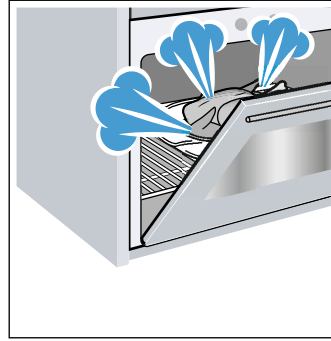

- It is best to bake several cakes one after the other. The cooking compartment stays warm. This reduces the baking time for the second cake. You can place two cake tins next to each other in the cooking compartment.

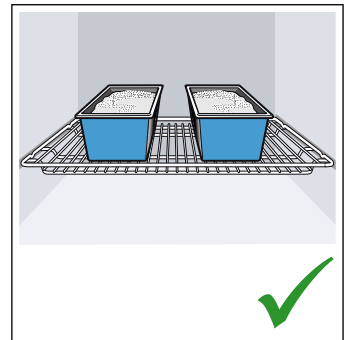
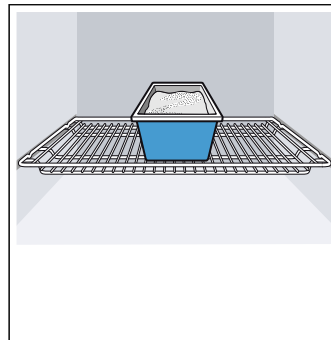

- For longer cooking times, you can switch the appliance off 10 minutes before the end of the cooking time and use the residual heat to finish cooking.

### Environmentally-friendly disposal

Dispose of packaging in an environmentally-friendly manner.



This appliance is labelled in accordance with European Directive 2012/19/EU concerning used electrical and electronic appliances (waste electrical and electronic equipment - WEEE). The guideline determines the framework for the return and recycling of used appliances as applicable throughout the EU.

# Getting to know your appliance

In this section, we will explain the indicators and controls. You will also find out about the various functions of your appliance.

**Note:** Depending on the appliance model, individual details and colours may differ.

## Control panel

You can set your appliance's various functions on the control panel. Below, you will see an overview of the control panel and the layout of the controls.

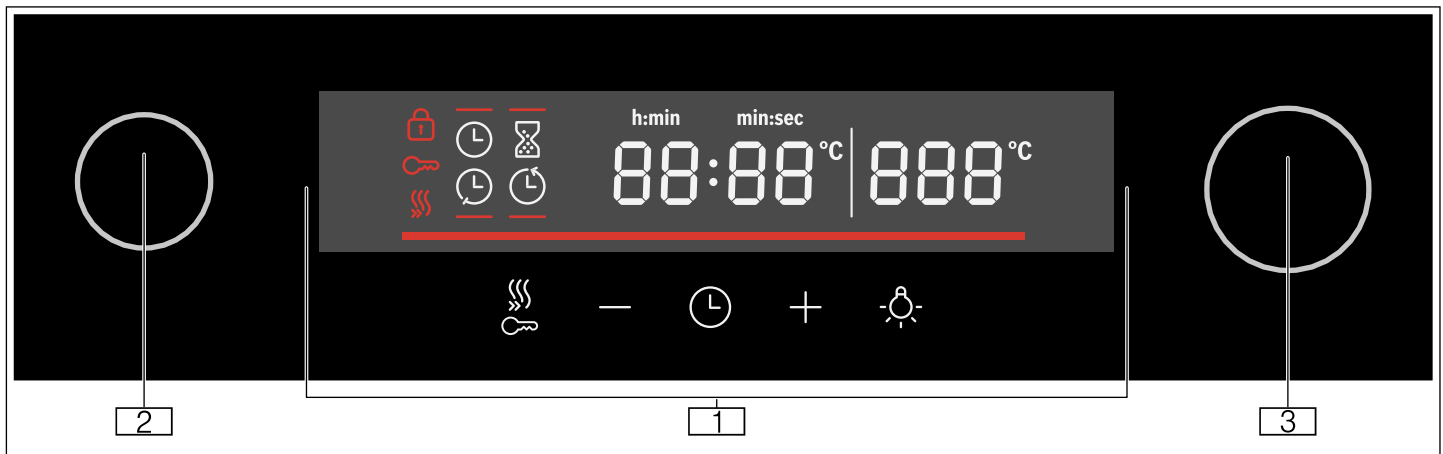

- 1 Buttons and display**  
The buttons are touch keys with sensors underneath. Simply touch a symbol to select the function.  
The display shows symbols for active functions and the time-setting options.
- 2 Function selector**  
Use the function selector to set the heating function or other functions.  
You can turn the function selector clockwise or anti-clockwise from the "Off" position.
- 3 Temperature selector**  
Use the temperature selector to set the temperature for the heating function or select the setting for other functions.  
You can also turn the temperature selector clockwise or anti-clockwise. It does not have an "Off" position.

+	Plus	Increase the setting value
☹	Lighting	Switch the interior lighting on/off
🔥	Rapid heat-up	Switch rapid heat-up on/off
🔒	Childproof lock	Activate and deactivate the childproof lock in standby mode

## Display

The display is structured so that the information can be read at a glance.

The value that you can currently set is in focus. It is displayed in white lettering with a dark background.

Symbol	Explanation
🔥	Rapid heat-up
⌚	Timer
🕒	Duration
🕒	End time
🕒	Clock time
88:88	Time
-----	Temperature indicator
🔒	Childproof lock
🔒	Door lock
888	Temperature

## Buttons

You will find a brief explanation of the various buttons below.











If a button is not operational, an audible signal will sound.

Button	Explanation
🕒	Time-setting options Set the timer ⌚, duration 🕒, end time 🕒 and clock time 🕒
-	Minus Reduce the setting value

## Types of heating and functions

Use the function selector to set the types of heating and other functions.

To make sure you always use the right type of heating to cook your food, we have explained the differences and applications below.

Heating function	Temperature/setting	Use
 "Off" position	-	In this position, the oven is switched off.
 3D hot air	50-280 °C	For cooking food on one or two levels. The fans distribute the heat from the ring-shaped heating elements in the back panel evenly around the cooking compartment.
 Air recirculation	50-280 °C	For baking cakes and baked items on one level. The fans distribute the heat from the heating elements evenly around the cooking compartment.
 Pizza setting	50-280 °C	For cooking fresh pizza and frozen products, e.g. chips or strudel. The heating elements and fans heat quickly and distribute the heat evenly around the cooking compartment.
 Defrosting	30-60 °C	For defrosting, e.g. meat, poultry, bread and cakes. The fan causes the warm air to circulate around the food.
 Bottom heating	50-280 °C	Use when you want to cook the food for a little longer. The heat is emitted only from below.
 Cleaning	Cleaning settings: 1 = low 2 = medium 3 = high	For running a cooking compartment self-cleaning programme.
 Full-surface grill	Grill settings: 1 = low 2 = medium 3 = high	For grilling flat items, such as steaks or sausages, for making toast, and for browning food. The whole area below the grill element becomes hot.
 Rotary spit	Grill settings: 1 = low 2 = medium 3 = high	Rotary spit: For roasts, rolled roasting joints and poultry
 Circulated air grill	50-280 °C	For baking or roasting meat, poultry and whole fish. The fan causes the hot air to circulate around the food.
 Gentle top/bottom heating	50-280 °C	For gently cooking selected types of food (e.g. meat, vegetables) on one level <b>without preheating</b> . This heating function is unsuitable for food that rises as it bakes (e.g. bread).
 Top/bottom heating	50-280 °C	For cakes, bakes and lean joints. Heat is emitted evenly from above and below.

**Note:** For each heating function, the appliance specifies a default temperature or level. You can accept this value or change it in the appropriate area.

## Temperature selector

Use the temperature selector to set the temperature. The temperature that has been set will be shown on the display.

**Note:** The temperature can be set in 1 degree increments up to 100 °C, and in 5 degree increments thereafter.

## Temperature indicator

The temperature indicator bars show the heating-up phases or residual heat in the cooking compartment.

Heating-up indicator	The heating-up indicator displays the rising temperature in the cooking compartment. When all bars are filled, the optimal time for placing the food in the oven has been reached. In the grill and cleaning settings, the bars are all already filled at the start. The bars are not filled for the gentle top/bottom heating heating type.
Residual heat indicator	When the appliance is switched off, the temperature indicator shows the residual heat in the cooking compartment. Once the temperature has dropped to approximately 60 °C, the indicator goes out.

## Cooking compartment functions

Some functions make your appliance easier to use. This, for example, enables the cooking compartment to be well lit and a cooling fan to prevent the appliance from overheating.

### Opening the appliance door

If you open the appliance door during an operation, the operation is paused. Operation continues to run when you close the door.

### Interior lighting

When you open the appliance door, the interior lighting switches on. If the door remains open for longer than 15 minutes, the lighting switches off again.

In most operating modes, the interior lighting will switch on as soon as the appliance is started. Once the program is complete, the lighting will switch off.

**Note:** In "Top/bottom heating gentle" mode, the interior lighting will be switched off automatically after approx. 1 minute. It can be switched on using the  button.

### Cooling fan

The cooling fan switches on and off as required. The warm air escapes above the door.

With the gentle top/bottom heating heating type, the cooling fan switches off and on more frequently to save energy.







### Caution!

Do not cover the ventilation slots, otherwise the oven will overheat.

To cool the cooking compartment more quickly after operation, the cooling fan continues to run for a certain period afterwards.

## Accessories

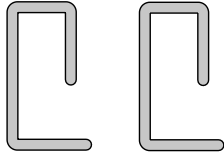
Your appliance is accompanied by a range of accessories. Here, you can find an overview of the accessories included and information on how to use them correctly.

Accessories	Description
	<b>Baking and roasting shelf</b> For cookware, cake tins, joints of meat, grilled items and frozen food.
	<b>Wire insert</b> Designed to be placed into the universal pan or the baking tray. For preparing large quantities of food.
	<b>Universal pan</b> For moist cakes, pastries, frozen meals and large roasts. The universal pan can be used to catch dripping fat when you are grilling directly on the wire rack.
	<b>Enamel baking tray</b> For tray bakes and small baked products.
	<b>Telescopic rail set</b> You can use the pull-out rails to pull the accessories out further.
	<b>Locking pins</b> For locking the hinges.
	<b>Rotary spit</b> For roasting joints of meat and large poultry. Use only in combination with the enamelled baking tray.

## Shelf positions

The baking tray and the baking and roasting shelf can be inserted into the cooking compartment at five different levels. Always push accessories in fully so that they do not touch the door panel. Make sure that you always insert the accessories into the cooking compartment the right way round.

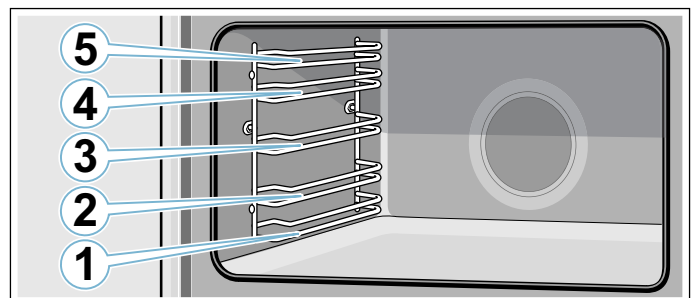

### Warning – Risk of fire!

Under no circumstances should a roasting tin, baking tray, frying pan or any other form of cookware be placed directly on the oven floor. This causes the floor of the appliance to overheat and can seriously damage the appliance.

## Locking function

The accessories can be pulled out approximately halfway before they lock in place. The locking function prevents the accessories from tilting when they are pulled out. The accessories must be inserted into the cooking compartment correctly for the tilt protection to work properly.

When inserting the wire rack, ensure that the lug **a** is at the rear and is facing downwards. The open side must be facing the appliance door and the curvature must be at the bottom (i.e. )

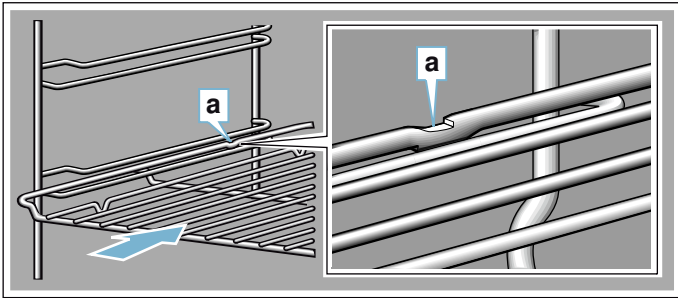

When inserting baking trays, ensure that the lug **a** is at the rear and is facing downwards. The sloping edge of the accessory **b** must be facing towards the appliance door.

Example in the picture: Universal pan

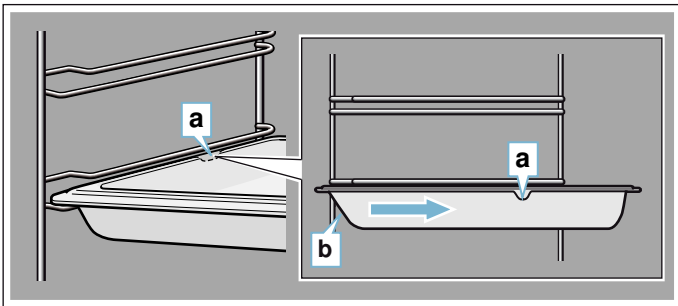

## Telescopic rail set

### Warning – Risk of burns!

The telescopic shelves become hot when the appliance is in use. Take special care not to get burnt when they are pulled out.

The pull-out rails allow you to pull accessories out completely. When inserting the adapter for the baking tray and roasting shelf, ensure that it locks into place in front of the tab on the pull-out rails.

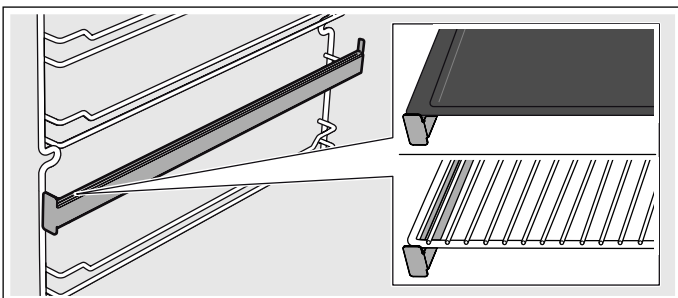

## Special accessories

You can buy accessories from the after-sales service.

Accessories	Description
<b>Enamelled baking tray</b>	For tray bakes and small baked items. After-sales service number: 11012235
<b>Universal pan</b>	For moist cakes, pastries, frozen meals and large roasts. The universal pan can be used to catch dripping fat when you are grilling directly on the wire rack. After-sales service number: 11012236
<b>Baking and roasting shelf</b>	For ovenware, cake tins, joints, grilled items, frozen meals. After-sales service number: 11012237
<b>Telescopic shelf set</b>	Telescopic shelf set for one level. After-sales service number: 12036208



## Before using for the first time

In this section, you can find out what you must do before using your oven to prepare food for the first time. Remove the appliance packaging and dispose of it appropriately.

### Setting the time on the clock

Once the appliance is connected to a power supply, **12:00** will flash on the display and the ⌚ symbol will be continuously lit. Set the time.

1. Use the **-** or **+** button to set the time.
2. Press the ⌚ button.  
**Note:** Once the period allowed for setting the clock time has elapsed, the clock time will automatically be saved.

The time has now been set.

### Baking out the oven

#### Precleaning the oven

1. Remove the accessories and the shelf supports from the cooking compartment. → *"Rails" on page 20*
2. Completely remove any leftover packaging, e.g. small pieces of polystyrene, from the cooking compartment.
3. Some parts are covered with a protective film. Remove this scratch protection film.
4. Clean the outside of the appliance with a soft, damp cloth.
5. Clean the cooking compartment with hot soapy water.

#### Heating up the oven

To remove the new cooker smell, heat up the oven when it is empty and closed.

**Note:** Make sure that there is no leftover packaging, such as polystyrene pellets, in the cooking compartment. Before heating up the appliance, wipe the smooth surfaces in the cooking compartment with a soft, damp cloth. Keep the kitchen ventilated while the appliance is heating.

1. Turn the function selector to
2. Turn the temperature selector to the maximum temperature.
3. Switch the oven off after 1 hour.

**Note:** When the appliance is heating up for the first time, you may hear crackling noises coming from the oven.

#### Recleaning the oven

1. Clean the cooking compartment with hot soapy water.
2. Refit the hook-in racks.
3. If necessary, clean the door panels. → *"Appliance door" on page 20*

### Cleaning the accessories

Before using the accessories, clean them thoroughly using a cloth and warm soapy water.

### Fitting the telescopic shelf set

Instructions on fitting the telescopic shelf set are enclosed with the set.

## Operating the appliance

### Switching the oven on and off

#### Switching on the oven

1. Use the function selector to set the heating function.  
**Note:** Each function has a default temperature or grill setting.

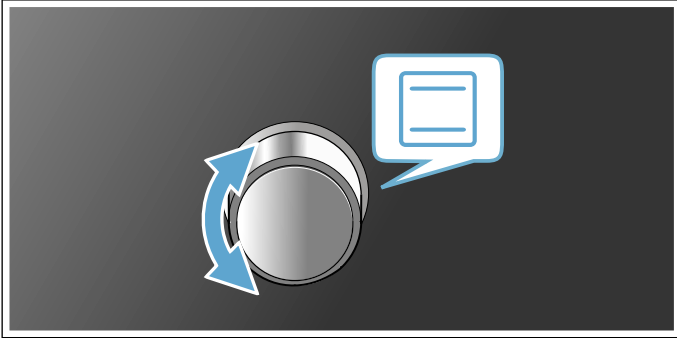

2. Use the temperature selector to alter the temperature or grill setting.

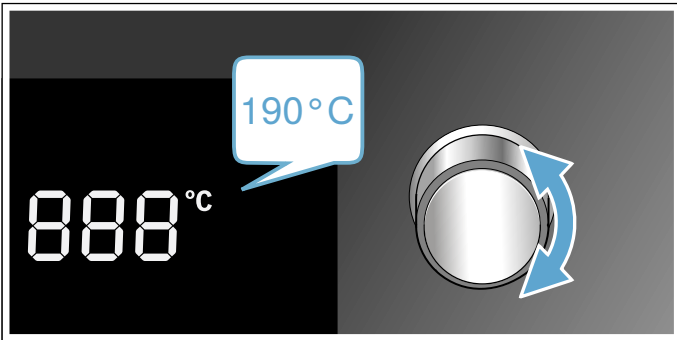

The oven will then begin to heat.

**Note:** The temperature indicator will show the current status of the heating-up phase.

#### Changing settings

The heating function and temperature or grill setting can be changed at any time using the relevant selector.

#### Switching off the oven

Turn the function selector to the "Off" position.

#### Switching on the rapid heat-up function

To heat up the cooking compartment as rapidly as possible, press the  button.

**Note:** Rapid heat-up is available for 3D hot air mode, air recirculation mode, the pizza setting and top/bottom heating.

## Rotary spit

### Preparing the rotary spit

1. Slide a retaining clip onto the rotary spit and screw on the handle.

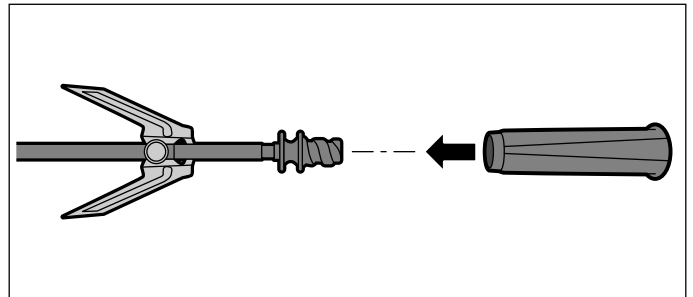

2. Place the roast as close as possible to the centre of the rotary spit.
3. Use retaining clips to secure the roast in place.
4. Use milled screws to secure the retaining clips.

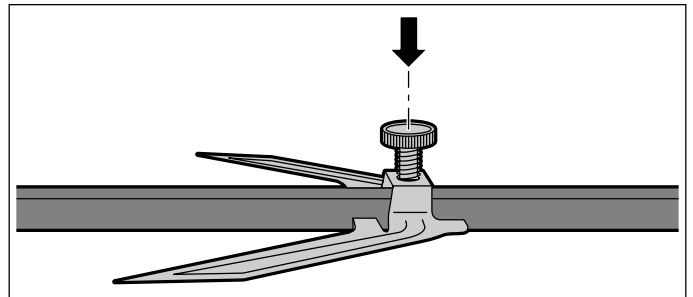

### Inserting the rotary spit

#### Warning – Risk of burns!

Never touch the hot surfaces of the cooking compartment or the heating elements. Children must be kept at a safe distance from the appliance at all times. Open the appliance door carefully. Hot steam may escape.

1. Insert the rotary spit frame into the threaded bushes

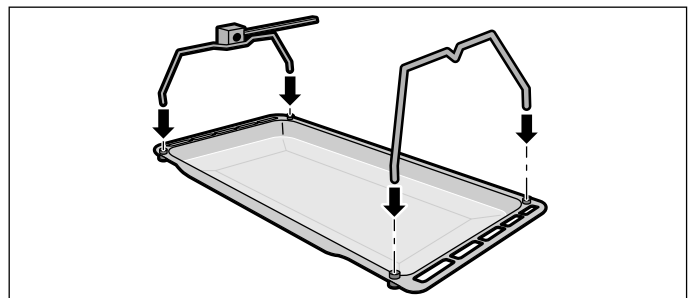

- Place the rotary spit onto the rotary spit frame and unscrew the handle.

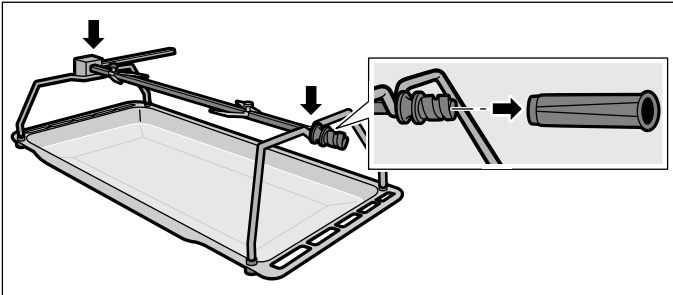

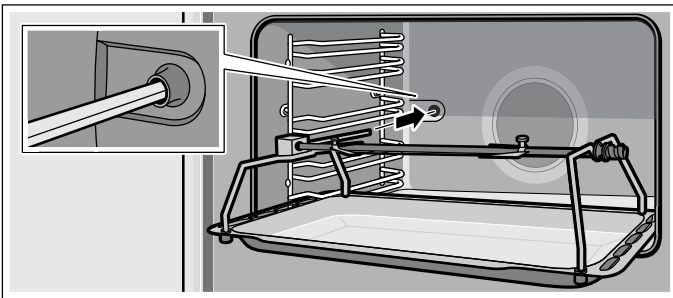

- Slide the universal pan into shelf position 1 and slide the rotary spit into the motor mount.



- Close the appliance door.

### Switching on the rotary spit

**Note:** When using the rotisserie spit, heat the oven using the  heating function. Insert the rotisserie spit before setting the  heating function.

- Turn the function selector to .
- Set the grill setting.

**Note:** Pour some water into the universal pan to catch any fat that drips out.

### Removing the rotary spit

#### **Warning – Risk of burns!**

Never touch the hot surfaces of the cooking compartment or the heating elements. Children must be kept at a safe distance from the appliance at all times. Open the appliance door carefully. Hot steam may escape.

- Opening the appliance door
- Slowly pull the universal pan until it is halfway out of the cooking compartment.
- Completely remove the universal pan from the cooking compartment and set it on the worktop.
- Screw on the handle and remove the grill spit from the grill spit frame.





### Automatic safety switch-off function

The appliance has an automatic safety cut-out function. The oven switches off automatically after 13 hours.

## Time-setting options

Your appliance has different time-setting options.



### Overview of the time-setting options

Time-setting option	Use
 Timer	The timer functions like an egg timer. It runs independently of the appliance when it is heating and of other time-setting options, and does not affect the appliance.
 Clock time	When no other function is running in the foreground, the appliance will show you the time of day on the display.
 Cooking time	Once the set cooking time has elapsed, the appliance will automatically stop heating.
 End time	Enter a cooking time and the required end time. The appliance will start up automatically so that it finishes cooking at the required time.

### Operating the electronic clock

#### Setting the timer

The timer has no effect on how the oven works. The timer duration can be set to between 30 seconds and 13 hours. The duration can be set in 30-second increments up to 10 minutes, in 1-minute increments from 10 minutes to 1 hour, and then in 5-minute increments.

- Press the  button. The  symbol will be lit.
- Use the **+** and **-** buttons to set the required duration. An audible signal will sound once the time has elapsed.

#### Notes

- To change the remaining time, press the  button. Then change the remaining time using the **+** and **-** buttons.
- To stop the timer counting down, set the remaining time to zero.





#### Switching off the signal tone

To switch the signal off, press any button or open the appliance door.

**Note:** After a short time, the audible signal will stop automatically.

### Setting the electronic clock

You can alter the clock if you need to (e.g. from summer to winter time). To do this, the oven must be switched off.



1. Press the  button.  
The  symbol will be lit.
2. Press the  button again.  
The  symbol will be lit.
3. Use the **+** and **-** buttons to set the current time.

### Setting the automatic timer

The electronic clock can be used to switch the oven on or off automatically.

#### Setting the cooking time

You can set the cooking time for your food on the appliance. This prevents the food from accidentally being cooked for too long, and means that you do not have to stop what you are doing to switch off the oven.

1. Set the type of heating and the temperature you require.  
The oven will start.
2. Press the  button twice.
3. Use the **+** and **-** buttons to set the required cooking time.  
**Note:** The cooking time can be set to between 30 seconds and 13 hours. The cooking time can be set in 1-minute increments up to 1 hour, and then in 5-minute increments.  
The  symbol will be lit.





#### The cooking time has elapsed

An audible signal will sound. The appliance will stop heating.

1. To switch the signal off, press any button or open the appliance door.  
**Note:** After a short time, the audible signal will stop automatically.
2. Turn the function selector to the "Off" position.

### Setting the end time

Baking or roasting starts for the set duration at a later time which you chose.

1. Set the type of heating and the temperature you require.  
The oven will start.
2. Press the  button twice.
3. Use the **+** and **-** buttons to set the required cooking time.  
**Note:** The cooking time can be set to between 30 seconds and 13 hours. The cooking time can be set in 1-minute increments up to 1 hour, and then in 5-minute increments.  
The  symbol will be lit.
4. Press the  button again.
5. Use the **+** and **-** buttons to set the end time.  
**Note:** When the button is first pressed, a value will be suggested on the display. This suggested value is calculated using the current time on the clock and the cooking time. This value can be changed using the **+** and **-** buttons.  
The  symbol will be lit. The display will show the end time. The appliance will now switch to standby mode.

#### The cooking time has elapsed

An audible signal will sound. The appliance will stop heating.

1. To switch the signal off, press any button or open the appliance door.  
**Note:** After a short time, the audible signal will stop automatically.
2. Turn the function selector to the "Off" position.

## Childproof lock

The oven has a childproof lock to prevent children from switching it on by accident.

**Note:** If the hob is being used, it will not be affected by the childproof lock on the oven.

### Activating the childproof lock

The appliance must be switched off.

Press and hold the  button for approx. 4 seconds.

The  symbol will appear on the display. The childproof lock has now been activated.

### Deactivating the childproof lock

Press and hold the  button for approx. 4 seconds.

The  symbol will go out on the display. The childproof lock has now been deactivated.

## Basic settings

There are various settings available to you in order to help use your appliance effectively and simply. You can change these settings as required.

### List of basic settings



Depending on the features of your appliance, not all basic settings will be available.

Basic setting	Options
<b>c01</b> Audible signal duration upon completion of a cooking time or timer duration	1 = approx. 10 seconds 2 = approx. 30 seconds* 3 = approx. 2 minutes
<b>c02</b> Amount of time until a setting is applied	1 = approx. 3 seconds* 2 = approx. 6 seconds 3 = approx. 10 seconds
<b>c03</b> Button tone that sounds when a button is touched	0 = off 1 = on*
<b>c04</b> Brightness of the display illumination	1 = dark 2 = medium* 3 = bright
<b>c05</b> Display time of day	0 = hide the time 1 = display the time*
<b>c06</b> Interior lighting on when appliance in operation	0 = no 1 = yes*
<b>c07</b> Cooling fan run-on time	1 = short* 2 = medium 3 = long 4 = extra long
<b>c08</b> Reset all values to factory settings	0 = no* 1 = yes
<b>c09</b> Activate demo mode Demo mode is provided for demonstration purposes only; the oven does not actually heat in Demo mode. Demo mode can only be activated within 5 minutes of connecting the appliance to the mains power supply.	0 = no* 1 = yes

\* Factory setting

## Changing the basic settings

The function selector must be set to the "Off" position.

1. Press and hold the  button for approx. 4 seconds. The first basic setting will appear on the display, e.g. **c011**.
2. Use the temperature selector to change the setting as required.
3. Use the **+** button to navigate to the next basic setting.
4. Use the **-** or **+** button to continue going through all the basic settings as described above, and use the temperature selector if you want to change any of these settings.
5. When you have finished, press and hold the  button again for approx. 4 seconds to confirm the settings.

This applies all the basic settings.

You can change the basic settings again at any time. Demo mode can only be activated within 5 minutes of connecting the appliance to the mains power supply.

**Note:** Your changes to the basic settings will be retained even after a power failure.

## Setting energy-saving mode

You can save energy by reducing the display brightness. You can set the display brightness under basic setting **c04**.

**Note:** This setting changes the brightness of the display while the appliance is in operation. In standby mode, the appliance automatically reduces the display brightness. The display is at its dimmest at night, between the hours of 22:00 and 05:59.

## Cleaning

With good care and cleaning, your appliance will retain its appearance and remain fully functioning for a long time to come. We will explain here how you should correctly care for and clean your appliance.

### Warning – Risk of electric shock!

Do not use any high-pressure cleaners or steam cleaners, which can result in an electric shock.

### Warning – Risk of burns!

The appliance becomes very hot. Never touch the interior surfaces of the cooking compartment or the heating elements. Always allow the appliance to cool down. Keep children at a safe distance.

## Suitable cleaning agents

Observe the following information to ensure that the different surfaces are not damaged by using the wrong type of cleaning agent.

Do not use any of the following

### on the oven:

- Any harsh or abrasive cleaning agents,
- Cleaning agents with a high concentration of alcohol,
- Hard scouring pads or sponges,
- High-pressure cleaners or steam cleaners.

Wash new sponge cloths thoroughly before use.

Area	Cleaning
<b>Appliance exterior</b>	
Stainless steel front	Hot soapy water: Clean with a dish cloth and then dry with a soft cloth.  Remove flecks of limescale, grease, starch and albumin (e.g. egg white) immediately. Corrosion can form under such flecks.  Special stainless steel cleaning products suitable for hot surfaces are available from our after-sales service or from specialist retailers. Apply a very thin layer of the cleaning product with a soft cloth.
Control panel	Hot soapy water: Clean with a dish cloth and then dry with a soft cloth.  Do not use glass cleaner or a glass scraper.
Door panels	Hot soapy water: Clean with a dish cloth and then dry with a soft cloth.  Do not use a glass scraper or a stainless steel scouring pad.
Door handle	Hot soapy water: Clean with a dish cloth and then dry with a soft cloth.  If descaler comes into contact with the door handle, wipe it off immediately. Otherwise, any stains will not be able to be removed.

Appliance interior	
Enamelled surfaces	<p>Hot soapy water or a vinegar solution: Clean with a dish cloth and then dry with a soft cloth.</p> <p>Soften baked-on food remnants with a damp cloth and soapy water. Use stainless steel wire wool or oven cleaner to remove stubborn dirt.</p> <p><b>Caution!</b> Never use oven cleaner in the cooking compartment when it is still warm. This may damage the enamel. Remove all food remnants from the cooking compartment and the appliance door before you next heat up the appliance.</p> <p>Leave the cooking compartment open to dry after cleaning it.</p> <p>It is best to use the cleaning function. → "Cleaning function" on page 19</p> <p><b>Note:</b> Food residues can cause white deposits to form. These are harmless and do not affect how the appliance works. Remove using lemon juice if required.</p>
Glass cover for the interior lighting	<p>Hot soapy water: Clean with a dish cloth and then dry with a soft cloth.</p> <p>If the cooking compartment is heavily soiled, use oven cleaner.</p>
Door panels	<p>Hot soapy water: Clean with a dish cloth and dry with a soft cloth. Do not use a glass scraper or a stainless steel scouring pad.</p> <p>It is best to clean the door panels along with the rest of the cooking compartment. → "Cleaning the cooking compartment" on page 18</p>
Door seal Do not remove.	<p>Hot soapy water: Clean with a dish cloth.</p> <p>Do not scour.</p>
Door cover	<p>made from stainless steel: Use stainless steel cleaner. Follow the manufacturers' instructions. Do not use stainless steel care products.</p> <p>made from plastic: Clean using hot soapy water and a dish cloth. Dry with a soft cloth. Do not use glass cleaner or a glass scraper. Remove the door cover for cleaning.</p>
Rails	<p>Hot soapy water: Soak and clean with a dish cloth or brush.</p>
Pull-out system	<p>Hot soapy water: Clean with a dish cloth or a brush.</p> <p>Do not remove the lubricant while the pull-out rails are pulled out – it is best to clean them when they are pushed in. Do not clean in the dishwasher.</p>
Accessories	<p>Hot soapy water: Soak and clean with a dish cloth or brush.</p> <p>If there are heavy deposits of dirt, use a stainless steel scouring pad.</p>

**Notes**

- Slight differences in colour on the front of the appliance are caused by the use of different materials, such as glass, plastic and metal.
- Shadows on the door panels, which look like streaks, are caused by reflections made by the interior lighting.
- Enamel is baked on at very high temperatures. This can cause some slight colour variation. This is normal and does not affect operation. The edges of thin trays cannot be completely enamelled. As a result, these edges can be rough. This does not impair the anti-corrosion protection.

**Keeping the appliance clean**

Always keep the appliance clean and remove dirt immediately so that stubborn deposits of dirt do not build up.

**⚠ Warning – Risk of fire!**

Loose food remnants, fat and meat juices may catch fire. Before using the appliance, remove the worst of the food remnants from the cooking compartment, heating elements and accessories.

**Tips**

- Clean the cooking compartment after each use. This will ensure that dirt cannot be baked on.
- Always remove flecks of limescale, grease, starch and albumin (e.g. egg white) immediately.
- Use the universal pan for baking very moist cakes.
- Use suitable ovenware for roasting, e.g. a roasting dish.

**Cleaning the cooking compartment**

1. Pour 0.4 litres of water into the centre of the cooking compartment floor.
2. Set the  heating function.
3. Use the temperature controller to set a temperature of 50 °C.
4. Switch off the appliance after 18 minutes.
5. Allow the appliance to cool down.
6. Clean the cooking compartment with a cloth.

**⚠ Warning – Risk of burns!**

The appliance becomes very hot. Never touch the interior surfaces of the cooking compartment or the heating elements. Always allow the appliance to cool down. Keep children at a safe distance.



## Cleaning function

Your appliance has a self-cleaning function. You can use the self-cleaning function to clean the cooking compartment.

### Pyrolytic self-cleaning

You can use "Pyrolytic self-cleaning" mode to clean the cooking compartment with no effort at all. The cooking compartment is heated up to a very high temperature. Residues from roasting, grilling and baking will burn.

Running this cleaning programme requires approximately 5-10 kilowatt hours, depending on the time set. The cleaning programme can be set to run for between 2 hours 30 minutes and 3 hours 30 minutes.

**Note:** For your safety, the cooking compartment door locks automatically. It cannot be opened again until the lock indicator light  goes out. The interior lighting remains off while the appliance is being cleaned.

### Warning

#### Risk of serious damage to health!

The appliance will become very hot during the cleaning function. The non-stick coating on baking trays and tins is destroyed and noxious gases are released. Never clean non-stick baking trays and baking tins using the cleaning function. Only clean enamelled accessories using the cleaning function.

### Warning

#### Risk of burns!

- The cooking compartment becomes extremely hot during the cleaning function. Never open the appliance door. Allow the appliance to cool down. Keep children away from the appliance.
-  The appliance becomes very hot on the outside during the cleaning function. Never touch the appliance door. Allow the appliance to cool down. Keep children at a safe distance.
- The appliance becomes very hot. Never touch the interior surfaces of the cooking compartment or the heating elements. Always allow the appliance to cool down. Keep children at a safe distance.

### Before running the cleaning function

#### Caution!

Shelf supports and pull-out rails get damaged if they are left in the cooking compartment when it is cleaned. Before you start the cleaning function, remove the shelf supports and pull-out rails from the cooking compartment.

1. Remove the shelf supports and pull-out rails from the cooking compartment.
2. Remove the worst of the food residues and remnants from the cooking compartment.
3. Clean the inside of the appliance door and along the edges of the cooking compartment in the area around the seal. Do not scrub the seal.

### Warning

#### Risk of fire!



- Loose food remnants, fat and meat juices may catch fire when the cleaning function is in progress. Before you start the cleaning function, always remove the worst of the food residues and remnants from the cooking compartment.
- The appliance will become very hot on the outside during the cleaning function. Never hang combustible objects, e.g. tea towels, on the door handle. Do not place anything against the front of the appliance. Keep children away from the appliance.

### Starting

1. Turn the function selector to the  heating function.
2. Use the temperature selector to set a cleaning setting.

Cleaning setting	Duration
1	2 hours 30 minutes
2	3 hours
3	3 hours 30 minutes

**Note:** Moving the function selector while the cleaning cycle is in progress will stop the pyrolytic self-cleaning program.

One minute after the cleaning cycle (pyrolytic self-cleaning) has begun, the oven door is locked to prevent it from being opened. The indicator light  lights up to show that this door lock has been activated. Once the door lock has been activated, it is no longer possible to select any functions. To select functions, wait until the  indicator light goes out.

**Note:** You can continue to use the timer while the pyrolytic self-cleaning program is in progress. The duration you set will have no effect on the pyrolytic self-cleaning function.

**Note:** You will not be able to use the interior lighting while the pyrolytic self-cleaning programme is in progress.

### Cancelling

To cancel a programme, turn the function selector to the "Off" position.

### Ending

Once the self-cleaning function has run through to the end, an audible signal will sound. The appliance door cannot be opened until the  symbol goes out.

### Once the cleaning function has ended

Once the cooking compartment has cooled down, use a damp cloth to wipe off the ash that has been left behind in the cooking compartment and around the appliance door.

**Note:** Very bad soiling may cause white deposits to remain on the enamel surfaces. This is residue from the food and is harmless. It does not affect performance. You can remove these residues using lemon juice if required.

## Rails

### Detaching the shelf supports

The shelf supports are each fixed to the side panels of the cooking compartment at three points.

1. Grip the front of the shelf support and pull it round to the middle of the cooking compartment. The front hook of the shelf support will come out of the hole.
2. Swing the shelf support round further and pull it out of the rear holes in the side panel.
3. Remove the shelf supports from the cooking compartment.

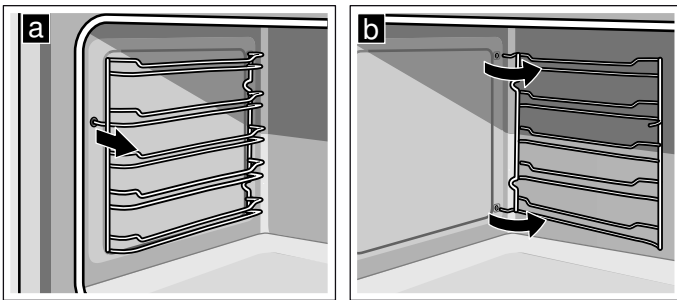

### Refitting the shelf supports

1. Insert the hooks of the shelf support into the rear holes in the side panel.
2. Push the front hook of the shelf support into the hole.

## Appliance door

With good care and cleaning, your appliance will retain its appearance and remain fully functional for a long time to come. This will tell you how to clean the appliance door.

### Removing and installing the door panels

To facilitate cleaning, you can remove the glass panels from the oven door.

#### Removing the door panels

1. Open the oven door fully.
2. Lock the two hinges on the left and right using the locking pin.

**Note:** The locking pins must be fully inserted into the holes in the hinges.

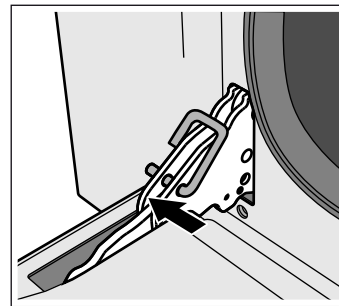

3. Use both hands to lift the bottom of the inner panel until the fastening pins come out of the holder.
4. Carefully pull the top of the inner panel out of the retaining strip and lift it to completely free the panel from the door.

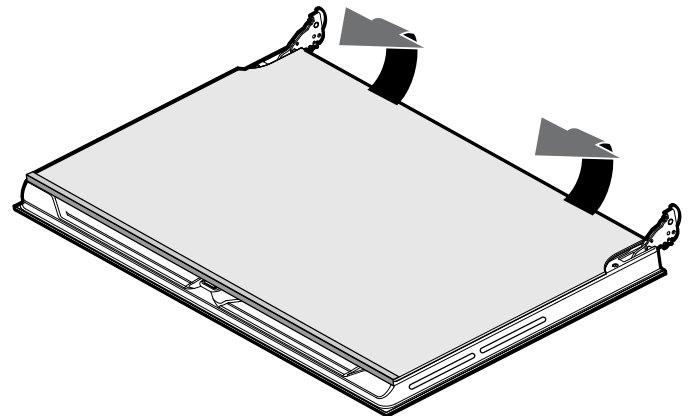

- Remove the two middle panels, along with their holders.

**Note:** The two middle panels are not fastened using retaining pins; instead, they are held in place using holders.

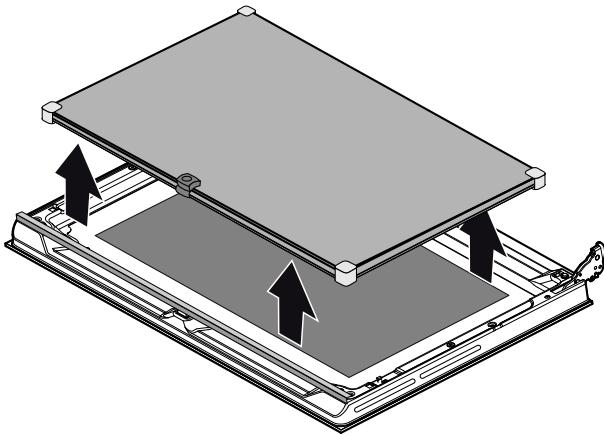

- Remove the holders to separate the two middle panels from one another.
- Clean the panels with glass cleaner and a soft cloth.

#### **⚠ Warning – Risk of injury!**

Scratched glass in the appliance door may develop into a crack. Do not use a glass scraper, sharp or abrasive cleaning aids or detergents.

#### **Fitting the door panels**

- Reinsert the two middle panels.

##### **Notes**

- You will know that you have inserted the two middle panels correctly when you can see the "Low-E" symbol on both panels.
- Make sure that the panels are seated correctly. All holders must lay flat against the outer panel.

- Reinsert the inner panel.

**Note:** The panel must first be inserted into the retaining bar. The two fastening pins must then engage in the holders provided for them.

- Remove the locking pins and close the oven door.

#### **Removing and fitting the appliance door**

If the oven is very heavily soiled, the oven door can be removed for easier cleaning. Normally, however, this is not necessary.

#### **Removing the appliance door**

- Open the oven door fully.
- Lock the two hinges on the left and right using the locking pin **(a)**.

**Note:** The locking pins must be fully inserted into the holes in the hinges.

- Take hold of the sides of the oven door with both hands and close the oven door by approx. 30° **(b)**.

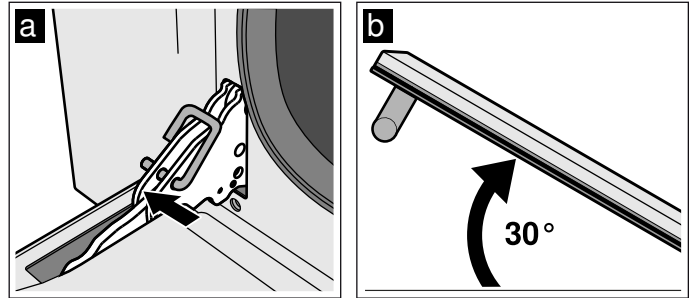

- Lift the oven door slightly and pull it out.

**Note:** Do not close the oven door fully, otherwise the hinges could become bent and the enamel could be damaged.

#### **Fitting the appliance door**

- Take hold of the sides of the oven door with both hands.
- Slide the hinges into the slots in the oven **(a)**.

**Note:** The notch at the bottom of the hinges must engage into the frame of the oven **(b)**.

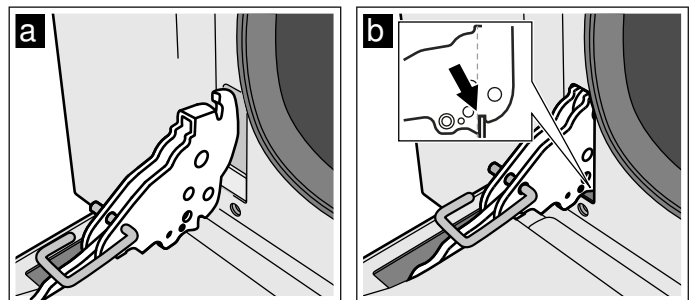

- Lower the door.
- Remove the locking pins.





#### **⚠ Warning – Risk of injury!**

If the oven door falls out accidentally or a hinge snaps shut, do not reach into the hinge. Call the after-sales service.

#### **⚠ Warning – Risk of injury!**

The door may not close properly if the door hinges have not engaged correctly. This will allow heat to escape and the parts of the appliance may become very hot. To prevent this from happening, remove the door again. Then refit the door as shown in the drawing, making sure that the groove on the underside of the hinges engages in the oven frame.

## Trouble shooting

Fault	Possible cause	Notes/remedy
The appliance does not work	The plug is not plugged into the mains	Connect the appliance to the power supply
	Power cut	Check whether other kitchen appliances are working
	The circuit breaker is faulty	Check in the fuse box to make sure that the fuse for the appliance is OK
The appliance cannot be started	The appliance door is not fully closed	Close the appliance door
	The appliance is not switched off	Switch the appliance off and back on again
<b>12:00</b> is flashing on the display	Power failure	Reset the clock.
The interior lighting is not working	Gentle top/bottom heating mode is active	In gentle top/bottom heating mode, the interior lighting is not switched on.
	The bulb is faulty	Replace the bulb.
All food that is cooked in the oven burns within an extremely short period of time.	Thermostat faulty.	Call the after-sales service.
Door panels are steamed up.	This is normal and results from differences in temperature.	Heat the appliance up to 100 °C and then switch it back off after 5 minutes.
Although the appliance is switched on, it cannot be operated; the  symbol is shown on the display	The childproof lock is activated.	Press and hold the  touch button until the  symbol goes out.
The appliance door will not open; the  symbol is shown on the display	The appliance door remains locked until the cooking compartment has cooled down.	Wait until the  symbol goes out

### Fault messages

If a fault message beginning with **Err** appears on the display, set the function selector to "Off". If the fault message does not disappear, please contact our after-sales service.

Fault message	Possible cause	Information/remedy
<b>Err1</b>	Temperature sensor failed.	Call the after-sales service.
<b>Err2</b>	The temperature in the cooking compartment is too high.	Call the after-sales service.
<b>Err4</b>	Door locking mechanism incorrectly activated.	Call the after-sales service.
<b>Err5</b>	Fan heating element faulty or not connected.	Call the after-sales service.
<b>Err6</b>	Motor faulty or not connected.	Call the after-sales service.
<b>Err8</b>	Cooling fan faulty or not connected.	Call the after-sales service.

## Replacing the oven light bulb

If the oven light bulb fails, it must be replaced. Replacement heat-resistant bulbs can be obtained from the after-sales service or from specialist retailers. Please specify the E number and FD number of your appliance. Do not use any other type of bulb.

### **⚠ Warning – Risk of electric shock!**

When replacing the cooking compartment bulb, the bulb socket contacts are live. Before replacing the bulb, unplug the appliance from the mains or switch off the circuit breaker in the fuse box.

1. Allow the cooking compartment to cool down.
2. Open the appliance door.
3. Place a tea towel in the cooking compartment to prevent damage.
4. Remove the shelf supports.
5. Remove the glass cover. To do this, open the glass cover from the front with your hand. Should you experience difficulties removing the glass cover, use a spoon to help you.
6. Remove the oven light bulb.

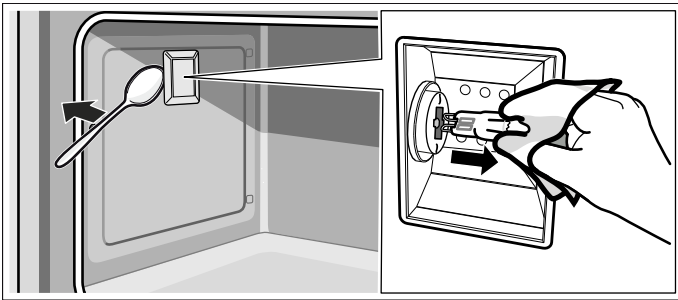

7. Replace the oven light bulb with a bulb of the same type:
  - Voltage:** 230 V;
  - Power:** 40 W;
  - Fitting:** G9;
  - Temperature resistance:** 300 °C
8. Refit the glass cover for the oven light bulb.
9. Refit the shelf supports.
10. Remove the tea towel.
11. Switch the circuit breaker back on.
12. Check that the oven lighting is working again.

## Customer service

Our after-sales service is there for you if your appliance needs to be repaired. We will always find an appropriate solution, also in order to avoid after-sales personnel having to make unnecessary visits.

### E number and FD number

When calling us, please quote the full product number (E no.) and the production number (FD no.) so that we can provide you with the correct advice. The rating plate bearing these numbers can be found when you open the appliance door.

On some appliances with a steam-assisted cooking function, you will find the rating plate behind the control panel.

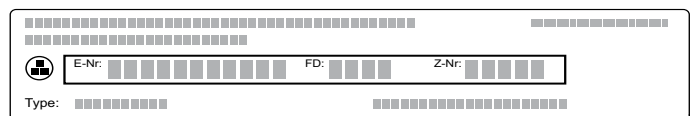

To save time, you can make a note of the numbers for your appliance and the telephone number of the after-sales service in the space below in case you need them.

E no.

FD no.

After-sales service 

Please note that a visit from an after-sales service engineer is not free of charge in the event that the appliance has been misused, even during the warranty period.

Please find the contact data of all countries in the enclosed customer service list.

### To book an engineer visit and product advice

**GB** 0344 892 8979

Calls charged at local or mobile rate.

**IE** 01450 2655

0.03 € per minute at peak. Off peak 0.0088 € per minute.

Rely on the professionalism of the manufacturer. You can therefore be sure that the repair is carried out by trained service technicians who carry original spare parts for your appliances.

## Tested for you in our cooking studio

Here, you can find a selection of dishes and the ideal settings for them. We will show you which type of heating and temperature are best suited to your dish. You will get information on suitable cooking accessories and the height at which they should be placed in the oven. You will also get tips about cookware and preparation methods.

**Note:** A lot of steam can build up in the cooking compartment when cooking food. Your appliance is very energy-efficient and radiates very little heat to its surroundings during operation. Due to the high difference in temperature between the appliance interior and the external parts of the appliance, condensation may build up on the door, control panel or adjacent kitchen cabinet panels. This is a normal physical phenomenon. Condensation can be reduced by preheating the oven or opening the door carefully.

### Table of dishes

Dish	Weight (in kg)	Shelf position	Heating function	Temperature in °C	Cooking time in minutes
Lasagne	3-4	1		220-230*	45-50
Pasta bake	3-4	1		220-230*	45-50
Joint of veal	2	2		180-190*	90-100
Joint of veal	2	2		200**	120
Pork loin	1.5	2		190-200*	90-100
Pork loin	2	2		200**	130
Sausages	1.5	3		280*	First side: 10 Second side: 5
Roast beef	1	2		200*	40-45
Roast rabbit	1.5	2		180-190*	70-80
Turkey breast	2	2		180-190*	110-120
Pork neck joint	2-3	2		180-190*	170-180
Roast chicken	1.2	2		180-190*	65-70
Pork chops	1.5	4		280*	First side: 15 Second side: 5
Spare ribs	1.5	4		280*	First side: 15 Second side: 10
Bacon	0.7	5		3*	First side: 10 Second side: 8
Fillet of pork	1.5	4		280*	First side: 12 Second side: 5
Fillet of beef	1	5		3*	First side: 10 Second side: 7
Large rainbow trout	1.2	2		150-160*	35-40
Monkfish	1.5	2		160*	60-65
Turbot	1.5	2		160*	45-50
Pizza	1	1		280*	8-9
Bread	1	2		190-200*	25-30
Focaccia	1	2		180-190*	20-25
Bundt cake	1	2		160*	55-60
Fruit flan	1	2		160*	35-40
Cheesecake	1	2		160-170*	45-55

\* Preheat

\*\* Do not preheat

Dish	Weight (in kg)	Shelf position	Heating function	Temperature in °C	Cooking time in minutes
Short-crust pastry	1	2		160-170*	35-40
Short-crust pastry	1	1		170**	65
Parfait cake	1.2	2		160*	55-60
Cream puffs	1.2	2		180*	80-90
Sponge cake	1	2		150-160*	55-60
Rice pudding	1	2		160*	55-60
Brioche	1.2	2		160*	30-35

\* Preheat  
\*\* Do not preheat

## Tips for using your appliance

Here you will find a selection of tips on ovenware and preparation methods.

### Notes

- Use the accessories provided. Additional accessories may be obtained as special accessories from specialist retailers or from the after-sales service.  
Before using the oven, remove any unnecessary accessories and ovenware from the cooking compartment.
- Always use an oven cloth or oven gloves when taking accessories or cookware out of the cooking compartment.

### Baking tips

You want to find out whether the cake is completely cooked in the middle.	Push a cocktail stick into the highest point on the cake. If the cocktail stick comes out clean with no dough residue, the cake is ready.
The cake collapses.	Next time, use less liquid. Alternatively, set the temperature to be 10 °C lower and extend the baking time. Adhere to the specified ingredients and preparation instructions in the recipe.
The cake has risen in the middle but is lower around the edge.	Only grease the base of the springform cake tin. After baking, loosen the cake carefully with a knife.
The fruit juice overflows.	Next time, use the universal pan.
Small baked items stick to one another during baking.	There should be a gap of approx. 2 cm around each item. This gives enough space for the baked items to expand well and brown on all sides.
The cake is too dry.	Set the temperature 10 °C higher and shorten the baking time.
The cake is generally too light in colour.	If the shelf position and the cookware are correct, then you should increase the temperature if necessary or extend the baking time.
The cake is too light on top, and too dark underneath.	Bake the cake one level higher in the oven the next time.
The cake is too dark on top, and too light underneath.	Bake the cake one level lower in the oven the next time. Select a lower temperature and extend the baking time.
Cakes baked in a tray or tin are too brown at the back.	Place the baking tray in the middle of the accessories, not directly against the back wall.
The whole cake is too dark.	Select a lower temperature next time and extend the baking time if necessary.
The cake is unevenly browned.	Select a slightly lower temperature. Protruding greaseproof paper can affect the air circulation. Always cut greaseproof paper to size. Ensure that the baking tin does not stand directly in front of the openings in the cooking compartment back wall. When baking small items, you should use similar sizes and thicknesses wherever possible.

You were baking on several levels. The items on the top baking tray are darker than those on the lower baking tray.	Always select hot air when baking on several levels. Baked items that are placed into the oven on trays or in baking tins/dishes at the same time will not necessarily be ready at the same time.
The cake looks good, but is not cooked properly in the middle.	Use a lower temperature and bake slightly longer; if necessary, add slightly less liquid. For cakes with a moist topping, bake the base first. Sprinkle it with almonds or breadcrumbs and then place the topping on top.
The cake cannot be turned out of the dish when it is turned upside down.	Allow the cake to cool down for 5 to 10 minutes after baking. If it still sticks, carefully loosen the cake around the edges again using a knife. Turn the cake tin upside down again and cover it several times with a cold, wet cloth. Next time, grease the baking tin/dish and sprinkle with breadcrumbs.

### Tips for Roasting and Braising

The roast is too dark and the crackling is burned in places, and/or the roast is too dry.	Check the shelf position and temperature. Select a lower temperature the next time and reduce the roasting time if necessary.
The crackling is too thin.	Increase the temperature or switch on the grill briefly at the end of the roasting time.
The roast looks good but the juices are burnt.	Next time, use a smaller roasting dish and add more liquid if necessary.
The roast looks good but the juices are too clear and watery.	Next time, use a larger roasting dish and add less liquid if necessary.
The meat gets burned during braising.	The roasting dish and lid must fit together well and close properly. Reduce the temperature and add more liquid when braising if necessary.

### Acrylamide in foodstuffs

Acrylamide is mainly produced in grain and potato products prepared at high temperatures, such as potato crisps, chips, sliced bread, bread rolls, bread or fine baked goods (biscuits, gingerbread, spiced biscuit).

Tips for keeping acrylamide to a minimum	
General	<ul style="list-style-type: none"> <li>■ Keep cooking times as short as possible.</li> <li>■ Cook food until it is golden brown, but not too dark.</li> <li>■ Large, thick pieces of food contain less acrylamide.</li> </ul>
Baking	With top/bottom heating at max. 200 °C. With hot air at max. 180 °C.
Biscuits	With top/bottom heating at max. 190 °C. With hot air at max. 170 °C. Egg or egg yolk reduces the production of acrylamide.
Oven chips	Spread out a single layer evenly on the baking tray. Cook at least 400 g at once on a baking tray so that the chips do not dry out.





## Thank you for buying a Bosch Home Appliance!

Register your new device on MyBosch now and profit directly from:

- **Expert tips & tricks for your appliance**
- **Warranty extension options**
- **Discounts for accessories & spare-parts**
- **Digital manual and all appliance data at hand**
- **Easy access to Bosch Home Appliances Service**

Free and easy registration – also on mobile phones:

**[www.bosch-home.com/welcome](http://www.bosch-home.com/welcome)**



## Looking for help? You 'll find it here.

Expert advice for your Bosch home appliances, need help with problems or a repair from Bosch experts.

Find out everything about the many ways Bosch can support you:

**[www.bosch-home.com/service](http://www.bosch-home.com/service)**

**Contact data of all countries are listed in the attached service directory.**

**Robert Bosch Hausgeräte GmbH**

Carl-Wery-Straße 34

81739 München

Germany

**[www.bosch-home.com](http://www.bosch-home.com)**



9001299250

010426