



# DRYERS

*Safety Information* ..... 3-5

***Operating Instructions***

Controls ..... 6, 7  
Features ..... 8  
Loading and Using  
the Dryer ..... 10  
Reversing the Door ..... 9  
Venting the Dryer ..... 11

***Troubleshooting Tips***

Before You Call  
For Service ..... 12, 13

***Customer Service***

Product Registration ..... 17, 18  
Service Telephone  
Numbers ..... Back Cover  
Warranty ..... 19

**Owner's Manual**

*Models Type:* 333  
453  
463  
483  
485  
2000  
3300  
4500

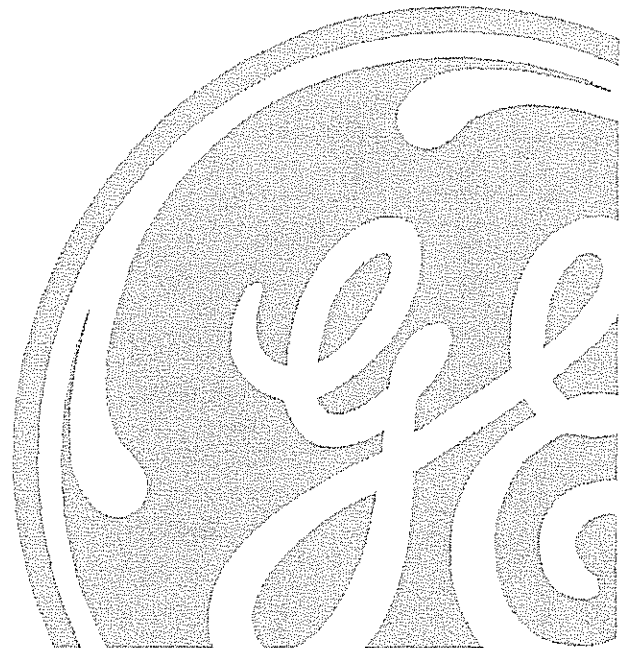

# GE & You, A Service Partnership.

Safety Instructions



## IMPORTANT!

Fill out the Consumer Product Registration Card.

**Two easy ways to register your appliance!**

- Through the internet at [www.geappliances.com](http://www.geappliances.com)
- Complete and mail the enclosed Product Registration Card

Operating Instructions



## FOR YOUR RECORDS

**Write the model and serial numbers here:**

# \_\_\_\_\_

# \_\_\_\_\_

They are on the label on the front of the dryer behind the door.



## READ THIS MANUAL

Inside you will find many helpful hints on how to use and maintain your dryer properly. Just a little preventive care on your part can save you a great deal of time and money over the life of your dryer.

Troubleshooting Tips



## PROPER VENTING

For the best drying performance the dryer needs to be properly vented. The dryer will use more energy and run longer if it is not vented to the specifications outlined in the *Venting the Dryer* section in this manual and the *Exhausting* section in the Installation Instructions.



## IF YOU NEED SERVICE

You'll find many answers to common problems in the *Before You Call For Service* section. If you review our chart of *Troubleshooting Tips* first, you may not need to call for service at all.

If you do need service, you can relax knowing help is only a phone call away. A list of toll-free customer service numbers is included in the back section. Or, **in the U.S.**, you can always call the GE Answer Center® at 800.626.2000, 24 hours a day, 7 days a week. **In Canada**, call 1-800-361-3400.

**OR**

Visit our Website at [www.GEAppliances.com](http://www.GEAppliances.com).

Customer Service

# IMPORTANT SAFETY INFORMATION. READ ALL INSTRUCTIONS BEFORE USING.

## **▲ WARNING!**

For your safety, the information in this manual must be followed to minimize the risk of fire or explosion, electric shock, or to prevent property damage, personal injury, or death.

- Do not store or use gasoline or other flammable vapors and liquids in the vicinity of this or any other appliance.
- Installation and service must be performed by a qualified installer, service agency or the gas supplier.

## **WHAT TO DO IF YOU SMELL GAS:**

- 1 Do not try to light a match, or cigarette, or turn on any gas or electrical appliance.
- 2 Do not touch any electrical switch; do not use any phone in your building.
- 3 Clear the room, building or area of all occupants.
- 4 Immediately call your gas supplier from a neighbor's phone. Follow the gas supplier's instructions carefully.
- 5 If you cannot reach your gas supplier, call the fire department.

### *California Safe Drinking Water and Toxic Enforcement Act*

This act requires the governor of California to publish a list of substances known to the state to cause cancer, birth defects or other reproductive harm and requires businesses to warn customers of potential exposure to such substances.

Gas appliances can cause minor exposure to four of these substances, namely benzene, carbon monoxide, formaldehyde and soot, caused primarily by the incomplete combustion of natural gas or LP fuels.

Properly adjusted dryers will minimize incomplete combustion. Exposure to these substances can be minimized further by properly venting the dryer to the outdoors.



## **PROPER INSTALLATION**

This dryer must be properly installed and located in accordance with the Installation Instructions before it is used. If you did not receive an Installation Instructions sheet, you can receive one by calling, toll-free, in the United States the GE Answer Center®, 800.626.2000. In Canada, call, 1-800-361-3400.

- Properly ground dryer to conform with all governing codes and ordinances. Follow details in Installation Instructions.
- Install or store where it will not be exposed to temperatures below freezing or exposed to the weather.
- Connect to a properly rated, protected and sized power supply circuit to avoid electrical overload.
- Remove all sharp packing items and dispose of all shipping materials properly.

### *Exhaust/Ducting:*

- 1 Gas dryers **MUST** be exhausted to the outside.
- 2 Exhausting electric dryers to the outside is **strongly recommended** to prevent large amounts of moisture and lint from being blown into the room.
- 3 Use only rigid metal or flexible metal 4" diameter ductwork inside the dryer cabinet or for exhausting to the outside. **USE OF PLASTIC OR OTHER COMBUSTIBLE DUCTWORK CAN CAUSE A FIRE. PUNCTURED DUCTWORK CAN CAUSE A FIRE IF IT COLLAPSES OR BECOMES OTHERWISE RESTRICTED IN USE OR DURING INSTALLATION.**

For complete details, follow the Installation Instructions.

# IMPORTANT SAFETY INFORMATION. READ ALL INSTRUCTIONS BEFORE USING.

## ▲ WARNING!



### YOUR LAUNDRY AREA

- Keep the area underneath and around your appliances free of combustible materials, (lint, paper, rags, etc.), gasoline, chemicals and other flammable vapors and liquids.
- Keep the floor around your appliances clean and dry to reduce the possibility of slipping.
- Close supervision is necessary if this appliance is used by or near children. Do not allow children to play on, with, or inside this or any other appliance.
- Keep all laundry aids (such as detergents, bleaches, etc.) out of the reach of children, preferably in a locked cabinet. Observe all warnings on container labels to avoid injury.
- Never climb on or stand on the dryer top.



### WHEN USING YOUR DRYER

- Never reach into the dryer while the drum is moving. Before loading, unloading or adding clothes, wait until the drum has completely stopped.
- Clean the lint filter before each load to prevent lint accumulation inside the dryer or in the room. **DO NOT OPERATE THE DRYER WITHOUT THE LINT FILTER IN PLACE.**
- Do not wash or dry articles that have been cleaned in, washed in, soaked in, or spotted with combustible or explosive substances (such as wax, oil, paint, gasoline, degreasers, dry-cleaning solvents, kerosene, etc.) which may ignite or explode. Do not add these substances to the wash water. Do not use or place these substances around your washer or dryer during operation.
- Do not place items exposed to cooking oils in your dryer. Items contaminated with cooking oils may contribute to a chemical reaction that could cause a clothes load to catch fire.
- Any article on which you have used a cleaning solvent or that contains flammable materials (such as cleaning cloths, mops, towels used in beauty salons, restaurants, or barber shops, etc.) must not be placed in or near the dryer until solvents or flammable materials have been removed. There are many highly flammable items used in homes such as acetone, denatured alcohol, gasoline, kerosene, some household cleaners, some spot removers, turpentine, waxes, wax removers and products containing petroleum distillates.
- The laundry process can reduce the flame retardancy of fabrics. To avoid such a result, carefully follow the garment manufacturer's care instructions.
- Do not dry articles containing rubber, plastic, or similar materials such as padded bras, tennis shoes, galoshes, bath mats, rugs, bibs, baby pants, plastic bags, pillows, etc. that may melt or burn. Some rubber materials, when heated, can under certain circumstances produce fire by spontaneous combustion.
- Do not store plastic, paper or clothing that may burn or melt on top of the dryer during operation.
- Garments labeled *Dry Away from Heat* or *Do Not Tumble Dry* (such as life jackets containing Kapok) must not be put in your dryer.
- Do not dry fiberglass articles in your dryer. Skin irritation could result from the remaining particles that may be picked up by clothing during subsequent dryer uses.
- To minimize the possibility of electric shock, unplug this appliance from the power supply or disconnect the dryer at the household distribution panel by removing the fuse or switching off the circuit breaker before attempting any maintenance or cleaning (except the removal and cleaning of the lint filter). **NOTE:** Turning the Cycle Selector knob to an **OFF** position does **NOT** disconnect the appliance from the power supply.

- Never attempt to operate this appliance if it is damaged, malfunctioning, partially disassembled, or has missing or broken parts, including a damaged cord or plug
- The interior of the machine and the exhaust duct connection inside the dryer should be cleaned at least once a year by a qualified technician. See the *Loading and Using the Dryer* section.
- If yours is a gas dryer, it is equipped with an automatic electric ignition and does not have a pilot light. **DO NOT ATTEMPT TO LIGHT WITH A MATCH.** Burns may result from having your hand in the vicinity of the burner when the automatic ignition turns on.
- You may wish to soften your laundered fabrics or reduce the static electricity in them, by using a dryer-applied fabric softener or an anti-static conditioner. We recommend you use either a fabric softener in the wash cycle, according to the manufacturer's instructions for those products, or try a dryer-added product for which the manufacturer gives written assurance on the package that their product can be safely used in your dryer. Service or performance problems caused by use of these products are the responsibility of the manufacturers of those products and are not covered under the warranty to this appliance.



### WHEN NOT USING YOUR DRYER

- Grasp the plug firmly when disconnecting this appliance to avoid damage to the cord while pulling. Place the cord away from traffic areas so it will not be stepped on, tripped over or subjected to damage.
- Do not attempt to repair or replace any part of this appliance or attempt any servicing unless specifically recommended in this Owner's Manual or in published user-repair instructions that you understand and have the skills to carry out.
- Before discarding a dryer, or removing it from service, remove the dryer door to prevent children from hiding inside.
- Do not tamper with controls.



**READ AND FOLLOW THIS SAFETY INFORMATION CAREFULLY.**  
**SAVE THESE INSTRUCTIONS**

# About the dryer control panel.

You can locate your model number on the label on the front of the dryer behind the door. Throughout this manual, features and appearance may vary from your model.

## Models Type 453 and 463

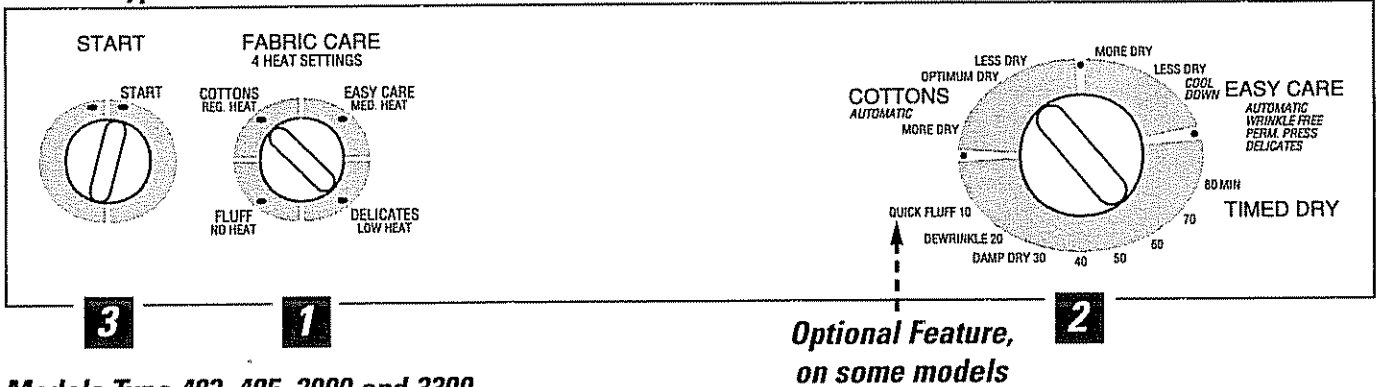

## Models Type 483, 485, 2000 and 3300

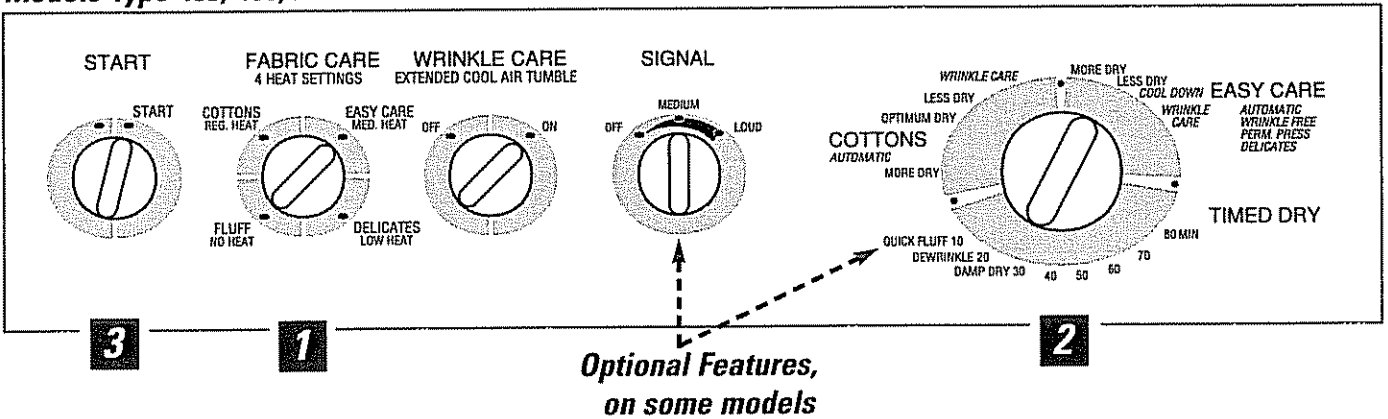

## Model Type 4500

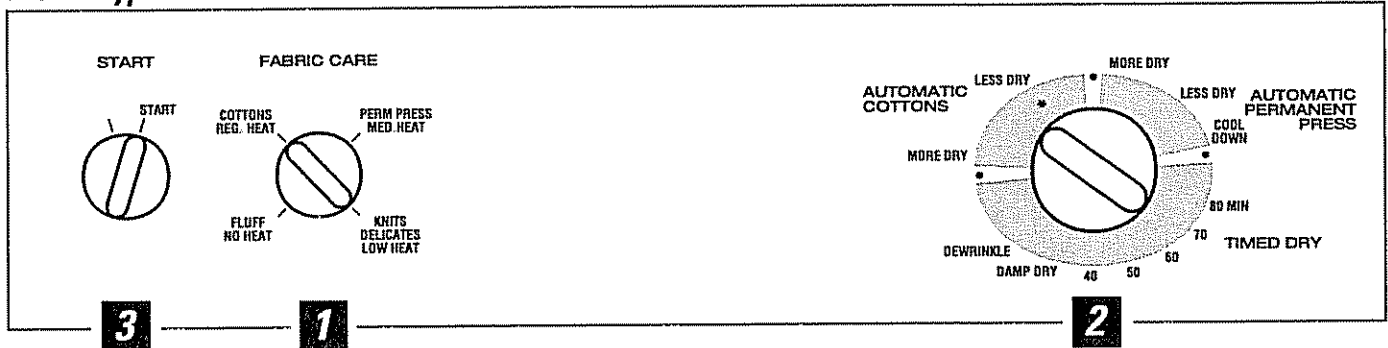

## Model Type 333

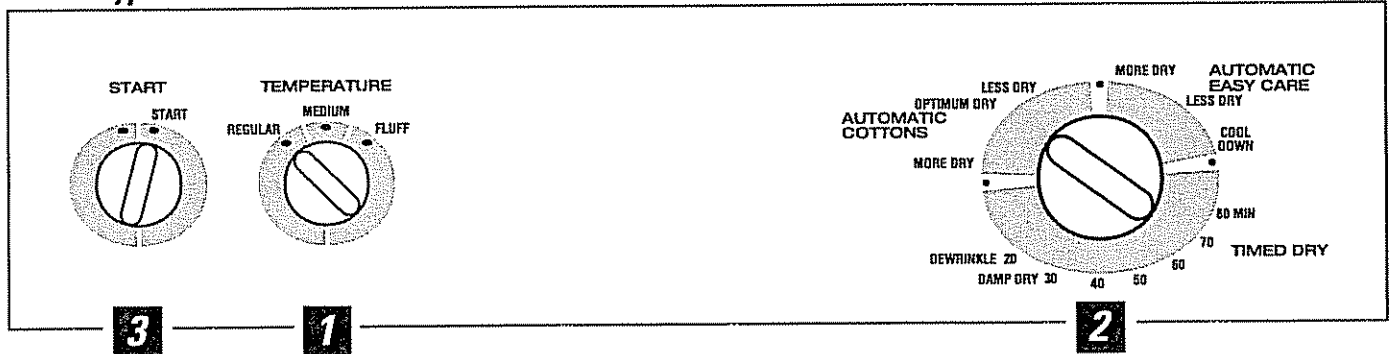

**NOTE:**

Drying times will vary according to the type of heat used (Electric, Natural or LP gas), size of load, types of fabrics, wetness of clothes and condition of exhaust ducts.





## Control Settings

**IMPORTANT:** Clean the lint filter each time you use the dryer.

### 1 Fabric Care/Temperature

**COTTONS REG. HEAT** For regular to heavy cottons

**EASY CARE MED. HEAT** For synthetics, blends, delicates and items labeled *permanent press*.

**DELICATES LOW HEAT** On some models For delicates, synthetics and items labeled *tumble dry low*.

**FLUFF NO HEAT** For fluffing items without heat Use the **TIMED DRY** cycle

Automatic cycles automatically determine fabric dryness. Select **MORE DRY** for heavier fabrics, **LESS DRY** for lighter fabrics. Timed cycles run for a selected time.

### 2 Drying Cycles

**COTTONS** For cottons and most linens. For most loads select **OPTIMUM DRY** (on some models) or select the Preferred Regular Setting marked with an \*

**EASY CARE/ PERMANENT PRESS** For wrinkle-free, permanent press and delicate items, and knits

**TIMED DRY** Set the Cycle Selector at the desired drying time

**DAMP DRY** For leaving items partially dry.

**DEWRINKLE** For removing wrinkles from items that are clean and dry or that are very lightly damp

**QUICK FLUFF** For freshening or fluffing up already dry clothing, fabrics, linens, and pillows Use with **FLUFF NO HEAT** Provides 10 minutes of no heat tumbling

**3 Start**— Close the dryer door. Select **START**. Opening the door during operation will stop the dryer. To restart the dryer, close the door and select **START** to complete the cycle.

## About your dryer features.

### WRINKLE CARE EXTENDED COOL AIR TUMBLE

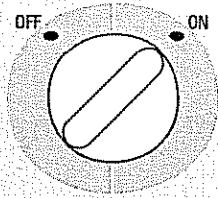

#### Wrinkle Care Option—On some models

Use this option to minimize the wrinkles in clothes. It provides approximately 15 minutes of no-heat tumbling after the clothes are dry.

This option can only be used with the Automatic cycles.

If you have a Cycle Signal knob and you select the **WRINKLE CARE** option, a signal will sound at the end of the drying time and several times during the **WRINKLE CARE** cycle. This will remind you that it is time to remove the clothes.

### SIGNAL

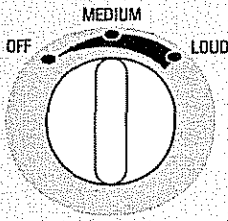

#### Cycle Signal Option—On some models

This signal will sound just before the end of the cycle to remind you to remove the clothes. On some models the signal sound level cannot be adjusted.

If you selected the **WRINKLE CARE** option the signal will sound at the end of the drying time and will sound several times during the **WRINKLE CARE** cycle. This will remind you that it is time to remove the clothes.

#### NOTE:

- Remove garments promptly at the sound of the signal. Place clothes on hangers so wrinkles won't set in.
- Use the Cycle Signal especially when drying fabrics like polyester knits and permanent press. These fabrics should be removed so wrinkles won't set in.

#### Automatic Cycle Signal—On some models

At the end of each cycle there is approximately 15 minutes of no-heat tumbling after the laundry is dry.

A reminder signal will sound periodically during this time to remind you to remove the laundry.

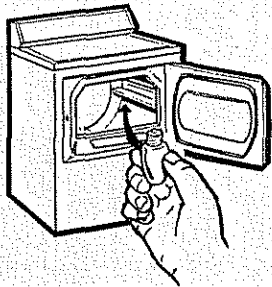

#### Drum Lamp—On some models

Before replacing the light bulb, be sure to unplug the dryer power cord or disconnect the dryer at the household distribution panel by removing the fuse or switching off the circuit breaker. Reach above dryer opening from inside the drum. Remove the bulb and replace with the same size bulb.

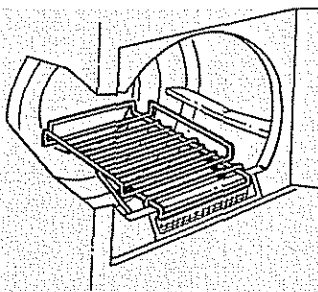

#### Drying Rack—On some models

A handy drying rack may be used for drying articles such as stuffed toys, pillows or washable sweaters.

Hook the rack over the lint filter so the rack extends into the dryer drum.

#### NOTE:

- The drying rack must be used with the **TIMED CYCLE**.
- Do not use this drying rack when there are other clothes in the dryer.

### SensorDry

#### SensorDry—On some models

This feature is only activated in the automatic cycles.

As the clothes tumble they touch a large sensor. The **SensorDry** feature will stop the heating cycle as soon as the clothes have reached the selected dryness.

# About reversing the door.

## Reversing the Door

### Tools needed

- Standard #2 Phillips screwdriver
- Tape-tipped putty knife
- Needle-nosed pliers

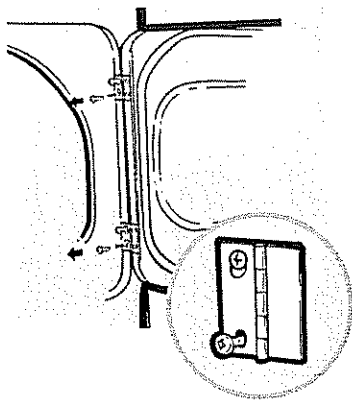

- 1 Open the door and remove the filler plugs opposite the hinges. With the door completely open, remove the bottom screw from each hinge on the dryer face. Insert these screws about half way into the **TOP** holes, for each hinge, on the opposite side (where you removed the filler plugs). Apply firm pressure to get the screw started in untapped holes.

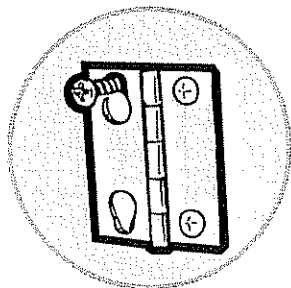

- 2 Loosen top screw from each hinge on the dryer face half way. With one hand holding the top of the door and the other hand holding the bottom, remove the door from the dryer by lifting it **UP** and **OUT**.

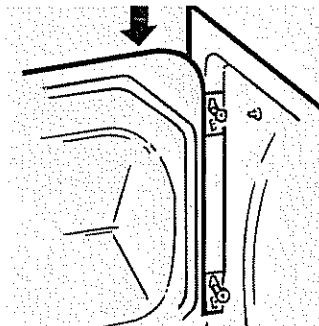

- 3 Rotate the door 180°. Insert it on the opposite side of the opening by moving the door **IN** and **DOWN** until the top hinge and the bottom hinge are resting on the top screws inserted in step 1.

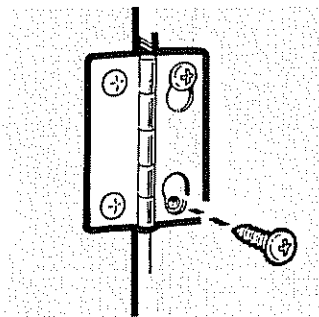

- 4 Remove the remaining screws from the side of the opening from which the door was removed. With these screws secure each hinge at the bottom. Tighten the two top screws of each hinge. Reinsert the plastic plugs on the side from which the door was removed.



**Loading and using the dryer.** Always follow the fabric manufacturer's care label when laundering.



**Sorting and Loading Hints**

As a general rule, if clothes are sorted properly for the washer, they are sorted properly for the dryer.

Do not add fabric softener sheets once the load has become warm. They may cause fabric softener stains. Bounce® Fabric Conditioner Dryer Sheets have been approved for use in all GE Dryers when used in accordance with the manufacturer's instructions

**Do not overload.** This wastes energy and causes wrinkling

**Do not dry the following items:** fiberglass items, woolens, rubber-coated items, plastics, items with plastic trim and foam-filled items.



**Care and Cleaning of the Dryer**

**The Exterior:** Wipe or dust any spills or washing compounds with a damp cloth. Dryer control panel and finishes may be damaged by some laundry pretreatment soil and stain remover products. Apply these products away from the dryer. The fabric may then be washed and dried normally. Damage to your dryer caused by these products is not covered by your warranty.

**The Lint Filter:** Clean the lint filter before each use. Moisten your fingers and reach into the filter opening. Run your fingers across the filter. Have a qualified technician vacuum the lint from the dryer once a year.

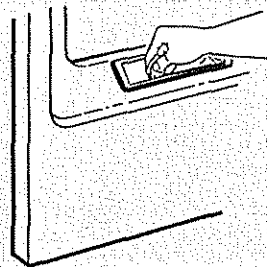

**The Exhaust Duct:** Inspect and clean the exhaust ducting at least once a year to prevent clogging. A partially clogged exhaust can lengthen the drying time.

Follow these steps:

- 1 Turn off electrical supply by disconnecting the plug from the wall socket.
- 2 Disconnect the duct from the dryer.
- 3 Vacuum the duct with the hose attachment and reconnect the duct.

**The Exhaust Hood:** Check with a mirror that the inside flaps of the hood move freely when operating. Make sure that there is not wildlife (birds, insects, etc.) nesting inside the duct or hood.



**Fabric Care Labels**

Below are fabric care label "symbols" that affect the clothing you will be laundering.

**WASH LABELS**

<b>Machine wash cycle</b>						
	Normal	Permanent Press/ wrinkle resistant	Gentle/ delicate	Hand wash	Do not wash	Do not wring
<b>Water temperature</b>						
	Hot (50°C/120°F)		Warm (40°C/105°F)		Cold/cool (30°C/85°F)	

**BLEACH LABELS**

<b>Bleach symbols</b>			
	Any bleach (when needed)	Only non-chlorine bleach (when needed)	Do not bleach

**DRY LABELS**

<b>Tumble dry</b>						
	Dry	Normal	Permanent Press/ wrinkle resistant	Gentle/ delicate	Do not tumble dry	Do not dry fused with do not wash
<b>Heat setting</b>						
	High	Medium	Low	No heat/air		
<b>Special instructions</b>						
	Line dry/ hang to dry	Drip dry	Dry flat	In the shade		



## Venting the Dryer

For the best drying performance the dryer needs to be properly vented. *The dryer will use more energy and run longer if it is not vented to the below specifications. Carefully follow the details on Exhausting in the Installation Instructions.*

- Use only rigid metal or flexible metal 4" diameter ductwork inside the dryer cabinet or for exhausting to the outside.
- Do not use plastic or other combustible ductwork.
- Use the shortest length possible.
- Do not crush or collapse.
- Avoid resting the duct on sharp objects.
- **Venting must conform to local building codes.**

**Correct Venting**

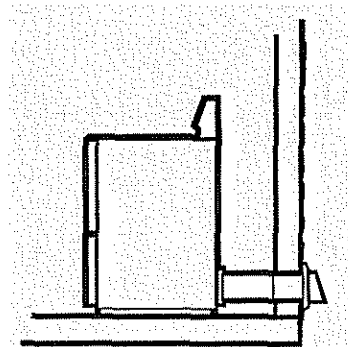
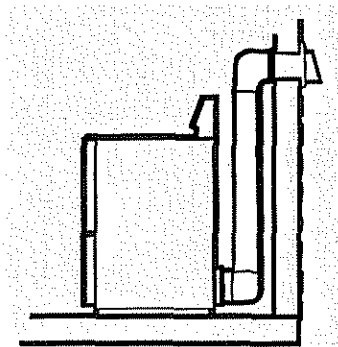

**Incorrect Venting**

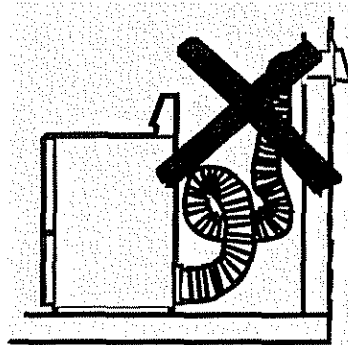
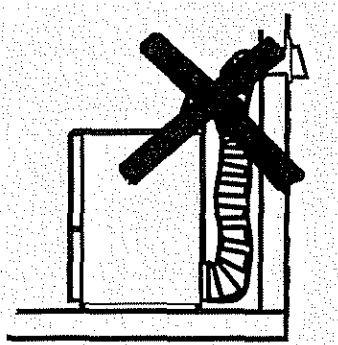

## Before you call for service...



**Troubleshooting Tips**  
Save time and money! Review the charts on the following pages first and you may not need to call for service.

<b>Problem</b>	<b>Possible Causes</b>	<b>What To Do</b>
<b>Dryer doesn't start</b>	Dryer is unplugged	<ul style="list-style-type: none"> <li>• Make sure the dryer plug is pushed completely into the outlet.</li> </ul>
	Fuse is blown/circuit breaker is tripped	<ul style="list-style-type: none"> <li>• Check the house fuse/circuit breaker box and replace fuse or reset breaker. <b>NOTE:</b> Most electric dryers use two fuses/breakers.</li> </ul>
<b>Dryer doesn't heat</b>	Fuse is blown/circuit breaker is tripped, the dryer may tumble but not heat	<ul style="list-style-type: none"> <li>• Check the house fuse/circuit breaker box and replace fuse or reset breaker.</li> </ul>
	Gas service is off	<ul style="list-style-type: none"> <li>• Make sure gas shutoff at dryer and main shutoff are fully open.</li> </ul>
<b>Dryer shakes or makes noise</b>	Some shaking/noise is normal. Dryer may be sitting unevenly	<ul style="list-style-type: none"> <li>• Move dryer to an even floor space, or adjust leveling legs as necessary until even.</li> </ul>
<b>Greasy spots on clothes</b>	Improper use of fabric softener	<ul style="list-style-type: none"> <li>• Follow directions on fabric softener package.</li> </ul>
	Drying dirty items with clean ones	<ul style="list-style-type: none"> <li>• Use your dryer to dry only clean items. Dirty items can stain clean items and the dryer.</li> </ul>
	Clothes were not completely clean	<ul style="list-style-type: none"> <li>• Sometimes stains which cannot be seen when the clothes are wet <i>appear</i> after drying. Use proper washing procedures before drying.</li> </ul>
<b>Lint on clothes</b>	Lint filter is full	<ul style="list-style-type: none"> <li>• Clean lint screen before each load.</li> </ul>
	Improper sorting	<ul style="list-style-type: none"> <li>• Sort lint producers (like chenille) from lint collectors (like corduroy).</li> </ul>
	Static electricity can attract lint	<ul style="list-style-type: none"> <li>• See suggestions in this section under <b>STATIC</b>.</li> </ul>
	Overloading	<ul style="list-style-type: none"> <li>• Separate large loads into smaller ones.</li> </ul>
	Paper, tissue, etc. left in pockets	<ul style="list-style-type: none"> <li>• Empty all pockets before laundering clothes.</li> </ul>
<b>Static occurs</b>	No fabric softener was used	<ul style="list-style-type: none"> <li>• Try a fabric softener.</li> <li>• Bounce® Fabric Conditioner Dryer Sheets have been approved for use in all GE Dryers when used in accordance with the manufacturer's instructions.</li> </ul>
	Overdrying	<ul style="list-style-type: none"> <li>• Try a fabric softener.</li> <li>• Adjust controls for less drying.</li> </ul>
	Synthetics, permanent press and blends can cause static	<ul style="list-style-type: none"> <li>• Try a fabric softener.</li> </ul>
<b>Inconsistent drying times</b>	Type of heat	<ul style="list-style-type: none"> <li>• Automatic drying times will vary according to the type of heat used (electric, natural or LP gas), size of load, types of fabrics, wetness of clothes and condition of exhaust ducts.</li> </ul>

<b>Problem</b>	<b>Possible Causes</b>	<b>What To Do</b>
<b>Clothes take too long to dry</b>	<b>Improper sorting</b>	<ul style="list-style-type: none"> <li>• Separate heavy items from lightweight items (generally, a well-sorted washer load is a well-sorted dryer load).</li> </ul>
	<b>Large loads of heavy fabrics (like beach towels)</b>	<ul style="list-style-type: none"> <li>• Large, heavy fabrics contain more moisture and take longer to dry. Separate large, heavy fabrics into smaller loads to speed drying time.</li> </ul>
	<b>Controls improperly set</b>	<ul style="list-style-type: none"> <li>• Match control settings to the load you are drying.</li> </ul>
	<b>Lint filter is full</b>	<ul style="list-style-type: none"> <li>• Clean lint filter before every load.</li> </ul>
	<b>Improper or obstructed ducting</b>	<ul style="list-style-type: none"> <li>• Check installation instructions for proper ducting/venting.</li> <li>• Make sure ducting is clean, free of kinks and unobstructed.</li> <li>• Check to see if outside wall damper operates easily.</li> <li>• Check the Installation Instructions to make sure the dryer venting is correct.</li> </ul>
	<b>Blown fuses or tripped circuit breaker</b>	<ul style="list-style-type: none"> <li>• Replace fuses or reset circuit breakers. Since most dryers use 2 fuses/breakers, make sure both are operating.</li> </ul>
	<b>Overloading/combining loads</b>	<ul style="list-style-type: none"> <li>• Do not put more than one washer load in the dryer at a time.</li> </ul>
<b>Clothes are wrinkled</b>	<b>Underloading</b>	<ul style="list-style-type: none"> <li>• If you are drying only one or two items, add a few items to ensure proper tumbling.</li> </ul>
	<b>Overdrying</b>	<ul style="list-style-type: none"> <li>• Select a shorter drying time.</li> <li>• Remove items while they still hold a slight amount of moisture.</li> </ul>
<b>Clothes shrink</b>	<b>Letting items sit in dryer after cycle ends</b>	<ul style="list-style-type: none"> <li>• Remove items when cycle ends and fold or hang immediately.</li> </ul>
	<b>Some fabrics will naturally shrink when washed. Others can be safely washed, but will shrink in the dryer</b>	<ul style="list-style-type: none"> <li>• To avoid shrinkage, follow garment care labels exactly.</li> <li>• Some items may be pressed back into shape after drying.</li> <li>• If you are concerned about shrinkage in a particular item, do not machine wash or tumble dry it.</li> </ul>



**Notes.**

---

<b>Customer Service</b>	<b>Troubleshooting Tips</b>	<b>Operating Instructions</b>	<b>Safety Instructions</b>
-------------------------	-----------------------------	-------------------------------	----------------------------

**Notes.**

---

**Safety Instructions**

**Operating Instructions**

**Troubleshooting Tips**

**Customer Service**



**Notes.**

---

<b><i>Customer Service</i></b>	<b><i>Troubleshooting Tips</i></b>	<b><i>Operating Instructions</i></b>	<b><i>Safety Instructions</i></b>
--------------------------------	------------------------------------	--------------------------------------	-----------------------------------



## GE Service Protection Plus™

GE, a name recognized worldwide for quality and dependability, offers you Service Protection Plus™—comprehensive protection on all your appliances—**No Matter What Brand!**

**Benefits Include:**

- Backed by GE
- All brands covered
- Unlimited service calls
- All parts and labor costs included
- No out-of-pocket expenses
- No hidden deductibles
- One 800 number to call

***We'll Cover Any Appliance.  
Anywhere. Anytime.\****

You will be completely satisfied with our service protection or you may request your money back on the remaining value of your contract. No questions asked. It's that simple.

Protect your refrigerator, dishwasher, washer and dryer, range, TV, VCR and much more—**any brand!** Plus there's no extra charge for emergency service and low monthly financing is available. Even icemaker coverage and food spoilage protection is offered. You can rest easy, knowing that all your valuable household products are protected against expensive repairs.

Place your confidence in GE and call us in the U.S. toll-free at **800-626-2224** for more information.

\*All brands covered, up to 20 years old, in the continental U.S.

 Cut here

Please place in envelope and mail to:

***General Electric Company***  
**Warranty Registration Department**  
**P.O. Box 32150**  
**Louisville, KY 40232-2150**

# Consumer Product Ownership Registration

Dear Customer:

Thank you for purchasing our product and thank you for placing your confidence in us. We are proud to have you as a customer!

Follow these three steps to protect your new appliance investment:

# 1

Complete and mail your Consumer Product Ownership Registration today. Have the peace of mind of knowing we can contact you in the unlikely event of a safety modification.

# 2

After mailing the registration below, store this document in a safe place. It contains information you will need should you require service. Our service number is 800 GE CARES (800-432-2737).

# 3

Read your Owner's Manual carefully. It will help you operate your new appliance properly. If you have questions, or need more information, call the GE Answer Center® 800.626.2000.

Model Number

Serial Number

**Important: If you did not get a registration card with your product, detach and return the form below to ensure that your product is registered, or register online at [www.GEAppliances.com](http://www.GEAppliances.com).**

 Cut here

## Consumer Product Ownership Registration



Model Number

Serial Number

Mr.  Ms.  Mrs.  Miss

First Name

Last Name

Street Address

Apt. #

E-mail Address

City

State

Zip Code

Date Placed  
in Use  
Month

Day

Year

Phone  
Number

Occasionally, we may allow selected companies to send you information.

Check here if you do not want this information.



**GE Appliances**

General Electric Company  
Louisville, Kentucky  
[www.GEAppliances.com](http://www.GEAppliances.com)

# GE Dryer Warranty (For customers in the U.S.).



All warranty service provided by our Factory Service Centers, or an authorized Customer Care<sup>®</sup> technician. For service, call 800-GE-CARES.

## For The Period Of: GE Will Replace:

### One Year

From the date of the original purchase

**Any part** of the dryer which fails due to a defect in materials or workmanship. During this **full one-year warranty**, GE will also provide, **free of charge**, all labor and in-home service to replace the defective part.

### Five Years

From the date of the original purchase

**Any extra large or super capacity dryer drum** which fails due to a defect in materials or workmanship. During this **additional four-year limited warranty**, you will be responsible for any labor or in-home service costs.

## What GE Will Not Cover:

- Service trips to your home to teach you how to use the product.
- Replacement of house fuses or resetting of circuit breakers.
- Improper installation.
- Damage to the product caused by accident, fire, floods or acts of God.
- Failure of the product if it is abused, misused, or used for other than the intended purpose or used commercially.
- Incidental or consequential damage to personal property caused by possible defects with this appliance.

*This warranty is extended to the original purchaser and any succeeding owner for products purchased for home use within the USA. In Alaska, the warranty excludes the cost of shipping or service calls to your home.*

*Some states do not allow the exclusion or limitation of incidental or consequential damages. This warranty gives you specific legal rights, and you may also have other rights which vary from state to state. To know what your legal rights are, consult your local or state consumer affairs office or your state's Attorney General.*

**Warrantor: General Electric Company, Louisville, KY 40225**

## Service Telephone Numbers.



### GE Answer Center® In the U.S.: 800.626.2000

The GE Answer Center® is open 24 hours a day, 7 days a week.

**In Canada**, contact: Manager, Consumer Relations, Camco Inc., 1 Factory Lane, Suite 310, Moncton, N.B., E1C 9M3.

**OR**

Visit our Website at: [www.GEAppliances.com](http://www.GEAppliances.com)



### In-Home Repair Service In the U.S.: 800-432-2737

Expert GE repair service is only a phone call away.

**In Canada**, call 1-800-361-3400.

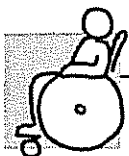

### Special Needs Service In the U.S.: 800.626.2000

GE offers, free of charge, a brochure to assist in planning a barrier-free kitchen for persons with limited mobility. **In the U.S.**, call 800-TDD-GEAC (800-833-4322).

**In Canada**, contact: Manager, Consumer Relations, Camco Inc., 1 Factory Lane, Suite 310, Moncton, N.B., E1C 9M3.



### Service Contracts In the U.S.: 800-626-2224

Purchase a GE service contract while your warranty is still in effect and you'll receive a substantial discount. GE Consumer Service will still be there after your warranty expires.

**In Canada**, call 1-800-461-3636.

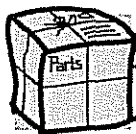

### Parts and Accessories In the U.S.: 800-626-2002

Individuals qualified to service their own appliances can have parts or accessories sent directly to their homes (VISA, MasterCard and Discover cards are accepted).

**Instructions contained in this manual cover procedures to be performed by any user. Other servicing generally should be referred to qualified service personnel. Caution must be exercised, since improper servicing may cause unsafe operation.**

Please consult your yellow pages for your local Camco number.



### Service Satisfaction

If you are not satisfied with the service you receive from GE:

**First**, contact the people who serviced your appliance.

**Next**, if you are still not pleased, **in the U.S.**, write all the details—including your phone number—to: Manager, Customer Relations, GE Appliances, Appliance Park, Louisville, KY 40225; or, **in Canada**, to Director, Consumer Relations, Camco Inc., 1 Factory Lane, Suite 310, Moncton, N.B., E1C 9M3.