

**PYE/G2000****7 Cycle Auto Dry Dryer**

# USER'S GUIDE

Congratulations on your purchase of a Performa dryer! Your satisfaction is very important to us.

**Read this manual for best results.** It contains instructions to acquaint you with proper operating instructions and maintenance.

**Save time and money.** If something should go wrong, we suggest consulting the "Before You Call" section in the back of the book. It is designed to help you solve basic problems before consulting a service technician.

Should you have any questions about using your Performa dryer, write to us. Be sure to provide the model and serial numbers.

Maytag Consumer Information  
403 W. 4th St. N.  
Newton, Iowa 50208  
(515) 791-8911  
(Mon.-Fri., 8am-5pm Central Time)  
Internet: <http://www.maytag.com>

## **Table of Contents**

<b>Safety Instructions . . . . .</b>	<b>1-2</b>
<b>Controls at a Glance . . . . .</b>	<b>3-4</b>
<b>Operating Tips . . . . .</b>	<b>5</b>
<b>Care and Cleaning . . . . .</b>	<b>5</b>
<b>Dryer Exhaust Tips . . . . .</b>	<b>6</b>
<b>Before You Call . . . . .</b>	<b>Back Page</b>

# Important Safety Instructions

**⚠ WARNING:** To reduce the risk of fire, explosion, electric shock, or personal injury when using your dryer follow basic safety precautions, including the following:

**⚠ WARNING:** For your safety, the information in this manual must be followed to minimize the risk of fire or explosion or to prevent property damage, personal injury or death.

- Do not store or use gasoline or other flammable vapors and liquids in the vicinity of this or any other appliance.

## WHAT TO DO IF YOU SMELL GAS

- Do not try to light any appliance.
- Do not touch any electrical switch; do not use any phone in your building.
- Clear the room, building or area of all occupants.
- Immediately call your gas supplier from a neighbors phone. Follow the gas supplier's instructions.
- If you cannot reach your gas supplier, call the fire department.

**Installation and service must be performed by a qualified installer, service agency or the gas supplier.**

1. Read all instructions before using the dryer. Retain all instructions for future reference.
2. Properly install and locate in accordance with the Installation Instructions.

Install or store dryer where it will NOT be exposed to the weather.

Connect to a properly rated, protected, and sized power supply circuit. See Electrical Requirements.

Have a qualified service technician install your dryer.

The dryer must be properly grounded – see Installation Instructions.

Should anyone get an electric shock from the dryer, disconnect electrical power. DO NOT operate until it has been repaired by a qualified service technician.

3. To prevent injury to children:

Do not allow children to play inside, on, or with the dryer.

Close supervision of children is necessary when using the dryer.

When children are mature enough, instruct them in the safe, correct use of the dryer.

Destroy the carton and plastic bags after unpacking the dryer.

Remove the door to the drying compartment before the dryer is removed from service or discarded.

4. Do NOT tamper with the operating controls.
5. Do not reach into the dryer if the drum is moving. If the drum does not stop moving when the door is opened, disconnect the electrical power to the dryer. Do not operate the dryer until it has been repaired by a qualified service technician.
6. To prevent personal injury and damage to the dryer, do not repair or replace any part of the dryer or attempt any servicing. Servicing should be referred to a qualified service technician.
7. Keep pets away from dryer, and keep the dryer door closed at all times except while loading or unloading. Pets may enter the dryer unnoticed when the door is open and become entrapped when the door is closed.
8. Lifetime lubrication is done at the factory, so the dryer never needs to be oiled or greased.
9. Do NOT use fabric softeners or products to eliminate static (unless recommended for use in clothes dryers by the manufacturer of the fabric softener or product).
10. Do NOT dry fiberglass articles unless recommended by the manufacturer.

**SAVE THESE INSTRUCTIONS**

## **WARNING! FIRE HAZARD**

Dry only articles which have been washed in water.

Articles which have been cleaned, washed, soaked, or spotted with gasoline, dry-cleaning solvents, oil, waxes, chemical solvents, alcohol, turpentine, or other flammable or explosive materials will retain these substances. Do not dry articles which still contain these flammable or explosive substances as they give off vapors that could ignite or explode.

Do not use heat to dry articles containing foam rubber, plastics, or similarly textured rubberlike materials.

Keep area around and underneath dryer free from the accumulation of combustible materials, such as lint, paper, rags, gasoline, and all other flammable vapors and liquids.

Do not allow the storage of any material to obstruct the ventilation air openings of the dryer.

To prevent extended drying time and risk of fire, clean the lint screen after each load.

The interior of the machine and exhaust duct should be cleaned periodically by a qualified service technician.

The exhaust system should be periodically examined for damage to the exhaust duct and for free operation of the exhaust deflector. Keep the area around the exhaust opening and surrounding areas free from the accumulation of lint, dust and dirt.

Recent studies have shown that if vegetable oil contaminated materials are incompletely washed, a carry-over and buildup of the oil may contribute to a chemical reaction (spontaneous combustion) that could cause a load to catch fire by itself. This would be more likely to happen if the load were left in the dryer after tumbling stopped or if items were folded and stacked while warm.

### **For Gas Dryers**

Gas dryers are equipped to operate on natural gas only. To convert a gas dryer for other gases, the services of a qualified service technician must be obtained.

## **Important Safety Notice & Warning**

The California Safe Drinking Water and Toxic Enforcement Act of 1986 (Proposition 65) requires the Governor of California to publish a list of substances known to the State of California to cause cancer or reproductive harm, and requires businesses to warn customers of potential exposures to such substances.

Users of this appliance are hereby warned that the burning of gas can result in low-level exposure to some of the listed substances, including benzene, formaldehyde, and soot, due primarily to the incomplete combustion of natural gas or liquid petroleum (LP) fuels. Exhaust ducts should be kept free of obstructions and properly exhausted dryers will minimize exposure.

**IMPORTANT:** *Because of continuing product improvements, Maytag reserves the right to change specifications without notice. For complete details, see the Installation Instructions packed with your product before selecting cabinetry, making cutouts or beginning installation.*

**SAVE THESE INSTRUCTIONS**

# Controls at a Glance

## Step 1

### Select Temperature

In order to select the correct temperature, turn the temperature control to one of three choices; Regular, Delicate or Fluff.

DRYER TEMPS	LOAD TYPE
Regular	Sturdy cottons or labels marked "Tumble Dry"
Delicate	Permanent press, synthetics and heat sensitive items.
Fluff	Items which need freshening. Load tumbles with room temperature air.

DRYER TEMPS	LOAD TYPE
Regular	Sturdy cottons or labels marked "Tumble Dry"
Delicate	Permanent press, synthetics and heat sensitive items.
Fluff	Items which need freshening. Load tumbles with room temperature air.

## Step 2

### Select Press Care

Press care is provided to minimize wrinkles and can only be used with the Permanent Press cycle. This wrinkle out feature provides 60 minutes of unheated tumble action at the end of the cycle. Clothes can be removed anytime during this portion of the cycle.

## Step 3

### Select Adjustable Signal Volume

This control allows for an adjustable signal volume ranging from off to loud. When the tumbling of laundry has stopped, this control will determine the end of cycle signal. This signal will inform you when the clothes are done and need to be removed from the dryer.

HEAVY DUTY / QUIET SERIES  
AUTO DRY CONTROL / 7 CYCLES

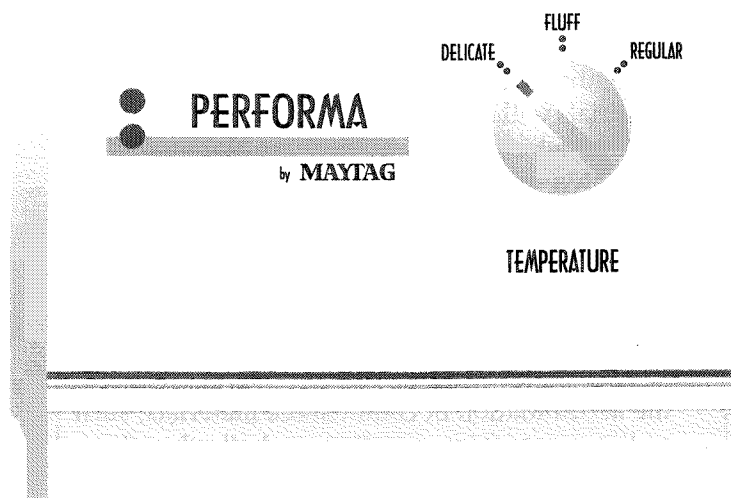

## Step 4

### Select Cycle

To select a cycle, rotate the control dial to the desired setting. When using an auto dry cycle, the control dial should point between "More Dry" and "Less Dry" for most loads.

Loads of larger or bulkier size may require the "More Dry" setting to completely dry the load. Drying clothes on the "Less Dry" setting are best suited for lightweight fabrics or for leaving some moisture in the clothing at the end of the cycle.

#### Auto Dry Permanent Press

The auto dry permanent press cycle is designed to dry all synthetic fabrics, double knits and permanent press fabrics automatically. At the end of the cycle, the clothes are cooled to reduce wrinkling for approximately 10 minutes. If additional care is needed for drying permanent press clothes, using the **PRESS CARE** option (see Step 2) will provide less chance for wrinkling.

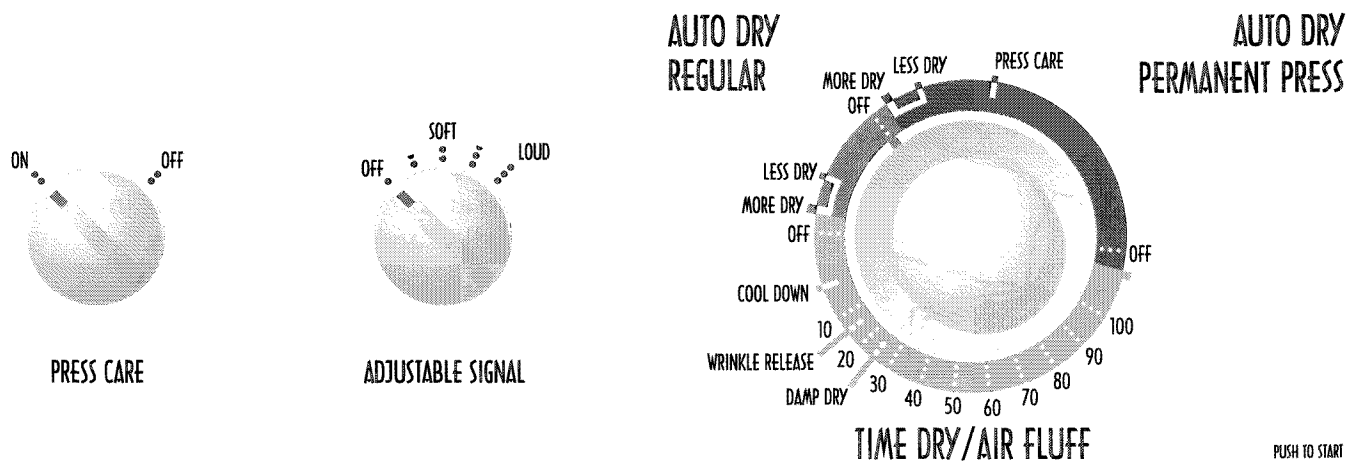

### Auto Dry Regular

The auto dry regular cycle is designed to dry most cottons and linens. At the end of the cycle, the clothes are cooled to reduce wrinkling for approximately 10 minutes.

### Time Dry/Air Fluff

This cycle can be used to regulate the drying time. This cycle uses either the Fluff, Delicate or Regular temperature control. For timed drying, turn the control dial clockwise until the pointer points to the proper time setting in the Time Dry/Air Fluff cycle. For heat sensitive items, use the Fluff temperature setting, but this will require a longer drying time.

### Special Options

**Damp Dry** is located on the Time Dry/Air Fluff section of the dial. It is designed to partially dry items. Depending on the temperature selected, it will provide 20 minutes of either heated or non-heated tumbling followed by 5 minutes of cool-down tumbling.

**Wrinkle Release** will release wrinkles from items that are clean and dry but only slightly wrinkled. These wrinkles may exist from a crowded closet or suitcase or from sitting in the dryer too long after the end of the cycle. It provides 10 minutes of heated or non-heated tumbling based upon the temperature selected and finishes with a 5 minute cool-down of no heat tumbling.

## Step 5

### Push the Control Dial in to Start

Push the control dial in to start the dryer. The dryer door must be closed for the dryer to start.

# Operating Tips

## Clean the Lint Filter

- After each load.
- To shorten drying time.
- To operate more energy efficient.

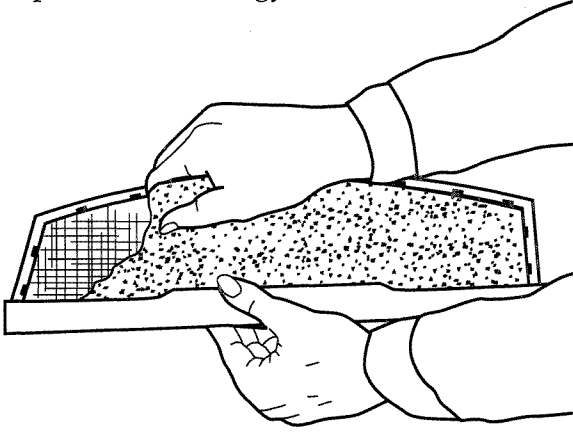

**Note:** Do not operate the dryer without the lint filter in place.

## Load the Dryer Properly

- Place only one washload in the dryer at a time.
- Mixed loads of heavy and lightweight clothes will dry differently. Lightweight clothes will dry, while heavy clothes may be damp.
- Add one or more similar items to the dryer when only one or two articles need drying. This improves the tumbling action and drying efficiency.
- Overloading restricts tumbling action, resulting in uneven drying as well as excessive wrinkling of some fabrics.

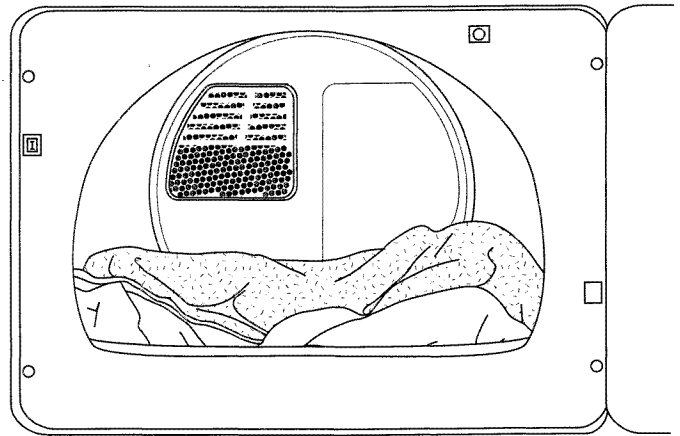

# Care & Cleaning

## Control Panel

Clean with a soft, damp cloth. Do not use abrasive substances.

## Tumbler

Remove any stains (such as crayon, ink pen or fabric dye) with soap and water. Then tumble clean old towels or rags to remove any excess stain.

## Cabinet

Wipe off any marks with soap and water. Use an appliance wax once a year if desired.

## Dryer Exhaust System

Inspect and clean once a year to maintain optimum performance. The outside exhaust hood should be cleaned more frequently to ensure proper operation. (Refer to the Installation Instructions for more information.)

## Replacing the Drum Light

- 1) Unplug or disconnect the dryer from the power supply.
- 2) Lift top of dryer by inserting a putty knife under top, 4" in from each side.
- 3) Rotate bulb holder to vertical position before removing bulb.
- 4) Push bulb down and rotate counterclockwise to remove.
- 5) Replace with a 25 watt, 115/125 volt twist lock utility light Part No. 53-0570 or equivalent. Place bulb in socket, push down and rotate clockwise.
- 6) Rotate bulb holder to horizontal position.
- 7) Place top of dryer back in original position. Make sure metal tabs hold top in place.
- 8) Reconnect dryer to power supply.

# Dryer Exhaust Tips

**⚠ WARNING** — Plastic or nonmetal flexible duct presents a potential fire hazard.

## Do

Read the installation instructions and the user's guide.

## Do

Let your dryer exhaust the air easily.

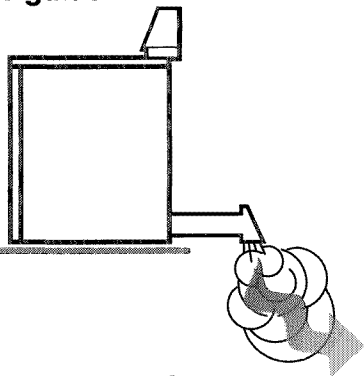

## Do

Use 4 inch diameter rigid metal duct. Tape all joints. Never use lint-trapping screws.

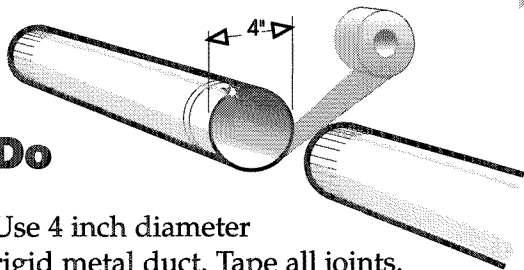

## Do

Keep duct runs as straight as possible.

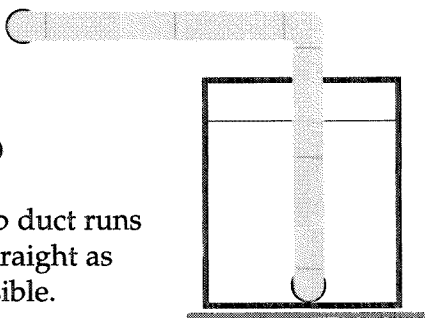

## Do

Clean all old ducts before installing your new dryer. Be sure vent flap opens and closes freely.

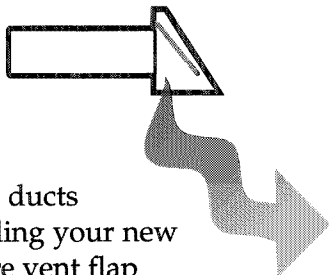

## Don't

Let a poor exhaust system cause slow drying.

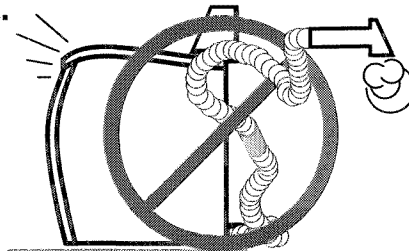

## Don't

Restrict your dryer with a poor exhaust system.

## Don't

Use plastic, thin foil, or non-metal flexible duct.

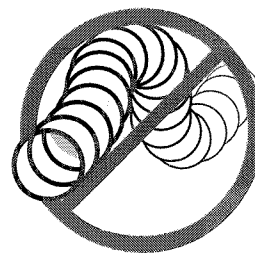

## Don't

Use longer than necessary duct runs with many elbows.

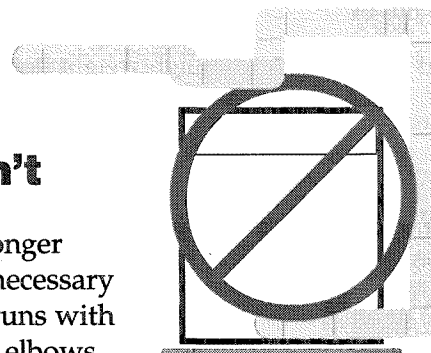

## Don't

Allow crushed or clogged ducts and vent.

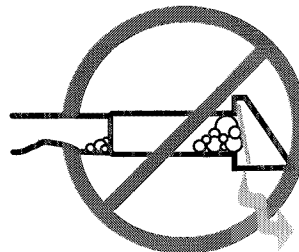

# Before You Call

## Check the following if your clothes dryer...

### Doesn't Run

- Be sure the door is shut.
- Is the electrical cord plugged in?
- Has a fuse blown or the circuit breaker tripped?
- Push the Control dial in again if the door was opened during the cycle.

### Doesn't Heat

- Has a fuse blown or the circuit breaker tripped?
- Select a heat setting, not fluff.
- Check that the gas supply is on for gas dryers.

### Doesn't Dry Properly

- Check all of the above, plus ...
- Check the exhaust hood outside the house, does it open and close freely?
- Clean the lint filter and exhaust duct.
- Use rigid 4" metal exhaust duct.
- Do not overload. 1 wash load = 1 dryer load.
- Sort heavy items from lightweight items.
- Check the washer to be sure it is draining properly to extract water from the load.

### Is Noisy

- Check the load for objects such as coins, nails, etc. Remove promptly from dryer.
- The dryer should be level and installed on a solid floor.

*For further help, call Maytag Customer Assistance: U.S. 1-800-688-9900 or Canada 1-800-688-2002*

MAYTAG • 403 W. 4<sup>th</sup> Street N. • Newton, Iowa 50208