

MAKERA | CARVERA AIR

INSTRUCTION MANUAL

MAKERA
BE A MAKER, SHAPE AN ERA!



www.makera.com

v1.4



02

Welcome

14

Preparation

Phone/Tablet Stand	
Installation	16
Control Software	
Installation	16
WiFi Configuration	17

34

Tool Kit

Wired Probe	36
Manual Probe	38
Emergency Stop Button	39
Workholding Tools	41
Bit Collar Installer	42
Dust Collection Module	43
Spindle Collet Installer	44
Air Assist Module	45
Rotary Module	46
Laser Module	48

04

Safety

18

Software

Overview	20
Status Toolbar	21
Task Toolbar	26
G-Code/MDI	29
G-Code Preview	30
Manual Operation	31
Errors	32
General Workflow	32

50

Feed & Speed

08

Unpack

51

CAM

Welcome

Welcome to the world of CNC! Whether you're new to CNC or an experienced user, Carvera Air provides a seamless experience with its advanced features. Enjoy the ease of a quick tool changer, automatic probing, and auto-leveling, all designed to simplify learning and operation, so you can fully harness Carvera Air's outstanding machining capabilities.

This manual focuses on operating the machine and its control software, rather than CAD and CAM tutorials. Carvera Air supports standard G-Code and is compatible with most CAD/CAM software.

For specifications and more information, please visit our official website:
www.makera.com

If you have any problems with Carvera Air, please contact us directly:
support@makera.com

Also, join in the Facebook group to discuss and share your experience with other Carvera Air users:
www.facebook.com/groups/carveraair

We will keep updating video tutorials and sample making cases on the YouTube channel, do not forget to subscribe!
www.youtube.com/c/Makera

In this manual, you will have a quick walkthrough of how to use your Carvera Air and know its powerful abilities.

But for more information, please see additional guides and tutorials on our wiki:
makera.com/wiki



Safety

Disclaimer

Please read this manual carefully before using the Carvera Air. Failure to read the manual may lead to personal injury, inferior results, or damage to the Carvera Air machine.

This manual is provided for reference purposes only. We reserve the right to modify or revise this manual, users can download the most up-to-date version of this manual on our website.

You should always monitor machines when in use. Milling cutters revolving in high-speed, unstable components or laser module in operation are dangerous to people without protection. Please carefully read the safety instructions below to avoid unnecessary harm.

Safety Instructions

1. Always wear safety goggles when operating the machine, especially when the protective cover is open.
2. Always wear laser protection goggles when using the laser module.
3. Please wear hearing protection when Carvera Air is machining on the hard materials.
4. Do not leave your machine unattended while it is machining.
5. Please be aware of the sharpness of the milling bits during installation, dust collection, and other operations.
6. Milling will generate heat. Inappropriate parameters will cause fire hazards. Make sure an extinguisher is in your vicinity.
7. Some materials are harmful to people when machining, such as carbon fiber. Please wear a face mask and connect a vacuum for dust collection.
8. Do not expose this machine to rain or wet conditions.
9. Keep children and bystanders away while operating this machine. It requires supervision and the assistance of an adult when children use this machine.

If an emergency occurred in machining, such as the workpiece being loose from holding, components damaging, unusual light or sound coming from the machine, etc. Press the main button or E-Stop button, all ongoing procedures will stop immediately, or cut off the power to shut it down.

Carvera Air has a safety option that allows the machine to automatically stop working when opening the cover, which is useful for schools or work environments where children may reach.

FCC Compliance

This equipment has been tested and found to comply with the limits for a Class B digital device, pursuant to part 15 of the FCC Rules. These limits are designed to provide reasonable protection against harmful interference in a residential installation. This equipment generates, uses and can radiate radio frequency energy and, if not installed and used in accordance with the instructions, may cause harmful interference to radio communications. However, there is no guarantee that interference will not occur in a particular installation. If this equipment does cause harmful interference to radio or television reception, which can be determined by turning the equipment off and on, the user is encouraged to try to correct the interference by one or more of the following measures:

- Reorient or relocate the receiving antenna.
- Increase the separation between the equipment and receiver.
- Connect the equipment into an outlet on a circuit different from that to which the receiver is connected.
- Consult the dealer or an experienced radio / TV technician for help.

Caution: Any changes or modifications to this device not explicitly approved by manufacturer could void your authority to operate this equipment.

This device complies with part 15 of the FCC Rules. Operation is subject to the following two conditions:

(1) This device may not cause harmful interference, and (2) this device must accept any interference received, including interference that may cause undesired operation.

This equipment complies with FCC radiation exposure limits set forth for an uncontrolled environment. This equipment should be installed and operated with minimum distance 20cm between the radiator & your body.

ISED Compliance

This device complies with Innovation, Science and Economic Development Canada License exempt RSS standard(s). Operation is subject to the following two conditions:





(1) this device may not cause harmful interference, and (2) this device must accept any interference received, including interference that may cause undesired operation of the device.

Le présent appareil est conforme aux CNR d'Innovation, Sciences et Développement économique Canada applicables aux appareils radio exempts de licence. L'exploitation est autorisée aux deux conditions suivantes : (1) l'appareil ne doit pas produire de brouillage, et (2) l'utilisateur de l'appareil doit accepter tout brouillage radioélectrique subi, même si le brouillage est susceptible d'en compromettre le fonctionnement.

The device is compliance with RF exposure guidelines, users can obtain Canadian information on RF exposure and compliance. The minimum distance from body to use the device is 20cm.

Le présent appareil est conforme Après examen de ce matériel aux conformité ou aux limites d'intensité de champ RF, les utilisateurs peuvent sur l'exposition aux radiofréquences et compliance d'acquérir les informations correspondantes. La distance minimale du corps à utiliser le dispositif est de 20cm.

Safety Labels

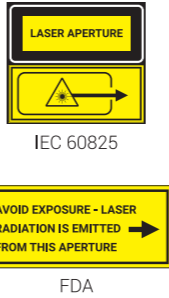
Safety Labels	Meaning	Location
	Keep hands clear of moving parts: machine axis, spindle, etc.	On the machining cover
	Wear safety goggles when operating the CNC function or laser goggles when operating the laser.	On the machining cover
	Caution sharp cutters when installing milling bits and doing dust collection.	On the machining cover
	Laser radiation - Class 4 laser product, avoid eyes or skin exposure to direct or scattered radiation.	On the Laser module cover
	Laser aperture - Laser radiation is emitted from this aperture.	On the Laser module

Model: CA1

The mass of the box weighs more than 50Kg/ 110lb. The net weight of the Carvera Air desktop milling machine is around 35Kg/77lb. We suggest moving this machine by at least two people (with gloves) to ensure both personal and machine's safety. Please make sure your desk is sturdy enough and has no less than 60 x 60 cm space to place this machine.

Unpack

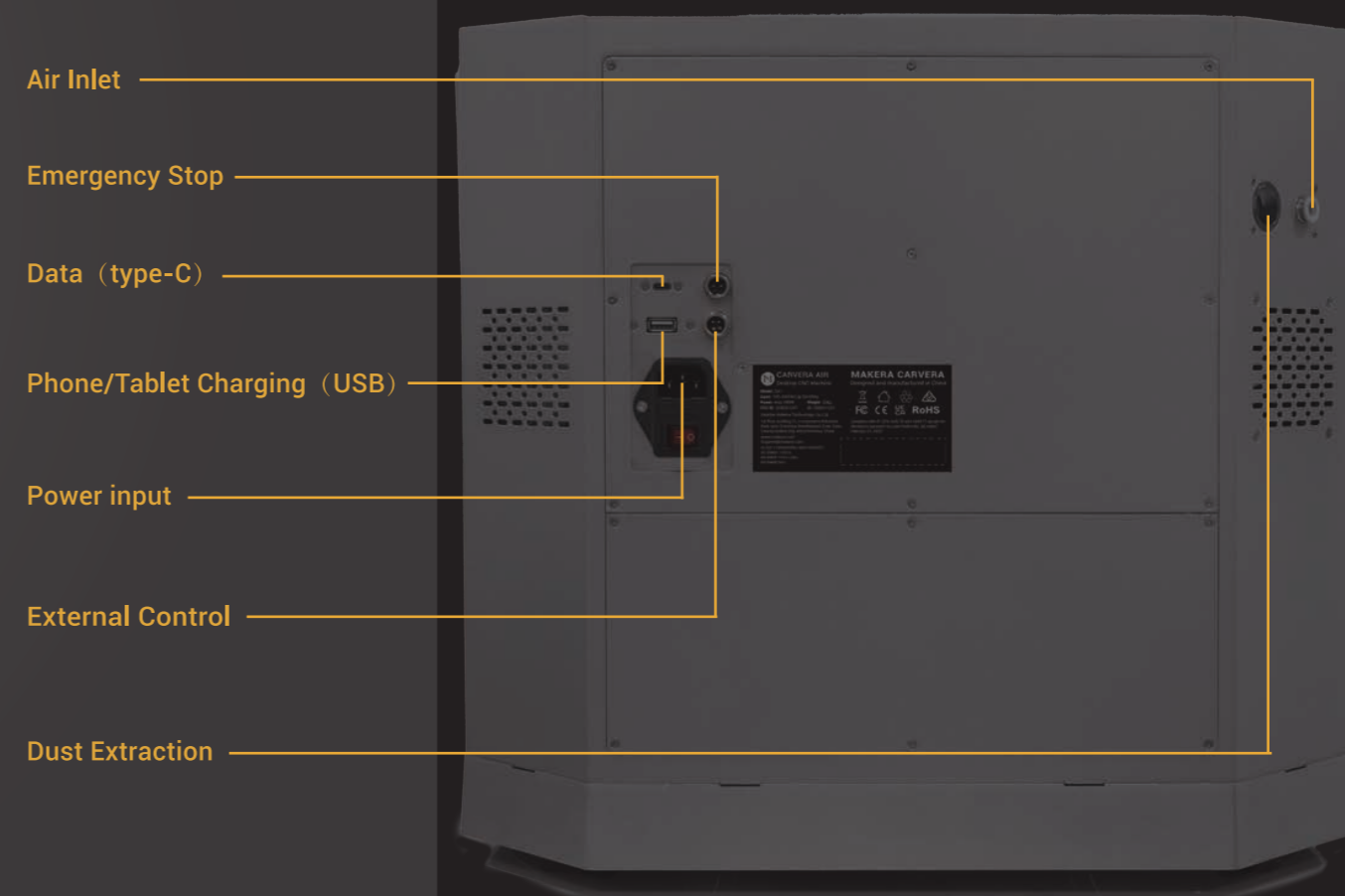
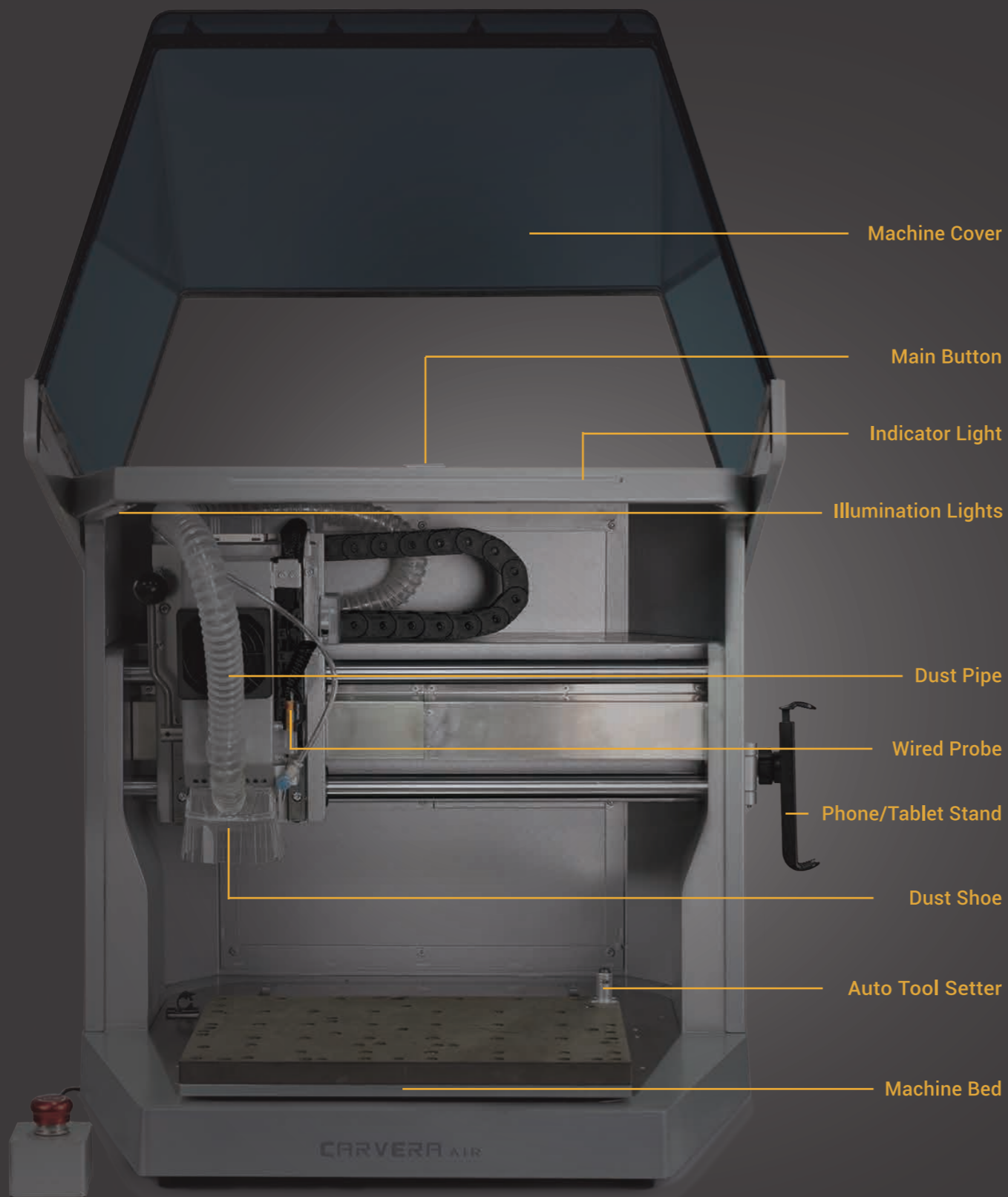

Unpack

1. Remove the protective foam from the top and sides inside the box.



2. With the help of another person, carefully lift the machine out of the box from the positions shown in the illustration.



3. Place the machine on a stable, flat surface.

4. Remove the plastic packaging bag.

5. Carefully open the machine's top cover by following the operational steps shown in the illustration below.

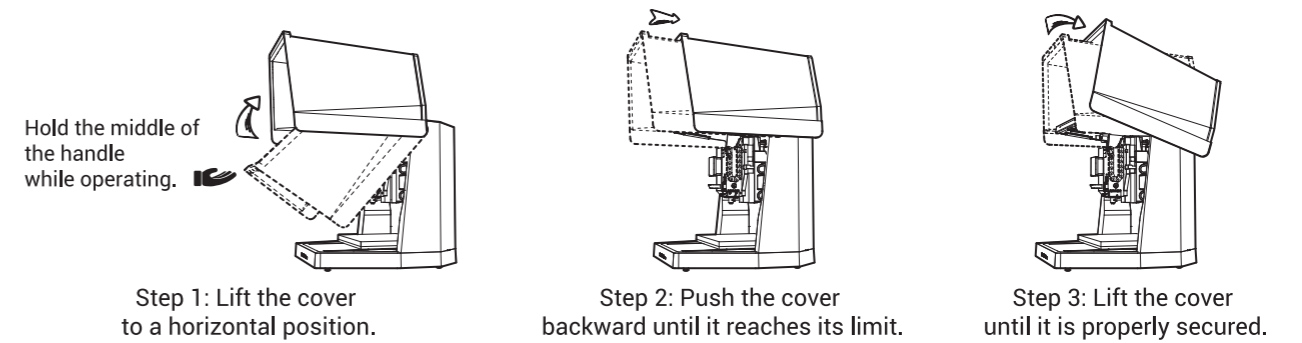

Note: When opening the top cover, follow the illustrated steps to avoid damage.

6. Gently remove the inner foam and accessories from inside the machine.



Note: Please keep the carton, foam, and plastic packaging bag for future use.

Parts list

- Spare 1/8" bit collar x 30
- Spare tool bit x 10
- Safety goggles x 1
- Emergency stop button x 1
- Manual tool setter x 1
- USB cable x 1
- Power cable x 1
- Phone/Tablet Stand x 1



- 4th Axis x 1
- Epoxy tooling board x 2 for 4th Axis
- 4th Axis chuck wrench x 2

- L bracket x 1
- 4mm Dowel pin x 10
- M5 Screws x 20
- Screw driver x 1
- Top clamp x 4
- Spare tool bit x 10
- Bit collar installer x 1
- Spindle collet (optional)
- Spindle collet installer x 1

- Sand block x 2
- Epoxy tooling board x 2
- LED light assembly kit x 1
- Mini hand saw x 1
- Single side PCB x 2
- Double side PCB x 2
- Acrylic plate x 2
- MDF Waste board x 2
- ABS Plastic board x 1
- Aluminum plate x 1

- Connection cable x 1
- Laser goggles x 1
- Laser Module x 1



Preparation



Power On

1. Plug the power cable and turn on the power switch.
2. Carvera Air homes all axes automatically and turn on the Illumination lights.

Phone/Tablet Stand Installation

To facilitate transportation, the phone/tablet stand is not pre-installed. To install it, remove the screws from the stand base, position the stand, and secure it by reattaching the screws.

For your convenience, the stand can be installed on either the right or left side of the machine; the default position is the right side.



Control Software Installation

1. Go to www.makera.com to download and install the Carvera Controller. It currently supports computers, tablets, and phones. We recommend using the computer version of the control software for your first use. Please refer to the next chapter for software instructions.

Download link: <https://www.makera.com/pages/software#MakeraController>

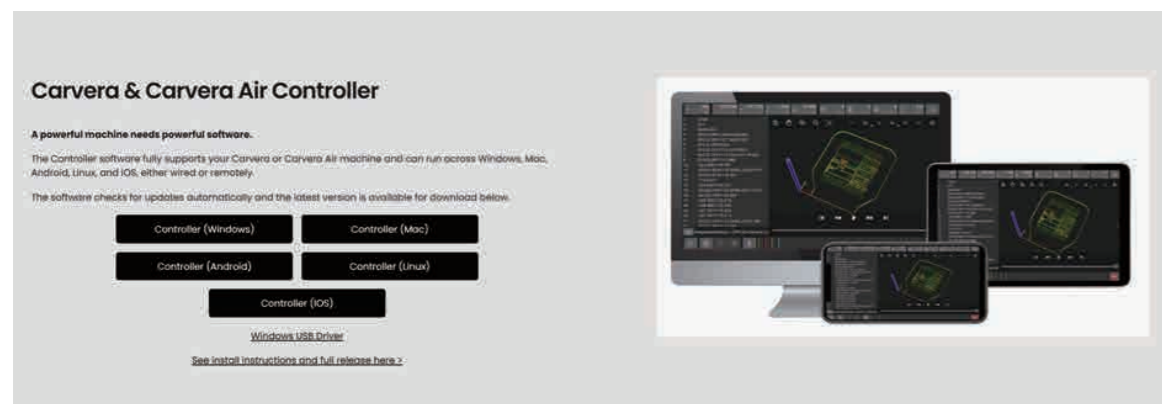

2. If you plan to connect via USB, download and install the Carvera Air USB driver.

WiFi Configuration

Recommended

The purpose of configuring WIFI is to allow Carvera Air to join the network at your workplace so that your computer can control the machine without being restricted.

1. The network can be configured via a USB cable or the machine's built-in WiFi accessing point.

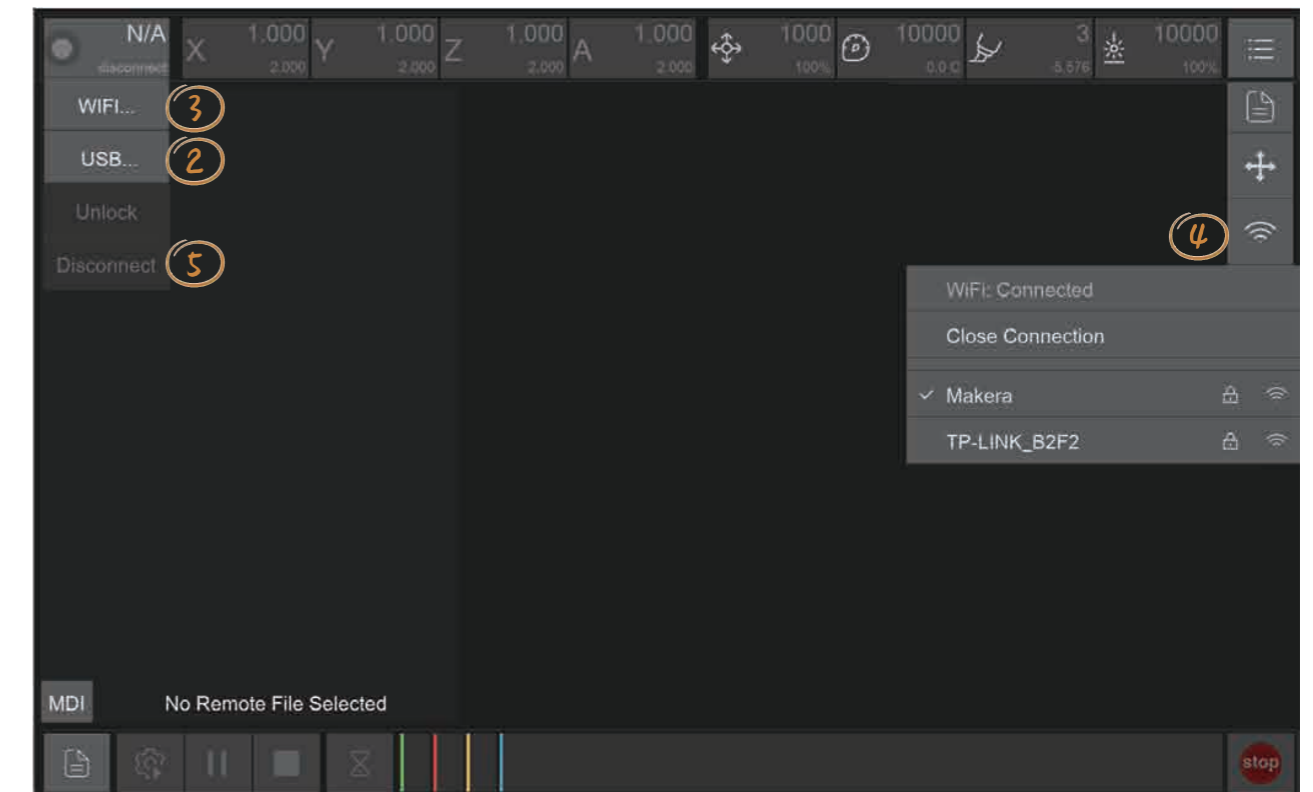

2. Connect via USB: Connect the USB cable and open the Carvera Air control software. Click the status button in the status bar, click "USB...", you will see your USB device and choose one to connect. Then the status button will be updated, displaying machine is connected in USB mode.

3. Connect via accessing point: Open the WiFi setting on your computer, find the accessing point named CARVERA_AIR_XXXXX and connect (No password). After successfully connected, open the Carvera Air control software; click the status button in the status bar; click "WIFI..."; Carvera Air will automatically search connectable devices. Please refresh it if Carvera Air cannot find any devices. After connecting to the device, the status button will be updated; displaying machine is connected in WiFi mode.

4. WiFi configuration: Click the "more" button (end of the status bar) in the status bar; click the WIFI icon, the system will start searching WIFI in the workplace. Select a WIFI, enter the password and connect. Please retry if the connection failed.

5. Disconnect: Click the status button; click "Disconnect"; Switch back to your WiFi.

6. Redo step 3 from Click "WIFI" to connect Carvera Air through WIFI.



CARVERA AIR

Software Introduction

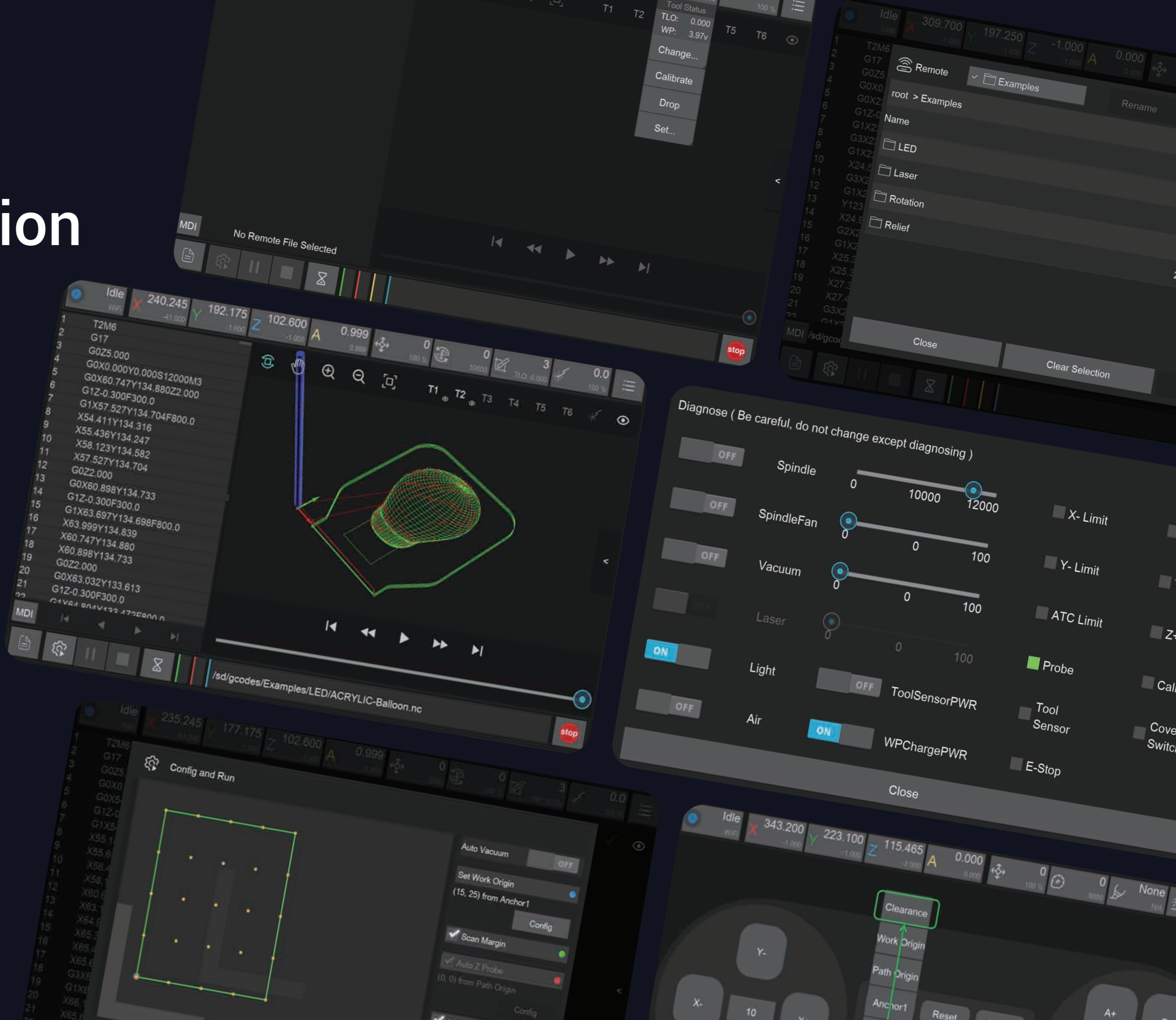

Overview

1. Status Toolbar

The status toolbar is on top of the interface. It shows the real-time data of key indicators and can be used to control these indicators.

2. Task Toolbar

Task toolbar is at the bottom of the interface. In the task toolbar, you can manage G-Code files, configure, track and control machining process.

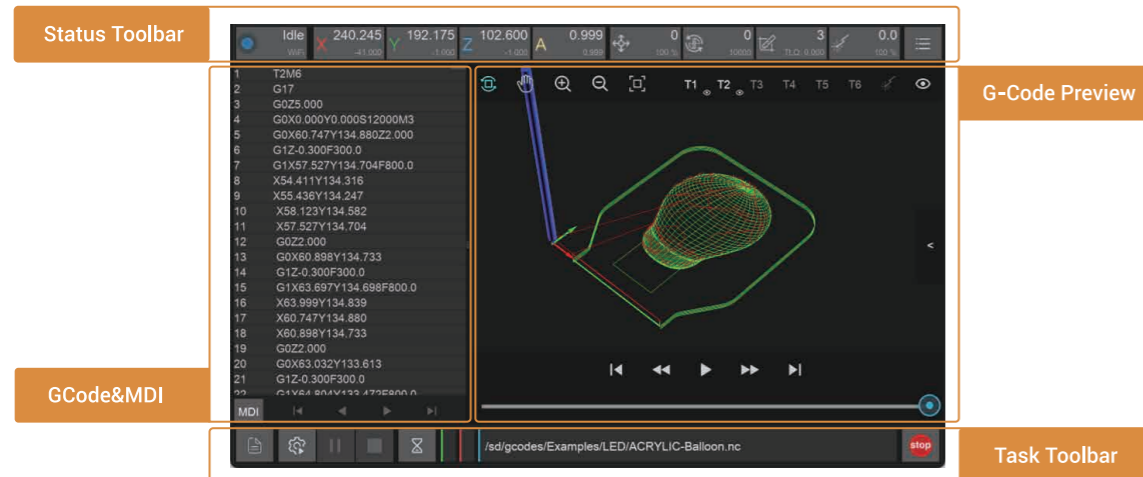

3. G-Code & MDI

By default, this interface displays the G-Code of the currently opened file. It can be switched to the command information sent/received by the machine.

4. G-Code Preview

The G-Code preview graphically displays the currently opened file G-Code..



5. Manual Operation

Manually control Carvera Air's movement and execute other commands. Because Carvera Air does most of the jobs automatically, the manual control interface is hidden by default. Click the arrow on the right side of the interface to switch whether to display it.

Status Toolbar

All indicators include 3 items: a symbol, main data and sub-data. Click the button can open the corresponding drop-down list.

1. Machine status and control

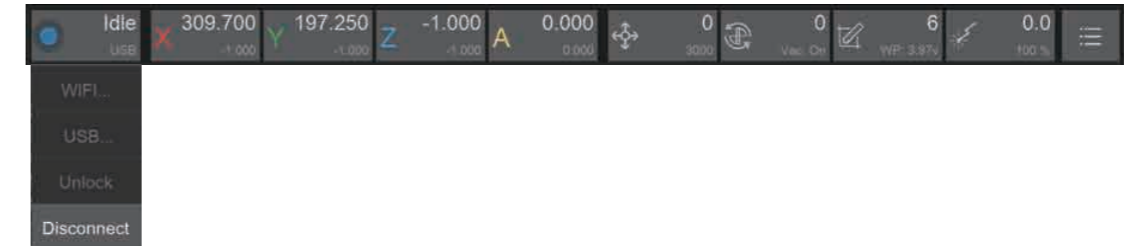

1.1. Symbol: A unique colour to distinguish the status.

1.2. Main data: Explanation of device status.

1.3. Sub-data: Current connection mode.(No connection, WiFi or USB)

1.4. Drop-down list:

1.4.1. **WIFI**: Connecting Carvera Air via WiFi.

1.4.2. **USB**: Connecting Carvera Air via USB.

1.4.3 **Unlock/Reset**: Unlock or reset Carvera Air.

1.4.4. **Disconnect**: Disconnect Carvera Air from your device.

Explanation of different Carvera Air statuses :

Colour	Status	How It Is Triggerer/How To Quit
	Idle	Carvera is idle
	Run	Carvera is working
	Alarm	Carvera has an alarm/Unlock it to restore
	Home	Carvera is resetting the coordinate
	Hold	Click the hold button/Click again to resume
	Wait	Carvera is emptying the buffer
	Disable	No device has been connected
	Sleep	Timeout/Reboot Carvera to restore
	Pause	Click the pause button/Click again to resume
	Tool Wait	Wait for tool changing

2- Coordination status and control



2.1. Symbols: X/Y/Z/A

2.2. Main data: Work Coordinates (The position of the tool relative to the work origin). This position depends on where you place your workpiece and where you want to start machining on it.

2.3. Sub-data: Machine coordinates (The position of the tool relative to the machine origin). The machine origin is fixed and located at the upper-right corner of the machine, so these coordinates are generally negative.

2.4. Drop-down list:

2.4.1 Set Origin: Use this option to set the work coordinates for the X, Y, Z, and A axes; You can either set them to zero or specify a specific value based on the current position; Typically, Carvera Air uses two fixed anchor points to automatically set the starting point, so you usually don't need to set the origin manually.

2.4.2 Rotary axis (A axis):

Shrink Function: Use this to calculate the remainder of the rotation angle modulo 360 degrees when dealing with large rotation angles.

Fast Move Function: This function first executes the "Shrink" function and then rotates directly to the specified position.

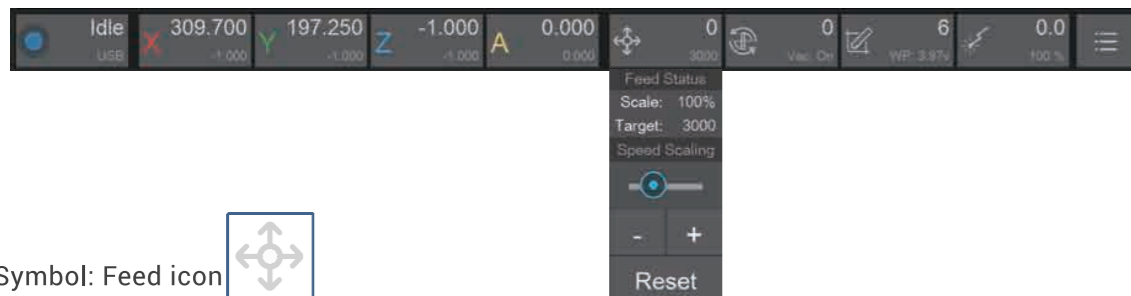

3.1. Symbol: Feed icon

3.2. Main data: Real-time feeding speed

3.3. Sub-data: Target feeding speed/Feeding speed scale(moving message)

3.4. Drop-down list:

3.4.1. Feed Status: Target feeding speed /Feeding speed scale

3.4.2. Speed Scaling: Set the feed rate by percentage. For safety reasons, the adjustment range is limited to 50% to 200%

Note: Adjusting the feed rate will not take effect immediately. Generally, it will take a few seconds to wait for the current command to finish.

4. Spindle status and control

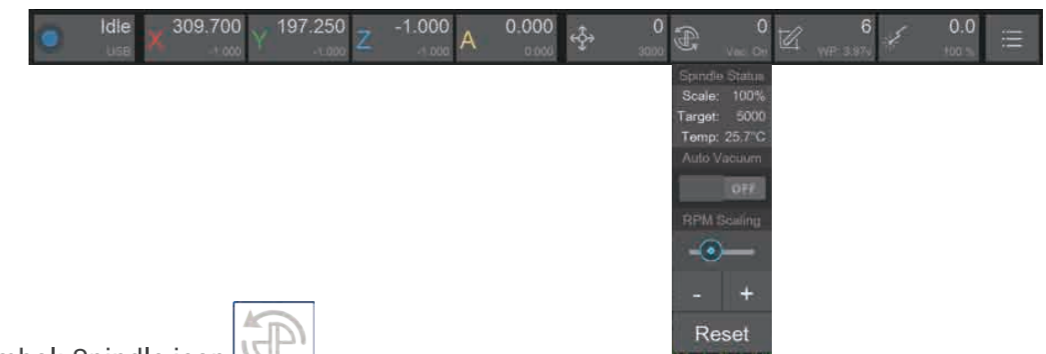

4.1. Symbol: Spindle icon

4.2. Main data: Real-time spindle rotary speed (RPM)

4.3. Sub-data: Target spindle rotary speed/ Spindle speed scale/Real-time spindle temperature (moving message)

4.4. Drop-down list:

4.4.1. Spindle Status: Target spindle rotary speed/ Spindle speed range /Real-time spindle temperature summary display

4.4.2. Auto Vacuum: Choose to turn on/off auto vacuum while the spindle is rotating. Default - on.

4.4.3. RPM Scaling: Set the spindle speed range by percentage. For safety reasons, the adjustment amount range is limited from 50% to 200%.

Note: Turn on the Vacuum or adjust the spindle rotary speed will not take effect immediately. Generally, it will take a few seconds to wait for the current command to finish.

5. Tool status and control



5.1. Symbol: Tool icon

5.2. Main data: Display the number 1 to 6 of the current tool on the spindle, no tool - "None", wireless probe - "Probe"

5.3. Sub-data: Current Tool Length Offset (TLO) /Wireless Probe Power(moving message)

5.4. Drop-down list:

5.4.1 Tool Status: TLO/Wireless Probe Power summary display

5.4.2. Change tool: Change to the selected tool or wireless probe, and perform automatic calibration.

5.4.3. Calibrate tool: Automatically calibrate the current tool and set TLO.

5.4.4. Drop tool: Drop the current tool.

5.4.5. Set tool: Manually set the current tool number. Only use when the tool number is wrong.

6、Laser status and control

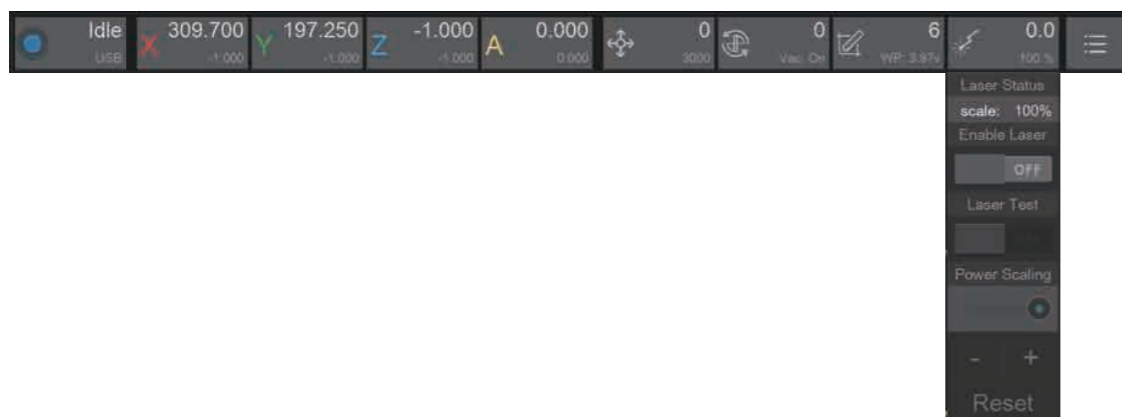

6.1. Symbol: Laser icon



6.2. Main data: Current laser rate

6.3. Sub-data: Laser power scale

6.4. Drop-down list:

6.4.1. Laser Status: Laser power scale

6.4.2. Enable Laser: Switch to laser mode. The working coordinates will be automatically updated according to the preset offset. If there is a tool on the current spindle, Carvera will drop it first and calibrate again to check the laser head's height.

6.4.3. Laser Test: Performing a laser test after turn on the laser mode will trigger a low-power laser beam for focus calibration.

6.4.4. Power Scaling: Set the laser power range by percentage. For safety reasons, the adjustment amount range is limited from 50% to 200%.

Note: Carvera has already set the coordinate offset of the laser before delivery, only reset it when the coordinates deviate. We will add relevant tutorials in the online instructions.

7、Other functions

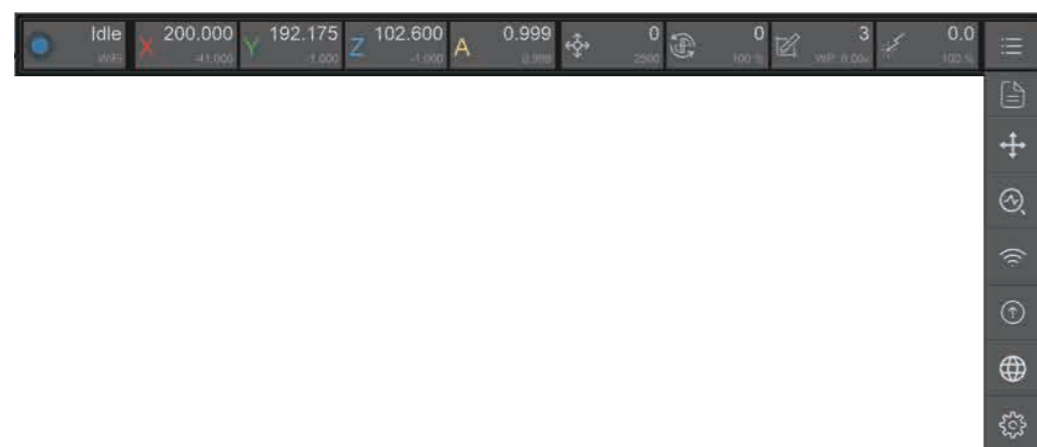

7.1. Manual control: Same function as the arrow button on the right side of the interface. Switch to display manual control interface and file preview interface.

7.2. Device status diagnose: Check and your Carvera Air in detail and debug. No need to use it when Carvera Air runs in good condition. We will add a tutorial in the formal version of the instruction manual.

7.3. WiFi configuration: Refer to the previous WiFi setting instruction in chapter 4.

7.4. Software Upgrade:

7.4.1. Controller: Control software upgrade

7.4.2. Firmware: Firmware upgrade

7.4.3. Download: Link to the download page

7.4.4. Upgrade: For control software, just install the new version and you are ready to use. For firmware, you need to upload it to the machine using the control software

7.4.5. Check at Startup: Check software updates and notice at the startup

7.5. Language selection.

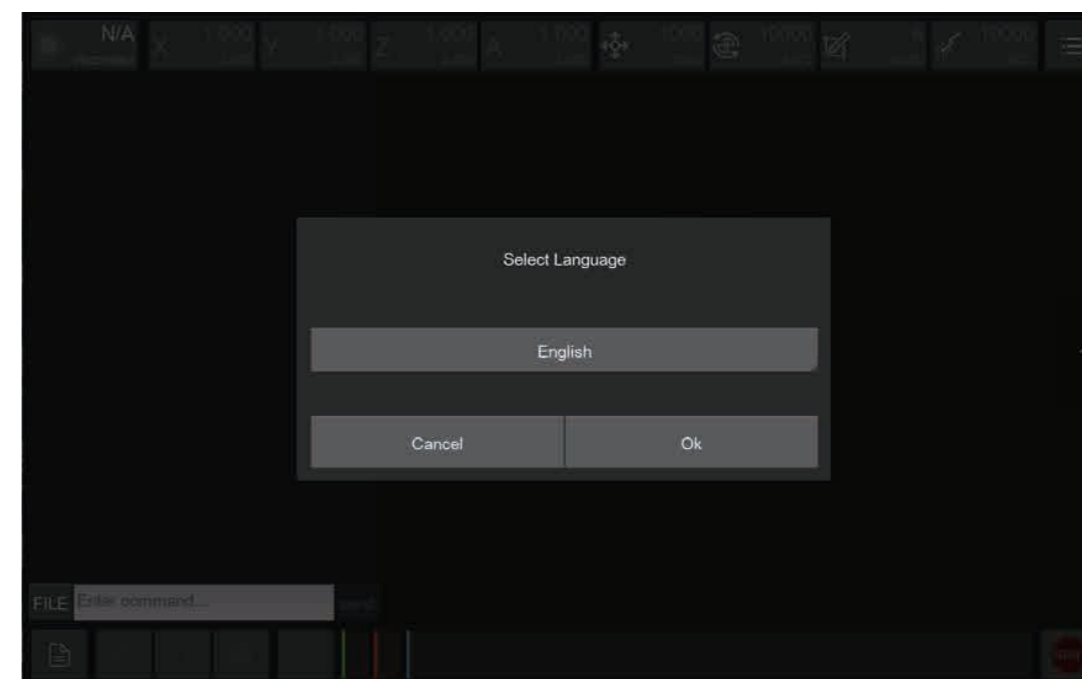

7.6. Parameters settings:

7.6.1. Basic parameters: Adjust functional parameters by requirements.

7.6.2. Advanced parameters: System-level of the machine. All set in the factory generally does not need to be changed. Do not change it unless it has to.

7.6.3. Restore setting: Restore factory setting, or save current setting as factory setting.

Note: You need to click the Apply button to save all parameters after changing them and rebooting the machine to apply changes. Parameter introduction and recommended settings are provided in the parameter list. We will add more detailed parameter introductions and setting suggestions in the online instruction manual.

Task Toolbar

1. File management and selection

Carvera Air's G-Code is executed in the controller to ensure the task's efficiency and stability and avoid task failures caused by WiFi or USB connection instability. Therefore, the G-Code file needs to be uploaded to the machine before running the program. We have created examples folder on the machine and have already uploaded sample G-Code files.

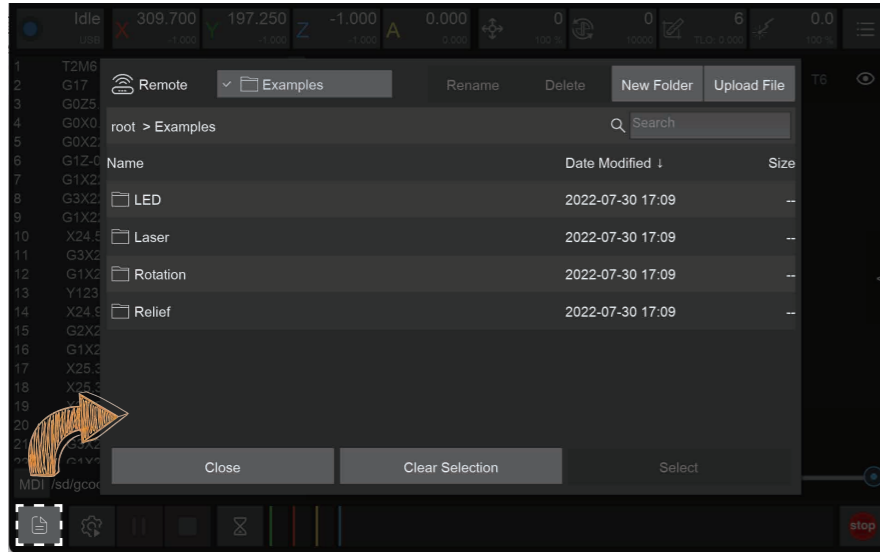

1.1. Remote file management:

- 1.1.1. Rename: Rename files or folders in the machine.
- 1.1.2. Delete: Delete files or folders in the machine.
- 1.1.3. New Folder: Create a new folder under the current file path.
- 1.1.4. Upload File: Switch to local file interface for uploading.
- 1.1.5. Close: Close the file management interface.
- 1.1.6. Clear Selection: Clear the currently selected G code file.
- 1.1.7. Select files: Select the G-Code file to run.
- 1.1.8. Recent Places: Short cut for recently used directories.

1.2. Local file browsing:

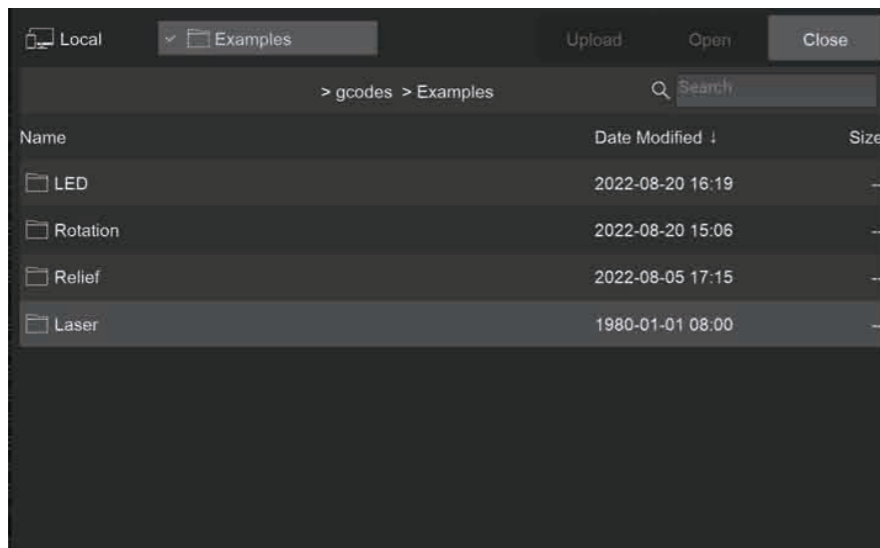

It opens the gcodes subdirectory under the local program installation directory by default. Therefore, we recommend putting your G-Code files here for easy management.

Upload: Select and upload local files.

Open: Open the file and preview it without uploading it (you can also do this without connecting the Carvera).

Close: Back to the remote file management interface.

Recent Places: Short cut for recently used directories.

2. Task configuration and execution

If you have used CNC before, you definitely know that a CNC machining task requires a lot of preparation work, including setting the work coordinates (XY axis tool setting), Z-axis tool setting, workpiece levelling (PCB processing) and so on.

Because Carvera Air has automatic detection and leveling functions, we have integrated these settings and task execution into one interface.

We provide an innovative method that using "anchor points" for work coordinate setting, allowing you to locate XY-axis positions accurately through easy configuration.

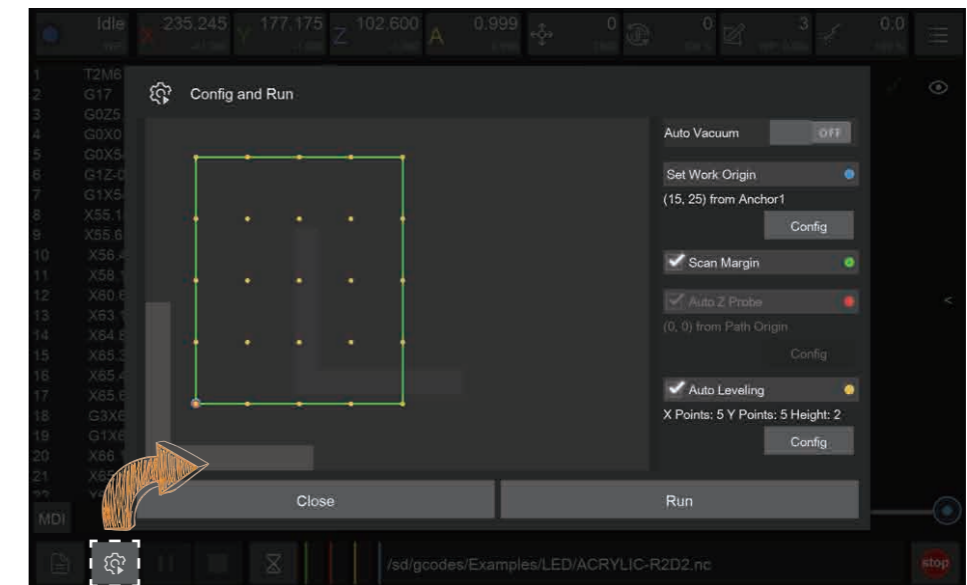

2.1. Auto Vacuum: Allows the machine to automatically toggle the dust collection signal during task execution enabling automatic control of external dust collection equipment. We will provide detailed instructions in the 'Tool Kit' chapter.

2.2. Machining area preview: Display the preview of the machining area according to the current work coordinates and G-Code file.

L-shaped gray symbol: Anchor point position. You can choose to install the L-shaped bracket to be located either to point 1 or point 2.

Blue Circle: Zero position of work coordinate.

Green line area: G-Code file machining range.

Green Bold line area: Indicates that Scan Margin is activated to automatically scan the area before machining.

Red Circle: Z probe position when Auto Z Probe is selected.

Yellow Circle matrix: Levelling matrix when Auto Levelling is selected.

2.3. Set Work Origin: Set the work coordinates zero point relative to anchor points - the X/Y axis distance relative to anchor point 1 or 2. (Only X distance is needed when performing 4-Axis machining). Please note that the work coordinate settings will take effect immediately.

2.4. Scan Margin: Scan the rectangle path area before machining. When scanning, machine will switch to the wireless probe and turn on the red laser for observation. We recommend new users turn on this while running job.

2.5. Auto Z Probe: Z-axis tool setting is required after changing the workpiece or the zero points of the work coordinate. When doing Z probe, machine will automatically switch to the wireless probe and do probe at the set position.

Work Origin: Perform Z axis probe at a certain distance related to the X/Y axis of the working coordinate zero point.

Path Origin: Perform Z axis probe at a certain distance related to the actual X/Y machining starting point (lower left corner). This method is selected by default.

2.6. Auto Leveling: If requiring uniform machining depth, please select the automatic leveling option such as PCB engraving. You can set the leveling matrix size and the lifting height when moving horizontally during the leveling process. The less the flatness, the higher the lifting height needs to be. The higher the requirement for machining consistency, the denser the matrix. For PCB engraving, it is better to have matrix dots spaced about 1 cm apart.

2.7. Run: Click to start machining process. If you set the scanning area, Z-axis tool setting or automatic leveling, the G-Code file will be executed after the automatic detection is completed.

Note: The wireless probe is a precise device that integrates mechanics and electronics, which is easy to damage. Please be careful when using it. Make sure no obstacles can block its way. We suggest new users turn on the scan margin function to preview the route. It is recommended to leave sufficient margin between L bracket position and path start point, greater or equal to 10/10mm.

3. Task control



3.1. Task pause: Pause the running G-Code task and you can manually control the machine afterwards. But if you want to resume the task, please remember to turn on the spindle, or it may damage the tool if it resumes without rotating the spindle. 

3.2. Task stop: Terminate the current G-Code task. 

3.3. Task hold: Similar to task pause, but the pause speed is faster and cannot control the machine manually during holding. 

3.4. Task track: Display the current G-Code task name, running time, percentage and other information. 

3.5. Emergency stop: Immediately stops the current task, turn off the spindle, the same function as the physical button in front the machine. 

Note: The current task cannot be stopped immediately when the task is paused or held. It has to wait for the buffer zone finish. If emergency occurs that needs to stop the machine immediately, please click the emergency stop button in the software or press the physical emergency stop button on the front panel of the machine. Carvera is built by closed-loop servo motors, and it saves the coordinate and status at each step. Therefore, no needs to reset the tool after reboot/unlock.

G-Code/MDI

1. G-Code interface: Display the currently opened remote or local G-Code file. When the task is running, it will track and highlight the running line in real-time.

2. MDI: Display detailed send/receive commands, similar to the log information. In specific cases, you can manually enter the g-code for operation and diagnosis. Enter "clear" to clear the current command area.

```

1 T2M6
2 G17
3 G0Z5.000
4 G0X0.000Y0.000S12000M3
5 G0X51.828Y132.431Z2.000
6 G1Z-0.300F300.0
7 G1X51.870Y132.569F800.0
8 X52.089Y132.951
9 X52.628Y133.057
10 X53.378Y133.114
11 X55.105Y133.076
12 X57.634Y132.831
13 X60.124Y132.406
14 X61.760Y132.036
15 X62.297Y131.884
16 X62.369Y131.666
17 X62.634Y130.101
18 G3X63.140Y126.325I80.982J8.918
19 G1X63.142Y124.814
20 X63.079Y124.490
21 X62.573Y124.558
22 Y57.298V125.197
  
```

MDI /sd/gcodes/Exempl...ACRYLIC-R2D2.nc



```

GCode: G91!
GCode: G0X-10!
ok
G91G0X-10
GCode: G91!
GCode: G0X-10!
ok
G91G0X10
GCode: G91!
GCode: G0X10!
ok
G10L20P0X0
GCode: G10L20P0X0!
ok
G10L20P0Y0
GCode: G10L20P0Y0!
ok
G10L20P0X-359.2Y-234.1
GCode: G10L20P0X-359.2Y-234.1!
ok
Is
sd/
  
```

FILE Enter command... send



G-Code Preview

1. Graphical preview: Open the G code file to preview the G code graphics in the tool path preview area. Green lines are G1/G2/G3 code, and red lines are fast moving G0 code.

2. Display control toolbar: You can pan (right mouse button), rotate (left mouse button), zoom in (scroll wheel up), zoom out (scroll wheel down), and restore the preview (double-click) . You can also select to show/hide the G-Codes for for different tools.

3. Playback toolbar: When the task is not running, you can play, fast forward, or backward the preview. When the task is running, the preview graph shows the real-time machining trace.

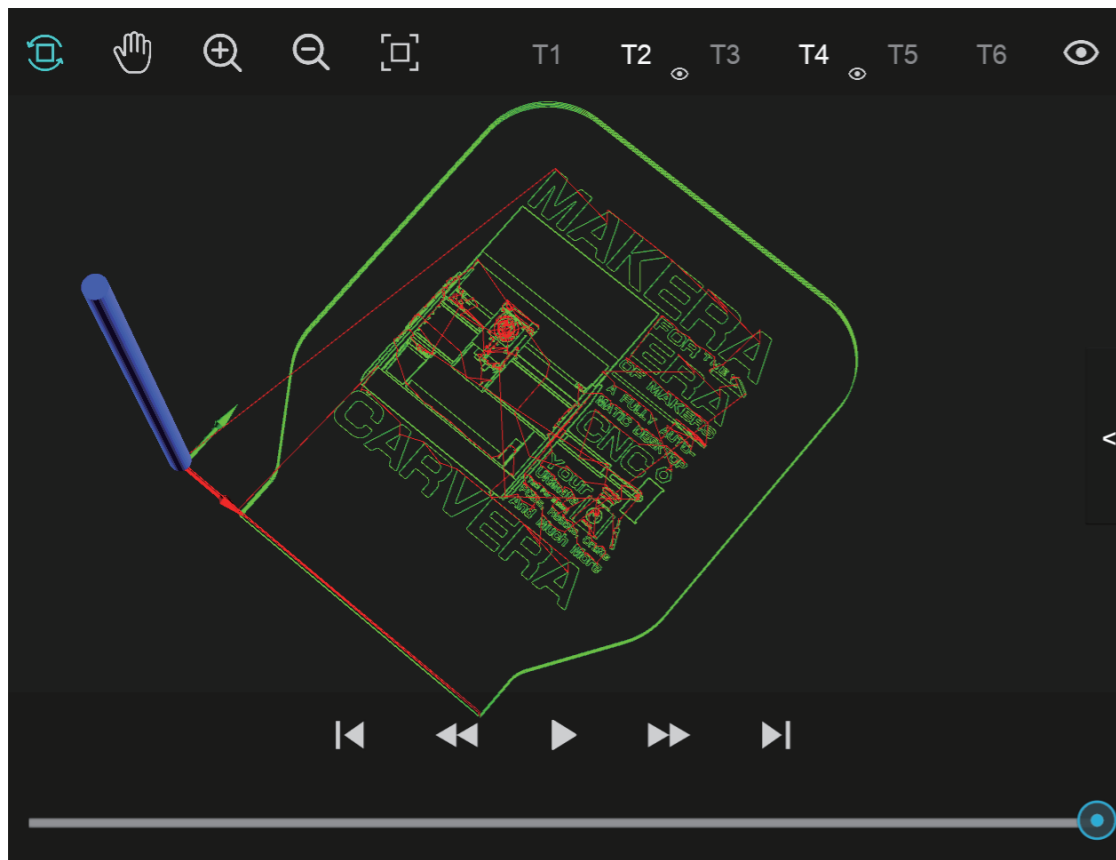

Manual Operation

1. Jogging control: Manually control the movement of the X/Y/Z axis and rotate the A axis at G0 fast speed (3000mm/min by default). You can set movement distance.

2. Status control: You can unlock, reboot or reset the device.

3. Automatic detection: Automatically scan the machining area; perform Z-axis probe or automatic leveling. The difference between here and the task configuration is that you can just apply one-time detection, without executing the G code file.

4. Move to the specified location: Provide a shortcut to quickly move to the specific location; including anchor points 1, 2, working zero points, G-code starting point, and clearance point (the upper right corner next to the machine zero points by default). You can quickly move the machine to there before cleaning the working surface after machining process end).

5. Set Origin: Manually set the work origin coordinates or use the manual probe to perform X, Y, and Z axis probing. See detailed introductions in the next chapter.

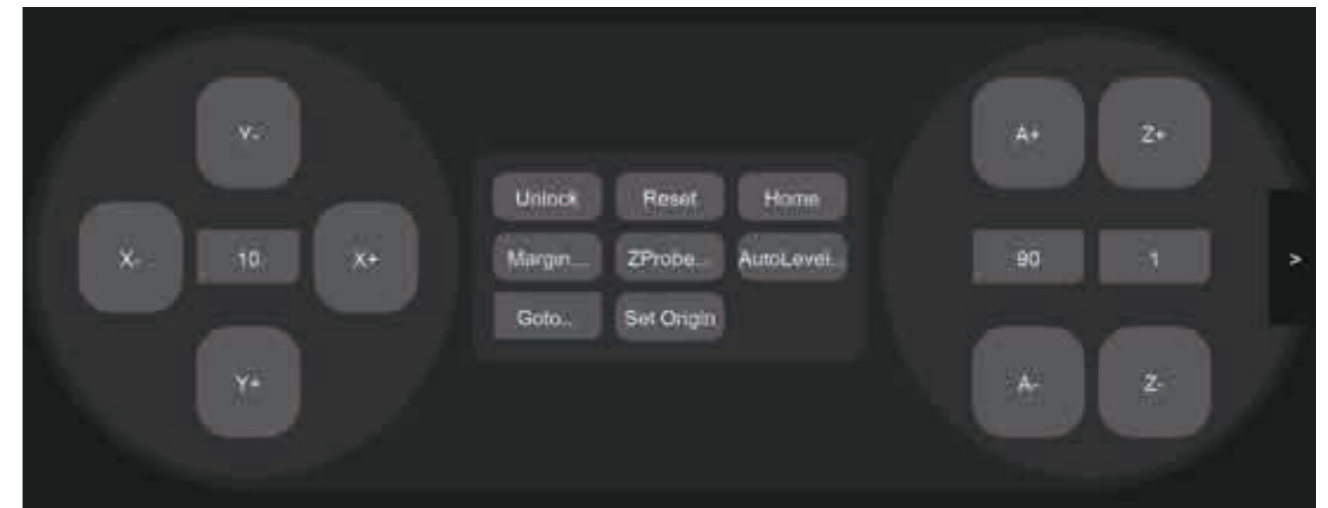

Errors

The device triggers an alarm when encountering an abnormal. Some alarms can be closed by unlocking. Some require rebooting the machine.

Alarm Type	Reboot	Causes
Halt Manually	No	Press emergency button on the machine or software
Home Fail	No	The return zero limit switch did not trigger
Probe Fail	No	Exceeded the maximum detection distance but has no signal
Calibrate Fail	No	Tool calibration probe malfunction
Spindle Overheated	No	Spindle overheating
Cover opened	No	The protective cover is opened during machining (cover detection enabled)
Wired Probe Error	No	No response from the Wired probe
Emergency Stop	No	Emergency stop is pressed
Hard Limit Triggered	Yes	Motion out of range
X/Y/Z Motor Error	Yes	X/Y/Z Servo motor block
Spindle Error	Yes	Spindle stall or other errors
SD card Error	Yes	SD card reading error
Machine Is Sleeping	Yes	Machine is sleeping

General Workflow

Different from the cumbersome operation process of general CNC, Carvera Air greatly simplifies the machining process. The general operation steps are as follows:

1. Turn on the Carvera Air device and wait for the homing to end.
2. Fix the workpiece to the anchor point.
3. Open the control software and connect to the device.
4. Upload and open the G-Code file.
5. Open the task setting box, and set the working zero point and automatic detection rules.
6. Start the job, and change tools when a tool change command is triggered and the machine prompts.
7. Wait until the machining process ends.

If you have any problems or enquiries, please feel free to contact us:

support@makera.com

Tool Kit Instruction



Wired Probe

The wired probe is a key component supporting Z-axis probing, machining boundary scanning, and automatic leveling.



1. Installation: It is stored on the right side of the spindle by default, and the cable has been connected and is ready for immediate use. The installation and removal method for the wired probe is the same as that for a standard milling bit.
2. Probing: When the wired probe is triggered, the green indicator light turns on.
3. Laser indicator: Press the wired probe twice to turn on the laser indicator (used for manual tool setting of the XY axis). The laser indicator will also be turned on automatically when probing, scanning boundaries, or auto-leveling.

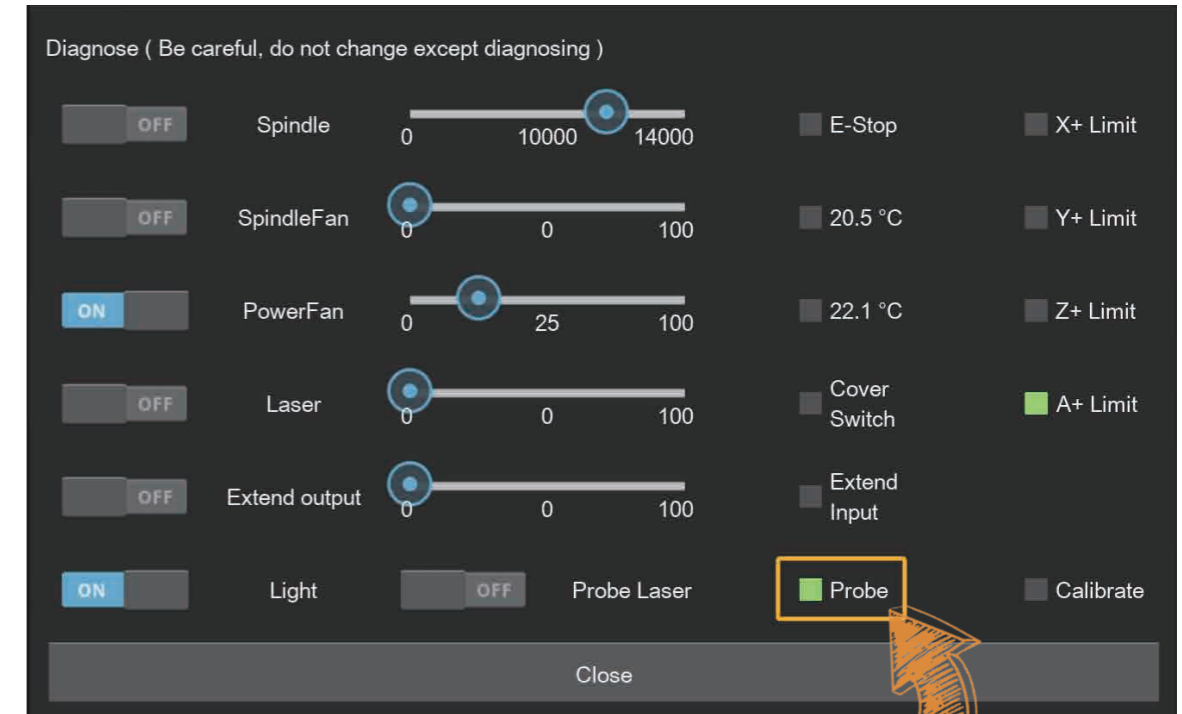

4. Test: Open the drop-down list in the status toolbar and select the diagnostic function, the diagnostic status dialog box will pop up. Press the wired probe and you can see the Probe signal is triggered, indicating the wired probe is working.

Note: Unlike the crash of milling bits, the crash of the wired probe may cause serious damage to the probe. Please use the wired probe with caution. Always observe its traveling path, and stop the machine when finding any obstacles to protect the wired probe.

Manual Probe

Use case: Normally, using the wired probe and the anchor-based positioning system is quite enough for most jobs. But when you need to place the workpiece not at the anchor point and need to accurately find the origin, you can use the manual probe.

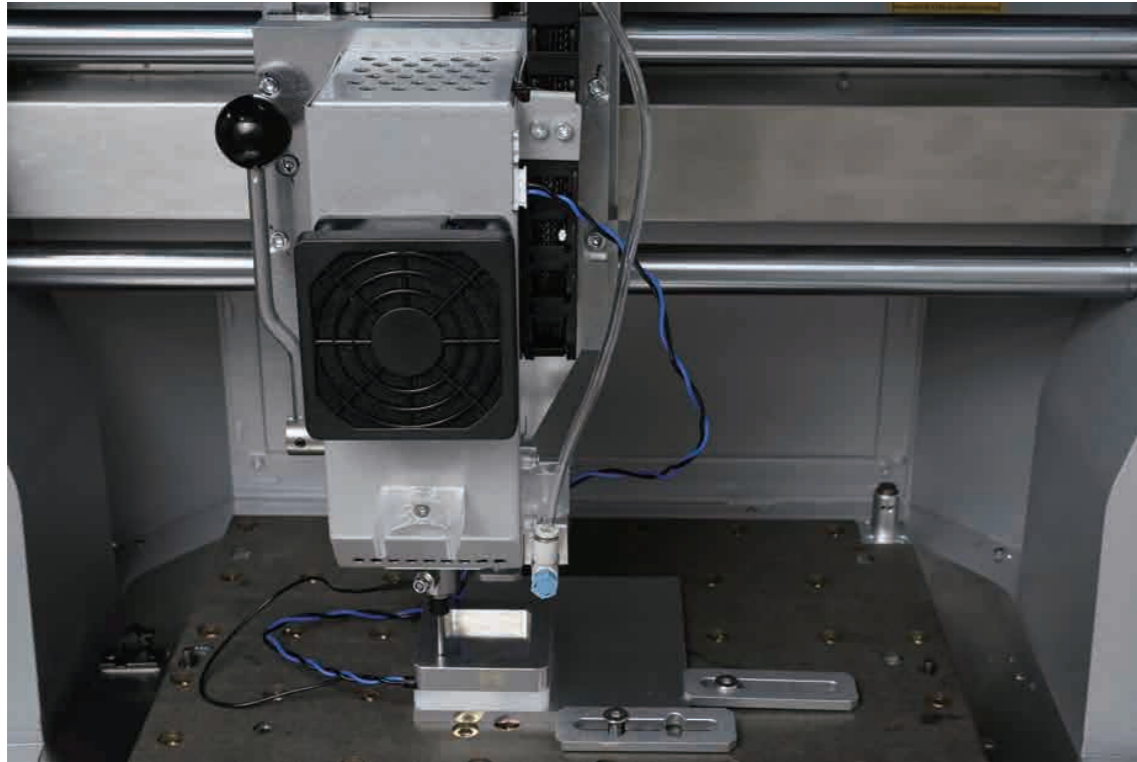

Usage:

1. Unplug the wired probe and plug the manual probe into the 4-pin socket on the top right of the spindle shell.
2. Place the manual probe (white plastic side) against the lower left corner of the workpiece firmly.
3. Move the machine and let the milling bit be positioned in the square area of the manual probe.
4. Attach the magnetic end of the manual probe to the spindle shaft as shown.
5. Click the 'Set Origin->Set By XYZ Probe' function, and set the height offset and the diameter of the milling bit. (It is recommended to use the 3.175mm diameter test rod we provided for probing so that the default parameters can be applied directly)

Auto-Set By Offset	Set By XYZ Probe
Probe Height: 9	Tool Diameter: 3.175
<i>Note: Please make sure the probe is stably positioned and the magnet head is attached to the tool.</i>	
Cancel	Ok

Note: Tip: The manual probe process will automatically set the origin of X, Y, and Z axes. There is no need to set them again.

Emergency Stop Button

Just like the main button in front of the Carvera Air machine, when any unexpected situation occurs, you can quickly press the emergency stop button to stop the machine, and the machine will stop immediately and enter the alarm state. You need to go to the control software to unlock the machine before continuing to use it. The emergency stop button has a self-locking function, just turn the emergency stop button clockwise to unlock it.





Workholding Tools

Workholding is one of the most important steps when using a CNC machine. Carvera Air provides two different workholding methods and corresponding tools to adapt to different types, shapes, and sizes of workpieces. While holding the workpiece, you can also locate the workpiece to the pre-defined position accurately by using Carvera Air's anchor-based system.

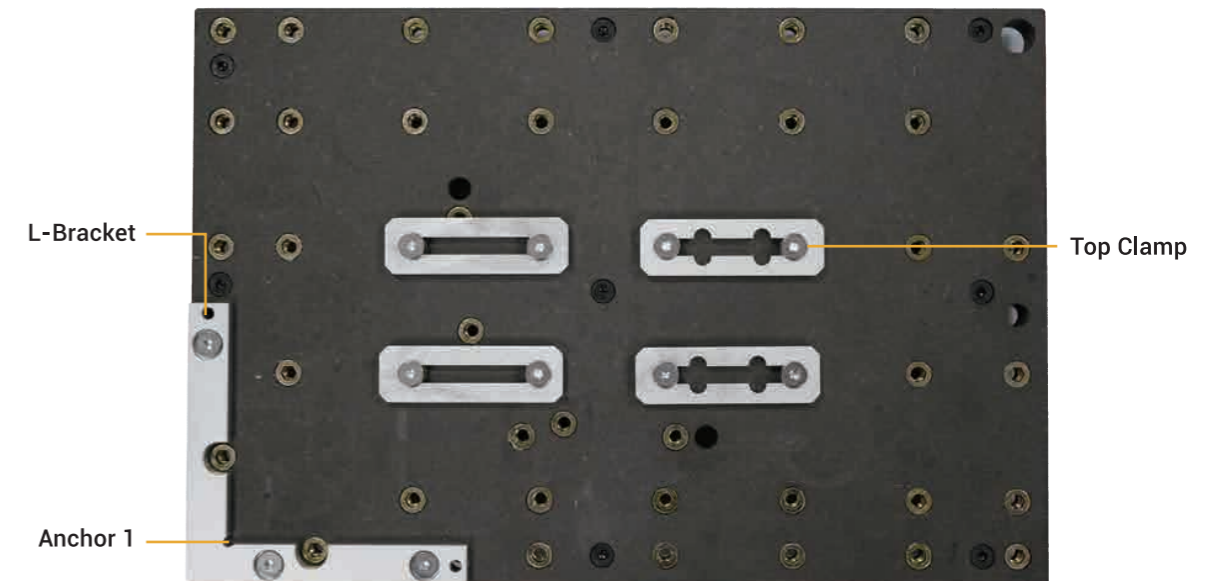

1. L-Bracket: Carvera Air provides a L-shaped bracket, which can be fixed at one of the two anchor points with two 4mm dowel pins and three M5 screws (the thick bracket uses long screws). The lower left corner is Anchor 1, and the middle position is Anchor 2. There are two semi-circular openings of the thin positioner, you can put two M5 screws to fix the lower-left corner of the workpiece there.

2. Top Clamps: The top clamp usually fixes the workpiece with a thickness of less than 2 cm together with the L-Bracket. The purpose of the top clamp with a cross groove is to facilitate the use of long sides to fix the workpiece. We recommend using shims at the end of top clamps to fix workpieces greater than 1 cm.

Note: The top clamp is not very thick, so please do not screw too tight.

Note: If you need to cut through a workpiece, we highly recommend placing a 1-2mm thick waste board (as the complimentary one) under the workpiece. This can avoid damage to the workbench.

Note: Please select corresponding length screws to fix different workpieces to avoid scratching the plate under workbench.

Bit Collar Installer

To better cooperate with Carvera Air's quick tool-changing mechanism (Limit the installation depth), the collar installer can be used to install collars when replacing new milling bits. The collar installer can do both installation and removal. (the collar is reusable).



Collar installation: As shown in the figure above, unscrew the front part of the installer. Insert the collar and the tool. Put in the installation metal ring (support 3.175/4/6/6.35mm). Loosen the tail pressure screw, screw back the front part, and tighten the tail pressure screw to complete the installation. After the installation is complete, the collar will be embedded with the tool, leaving a length of about 12mm at the tail for clamping.

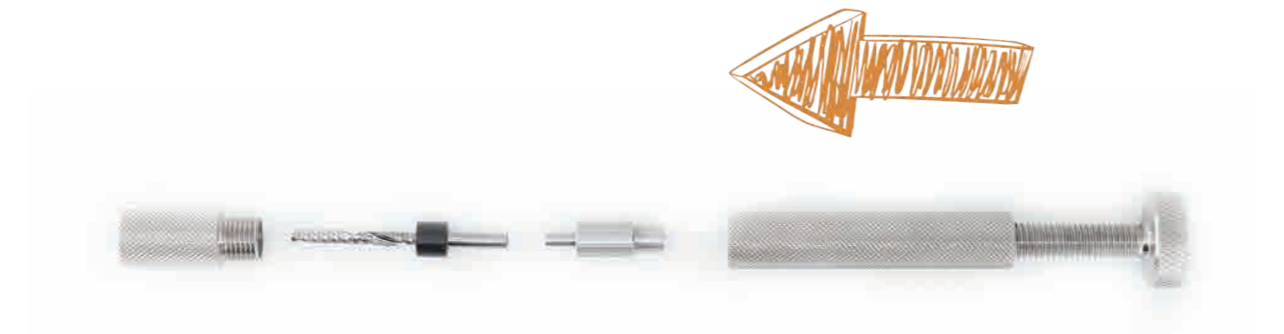

Collar removal: As shown in the figure above, unscrew the front part of the installer, put the tool with the collar. Put in the removal thimble, loosen the tail pressure screw, screw back the front part, tighten the tail pressure screw, and the removal is complete.

Note: The milling bits are sharp, be careful when install and uninstall collars.

Dust Collection Module

Chip evacuation is an important part of CNC but is usually ignored by other desktop-level CNC machines. Carvera Air provides a convenient way for you to attach an external vacuum.



1. Use cases: The primary factor in deciding whether to use the dust collection system is potential interference. If obstacles in the machining path block the dust shoe, do not use the dust collection system. Dust collection is ideal for machining thin and flat workpieces, such as plates. Avoid using dust collection when machining thick or irregular workpieces, or when utilizing the 4th axis.
2. Installation/Removal: Two fixed magnets are positioned above the dust shoe, allowing for easy magnetic installation and removal. The notch on the dust shoe aligns with the spindle shape for precise positioning. When not in use, the dust pipe can be secured into the upper latch.
3. Dust Extraction: Connect an external vacuum cleaner to the dust port on the rear of the machine (22mm inner diameter; an adapter may be required). You can manually start and stop the dust collection system.

Alternatively, you can automatically control the external dust collection equipment using the machine's external control port. For detailed instructions, please refer to the official knowledge base: <https://wiki.makera.com/>

Note: Installing the dust shoe may interfere with rapid tool changes. You can choose to remove the dust shoe during tool changes based on your usage preferences.

Note: Use caution when installing or removing the dust shoe, particularly if a milling bit is present in the spindle.

Spindle Collet Installer

Carvera Air comes with a 1/8 inch(3.175mm) spindle collet. This is the commonly used size for desktop-level CNC machines, which can meet most machining requirements. For special sizes such as 4mm/6mm/6.35mm, you can change the spindle collet and the tail shaft of the wired probe.



1. Change spindle collet: Use the handle to drop the current tool, insert the spindle collet installer into the current collet, and rotate counterclockwise to remove the current collet. Use the same way to install the new collet. (Do not over tighten)

2. Change the tail shaft of the wired probe: Rotate the wired probe's tail shaft counterclockwise to uninstall. Use the same method to change the new tail shaft. (Do not over tighten)



Air Assist Module

Use case: There are two main use cases for the air assist module. One is for chip removal and cooling during CNC machining, especially when machining metal materials. The second is to prevent the material from burning during laser engraving to improve the engraving quality.

Installation: An normal small air pump is more than enough for the Carvera air assist module, insert the 8 mm pipe into the plug at the back of the machine, and ensure that the air pipe is firmly fixed.

Air control:

1. Adjust the blue knob at the end of the air assist module to control the airflow, pull the knob to adjust, and press the blue knob to lock. Turn the knob clockwise to decrease the flow and counterclockwise to increase the flow.



2. The angle of the air nozzle can be adjusted to match different tool lengths and laser focus position.

Note: The air assist module and dust collection module cannot operate simultaneously. Please remove the dust shoe before using the air assist module. When the air assist module is not used for an extended period, turn off the air pump.

Rotary Module

1. Preparation: To facilitate transportation, the spindle box for the 4th axis is fixed in the right position. Refer to the illustration to loosen the four screws securing the spindle box. Carefully align the leftmost side of the 4th axis spindle box with the left side of the 4th axis base plate.

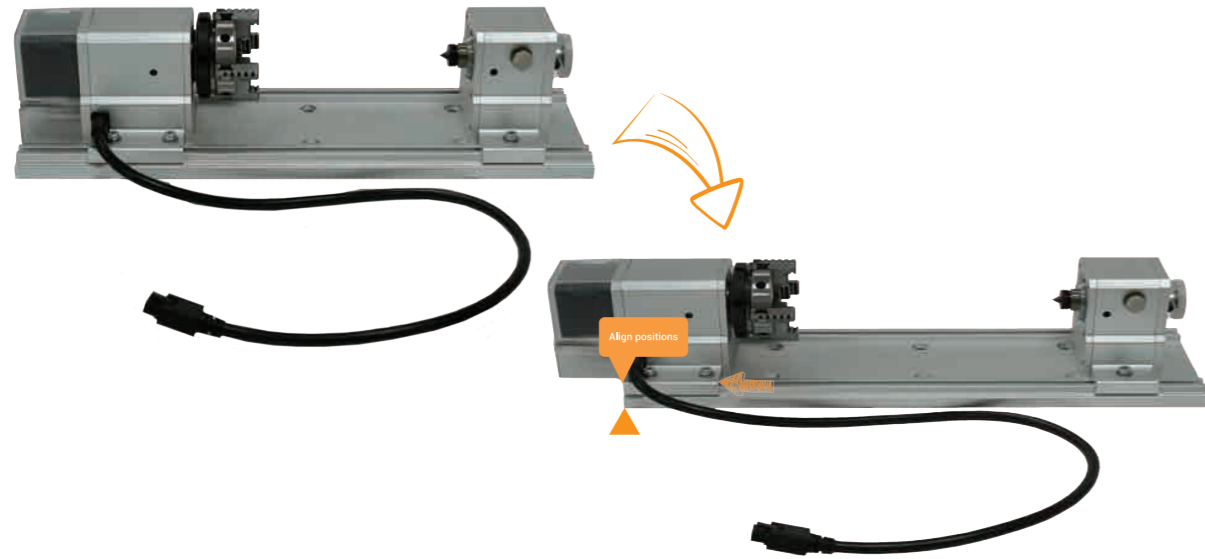

2. Installation:

2.1 Using two 4mm alignment pins, position the 4th axis at the center of the worktable as shown in the illustration. Fasten the 4th axis to the worktable with six M5×20 screws.

2.2 Ensure the machine is powered off before proceeding. Bend the 4th axis connection cable towards the rear inside the machine. Insert the cable into the 4th axis interface at position 1 in the illustration (ensure the dust cover at the interface is open first). Using the hex key and M4×8 screws provided in the 4th axis packaging, secure the cable clamp to position 2 shown in the illustration (remove the existing screws from the original position first).

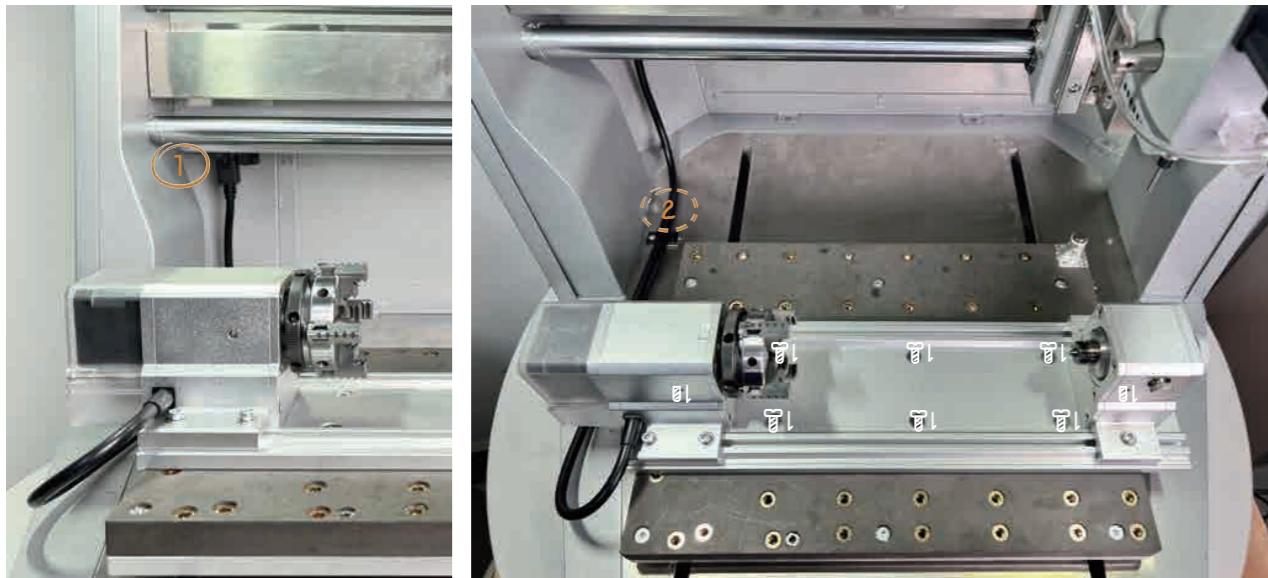

3. Workpiece holding:

- 3.1. Loosen the locking screw at position A on the tail stock as shown in the figure, adjust the tail stock tip to the right side by turning the knob counterclockwise.
- 3.2. Loosen the 2 fixing screws at position B.
- 3.3. Use two wrenches to adjust the opening size of the chuck and place the workpiece in.
- 3.4. Align the tail stock tip to the end of the workpiece, and tighten the two fixing screws at position B. (We highly recommend drilling a small hole at the end of the block tail for better holding strength, especially for hard materials.)
- 3.5. Use two wrenches to tighten the chuck, push the tail stock tip close to the workpiece by turning the knob clockwise, and lock the locking screw at position A. (Don't push too hard to the workpiece, it's ok when there is no gap and backlash, better drill a small hole first at the center of the workpiece tail for fixing.)

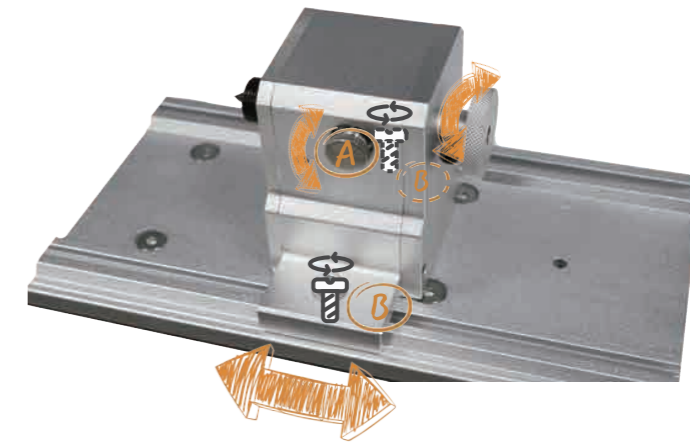

4. Software Settings: The right edge of the headstock is the reference point for setting the working coordinates of the rotary module. When performing rotary machining, you only need to set the distance between the X axis and the reference point and set Y to 0.

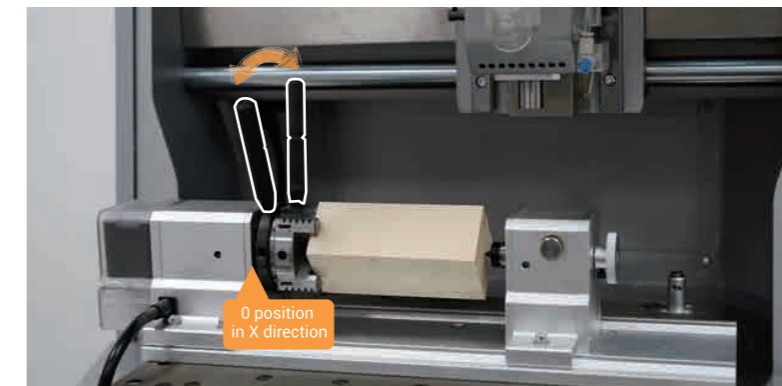

Note: Usually, you don't need to move the head stock, because the reference point on the head stock should be fixed for precise positioning. Ensure that the holding position/size/G-Code/work coordinate of the workpiece match with each other, otherwise it may cause damage to the module or tool bit.

Laser Module

The Carvera Air machine has an optional 5W diode laser module, which can engrave wood, plastic, and other materials, an excellent complement to the Milling function.



Installation/Removal: Insert the laser module as you would a standard milling bit, ensuring its orientation matches the direction indicated in the image. Confirm that the laser module does not rotate post-installation. Connect the cable to the laser module and to the 3-pin socket located at the top right of the spindle casing.

Optional - you can use the included silicone tube to connect the air inlet of the laser module to the air nozzle for Air Assist during laser processing, achieving better laser engraving results.



Note: The focal length of the laser module is fixed at approximately 5mm below the laser module (including the protective plate). Please ensure the material is flat, and make sure there are no obstacles higher than 5mm around the workpiece.

Note: Always wear laser protection goggles when using laser function.



CARVERA AIR



Feed & Speed

The following recommended parameters are based on current tests. The machining speed with small diameter tools/hard materials should be slow and fast in the opposite. We will conduct more tests and provide more detailed parameter recommendations in the future on our website.

Material	Tools	Milling depth (mm)	Feed Speed (mm/min)	Plunge speed (mm/min)	Spindle speed (RPM)
PCB	V-bit	0.1	200-500	200	12000
Wood	Single flute spiral bit	0.5-2	500-1000	300	10000
Plastic	Single flute spiral bit	0.5-2	500-1000	300	10000
Carbon/ Glass fiber	Corn bit	0.3-0.5	500-1000	300	10000
Aluminum/ copper	Single flute spiral bit for metal	0.1-0.2	300-500	200	12000



Note: Please start the test from the lower limit of the parameter, and adjust them based on the test results.

CAM

1. Summary

Carvera Air adapt standard G-Codes and is compatible with the open-source GRBL rules. Therefore, when using CAM software, select GRBL or standard G-Code should be all right. For laser engraving, you need to add sentences in front of the G-Code to switch to laser mode (M321), and return to the laser Z focus point (G0Z0), and add (M322) to exist laser mode after finished.

2. Software Recommendation

For Beginners: We recommend MakeraCAM as your CAM learning software. You can visit www.makera.com to learn more and download it.

For Experienced Users: If you are proficient with CNC, you can confidently use third-party CAM software such as Fusion 360, VCarve, etc.

Future Enhancements: We will continue to enhance the functionality of MakeraCAM and provide support for additional third-party CAM software.

Instruction Manual

www.makera.com

support@makera.com

