

INTRODUCTION

Thank you for choosing a De'Longhi product. Please take a few minutes to read these instructions. This will avoid all risks and damage to the appliance.

Symbols used in these instructions

Important warnings are identified by these symbols.

It is vital to respect these warnings. Failure to observe the instructions could result in electric shock, serious injury, burns, fire or damage to the appliance.



Danger!

Failure to observe the warning may result in life threatening injury by electric shock.



Important!

Failure to observe the warning could result in injury or damage to the appliance.



Please note:

This symbol identifies important advice or information for the user.

Troubleshooting and repairs

If the appliance requires repair, always contact the manufacturer's Customer Services.

Always insist on original spare parts.

Repairs carried out by unauthorised personnel may be dangerous and invalidate the guarantee.

IMPORTANT SAFEGUARDS

Fundamental safety warnings

Use this local air conditioner only as described in this instruction manual. As with all electrical equipment, whilst the instructions aim to cover as many eventualities as possible, caution and common sense should be applied when operating and installing this appliance.

This appliance is designed for home air conditioning and must not be used for other purposes.



Attention!

- This appliance can be used by children aged from 8 years and above and persons with reduced physical, sensory or mental capabilities or lack of experi-

ence and knowledge if they have been given supervision or instruction concerning use of the appliance in a safe way and understand the hazards involved. Children shall not play with the appliance. Cleaning and user maintenance shall not be made by children without supervision.

- Do not set heavy or hot objects on the appliance.



Danger! Since the appliance uses electricity, the following safety instructions must be followed:

- Modifying or changing the characteristics of the appliance in any way is dangerous.
- The appliance must be installed according to national laws governing electrical systems.
- For any repairs, always consult the Technical Service Centres authorised by the manufacturing company. Repairs performed by incompetent individuals can be hazardous.
- This appliance must be earthed. Have the electrical system checked by a qualified electrician.
- Avoid using extension cords.
- Before any cleaning or maintenance operation, always unplug from the mains.
- Do not pull on the electrical cord to move the appliance.
- Do not install the appliance in areas where the air may contain gas, oil or sulphur or near heat sources.
- If the power cable is damaged, it must be replaced by the manufacturer or the manufacturer's Customer Services in order to avoid all risk.



Please note:

- Clean the air filter at least once a week.
- When transporting, the appliance must be kept upright or resting on one side. Before transporting, drain all the water from the appliance. After transporting, wait at least one hour before turning on the appliance.
- Do not cover the appliance with plastic bags when stored.
- The packaging materials are recyclable. Please place them in the appropriate recycling collection containers.
- At the end of its life, deliver the local air conditioner to the appropriate collection centres.

Specific information regarding appliances with R290 refrigerant gas

- Thoroughly read all of the warnings.
- When defrosting and cleaning the appliance, do not use any tools other than those recommended by the manufacturing company.
- The appliance must be placed in an area without any continuous sources of ignition (for example: open flames, gas or electrical appliances in operation).
- Do not puncture and do not burn.
- Refrigerant gases can be odourless.
- The appliance must be installed, used and stored in an area that is greater than 4 m².
- This appliance contains R290 refrigerant gas.
(For more details on the refrigerant, see back cover).
- R290 is a refrigerant gas that complies with the European directives on the environment. Do not puncture any part of the refrigerant circuit.
- If the appliance is installed, operated or stored in a non-ventilated area, the room must be designed to prevent the accumulation of refrigerant leaks resulting in a risk of fire or explosion due to ignition of the refrigerant caused by electric heaters, stoves, or other sources of ignition.
- The appliance must be stored in such a way as to prevent mechanical failure.
- Individuals who operate or work on the refrigerant circuit must have the appropriate certification issued by an accredited organisation that ensures competence in handling refrigerants according to a specific evaluation recognized by associations in the industry.
- Repairs must be performed based on the recommendations from the manufacturing company. Maintenance and repairs that require the assistance of other qualified personnel must be performed under the supervision of an individual specified in the use of flammable refrigerants.
- The materials used for packaging can be recycled. You are therefore recommended to dispose of them in special differentiated waste collection containers.
- Do not use the appliance outdoors.
- Do not obstruct the entrances and exits of air.
- Do not use the appliance in laundry rooms.

GUARANTEE AND TECHNICAL ASSISTANCE

The conditions of the guarantee and technical assistance are given on the certificate supplied with your appliance.

TECHNICAL SPECIFICATION

Power supply voltage	see rating plate
Max. absorbed power during air conditioning	“
Refrigerant	“
Cooling capacity	“

Limit conditions:

Room temperature for air conditioning 21 ÷ 35°C

DISPOSING OF THE APPLIANCE



The appliance must not be disposed of with household waste, but taken to an authorised waste separation and recycling centre.



Please note: Transport, filling, cleaning, recovery and disposal of refrigerant should be performed by a technical service centre appointed by the manufacturer only. The appliance should be disposed of by a specialist centre appointed by the manufacturer only.

DESCRIPTION

- 1 air outlet grille
- 2 control panel
- 3 handles
- 4 castors
- 5 filter
- 6 evaporator air intake grille
- 7 air exhaust hose housing
- 8 condenser air intake grille
- 9 power cable
- 10 drain hose with 2 caps
- 11 flange with cap
- 12 air exhaust hose
- 13 hose adapter (2 pieces)
- 14 wall mounting accessory
- 15 window outlet
- 16 remote control unit (some models only)

USE

Electrical connections

Before plugging the appliance into the mains socket, check that:

- The mains power supply corresponds to the value indicated on the rating plate on the back of the appliance;
- The mains socket and electrical circuit are adequate for the appliance;
- The mains socket matches the plug. If this is not the case, have the plug replaced;
- The mains socket is adequately earthed. Failure to follow these important safety instructions absolves the manufacturer of all liability.

 **Danger!** The power cable must be replaced by a qualified professional only.

 **Important!** Before use, make sure the air intake and outlet grilles are unobstructed.

The instructions below will enable you to prepare your local air conditioner for operation as efficiently as possible.

Air-conditioning without installation

Just a few simple steps and your comfort is ensured with your local air conditioner:

- Screw one of the hose adapters **13** to one end of the air exhaust hose **12**.

- Fit the other adapter **13** to the air exhaust hose housing **7** at the back of the appliance (see fig. A).
- Screw the end of the hose without adapter to the adapter previously mounted on the appliance (see fig. A).

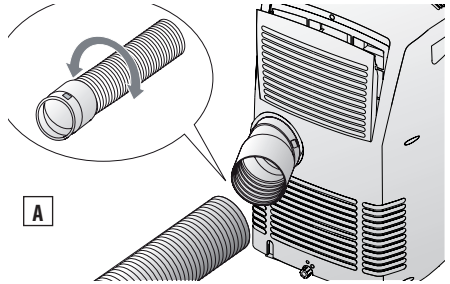

- Fit the window outlet **15** to the air exhaust hose **12** as shown in fig. B.

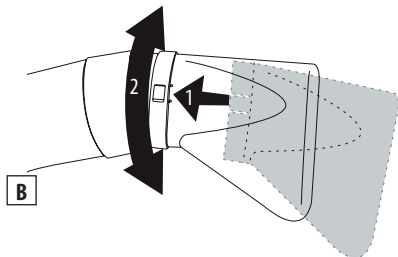

- Place the local air conditioner near a window or French window.
- Make sure the air exhaust hose is unobstructed.
- Open the window or French window slightly and position the outlet **15** as shown in figure C.

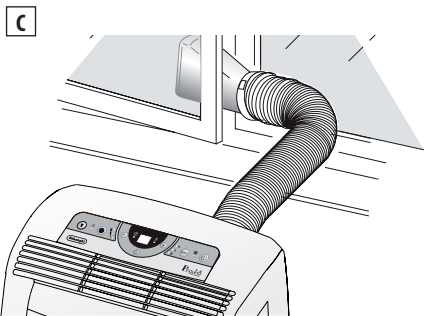

 **Important!** Keep the air hoses as short and free of curves as possible to avoid constrictions.

Air-conditioning with installation

If required, your appliance can also be installed semi-permanently (Fig. D).

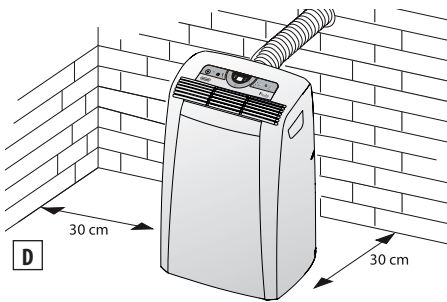

Proceed as follows:

- Drill a hole ($\varnothing 134\text{mm}$) in an outside wall or through a window pane. Respect the height and dimensions of the hole given in figure E.

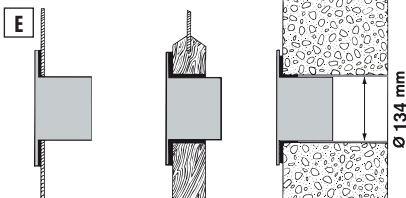

in the window pane

in the wooden kickboard of a French window

in the wall: you are recommended to insulate the section of wall using suitable insulation.

! **Important!** Keep the air hoses as short and free of curves as possible to avoid constrictions.

- Fit the wall flange accessory **11** provided in the hole.
- Fit the air exhaust hose **13** in the relevant hose **7** located on the rear side of the appliance (see fig. A).
- Screw the wall mounting accessory **14** from the air exhaust hose **12** or, if necessary, unscrew the hose adapter **13** from the air exhaust hose **12** and replace it with the wall installation terminal **14** (fig. F).

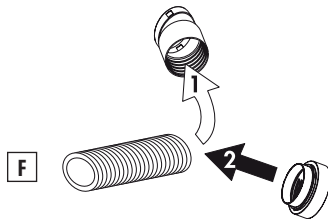

- Insert the other end of the hose **12** on the flange **11** as shown in fig. G.

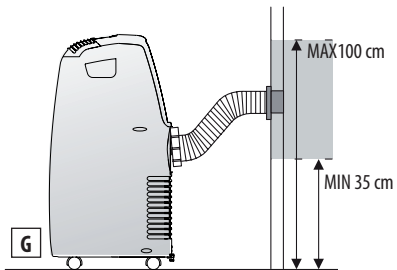

- When the hose **12** is not fitted, the hole can be closed with the flange cap **11**.

i **Please note:** When installing the local air conditioner semi-permanently, you should leave a door slightly open (as little as 1 cm) to guarantee correct ventilation.

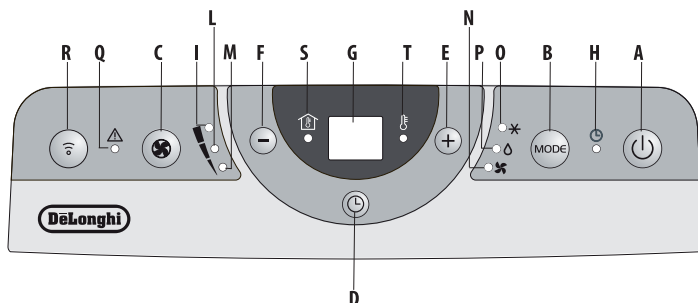

Description of the control panel

- A** ON/STAND-BY button
- B** MODE selection button
Air conditioning, dehumidifying, fan.
- C** Fan speed selection button
(MAX/MED/MIN)
- D** Timer button
- E** Programmed operation increase temperature/time button
- F** Programmed operation decrease temperature/time button
- G** Display: Displays the temperature values set, room temperature and the programmed operating time
- H** Timer in operation indicator light
- I/L/M** Fan speed lights
(MAX/MED/MIN on some models)
- N** Fan mode light
- O** Air-conditioning mode light
- P** Dehumidifying mode light
- Q** Alarm light
- R** Remote control signal receiver
- S** Light: displays room temperature
- T** Light: displays set temperature

! **Important!** Never turn the local air conditioner off by unplugging from the mains. Always press the button, then wait for a few minutes before unplugging. This allows the appliance to perform a cycle of checks to verify operation.

OPERATION

Turning the appliance on

i **Please note:** Before plugging the appliance check: the caps on the back of the unit are correctly inserted and screwed on the drainage hose 10.

Plug the appliance into the mains. Press the **ON/STAND-BY** button (**A**) (when turned on, the local air conditioners starts operating in the same mode as when it was turned off). The display shows the room temperature. Press the **MODE** button (**B**) until the indicator light corresponding to the required mode lights up:

- Light (**O**): air-conditioning mode
- Light (**N**): fan mode
- Light (**P**): dehumidifying mode

Air-conditioning mode

Ideal for hot humid weather when you need to cool and dehumidify the room. By default, the room temperature is displayed. Light (**S**) is on. To set the required temperature, press the + (**E**) or - (**F**) buttons until the required temperature is displayed (to switch between °F and °C, press the **E** and **F** buttons together for a few seconds). Light (**T**) comes on and light (**S**) goes off. Fifteen seconds after setting the temperature, the display switches back to room temperature. Light (**S**) comes on again. You can adjust temperature in air conditioning mode only. Then select the fan speed by pressing the **FAN** button (**C**) until the indicator light corresponding to the required fan speed lights up:

- MAX:** the local air conditioner operates at maximum to reach the required temperature as rapidly as possible.
- MED:** reduces noise levels but still maintains a good level of comfort

 for silent operation

Please note: *The most suitable temperature for the room during the summer varies from 24 to 27°C. You are recommended, however, not to set a temperature much below the outdoor temperature.*

Fan mode

Adjust fan speed by pressing the FAN button (C) as described for the air-conditioning mode. Remember that the higher the speed, the more air is filtered. If you select "MIN" speed, less air is filtered but the appliance is also less noisy.

Dehumidifying mode

Ideal for reducing the humidity in a room (spring or autumn, damp rooms, rainy spells, etc). When the dehumidifying mode is selected, the light (P) comes on. At the same time, the "MIN" fan speed light (M) comes on. In this mode, other speeds cannot be selected.

 **Please note:** remember to fit the air exhaust hose as described in the chapter "Preparing for use".

Programming the timer

The timer can be used to delay appliance start up or shut down. This avoids wasting electricity by optimising operating periods.

How to programme delayed start up

- Plug the appliance into a mains socket and press the **ON/STAND-BY** button (A), then select the required operating mode and other settings (temperature, fan speed, etc).
- Press the **ON/STAND-BY** button (A) again to place the appliance in standby mode.
- Press the timer button (D). The timer light "H" flashes.
- Use the + (E) or - (F) buttons to set the number of hours delay before the appliance comes on.
- The time increases or decreases in steps of one hour.

The indicator light (H) flashes until the appliance starts up. You can set the appliance to come on with a delay of up to 24 hours. To cancel the timer programme, press the timer button (D) again. Light (H) stops flashing.

How to programme delayed shut down

- Delayed shut down can be programmed in any operating mode (air conditioning / fan/ dehumidifying).
- Press the timer button (D). The timer light "H" flashes.

- Use the + (E) or - (F) buttons to set the number of hours delay before the appliance goes off.

The time increases or decreases in steps of one hour. The light (H) flashes until the appliance turns off as programmed. At the set time, the local air conditioner shuts down and remains in standby. To cancel the timer programme, press the timer button (D) again. Light (H) stops flashing.

USING THE REMOTE CONTROL UNIT

Models with remote control

- Point the remote control at the receiver on the air-conditioner (see fig. H). The remote control must be no more than 5 metres away from the appliance (without obstacles between the remote control and the receiver).
- The remote control should be handled with **extreme care and respect**. Do not drop it, expose it to direct sunlight, or leave it near sources of heat.

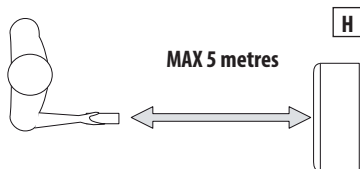

Description of the remote control

- 17) "ON/STAND-BY" button
- 18) "MODE" button
- 19) Programmed operation/ decrease/increase temperature button
- 20) "TIMER" button
- 21) Fan speed selection button (MAX/MED/MIN)
- 22) °F/°C switching button

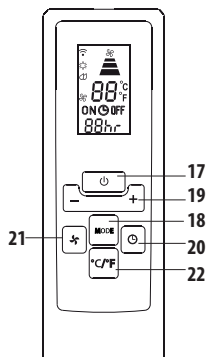

Replacing the batteries

- Remove the cover on the rear of the remote control;
- Replace the old batteries with two new LR03 "AAA" 1.5V batteries, inserting them correctly (see the instructions inside the battery compartment);
- Replace the cover.

i **Please note:** If the remote control unit is replaced or discarded, the batteries must be removed and disposed of in accordance with current legislation as they are harmful to the environment. Do not mix alkaline, standard (zinc-carbon) and rechargeable (nickel-cadmium) batteries. Do not throw the batteries in the fire as they could explode or leak dangerous liquids.

Turning the appliance on

Plug the appliance into the mains. Press the **ON/STAND-BY** button (17) (when turned on, the local air conditioner starts operating in the same mode as when it was turned off). Press the **MODE** button (18) to select the required mode:

COOLING

DEHUMIDIFYING

FAN ONLY

On the control panel, the light corresponding to the selected mode comes on. For air conditioning/dehumidifying/fan only settings and programming the timer, see page 17-18.

TIPS

To get the best from your local air conditioner, follow these recommendations:

- Close the windows and doors in the room to be air conditioned. The only exception is when the appliance is installed through a hole in the wall. In this case, you are recommended to leave a slight draught through a door or window to guarantee correct ventilation (see Fig. I).

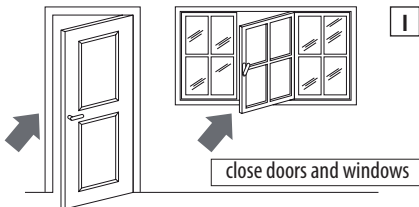

- Protect the room from direct exposure to the sun by partially closing curtains and/or blinds to make the appliance much more economical to run (see fig. J);

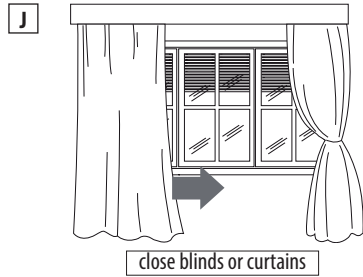

- Never rest objects of any kind on the air conditioner (see fig. K);

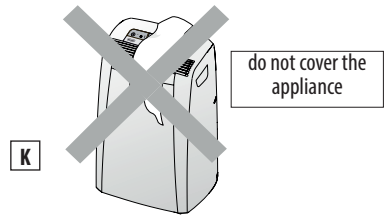

- Never obstruct the air intake **6** or outlet **1** grilles;
- Make sure there are no heat sources in the room.
- Never use the appliance in very damp rooms (laundries for example).
- Never use the appliance outdoors.
- Make sure the local air conditioner is on a level floor.

CLEANING

Before cleaning or maintenance, turn the appliance off by pressing the ON/STAND-BY button (A) or in models with remote control unit, by pressing the ON/STAND-BY button (17), then always unplug the appliance from the mains socket.

Cleaning the cabinet

You should clean the appliance with a slightly damp cloth then dry with a dry cloth. For safety reasons, never wash the local air conditioner with water.

Precautions

Never use petrol, alcohol or solvents to clean the appliance. Never spray insecticide liquids or similar.

Cleaning the air filters

To keep your local air conditioner working efficiently, you should clean the dust filter every week of operation. The filter is housed in the intake grille. To clean the filters, remove the

filter as shown in figure L.

L

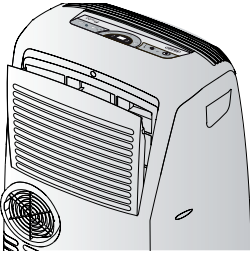

Use a vacuum cleaner to remove the dust collected on the filter. If it is very dirty, immerse in warm water and rinse a number of times. The water should never be hotter than 40°C. After washing, leave the filter to dry. Put the filter back in its housing.

Start of season checks

Make sure the power cable and plug are undamaged and the earth system is efficient. Follow the installation instructions precisely.

End of season operations

To drain all water from the circuit, first unscrew in the anticlockwise direction the external cap from the drain hose on the back of the appliance then remove the internal cap (figure M) and allow the water to drain out into a basin. When all the water has been drained, close the hose with the 2 caps. Clean the filter and leave it to dry before putting it back in its housing.

M

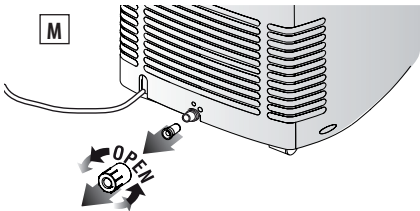



TROUBLESHOOTING

PROBLEM	CAUSE	REMEDY
The local air conditioner does not come on	<ul style="list-style-type: none"> no electricity it is not plugged into the mains the safety device has tripped 	<ul style="list-style-type: none"> wait plug into the mains contact your service centre
The local air conditioner works for a short time only	<ul style="list-style-type: none"> the air exhaust hose has a constriction the air exhaust hose is blocked there are bends in the air exhaust hose 	<ul style="list-style-type: none"> position the exhaust hose correctly check there are no obstacles obstructing air discharge eliminate the bends
The local air conditioner works, but does not cool the room	<ul style="list-style-type: none"> window open there are heat sources in the room (burner, lamp, etc) the exhaust hose is detached air filter clogged the local air conditioner is not powerful enough for the conditions or size of the room 	<ul style="list-style-type: none"> close the window eliminate the heat source connect the exhaust hose clean or replace the filter
Particular odour in the room	<ul style="list-style-type: none"> air purifying filters clogged 	<ul style="list-style-type: none"> clean or replace the filters
The local air conditioner does not operate for about 3 minutes after turning it on	<ul style="list-style-type: none"> the safety device has tripped 	<ul style="list-style-type: none"> wait for three minutes
The alarm light Q comes on	<ul style="list-style-type: none"> the tank inside the appliance is full. 	<ul style="list-style-type: none"> empty the tank (see "End of season operations) on page 20).

Self-diagnosis

The appliance has a self diagnosis system to identify a number of malfunctions. Error messages are displayed on the appliance display.

IF IS DISPLAYED	IF IS DISPLAYED	IF IS DISPLAYED
 <p>“Low Temperature”</p>	 <p>“High Temperature”</p>	 <p>“Probe Failure” (sensor damaged)</p>
MEANS: room temperature is too low	MEANS: room temperature is too high	MEANS: contact your local customer service