



Send Us a Text: 1-812-652-2525
(US and Canada Only. Carrier Fees May Apply)



Find Us Online: www.maxicosi.com
Email Us: support@djgusa.com



Give Us a Call: 1-800-951-4113
(Toll Free, US and Canada Only)



Replacement Parts List

(on select models)

- Seat Pad Set
- Removable Cup Holder(s)
- Lower Anchor Belt
- Locking Clip
- Instructions

For parts availability and questions, call, text, or chat.

If requested color is not available, similar color will be substituted.

Applicable tax and shipping & handling will also be added.

Andi 360°

Rotating All-in-One Convertible Car Seat

Your model may look different than one shown on cover.

Read all instructions BEFORE USING this car seat.

KEEP INSTRUCTIONS FOR FUTURE USE.

⚠ Failure to follow the warnings on the labels and in the instruction manual can result in serious injury or death to your child. Serious injury may include paralysis and/or permanent brain injury.

4358-8670 04.04.25

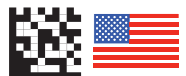

Welcome to the Maxi-Cosi Family!

Thank you for choosing this car seat, also known as a child restraint!

To help you get started using your child's new car seat, here are the 4 main tasks you'll need to complete.

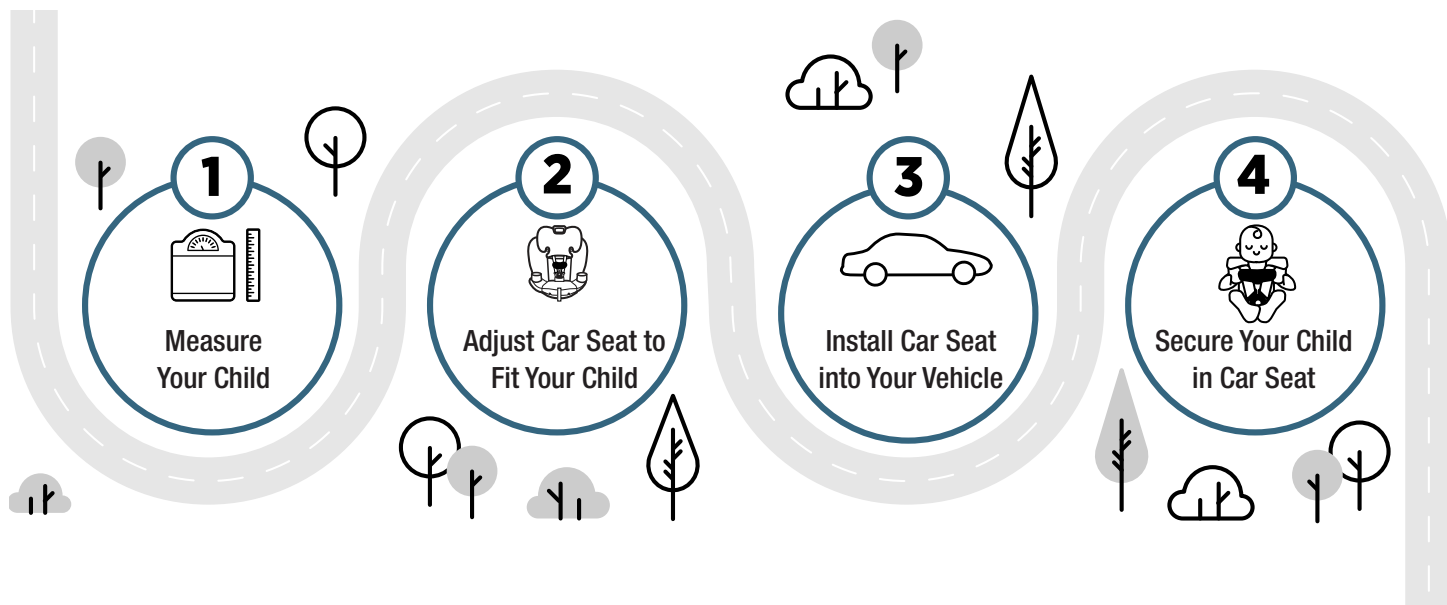

SCAN HERE
FOR INSTALL
VIDEOS



Your child's safety is worth the time it will take to read and follow these instructions.

Ready? Let's go!

Pages 1–4 will introduce you to the parts of the car seat.

The Back Cover of this Manual has our contact information.

If at any point you would like assistance, please feel free to reach out to us.

Contents

1 Getting Started

- 1 Parts of Car Seat
- 3 Accessory Use
- 5 Installing Base with Vehicle Belt
- 9 Installing Base with LATCH: Lower Anchor Belt
- 13 Choosing Car Seat Mode
- 15 Rotating and Reclining Car Seat on Base

17 Rear-Facing Mode

- 19 **Rear-Facing** Child Fit

24 Forward-Facing Mode

- 26 **Forward-Facing** Child Fit

31 Securing Child in Car Seat

35 Booster Seat Mode

- 37 Storing Harness System
- 42 **Booster Seat** Use in Vehicle

46 Making Adjustments to Car Seat

- 46 Changing Headrest/Harness Height
- 47 Changing Buckle Position

49 Wash and Care

- 49 Removing Seat Pad Set
- 52 Cleaning Parts of Car Seat and Installing Seat Pad Set

53 LATCH and Vehicle Belt Information

- 53 LATCH: Lower Anchor Belt
- 55 Vehicle Belts
- 59 Top Tether

60 Safety Information

- 60 Child Restraint Use
- 61 Vehicle Seating Position
- 62 Installation in Vehicle
- 63 Replacement and Expiration
- 64 Registration and Safety Notices
- 65 Aircraft Information

65 Warranty

©2025 Dorel Juvenile Group, Inc. (800) 951-4113 www.maxicosi.com.
Styles and colors may vary. Les styles et les couleurs peuvent varier.
Made in China. Fabriqué aux CHINA. Distributed by (distribué par) Dorel Juvenile Group, Inc.,
2525 State St., Columbus, IN 47201-7494.
Dorel Juvenile Canada, 2233 Argentia Road, Suite 110, Mississauga, ON L5N 2X7.
Importado y Distribuido en Chile por: Comercial e Industrial Silfa S.A. - San Ignacio
0201 / Parque Industrial Portezuelo Quilicura, Santiago Chile. Fono (562) 2339 9000. En
Perú por: Comexa S.A. - Los Libertadores 455 – San Isidro, Lima – Perú. Fono
(511) 4469014. En Centro América, Caribe y Ecuador por: Best Brands Group S.A. – Av.
Balboa, Bay Mall Plaza, Planta Baja, local 9, Panamá. - Fono: (507) 300 2884.
En Colombia por: Baby Universe S.A.S. Vía 40 No. 77-29,
Barranquilla, Colombia - Fono: (575) 353 1110 Importador: DJGM,
S.A. DE C.V. Gabriel Mancera No. 1041 Col. Del Valle, Benito Juárez
C.P. 03100 México, Ciudad de México R.F.C. DJG140305GN9
Tel. (55) 67199202



Parts of Car Seat

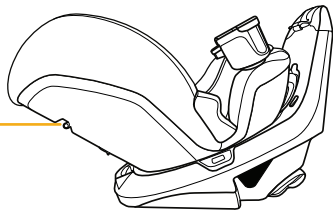
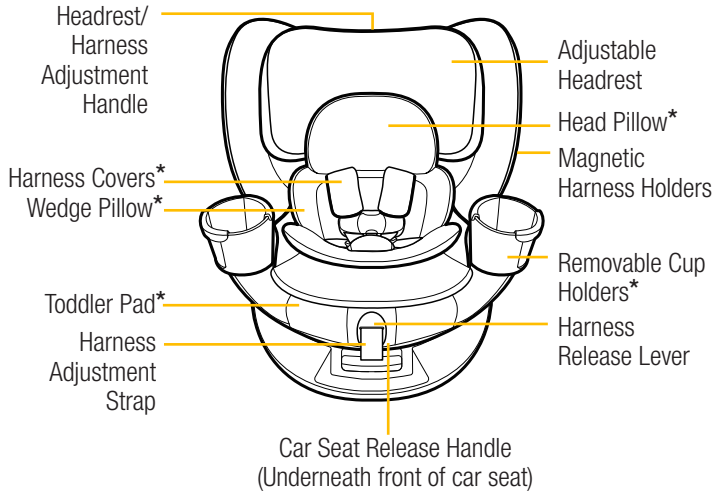

Harness System

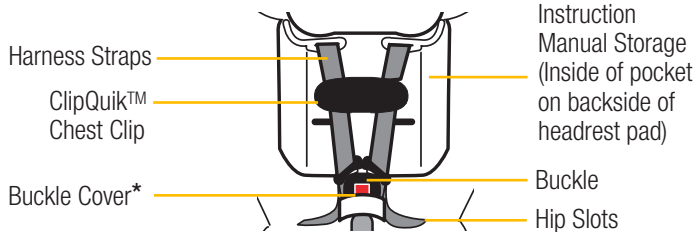

Your model may look different than one shown.

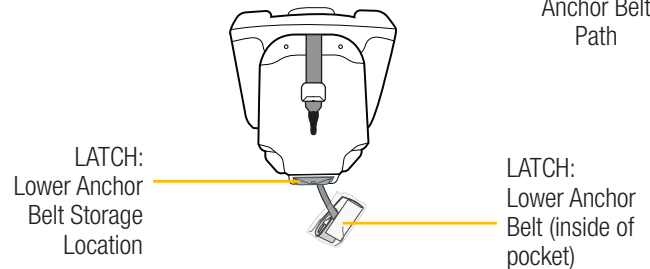
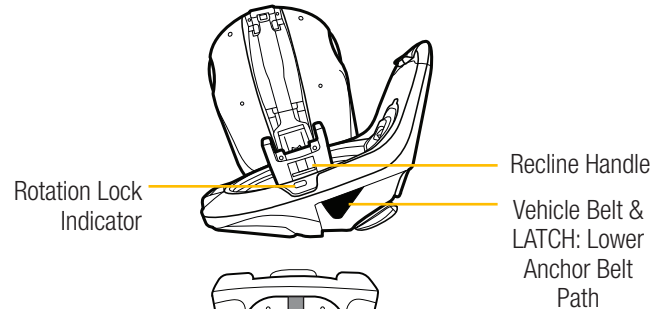
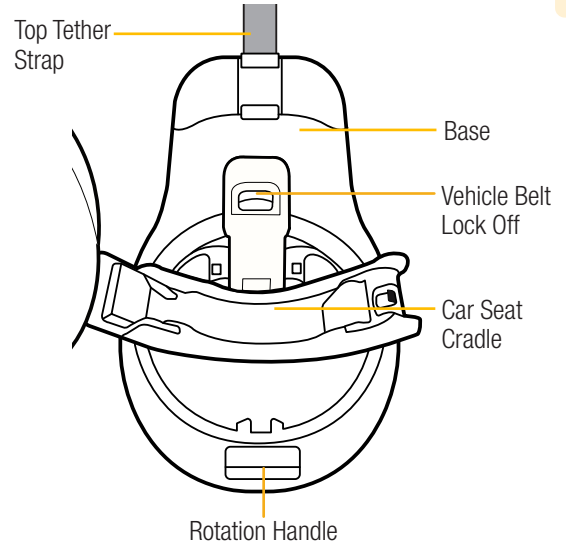

*See pages 3–4 for Accessory Use.

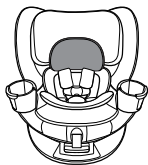

Head Pillow
(on select models)
**Only For Use in
Rear-Facing Mode**

To remove head pillow, from the back of the head pillow gently pull the fabric tabs out from around the harness straps.

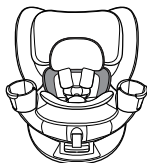

Body Pillow
(on select models)
**Only For Use in
Rear-Facing Mode**

To remove body pillow, undo the buckle and pull it through the slot in the pillow. Slide the pillow out from behind the harness straps.



Toddler Pad
(on select models)
**For Use in Rear-Facing
Mode or Forward-Facing
Mode up to 40 lb (18 kg)**

To remove toddler pad, undo the buckle and fasteners on pad. Then pull it through the slot in the pillow.



**Removable Cup
Holder(s)**
(on select models)

For Use in All Modes

**The cup holder(s) is top-rack
dishwasher safe.**

To remove cup holder, twist the cup holder counterclockwise. Pull it out of the slot in the car seat.

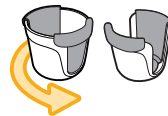

For a larger cup, twist the cup holder insert counterclockwise as shown.



Buckle Cover
(on select models)

**For Use in
Rear-Facing Mode or
Forward-Facing Mode**

To remove, undo the buckle and pull the buckle cover off the buckle.

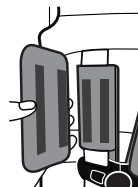

Harness Covers
(on select models)

For Use in All Modes

The harness covers help provide comfort to your child's neck.

To remove, undo the harness, pull the fastening strips apart and pull the harness covers off of the top part of the harness cover. The bottom part is not removable.

Installing Base with Vehicle Belt

⚠️ WARNING

DO NOT use both the LATCH: lower anchor belt and vehicle belt at the same time to install the car seat. The car seat is attached to the base via cable wires and should **NOT** be removed.

When top tether anchors are available, you **MUST ALWAYS** attach, adjust, and secure the tether (top anchorage) strap when installing the car seat in all modes.

DO NOT leave child restraint in Side-Facing mode while vehicle is in motion.

Even when unoccupied, this child restraint **MUST** be firmly secured to the vehicle with the lower anchor belt or with the vehicle seat belt in Rear-Facing or Forward-Facing mode.



Before installing the car seat in your vehicle, check if the buckle position needs to be adjusted for your child.

See page 21 for **Rear-Facing** buckle positions.

See page 28 for **Forward-Facing** buckle positions.

Review Vehicle Owner's Manual

Determine the type of vehicle belts in your car and how to use them to lock a car seat in place **OR** where LATCH: lower anchor seating positions are located in your vehicle.

For LATCH Belt, go to page 9.

1

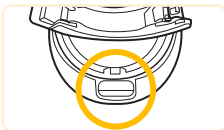

Place Base in Vehicle Seat

The car seat base **MUST** be flat on the vehicle seat.

Squeeze the rotation handle and swivel the seat to face you in side view.

Squeeze the release handle located on the front of the car seat while lifting the car seat off the base and flipping it over to the opposite side.

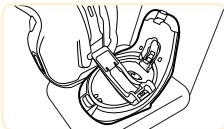

2

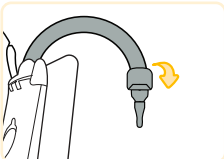

Loosen Tether Strap

Lift the tether adjuster to loosen the strap. Or, if your seat has an adjuster with a button, then squeeze the adjuster button and pull the strap to loosen as shown.



3

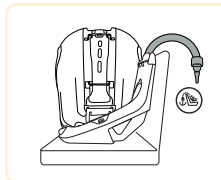

Lay Top Tether Strap Over the Vehicle Seat

You will be installing the top tether strap in steps 8–9.

Review the vehicle owner's manual for the tether anchor locations.



When using the passenger or driver side locations in **Rear-Facing** mode, the car seat **MUST** be touching the back of the vehicle seat in front of it, or be as close as possible.

For Lap Belt only, skip Step 4 and leave lock off closed.

4

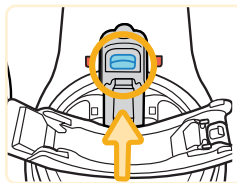

Open Belt Lock Off

Squeeze the lever to open the belt lock off and pull it forward.

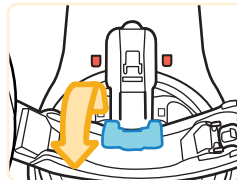

5

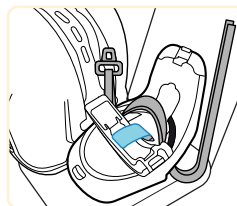

Weave Vehicle Seat Belt In and Out of Belt Path As Shown

Buckle the vehicle belt.



6

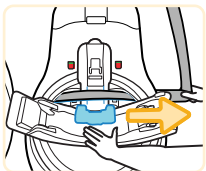

Tighten Belt and Gently Remove Slack

Place your hand in the base and firmly push the base down and back toward the vehicle seat. Pull the belt parallel (in line) with the belt path as shown.

7

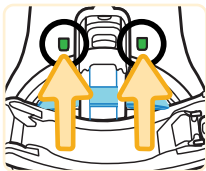

Close Belt Lock Off

Both indicators will turn completely green when vehicle belt is properly installed.

i

If your car has a vehicle belt that can switch to locking mode, you **MUST** use it to lock the belt.

Switching vehicle belt to locking mode: Slowly pull the shoulder belt all the way out, then let it retract 1–2 in. (2.5–5 cm).

As it retracts, you will most likely hear a ratcheting sound.

Gently pull the belt to see if it has locked. You will not be able to pull any more belt out if the lock has engaged.

8

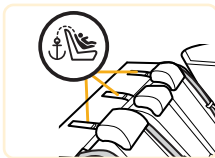

Locate Vehicle Tether Anchors

Locations vary by vehicle. Review your vehicle owner's manual for top tether anchor locations and how to route the tether belt when there are vehicle headrests.

9

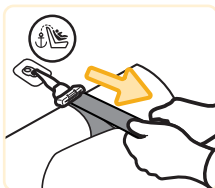

Attach and Tighten Top Tether Strap

i

If the base moves more than 1 in. (2.5 cm) side to side at the belt path, you can try:

- Pulling the belt tighter; **OR**
- Reinstalling the base; **OR**
- Changing to a different seating location; **OR**
- Switching to a different install method (LATCH: Lower Anchor Belt).

FINISHED!

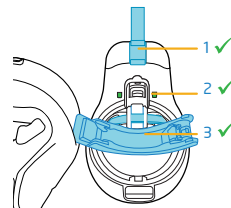

1. Tether Installed? If it is not installed, see steps 8–9.

2. Belt Tension Indicators Completely Green?

If they are not green, see steps 4–7.

3. Car Seat Cradle Side-Facing As Shown? If it is not side-facing, squeeze the rotation handle and move it into side-facing position.

Rear-Facing Child Fit: See pages 19–23.

Forward-Facing Child Fit: See pages 26–30.

Booster Seat Use in Vehicle: See pages 42–45.

When using the passenger or driver side locations, the car seat **MUST** be touching the back of the vehicle seat in front of it, or be as close as possible.

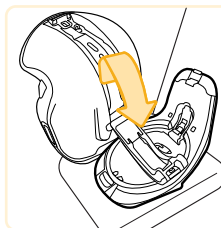

Flip Car Seat Over
Push down on the front of the car seat to lock into place.

Installing Base with LATCH: Lower Anchor Belt

⚠️ WARNING

DO NOT use both the LATCH: lower anchor belt and vehicle belt at the same time to install the car seat. The car seat is attached to the base via cable wires and should **NOT** be removed.

When top tether anchors are available, you **MUST ALWAYS** attach, adjust, and secure the tether (top anchorage) strap when installing the car seat in all modes.

DO NOT leave child restraint in Side-Facing mode while vehicle is in motion. Even when unoccupied, this child restraint **MUST** be firmly secured to the vehicle with the lower anchor belt or with the vehicle seat belt in Rear-Facing or Forward-Facing mode.

i

Before installing the car seat in your vehicle, check to see if you need to adjust the buckle position for your child.

See page 21 for **Rear-Facing** buckle positions.

See page 28 for **Forward-Facing** buckle positions.

If LATCH: lower anchors are not an option or if your child weighs more than **30 lb** (13.6 kg), in **Rear-Facing Mode** or **35 lb** (15.9 kg) in **Forward-Facing Mode** you **MUST** use the vehicle seat belt system to install the car seat.

Review Vehicle Owner's Manual

Determine what kind of vehicle belts your car has and how to use them to lock a car seat in place **OR** where LATCH: lower anchor seating positions are located in your vehicle.

1

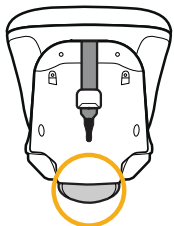

Take Lower Anchor Belt Out of Storage Location

Remove the lower anchor belt from the pouch on the base. For more information, see page 53, LATCH: Lower Anchor Belt.

2

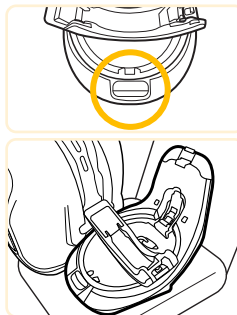

Place Base in Vehicle Seat

The car seat base **MUST** be flat on the vehicle seat.

Squeeze the rotation handle and swivel the seat to face you in side view.

Squeeze the release handle located on the front of the car seat while lifting the car seat off the base and flipping it over to the opposite side.

Loosen Tether Strap

Lift the tether adjuster to loosen the strap. Or, if your seat has an adjuster with a button, then squeeze the adjuster button and pull the strap to loosen as shown.



3

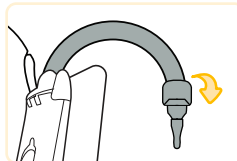

Lay Top Tether Strap Over the Vehicle Seat

You will be installing the top tether strap in steps 7–8.

Review the vehicle owner's manual for the tether anchor locations.

4

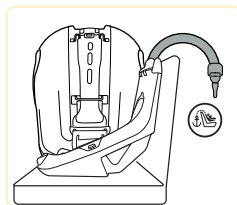

i

Vehicle Belt Lock Off **MUST BE Closed** BEFORE Routing Lower Anchor Belt

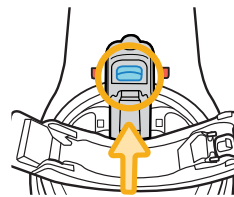

When using the passenger or driver side locations, the car seat **MUST** be touching the back of the vehicle seat in front of it, or be as close as possible.

5

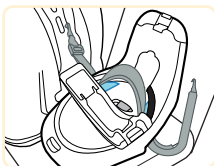

Weave Lower Anchor Belt In and Out of Belt Path

Then attach lower anchor hooks to the vehicle's lower anchor.

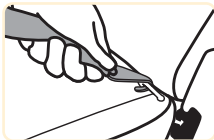

6

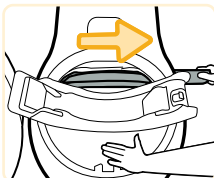

Tighten Belt & Gently Remove Slack

Place your hand in the base and firmly push the base down and back toward the vehicle seat.

Pull the belt parallel (in line) with the belt path as shown.

Tension indicators will begin to turn **green**.

Both indicators will turn completely green when the LATCH is properly installed.

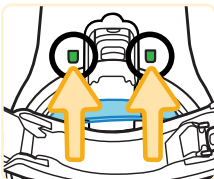

i

If the base moves more than 1 in. (2.5 cm) side to side at the belt path, you can try:

- Pulling the belt tighter; **OR**
- Reinstalling the base; **OR**
- Changing to a different seating location; **OR**
- Switching to a different install method (vehicle belt).

7

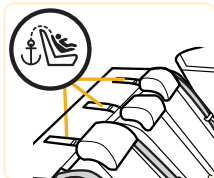

Locate Vehicle Tether Anchors

Locations vary by vehicle. Review your vehicle owner's manual for top tether anchor locations and how to route the belt when there are vehicle headrests.

8

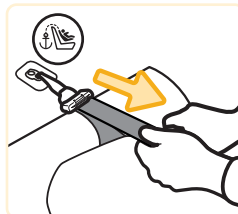

Attach and Tighten Top Tether Strap

FINISHED!

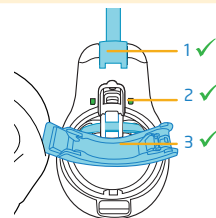

1. Tether Installed? If it is not installed, see steps 7–8.

2. Belt Tension Indicators Completely Green?

If they are not green, see steps 5–6.

3. Car Seat Cradle Side-Facing As Shown? If it is not side-facing, squeeze the rotation handle and it move into side-facing position.

Rear-Facing Child Fit: See pages 19–23.

Forward-Facing Child Fit: See pages 26–30.

Booster Seat Use in Vehicle: See pages 42–45.

When using the passenger or driver side locations, the car seat **MUST** be touching the back of the vehicle seat in front of it, or be as close as possible.

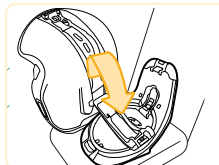

Flip Car Seat Over

Push down on the front of the car seat to lock into place.

⚠️ WARNING

Failure to follow these instructions may result in serious injury or death to your child. Serious injury can include paralysis and/or permanent brain injury.

Be certain to measure your child's weight and height (do not guess) before choosing this car seat's mode.

Your child's height, weight, and age determine how the car seat should be placed in the vehicle.

Children vary widely in body size, shape, and temperament—**please consult your doctor before switching between any modes within the limits and fit requirements of the car seat.**

Infants and Toddlers

Children must ride rear-facing and remain rear-facing until they reach the maximum weight or height limits for rear-facing mode. Rear-facing child restraints installed behind another vehicle seat must be installed touching the back of the vehicle seat in front of it, or be as close as possible.

Toddlers and Preschoolers

Children can only use a forward-facing car seat once they outgrow rear-facing weight or height limits. Once they are forward-facing, children must use their child restraint in forward-facing mode with a harness until they reach the maximum weight or height limits for forward-facing harness mode.

School-Aged Children

Children can only use a belt-positioning booster car seat once they outgrow forward-facing harness weight or height limits. Children must use the belt-positioning booster mode until the vehicle's lap and shoulder seat belt fit them properly without the belt-positioning booster.

Rear-Facing Mode

5–40 lb (2.3–18 kg) and
19–40 in. (48–101.6 cm)

In this car seat, your child **MUST** ride **Rear-Facing** and remain in **Rear-Facing** mode until they outgrow any one of the above.

Rear-Facing Mode PAGE 17
Rear-Facing Child Fit PAGE 19



Forward-Facing Mode

30–65 lb (13.7–29.5 kg) and
34.4–49 in. (87.1–125 cm)

In this car seat, your child **MUST** remain in harnessed **Forward-Facing** mode until they outgrow any one of the above.

Forward-Facing Mode PAGE 24
Forward-Facing Child Fit PAGE 26



Booster Seat Mode

40–100 lb (18.1–45.4 kg) and
43.4–52 in. (110.1–132.1 cm)

In this car seat, your child can use the **Booster Seat** mode until they fit the vehicle's lap and shoulder seat belt properly without a **Booster Seat** OR outgrow any one of the above.

Booster Seat Mode PAGE 35
Storing Harness System PAGE 37
Booster Seat Use in Vehicle PAGE 42



Rotating and Reclining Car Seat on Base

You must squeeze the **Rotation Handle** on the front of the base to move the seat out of Rear-Facing or Forward-Facing modes.



Rotation Handle

Rotation Lock Indicator will show the **locked** symbol when car seat is locked in place.

⚠ WARNING

SIDE-FACING Position ONLY for use when:

- Placing child into car seat.
- Removing child from car seat.

Side-Facing Position (Towards Parent)



To rotate the car seat from Side-Facing for all modes, firmly rotate the seat towards the back or front of the base.

Rear-Facing Mode

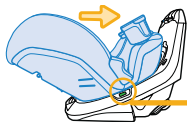

The **Rotation Lock Indicator** will show the **locked** symbol when car seat is locked in place.

Reclining Car Seat

There are 5 Recline positions in **Rear-Facing Mode**.

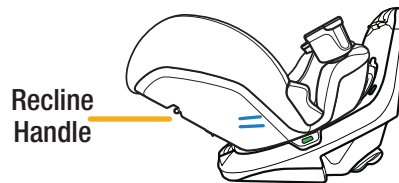

Recline Handle

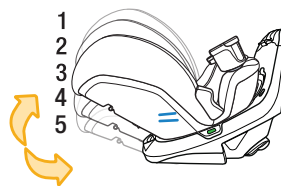

For children **5–30 lb (2.3–13.6 kg) and 19–34.3 in. (48–87 cm)**, the bottom level line on the car seat **MUST** be parallel with the ground.

For children **30–40 lb (13.7–18 kg) and 34.4–40 in. (87.1–101.6 cm)** **AND can sit up unassisted**, the top level line on the car seat **MUST** be parallel with the ground.

Choose the recline position that ensures the appropriate level line for your child's weight and height is parallel with the ground.

To Recline: Squeeze the recline handle and push the top of the car seat back.

For More Upright: Squeeze the recline handle and pull the top of the car seat forward.

Forward-Facing and Booster Seat Mode



Rotation Handle

The car seat **MUST be fully reclined in Position 5 BEFORE** rotating it to Forward-Facing. **Rotation Lock Indicator** will show the **locked** symbol when car seat is locked in place.

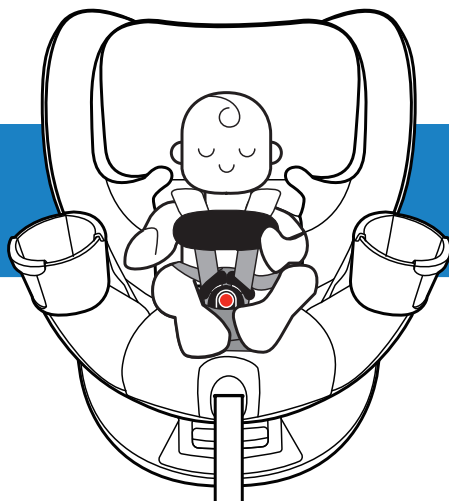

**5–40 lb (2.3–18 kg) and
19–40 in. (48–101.6 cm)**

Children under 1 year of age **MUST** ride **Rear-Facing**.

In this car seat, your child **MUST** ride **Rear-Facing** and remain in **Rear-Facing** mode until they outgrow any one of the following:

- **Weight Limit:** 40 lb (18 kg); **OR**
- **Height Limit:** 40 in. (101.6 cm); **OR**
- **Rear-Facing Child Fit** requirements, see pages 19–23.

Please see page 3–4 for accessory use.

⚠ WARNING



When top tether anchors are available, you **MUST ALWAYS** attach, adjust, and secure the tether (top anchorage) strap when installing the car seat in all modes.

NEVER install a rear-facing child restraint in the front seat of a vehicle equipped with an active frontal airbag.

DO NOT use the lower anchors of the child restraint anchorage system (LATCH system) to attach this child restraint when restraining a child weighing more than 30 lb (13.6 kg).

The vehicle belt **MUST** be used for installation if your child weighs more than 30 lb (13.6 kg).

DO NOT use the lower anchor belt along with the vehicle lap or lap/shoulder belt.

DO NOT fasten multiple lower anchor hooks on the same lower anchor bar in the vehicle.

Check the vehicle belt or the lower anchor belt before each use.

Use **ONLY** if the belt can be tightened properly and locked securely in place.

DO NOT leave child restraint in Side-Facing mode while vehicle is in motion.

Even when unoccupied, this child restraint **MUST** be firmly secured to the vehicle with the lower anchor belt or with the vehicle seat belt in Rear-Facing or Forward-Facing mode.

This child restraint **MUST ALWAYS** face the rear of the vehicle until the child has reached the maximum weight or height limit for the Rear-Facing mode.

DO NOT use this chest clip with children who have an implanted electronic medical device.

A magnet is used to help secure the chest clip locking mechanism together which may interfere with the proper function of an implanted electronic medical device.

Parents or caregivers who have an implanted electronic device should keep their device away from the chest clip and consult their doctor and medical device manufacturer for specific information before using this chest clip.



⚠️ WARNING

The car seat is attached to the base via cable wires and should **NOT** be removed.

The harness holders on the sides of this child restraint contain a **MAGNET** which may interfere with any implanted medical electronic device.

1



Rotate Car Seat in Side-Facing Position on Base

Squeeze the rotation handle and swivel the seat to face you in side view.

2

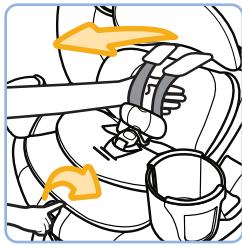

Fully Loosen Harness Straps

Push down on the harness release lever (through the opening in the pad) while pulling at or below the harness covers as shown.

3

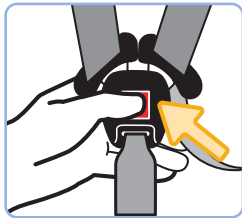

Undo Buckle

4

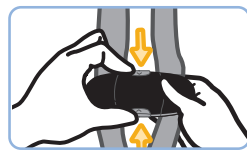

Undo Chest Clip

Hold the chest clip with both hands and press in on the top and bottom buttons with your index finger and thumb as shown.

While holding the buttons in, pull the right (top) half of the clip apart from the left (bottom) half to release the magnet and separate the chest clip.

5

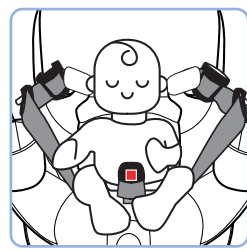

Place Child in Car Seat

You may use the magnetic harness holders on the sides of the seat to place the harness straps out of the way.

Your child's bottom and back should be flat against the car seat.

6

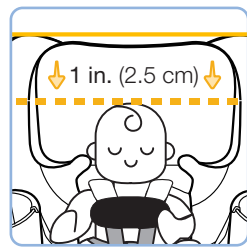

Check Headrest Position

The top of your child's head **MUST be at least 1 in. (2.5 cm) below** the top of the car seat's headrest.



7

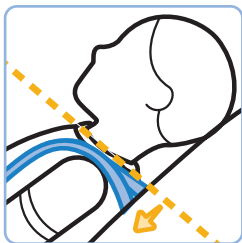

Check Harness Strap Position

The harness strap **MUST** be placed **at the shoulder** when possible, or slightly below; never above.

8

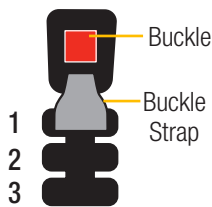

Check Buckle Position

- Use the slot closest to your child.
- The buckle strap **should not be underneath or behind** your child.

The buckle can be used in **any** buckle slot.

9

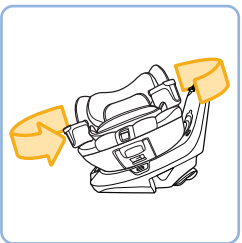

Rotate Car Seat Towards Rear-Facing Position

Rotation Lock Indicator will show the **locked** symbol when car seat is locked in place.

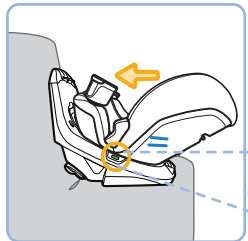

10

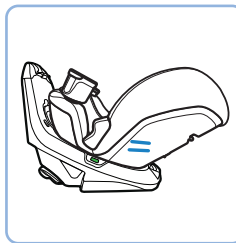

Check Rear-Facing Level Lines

For children 5–30 lb (2.3–13.6 kg) and 19–34.3 in. (48–87 cm), the bottom level line on the car seat **MUST** be parallel with the ground. For children 30–40 lb (13.7–18 kg) and 34.4–40 in.

(87.1–101.6 cm) **AND can sit up unassisted**, the top level line on the car seat **MUST** be parallel with the ground.

For more information, see Rotating and Reclining Car Seat on Base on pages 15–16.

i

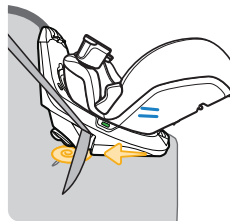

Only if necessary, you may place a tightly rolled towel(s) or foam pool noodle(s) under the front of the car seat base to help make the appropriate **Rear-Facing Level Line** for your child parallel with the ground.

Check often to make sure padding is still in place and the belt is tight.

i

To secure child in car seat, see pages 31–34.

To change the harness strap height, see page 46.

To change the buckle position, see pages 47–49.

To learn how to check harness tightness, see pages 31–34.

FINISHED!

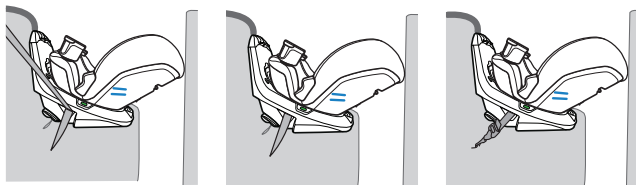

Lap/Shoulder
Belt + Tether



Lap Belt
+ Tether



LATCH: Lower
Anchor Belt + Tether

DO NOT install by this method for a child weighing more than 30 lb (13.6 kg).

- ✓ **Headrest Position:** Is your child's headrest in the correct position? See step 6.
- ✓ **Harness Strap Position:** Is your child's harness strap in the correct position? See step 7.
- ✓ **Buckle Position:** Is your child's buckle in the correct position? See step 8.
- ✓ **Vehicle Belt Install:** See page 5.
- ✓ **LATCH: Lower Anchor Belt Install:** See page 9.

When using the passenger or driver side locations, the car seat **MUST** be touching the back of the vehicle seat in front of it, or be as close as possible.

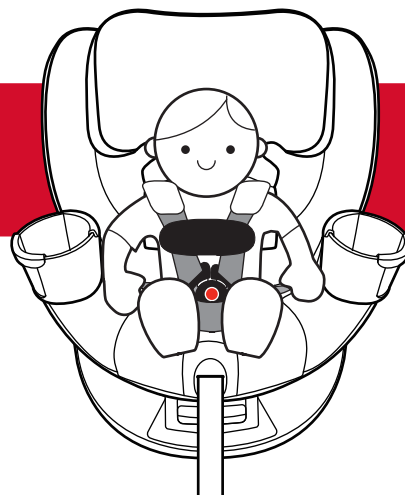

30–65 lb (13.7–29.5 kg) and
34.4–49 in. (87.1–125 cm)

In this car seat, your child **MUST** remain in harnessed **Forward-Facing** until they outgrow any one of the following:

- **Weight Limit:** 65 lb (29.5 kg); OR
- **Height Limit:** 49 in. (125 cm); OR
- **Forward-Facing Child Fit** requirements, see pages 26–30.

Please see page 3–4 for accessory use.

⚠️ WARNING

When top tether anchors are available, you **MUST ALWAYS** attach, adjust, and secure the tether (top anchorage) strap when installing the car seat in all modes.

DO NOT use the lower anchors of the child restraint anchorage system (LATCH system) to attach this child restraint when restraining a child weighing more than 35 lb (15.9 kg).

The vehicle belt **MUST** be used for installation if your child weighs more than 35 lb (15.9 kg).

When anchors are available, you **MUST ALWAYS** attach, adjust, and secure the tether (top anchorage) strap when installing the car seat in the Forward-Facing mode with internal harness.

DO NOT use the lower anchor belt along with the vehicle lap or lap/shoulder belt.

Check the vehicle belt or the lower anchor belt before each use. Use **ONLY** if the belt can be tightened properly and locked securely in place.

DO NOT fasten multiple lower anchor hooks on the same lower anchor bar in the vehicle.

DO NOT leave child restraint in Side-Facing mode while vehicle is in motion.

Even when unoccupied, this child restraint **MUST** be firmly secured to the vehicle with the lower anchor belt or with the vehicle seat belt in Rear-Facing or Forward-Facing mode.

Before using this seat in forward-facing mode, your child must have outgrown the seat in rear-facing mode.

DO NOT use this chest clip with children who have an implanted electronic medical device.

A magnet is used to help secure the chest clip locking mechanism together which may interfere with the proper function of an implanted electronic medical device.

**IMPLANTED
ELECTRONIC
MEDICAL
DEVICES**

Parents or caregivers who have an implanted electronic device should keep their device away from the chest clip and consult their doctor and medical device manufacturer for specific information before using this chest clip.

⚠️ WARNING

The car seat is attached to the base via cable wires and should **NOT** be removed.

The harness holders on the sides of this child restraint contain a **MAGNET** which may interfere with any implanted medical electronic device.

1



Rotate Car Seat in Side-Facing Position on Base

Squeeze the rotation handle and swivel the seat to face you in side view.

2

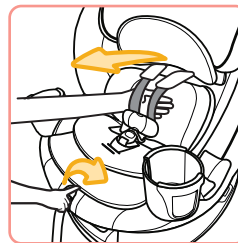

Fully Loosen Harness Straps

Push down on the harness release lever (through the opening in the pad) while pulling at or below the harness covers as shown.

3

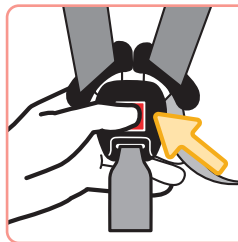

Undo Buckle

4

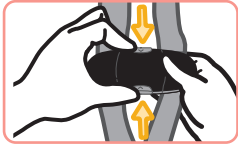

Undo Chest Clip

Hold the chest clip with both hands and press in on the top and bottom buttons with your index finger and thumb as shown.

While holding the buttons in, pull the right (top) half of the clip apart from the left (bottom) half to release the magnet and separate the chest clip.

5

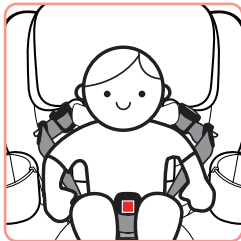

Place Child in Car Seat

You may use the magnetic harness holders on the sides of the seat to place the harness straps out of the way.

Your child's bottom and back should be flat against the car seat.

6

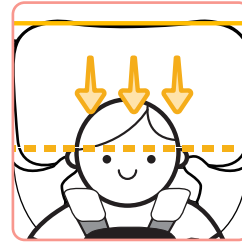

Headrest Position

The top of your child's ears **MUST be below** the top of the car seat's headrest.

7

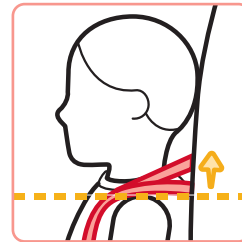

Harness Strap Position

The harness strap **MUST** be placed **at the shoulder** when possible, or slightly above; never below.

8

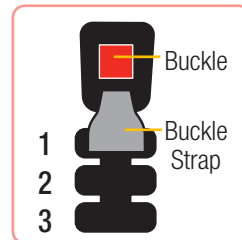

Buckle Position

- Use the slot closest to your child.
- The buckle strap **should not be underneath or behind** your child.

The buckle can be used in **any** buckle slot.

continued on next page

9

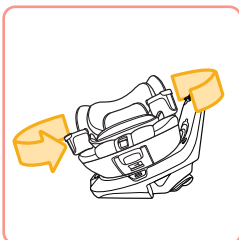

Rotate Car Seat Towards Forward-Facing Position

The car seat **MUST be fully reclined** to rotate it Forward-Facing.

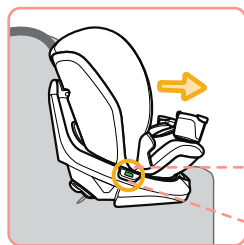

The rotation Lock Indicator will show the **locked** symbol when the car seat is locked in place.



i

To secure child in car seat, see pages 31–34.

To change the harness strap height, see page 46.

To change the buckle position, see pages 47–49.

To learn how to check harness tightness, see pages 31–34.

FINISHED!

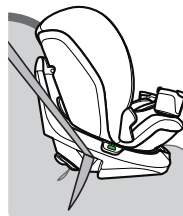

Lap/Shoulder Belt + Tether

for a child up to 65 lb (29.5 kg)



Lap Belt + Tether

for a child up to 65 lb (29.5 kg)

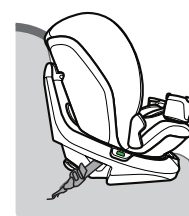

LATCH: Lower Anchor Belt + Tether

Do not install by this method for a child weighing more than 35 lb (15.9 kg)

- ☑ **Headrest Position:** Is your child's head in the correct position? See step 6.
- ☑ **Harness Strap Position:** Is your child's harness strap in the correct position? See step 7.
- ☑ **Buckle Position:** Is your child's buckle in the correct position? See step 8.
- ☑ **Vehicle Belt Install:** See page 5.
- ☑ **LATCH: Lower Anchor Install:** See Page 9.

⚠️ WARNING

**IMPLANTED
ELECTRONIC
MEDICAL
DEVICES**

DO NOT use this chest clip with children who have an implanted electronic medical device.

A magnet is used to help secure the chest clip locking mechanism together which may interfere with the proper function of an implanted electronic medical device.

Parents or caregivers who have an implanted electronic device should keep their device away from the chest clip and consult their doctor and medical device manufacturer for specific information before using this chest clip.

If a parent/caregiver or child has an implanted electronic medical device, please contact Dorel (see back cover) for a replacement (non-magnetic) chest clip free of charge.

1

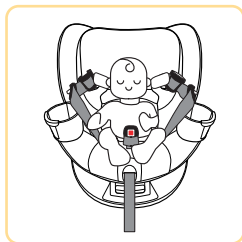

Place Child in Car Seat

Position harness straps over your child's shoulders and upper thighs. Push buckle tongues into buckles until you hear them "click".

Your child's bottom and back should be flat against the car seat.

2

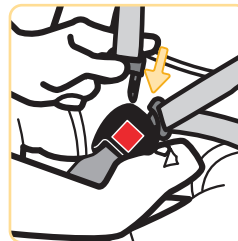

Buckle Harness

Pull the harness straps up to make sure the buckle is locked.

3



Fasten Chest Clip

Lay the right (top) half of the chest clip over the left (bottom) half and it will automatically snap together and lock.

Pull gently on each half of the chest clip together to make sure it is locked.

4

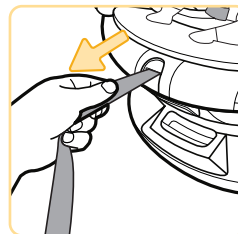

Tighten Harness

Pull the harness adjustment strap straight out to snugly tighten the harness.

FINISHED!



Your child is now secured in the car seat. Check your child's fit often and make any needed adjustments to the car seat as they grow.

- To Remove Child from Car Seat:** Clean with warm water and/ or remove the object with tweezers. If you cannot get the harness to adjust and remain tight with the buckle securely locked, **DO NOT** use this car seat.
1. Loosen Harness Strap
 2. Unbuckle Harness
 3. Release Chest Clip
 4. Remove Child

Troubleshooting

1. **If the buckle or harness release lever sticks: DO NOT lubricate.** Check for dropped food, sticky spilled drinks, dirt, leaves, etc.
2. **If your harness twists:** Straighten the harness each time you put your child in the car seat. Lock the buckle and tighten the harness so it will be ready for next use.

⚠️ WARNING

Failure to fasten and tighten the harness system correctly may allow the child to be ejected from the child restraint in a crash or sudden stop causing serious injury or death. Serious injury can include paralysis and/or permanent brain injury.



DO NOT mistake comfort for safety. The harness system **MUST** be snugly adjusted.

DO NOT put snowsuits or bulky garments on your child when placing them in the child restraint.

Bulky clothing can prevent the harness straps from being tightened properly.

Position Chest Clip

Pull the harness covers down on the child.

Place the chest clip on the lower part on the harness cover so that the harness covers are between your child and the chest clip.

Position it at mid-chest (even with armpits) and away from your child's neck.

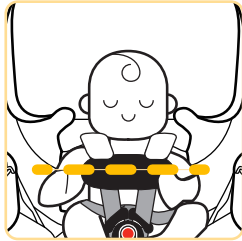

Check Harness Tightness

Remove the top part of the harness covers.

Try to pinch the harness at the shoulders vertically between index finger and thumb as shown. Make sure you are pinching the harness strap above the bottom part of the harness cover and not the harness cover itself.

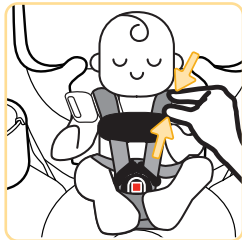

If your fingers slip off, the harness is tight enough.

If you can pinch the harness strap, tighten more.

Fasten the harness covers.

i

A snug strap should not allow any slack.

It lies in a relatively straight line without sagging.

It does not press on the child's flesh or push the child's body into an unnatural position.

Rotate Car Seat towards the desired position

Rotation Lock Indicator will show the **locked** symbol when car seat is locked in place.



7

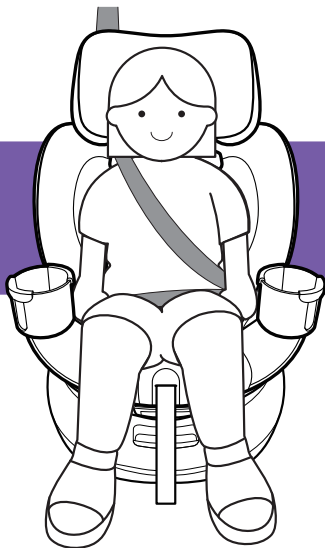

**40–100 lb (18.1–45.4 kg) and
43.4–52 in. (110.1–132.1 cm)**

In this car seat, your child can use the **Booster Seat** mode until they fit the vehicle's lap and shoulder seat belt properly without a **Booster Seat** OR outgrow any one of the following:

- **Weight Limit:** 100 lb (45.4 kg); OR
- **Height Limit:** 52 in. (132.1 cm); OR
- **Booster Seat Use in Vehicle** requirements, see page 42–45.

You **MUST** store the harness system and remove the accessories, except the cup holder(s), when using the **Booster Seat Mode**.

To remove accessories, see pages 3–4.

Storing Harness System: Page 37

Booster Seat Use in Vehicle: Page 42

⚠️ WARNING

When top tether anchors are available, you **MUST ALWAYS** attach, adjust, and secure the tether (top anchorage) strap when installing the car seat in all modes.

DO NOT use the harness system when using as a booster seat.



Warning! Use **ONLY** the vehicle's lap and shoulder belt system when restraining the child in this booster seat.

DO NOT use only the lap belt when using this seat as a booster seat.

The shoulder belt **MUST** always be adjusted snugly across the child's chest.

NEVER place shoulder belt under the child's arms or behind their back.

DO NOT use the lower anchor belt along with the vehicle lap or lap/shoulder belt.

DO NOT leave child restraint in Side-Facing mode while vehicle is in motion.

Even when unoccupied, this child restraint **MUST** be firmly secured to the vehicle with the vehicle seat belt or Forward-Facing mode.

DO NOT use this booster seat if the tops of your child's ears are above the top of the booster seat's headrest.



This restraint is **NOT** certified for aircraft use when used as a booster seat because aircraft seats do not have shoulder belts.

1

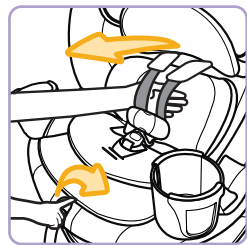

Fully Loosen Harness Straps

Push down on the harness release lever (through the opening in the pad) while pulling at or below the harness covers as shown.

2

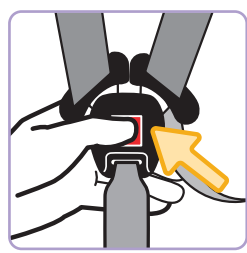

Undo Buckle

3

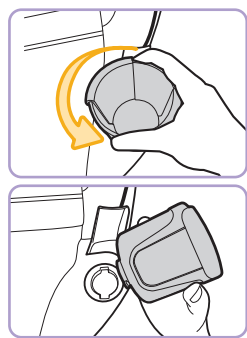

Remove Cup Holders

Twist the cup holder counterclockwise. Pull it out of the slot in the car seat.

4

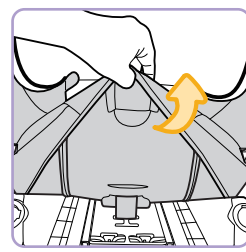

Lift Seat Pad from Front of Car Seat

5

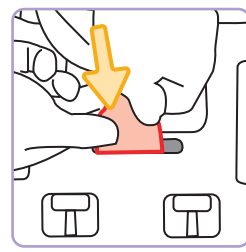

Push Buckle Strap Down

Feed the entire buckle strap (front and back straps) through the slot into the seat.

6

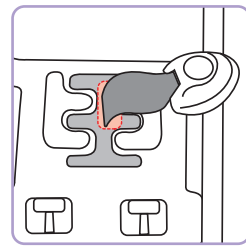

Rotate Buckle Strap

Holding both the front and back straps, rotate the buckle into the center channel so that it is perpendicular to the slots.

7

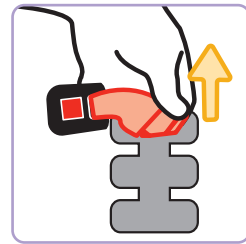

Pull Buckle & Buckle Cover Out of Car Seat

Store the buckle and buckle cover in a safe place for future use.



8

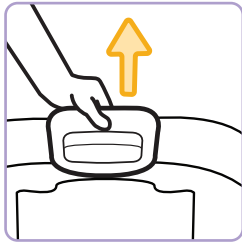

Adjust Headrest to Highest Position

9

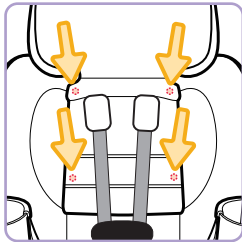

Undo Fasteners on Headrest Pad & Seat Pad

10

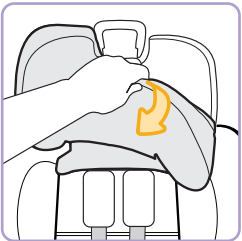

Pull Headrest Pad Off Top of Headrest

11

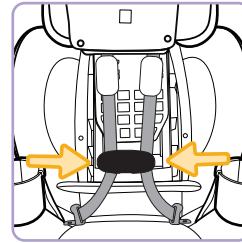

Place Chest Clip, Harness Straps, & Buckle Tongues at the Bottom of headrest

12

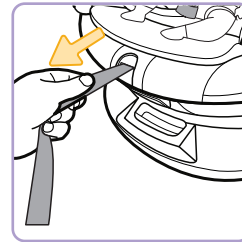

Tighten Harness
Remove any slack from the harness system.

13

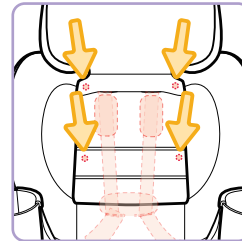

Wrap Headrest Pad Around Top of Headrest

Attach the fasteners on the headrest pad and the seat pad.

14

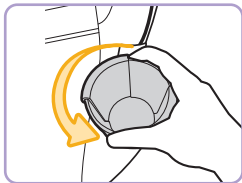

Replace Cupholders

Put it in of the slot in the car seat.

Twist the cup holder clockwise.

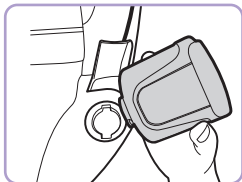

FINISHED!

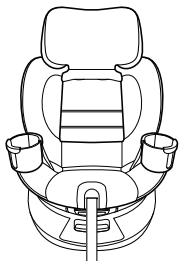

The car seat has been converted to the **Booster Seat Mode**.

See next page for **Booster Seat Use in Vehicle**.

Booster Seat Use in Vehicle

! WARNING

The car seat is attached to the base via cable wires and should **NOT** be removed

1

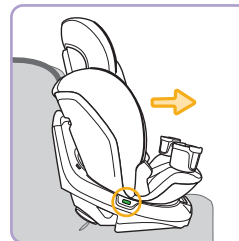

Rotate Booster Seat in Forward-Facing Position on Base

Rotation Lock Indicator will show the **locked** symbol when car seat is locked in place.

2

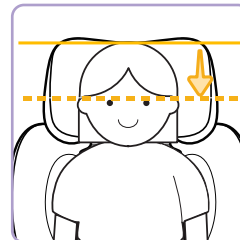

Have Child Sit in Booster Seat

The top of your child's ears should never be above the top of the booster seat's headrest.

Position Lap Belt on Child

Route **ONLY** the lap belt portion of the vehicle belt through the **Booster Seat Belt Path** as shown. The lap belt should lay snugly across your child's hips; **not on their stomach.**

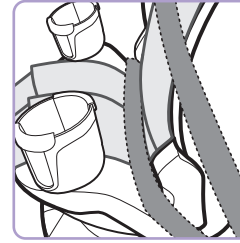

Buckle Vehicle Belt

Pull the shoulder belt up to tighten.

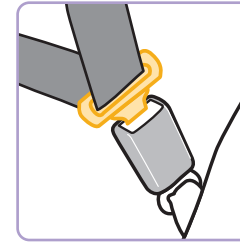

Position Shoulder Belt on Child

Thread the shoulder belt through the belt-positioning guide in the headrest.

Pull the shoulder belt up to tighten so that it lies snugly across the center of your child's shoulder and across their chest.

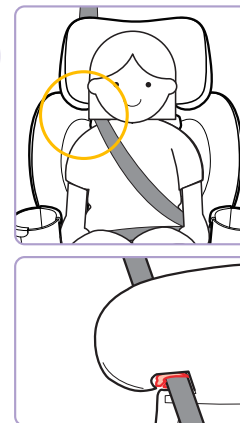

5

6

7

i

If your vehicle has a headrest that interferes with a flush car seat fit, check your vehicle owner's manual to see if it can be removed, adjusted, or if there are other possible seating locations for you to install.

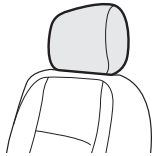

Car Position

DO NOT use the booster seat if your child's head is less than **5 in. (12.7 cm)** below the roof of the car. Consult your vehicle manual for proper seat belt usage.

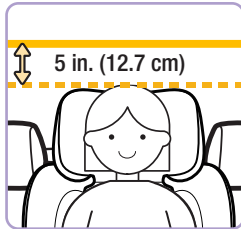

3

4

Shoulder Belt Position

The shoulder belt should lay snugly across the center of your child's shoulder and across their chest.



FINISHED!

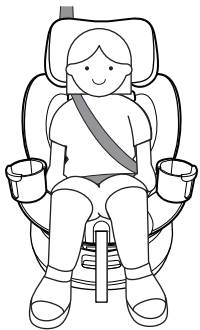

Check periodically to make sure your child has not moved out of position and loosened the shoulder belt.

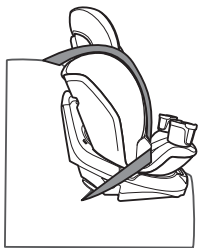

Keep the booster seat securely belted through the belt-positioning guide in Forward-Facing position even when unoccupied.

1

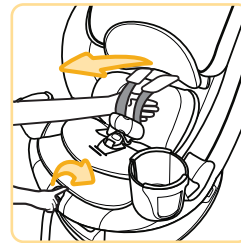

**Fully Loosen
Harness Straps**

Push down on the harness release lever (through the opening in the pad) while pulling at or below the harness covers as shown.

2

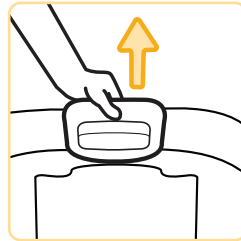

**Adjust Headrest/
Harness Height**

1. Squeeze the adjustment handle lever up.
2. Move the headrest up or down to the proper height for your child.

3. Release the handle to lock the headrest in place.
4. Make sure it is locked securely.



For Rear-Facing Child Fit, see page 19–23.

For Forward-Facing Child Fit, see page 26–30.

To learn how to check harness tightness, see pages 31–34.

Check the harness straps often for any wear or damage.

⚠️ WARNING

Failure to place buckle's metal retainer completely through pad and child restraint can result in serious injury or death. Serious injury can include paralysis and/or permanent brain injury.

1



Undo Buckle

2

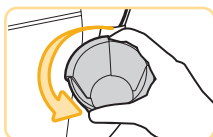

Remove Cup Holders

Twist the cup holder counterclockwise.



Pull it out of the slot in the car seat.

3

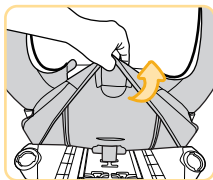

Lift up Seat Pad

4

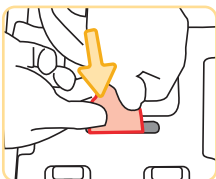

Push Buckle Strap Down

Feed the entire buckle strap (front and back straps) through the slot into the seat.

Push Buckle Strap into New Slot

5a

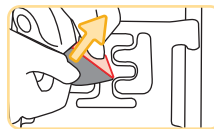

To move the buckle strap backward: Move the **back** buckle strap into the new slot by pulling it into the center channel, and then pushing it into both the left and right sides of the slot. Once the back buckle strap is in position, repeat with the front buckle strap.

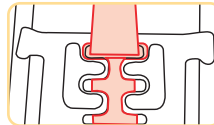

OR

5b

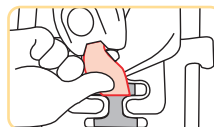

To move the buckle strap forward: Move the **front** buckle strap into the new slot by pulling it into the center channel, and then pushing it into both the left and right sides of the slot. Once the front buckle strap is in position, repeat with the back buckle strap.

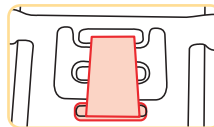

6

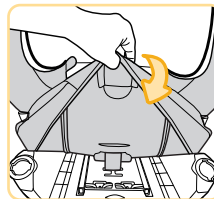

Replace Seat Pad Around Bottom & Sides of Seat

7

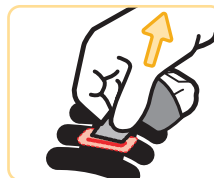

Replace Buckle Cover and Check Buckle

Pull the buckle up to make sure it is secured.

The buckle **MUST NOT** pull out.

8

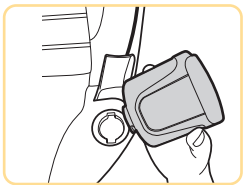

Replace Cup Holders

Put the cup holder in the slot in the car seat.
Twist the cup holder clockwise

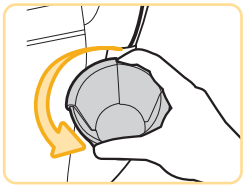

For Rear-Facing Child Fit, see page 19–23.
For Forward-Facing Child Fit, see page 26–30.
To learn how to check harness tightness, see pages 31–34.

Removing Seat Pad Set



You do not need to remove the harness system to remove the pad from the car seat.
DO NOT fully pull the harness strap out of the car seat. Leave it threaded in the hip harness slots. If removed, you will not be able to rethread it.
To remove accessories, see pages 3–4.

1

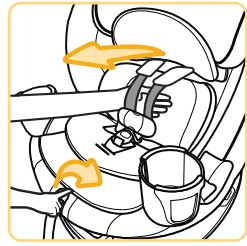

Fully Loosen Harness Straps

Push down on the harness release lever (through the opening in the pad) while pulling at or below the harness straps as shown.

2

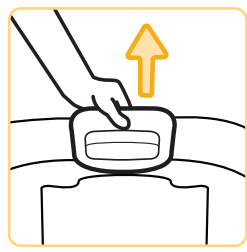

Adjust Headrest to Highest Position

3



Gently Pull Headrest Pad Off Top of Headrest

4

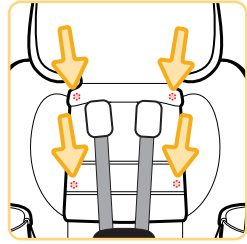

Undo Fasteners on Seat Pad



5

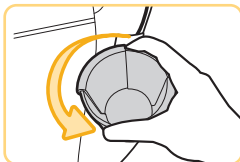

Remove the Cup Holders

Twist the cup holder counterclockwise.

Pull it out of the slot in the car seat.

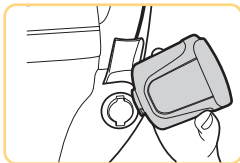

6

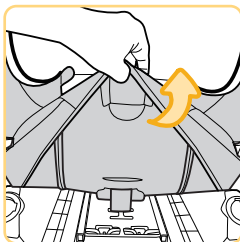

Pull Seat Pad Off Sides & Bottom of Car Seat

7

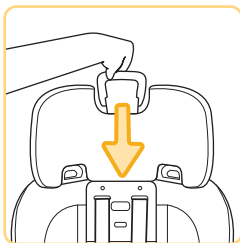

Lower Headrest to Middle of Car Seat

8

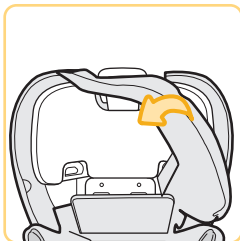

Pull Seat Pad Around Headrest & Off of Car Seat

Cleaning Pad & Top Harness Covers & Accessories

ONLY the top parts of the harness covers and the seat pad can be machine washed. You **MUST** turn car seat pad inside-out before machine washing. Machine wash separately with cold water on a gentle cycle. **DO NOT** use bleach. Tumble dry separately for 10–12 minutes on low heat. Remove immediately.

Toddler Pad & Body Pillow: Place inside pillow case. **DO NOT** use bleach. Tumble dry separately for 10–12 minutes on low heat. Remove immediately.

Cleaning Harness Strap & Bottom Harness Cover

Check the harness straps often for any wear or damage.

Spot clean using warm sudsy water and damp cloth. Spilled food and liquids on the car seat may result in mold or bacterial growth over time. These spills could also attract insects or rodents.

Cleaning Buckle & Car Seat

Spot clean using warm sudsy water and damp cloth. **DO NOT** submerge into water.

Installing Seat Pad Set

1. Lower headrest to middle of car seat.
2. Pull seat pad around headrest.
3. Pull seat pad around sides and front of car seat.
4. Adjust headrest to highest position.
5. Pull headrest pad onto headrest.
6. Attach all pad fasteners.
7. Replace cup holders.

⚠️ WARNING

DO NOT use the child restraint without the seat pad or with damaged harness straps. Failure to do this can result in serious injury. Serious injury may include paralysis and/or permanent brain injury.

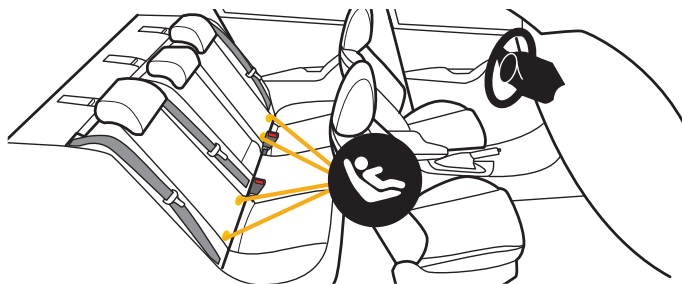

Your vehicle's features may be considerably different than those pictured here.

The lower anchors of **LATCH** (Lower Anchors and Tethers for **CH**ildren) is a universal system for installing car seats without using vehicle seat belts. The LATCH: lower anchor belt can **ONLY** be used in vehicles that have the lower anchor bars installed in designated seating positions. Most vehicles manufactured after September 2002 are equipped with LATCH: lower anchor bars. Check your vehicle owner's manual to see which seating positions may be equipped with LATCH: lower anchor bars.

Lower Anchor Belt Parts

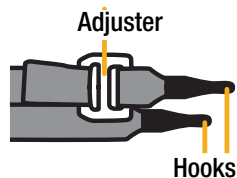

Lower Anchor Belt Storage Location

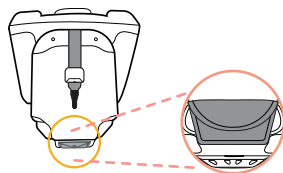

To Remove Lower Anchor Belt from Storage Location in Base

Open the pouch located on the base and pull the LATCH: Lower Anchor Belt out.

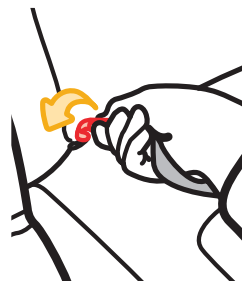

To Remove Lower Anchor Belt from Vehicle's Lower Anchor Bars

1. Remove the tension from the belt by pushing down on the side of the base with the adjuster.
2. Press the adjuster's button to loosen the belt.
3. Squeeze the spring lever on the hooks, push the hooks back into the vehicle seat, and rotate the hooks to the side.
4. Pull the hooks off of the vehicle's lower anchor bars.

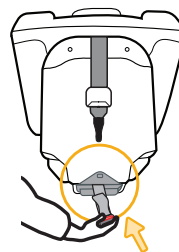

To Store Lower Anchor Belt

The lower anchor belt **MUST** be properly stored in its storage location when:

- using the vehicle belts to install the base; **OR**
- the base is not installed in a vehicle.

Gather the lower anchor belt and place it into the storage location as shown.

⚠ WARNING

DO NOT use both the lower anchor belt and vehicle belt at the same time.

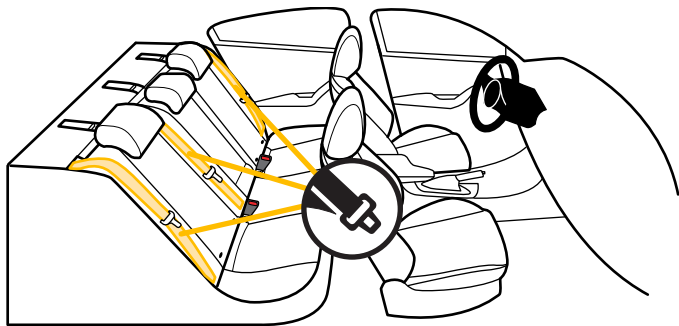

Your vehicle's features may be considerably different than those pictured here.

If LATCH: lower anchors are not an option or if your child weighs more than **30 lb (13.6 kg)**, in **Rear-Facing Mode** or **35 lb (15.9 kg)** in **Forward-Facing Mode** you **MUST** use the vehicle seat belt system to install the car seat.

Not all vehicle belts and seating positions will work with car seats. Please go through the following steps to understand how to lock a car seat in Rear-Facing Mode or Forward-Facing Mode with a vehicle belt.

1

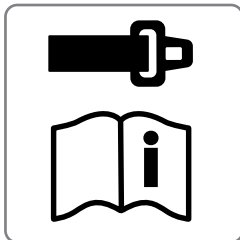

You **MUST** Review Your Vehicle Owner's Manual

Your vehicle owner's manual will let you know which vehicle belts and seating positions car seats can be installed in.

2



Check How This Car Seat Will Be Locked Into Place

The vehicle belt **MUST NOT** loosen after tightening.

This means there needs to be a way to lock the vehicle belt.

The ways this can be done are:

- By using the seat belt's retractor (see step 4); **OR**
- By using the seat belt's latch plate (see step 5).

3

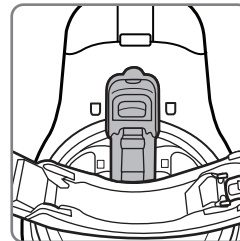

Lock Off

The vehicle belt retractor **MUST** be locked after closing the lock off.

Please go to the vehicle belt with base installation section of the manual to see how to properly use this feature.

Installing Base with Vehicle Belt: **Page 5**

4

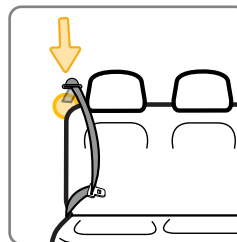

Check Retractor

Retractors pull seat belts into stored positions and lock the belt to hold passengers in place.

See the next page for some common types of vehicle belt retractors that will work with this car seat.

Types of Retractors

Switchable Retractor

(most vehicles have this type)

This retractor can be switched to a locking mode.

You **MUST have the retractor in the locking mode** to use the seat belt with this car seat.

Switching to locking mode: Slowly pull the shoulder belt all the way out, then let it go back in **1–2 in.** (2.5–5 cm).

As it goes back in, you will most likely hear a ratcheting sound.

Gently pull the belt to see if it has locked. You will not be able to pull any more belt out if the lock has engaged.

Automatic Locking Retractor

This retractor always locks.

It will automatically lock after slowly pulling the seat belt out at least halfway and letting the belt go back into the retractor **1–2 in.** (2.5–5 cm).

Emergency Locking Retractor

See Step 5
Check Latch Plates

If the retractor does not lock, it is most likely an Emergency Locking Retractor. These retractors only lock during a sudden stop or collision.

You will need to determine if your seat belt's latch plate can lock the belt. See step 5, Check Latch Plates.

5



Locking
Latch
Plate



Sliding
Latch
Plate

Check Latch Plates

Latch plates are the part of the vehicle belt that goes into the buckle.

To see if the latch plate locks:

1. Buckle vehicle belt.
2. Slowly pull up on the lap portion of the vehicle belt.

If the vehicle belt does not slide through the latch plate, it's locked.

If the vehicle belt slides through the latch plate, it is a **sliding latch plate**.

Sliding latch plates easily slip between the lap and shoulder portions of the belt.

i

**Never Use the Following With
This Car Seat:**

- Emergency Locking Retractor Lap Only Belt
- Inflatable Seat Belts

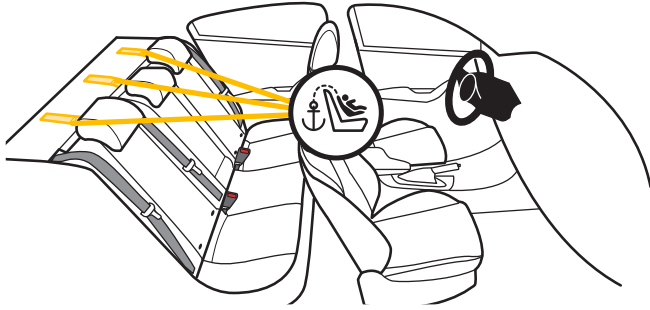

Your vehicle's features may be considerably different than those pictured here.

When anchors are available, you **MUST always attach, adjust, and secure the tether (top anchorage) strap** when installing the car seat. Tethers improve the installation and stability of car seats and reduce the risk of injury. Attach the tether hook to the tether anchor designated by your vehicle manufacturer for that seating position. Check your vehicle owner's manual for more information. If the seating position does not have a tether anchor, use a different seating position or see your dealer or a qualified mechanic and have one installed.

⚠️ WARNING

Using this child restraint without the tether strap anchored as required by the manufacturer would be a misuse of the child restraint and, in a sudden stop or crash, could result in serious injury or death. Serious injury can include paralysis and/or permanent brain injury.

DO NOT fasten multiple tether hooks on the same tether anchor in the vehicle.

⚠️ WARNING

NEVER take your child out of the child restraint while the vehicle is moving.

NEVER leave your child unattended.

Placing your child in a hot child restraint may result in burns.

DO NOT use a child restraint with damaged or missing parts.

DO NOT use a child restraint with cut, frayed, or damaged harnesses.

DO NOT substitute parts or try to modify the child restraint in any way. **DO NOT** lubricate buckles and fasteners.

DO NOT use any child restraint accessory except those approved by Dorel Juvenile Group.

NEVER allow any child to play with this child restraint; it is not a toy.

DO NOT remove or cover up any of the warning labels or other labels on the child restraint.

This child restraint has been certified for use in passenger vehicles. **DO NOT** use in a boat, on a motorcycle or in a cargo van or bus where there are no seat belts or tether anchors.

Read all instructions for additional warnings.

⚠️ WARNING

NEVER place a child rear-facing in a seating position with an active frontal air bag.

Check the vehicle owner's manual for more information about air bag/child restraint use.



Use the child restraint only on vehicle seats that face forward.



DO NOT use on seats that face the sides or rear of the vehicle.

For vehicles without a back seat, refer to your vehicle owner's manual.



According to accident statistics, children are safer when properly restrained in the rear seating positions than in the front seating positions.

Rear seating positions are statistically safer, whether you have air bags, advanced air bags, or no air bags at all.

If you are not sure where to place the car seat in your vehicle:

- Consult your vehicle owner's manual; **OR**
- Contact Dorel Juvenile Group Consumer Care Department; **OR**
- Visit your local Child Passenger Inspection Station. Go to <https://www.nhtsa.gov/vehicle-safety/car-seats-and-booster-seats> to find your closest station.

To avoid your child being seriously burned, take the following precautions:

- Park in the shade or where the sun does not directly hit the car seat.
- Cover the car seat with a sheet or blanket when not in use.
- Check for hot seat and buckles before placing child in car seat.

To help protect your vehicle seat's upholstery from **damage**: You may use an accessory approved by Dorel Juvenile Group or a single layer towel underneath and behind car seat.

⚠️ WARNING

Check the vehicle belt or lower anchor belt before each use. Use only if the belt can be tightened properly and locked securely in place.

Even when unoccupied, this child restraint **MUST** be firmly secured to the vehicle with the lower anchor belt or with the vehicle seat belt.

Even when unoccupied, this booster seat **MUST** be firmly secured to the vehicle with the vehicle seat belt.

In a crash or sudden stop, an unsecured child restraint or booster seat could injure occupants.

DO NOT risk your child's safety.

To keep your child as safe as possible, Dorel Juvenile Group strongly recommends replacing the car seat even after a minor crash, even if it was not occupied at the time.

Replacement After a Minor Crash

The National Highway Traffic Safety Administration states that for a crash to be considered minor **ALL of the following MUST be true:**

- Vehicle able to drive away from the crash site; **AND**
- Vehicle door nearest the car seat was not damaged; **AND**
- No passengers were injured; **AND**
- Airbags did not deploy; **AND**
- There is no visible damage to the car seat.

If the crash your car seat was involved in meets **ALL** the criteria, you may not need to replace the car seat.

If one or more of these criteria are not true or if you are uncertain of any of your answers, replace the car seat immediately.

Replacement After a Moderate to Severe Crash

You **MUST** replace this car seat if it has been in a moderate to severe car crash.

This car seat is intended to protect a child in a single crash. During a crash, the car seat and all of its parts absorb crash energy which can deform or weaken it. Damage is not always visible. A damaged car seat **MUST** be replaced immediately.

Expiration

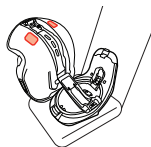

On the bottom of the car seat there is a date of manufacture label as shown.

DO NOT use this car seat more than 10 years after the date of manufacture.

0515079		Tear Off and Mail This Part or Register Online		4348-0081D	
Consumer: Just fill in your name, address and email. Please print (use dark ink).					
Your Name					
Your Street Address					
City				State	Zip Code
Email Address (optional)					
Model Number		Model Name		Manufacture Date	
AB123CDE		Brand Car Seat		2024/05/16	
			L#11 B265035		

Example of model number, manufacture date, and line code.

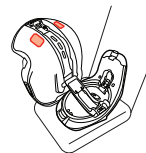

If you don't have the card or if your address changes, you will find the model number, manufacture date, and line code on the label located on the bottom of the car seat.

Please complete the postage-paid registration card that came with your child restraint, and send it to us.

Child restraints could be recalled for safety reasons.

You must register this restraint to be reached in a recall.

Send your name, address, e-mail address if available and the restraint's model number and manufacturing date to:

Dorel Juvenile Group

P.O. Box 2609
Columbus, IN 47202

or call 1-800-951-4113 or register online at www.djgusa.com/registration/carseat/us.

For recall information, call the U.S. Government's Vehicle Safety Hotline at 1-888-327-4236 (TTY: 1-800-424-9153), or go to www.NHTSA.gov.



This restraint is not certified for aircraft use.

This restraint is **NOT** certified for aircraft use when used as a booster seat because aircraft seats do not have shoulder belts.

Warranty

Dorel Juvenile Group, Inc. (DJG) warrants this product to the original retail purchaser as follows: This product is warranted against defective materials or workmanship for one year from the date of original purchase.

An original receipt is required to validate your warranty. DJG will, at its option, provide replacement parts or replace this product. DJG reserves the right to substitute if the part or model has been discontinued.

To make a claim under this warranty contact our Consumer Care Department by phone at 1-800-951-4113; or text us at 1-812-652-2525. Our hours of operation are from 8:00 a.m. to 6:00 p.m. ET Monday through Thursday and from 8:00 a.m. to 4:30 p.m. on Friday.

Proof of purchase is required and shipping charges are the responsibility of the consumer.

Warranty Limitations: This warranty does not include damages which arise from misuse or abuse of this product.

Limitation of Damages: The warranty and remedies as set forth are exclusive and in lieu of all others, oral or written, expressed or implied. In no event will DJG or the dealer selling this product be liable to you for any damages, including incidental or consequential damages, arising out of the use or inability to use this product.

Limitation of warranties and other warranty terms and state law rights: Any implied warranties, including implied warranties of the merchantability and fitness for a particular purpose, shall be limited to the duration and terms of the express written warranty. Some states do not allow limitations as to how long an implied warranty lasts or the exclusion or limitation of incidental or consequential damages, so the above limitations may not apply to you.

This warranty gives you specific legal rights, and you may have other rights, which vary from state to state. Neither DJG nor the dealer selling this product authorized any person to create for it any other warranty, obligation, or liability in connection with this product.

Please note: Our product warranty only applies when purchased from an authorized Maxi-Cosi retailer. The origin of products not purchased through these authorized retailers is unknown and could be counterfeit. We cannot support products from an unknown origin as we cannot verify the handling or condition of such merchandise. We maintain a strong network of authorized retailers to ensure you are purchasing safe and complete products. Fulfillment by a third party does not guarantee you are purchasing from one of these authorized retailers. Pricing which is inconsistent with the majority of retailers is a strong indication that the retailer is not authorized, as we have a consistent price offering across all authorized retailers. If you are unsure of the authorization status of a retailer you are considering purchasing from, or have purchased from, you can check www.maxicosi.com/us-en/shops.aspx; or call our Consumer Care Department at 1-800-951-4113; or text us at 1-812-652-2525.