

Contents

1	Instructions	4
1.1	General safety instructions	4
1.2	Manufacturer liability	5
1.3	Appliance purpose	5
1.4	Disposal	5
1.5	Identification plate	6
1.6	This user manual	6
1.7	How to read the user manual	6
2	Description	7
2.1	General Description	7
2.2	Control panel	8
2.3	Other parts	9
2.4	Available accessories	9
2.5	Other cooking containers	10
3	Use	11
3.1	Instructions	11
3.2	First use	12
3.3	Using the accessories	12
3.4	Using the oven	13
3.5	Cooking advice	31
3.6	Special functions	32
3.7	Secondary menu	37
4	Cleaning and maintenance	40
4.1	Instructions	40
4.2	Cleaning the surfaces	40
4.3	Ordinary daily cleaning	40
4.4	Food stains or residues	40
4.5	Removing the door	40
4.6	Cleaning the door glazing	41
4.7	Removing the internal glass panes	41
4.8	Cleaning the inside of the oven	43
4.9	Cleaning the tank	45
4.10	Vapour Clean	48
4.11	Extraordinary maintenance	50
5	Installation	52
5.1	Electrical connection	52
5.2	Cable replacement	52
5.3	Positioning	53

We advise you to read this manual carefully, which contains all the instructions for maintaining the appliance's aesthetic and functional qualities.

For further information on the product: www.smeg.com



Instructions

1 Instructions

1.1 General safety instructions

Risk of personal injury

- During use the appliance and its accessible parts become very hot. Children must not come near the appliance.
- Never touch the heating elements during use.
- Keep children under eight years of age at a safe distance if they are not constantly supervised.
- Children must never play with the appliance.
- Never rest metallic objects such as knives, forks, spoons and lids on the appliance during use.
- Switch off the appliance immediately after use.
- Never try to put out a fire or flames with water: Turn off the appliance and smother the flames with a fire blanket or other appropriate cover.
- The appliance must never be cleaned by unsupervised children.
- Do not clean the appliance immediately after turning it off – wait for it to cool down first.

- Have authorised persons carry out installation and assistance interventions according to the standards in force.
- Do not modify this appliance.
- Do not insert pointed metal objects (cutlery or utensils) into the slots in the appliance.
- Do not try to repair the appliance yourself or without the intervention of authorised persons.
- If the power supply cable is damaged, contact technical support immediately and they will replace it.

Risk of damaging the appliance

- Do not use abrasive or corrosive detergents (e.g. scouring powders, stain removers and metallic sponges) on glass parts, as this could cause breakage.
- Use wooden or plastic utensils.
- Do not seat on the appliance.
- Do not use steam jets to clean the appliance.
- Do not obstruct ventilation openings and heat dispersal slots.
- Never leave the appliance unattended during cooking operations where fats or oils could be released.



- Never leave objects on the cooking surface.
- Do not use the appliance to heat rooms for any reason.
- Do not remove the seal on the face of the oven.

For this appliance

- Ensure that the appliance is switched off before replacing the bulb.
- Do not rest any weight or sit on the open door of the appliance.
- Take care that no objects are stuck in the doors.

1.2 Manufacturer liability

The manufacturer declines all liability for damage to persons or property caused by:

- Use of the appliance other than that specified;
- Non-observance of the user manual provisions;
- Tampering with any part of the appliance;
- Use of non-original spare parts.

1.3 Appliance purpose

- This appliance is intended for cooking food in the home environment. Every other use is considered improper.
- This appliance may be used by children aged at least 8 and by persons of reduced physical, sensory or mental capacity, or lacking in experience in the use of electrical appliances, provided that they are supervised or instructed by adults who are responsible for their safety.
- The appliance is not designed to operate with external timers or with remote-control systems.

1.4 Disposal



This appliance must be disposed of separately from other waste (Directives 2002/95/EC, 2002/96/EC, 2003/108/EC). The appliance does not contain substances in quantities sufficient to be considered hazardous to health and the environment, in accordance with current European directives.

To dispose of the appliance:

- Cut the power supply cable and remove it along with the plug.



Power voltage Danger of electrocution

- Disconnect the mains supply.
- Unplug the appliance.



Instructions

- Deliver the appliance to the appropriate recycling centre for electrical and electronic equipment waste, or return it to the retailer when purchasing an equivalent product, on a one for one basis.

Our appliances are packed in non-polluting and recyclable materials.

- Deliver the packing materials to the appropriate recycling centre.



Plastic packaging Danger of suffocation

- Do not leave the packaging or any part of it unattended.
- Do not let children play with the packaging plastic bags.

1.5 Identification plate

The identification plate bears the technical data, serial number and brand name of the appliance. Do not remove the identification plate for any reason.

1.6 This user manual

This user manual is an integral part of the appliance and must therefore be kept in its entirety and within the user's reach for the whole working life of the appliance.

Read this user manual carefully before using the appliance.

1.7 How to read the user manual

This user manual uses the following reading conventions:

Instructions



General information on this user manual, on safety and final disposal.

Description



Description of the appliance and its accessories.

Use



Information on the use of the appliance and its accessories, cooking advice.

Cleaning and maintenance



Information for proper cleaning and maintenance of the appliance.

Installation



Information for authorised persons: Installation, operation and inspection.



Safety instructions



Information



Advice

1. Sequence of instructions for use.

- Standalone instruction.



2 Description

2.1 General Description

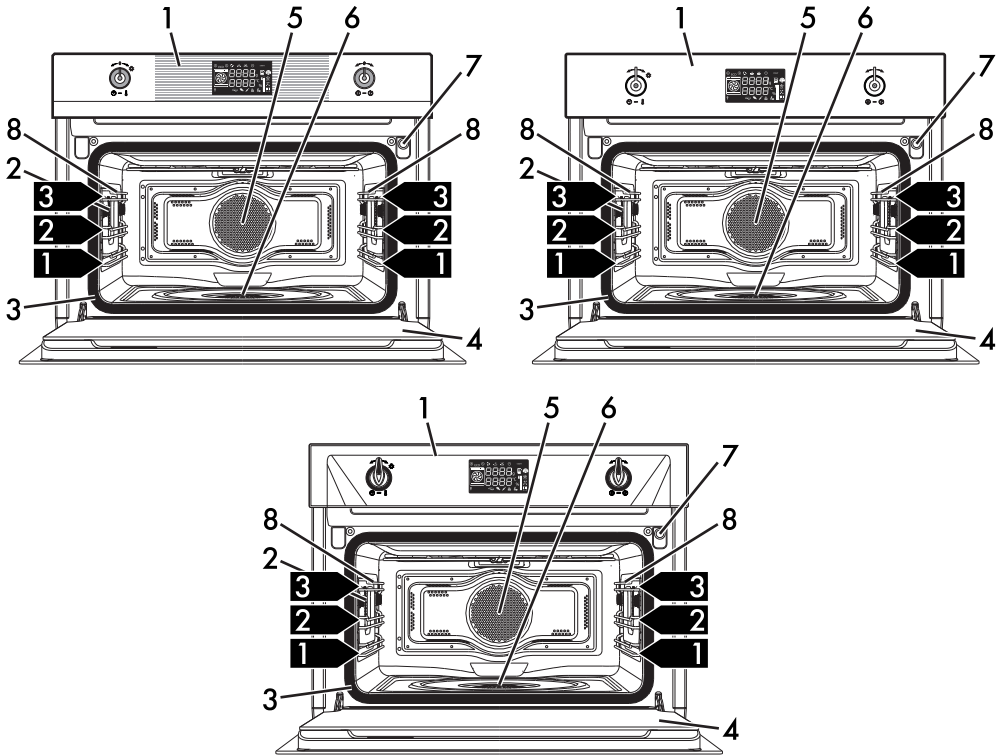

- 1 Control panel
- 2 Oven light
- 3 Seal
- 4 Door

- 5 Fan
- 6 Evaporation tray
- 7 Water supply tube
- 8 Rack support frames

1,2,3 Frame shelf



Description

2.2 Control panel

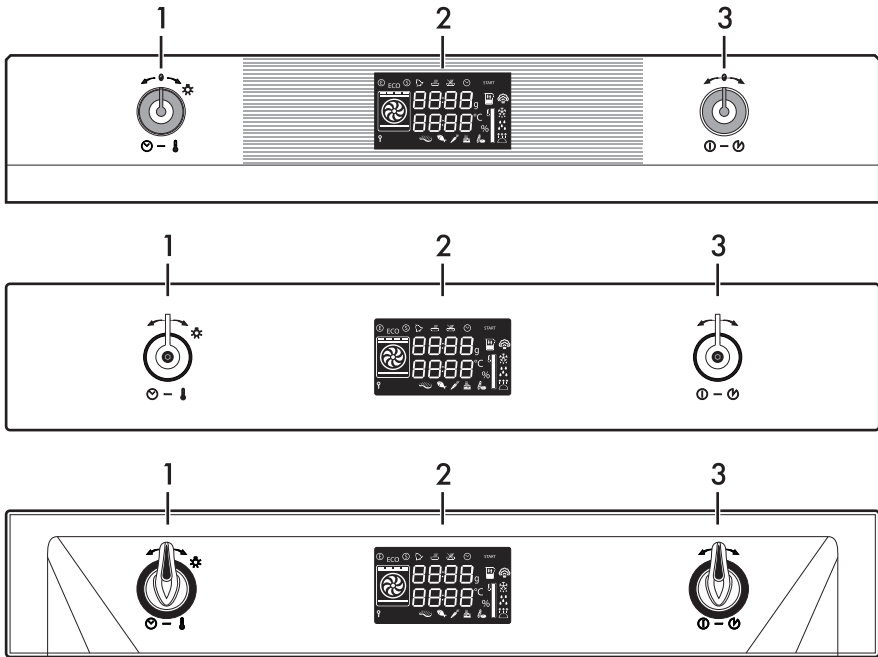

1 Temperature knob

This knob can be used to select:

- The cooking temperature
- The duration of a function
- Programmed cooking procedures
- The current time
- The turning on or off of the light inside the appliance.

2 Display

Displays the current time, the selected cooking temperature and function and any time set.

3 Function knob

This knob can be used to:

- Turn the appliance on and off
- Select a function
- Start or stop a function.



2.3 Other parts

Shelves

The appliance features shelves to position trays and racks at different heights. The insertion heights are indicated from the bottom upwards (see 2.1 General Description).

Cooling fan

The fan cools the oven and comes into operation during cooking.

The fan causes a steady outflow of air from above the door which may continue for a brief period of time even after the appliance has been turned off.

Interior lighting

The appliance interior lighting comes on:

- When the door is opened
- When any function is selected
- When you turn the temperature knob to the right (turn the temperature knob to the right again to turn off the interior lighting).



When the door is open, it is not possible to turn off the interior lighting.

2.4 Available accessories

Perforated tray

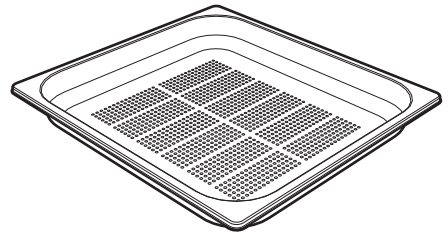

Useful for steaming fish and vegetables.

Tray

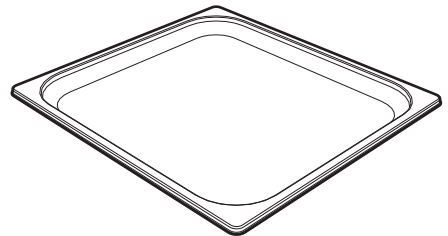

Useful for cooking desserts (with cooking duration less than 25 minutes, or without steam), rice, vegetables and cereals, this is also essential for collecting liquids resulting from steaming or defrosting foodstuffs contained in the perforated tray above.



Description

Rack

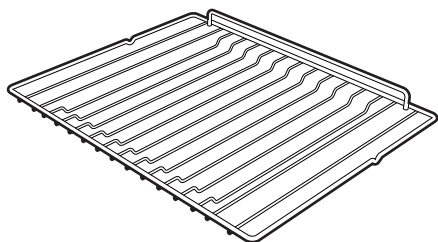

Useful for supporting containers with food during cooking.

Evaporation tray cover

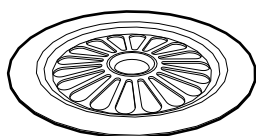

Evenly distributes steam inside the oven.

Sponge

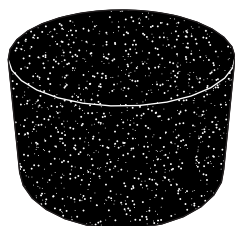

Useful for removing condensation from inside the oven.



The appliance accessories intended to come into contact with food are made of materials that comply with the provisions of current legislation.



Supplied original and optional accessories can be requested to Authorised Assistance Centres. Use only original accessories supplied by the manufacturer.

2.5 Other cooking containers

- You may also use your own containers for cooking, as long as they are resistant to high temperatures.
- For steam cooking, the use of metal containers is recommended. Metal facilitates better distribution of heat to the foods.
- It is normal for metal containers to deform somewhat during high-temperature cooking, but they will return to their original shape when they cool.
- Thick ceramic plates may require more heat than normal. Longer cooking times may be necessary.



Some models are not provided with all accessories.



3 Use

3.1 Instructions



High temperature inside the oven during use
Danger of burns

- Keep the oven door closed during cooking.
- Protect your hands by wearing oven gloves when moving food inside the oven.
- Open the appliance door carefully during or after cooking.
- Take care because steam may not be visible at certain temperatures.
- Do not cook dishes containing large quantities of strong alcoholic beverages. Alcohol vapour inside the oven could ignite.
- Do not touch the heating elements inside the oven.
- Do not pour water directly onto very hot trays.
- Do not allow children to approach the appliance when it is in operation.



Improper use

Risk of damage to enamelled surfaces

- When steaming, always place the tray below the perforated tray in order to catch any drips.
- Do not cover the bottom of the oven cavity with aluminium or tin foil sheets.
- The base of the oven and the evaporation tray must always be left free.
- Dishes must be heat and steam resistant.
- Do not use silicone moulds when steaming.
- If you wish to use greaseproof paper, place it so that it will not interfere with the hot air circulation inside the oven.
- Do not place pans or trays directly on the bottom of the oven cavity.
- Do not pour water directly onto very hot trays.



Use



High temperature inside the oven during use

Danger of fire or explosion

- Do not spray any spray products near the appliance.
- Do not use or leave flammable materials near the appliance.
- Do not use plastic kitchenware or containers when cooking food.
- Do not put sealed tins or containers in the oven.
- Do not leave the appliance unattended during cooking operations where fats or oils could be released.
- Remove all trays and racks which are not required during cooking.

3.2 First use

1. Remove any protective film from the outside or inside of the appliance, including accessories.
2. Remove any labels (apart from the technical data plate) from the accessories and from the oven cavity.
3. Remove and wash all the appliance accessories (see 4 Cleaning and maintenance).
4. Heat the empty oven at the maximum temperature for at least 20 minutes to burn off any residues left by the manufacturing process (see 3.4 Using the oven).
5. You must set the current time in order to start using the appliance (see "Setting the time").

3.3 Using the accessories

Racks

The racks must be inserted into the side guides until they come to a complete stop.

- The mechanical safety locks that prevent the rack from being taken out accidentally have to face downwards and towards the oven back.

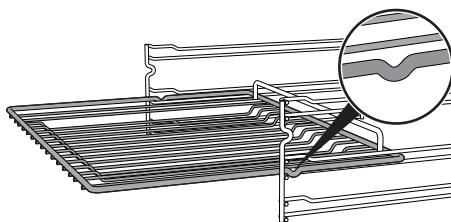

Gently insert the racks into the oven until they come to a stop.



Clean the racks and trays before using them for the first time to remove any residues left by the manufacturing process.



Trays

The tray must be inserted in the groove in the rack.

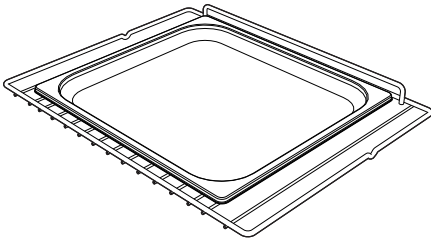

In particular, the perforated tray must be inserted in the groove in the rack above it. This allows liquids to be collected separately from the food which is being cooked.

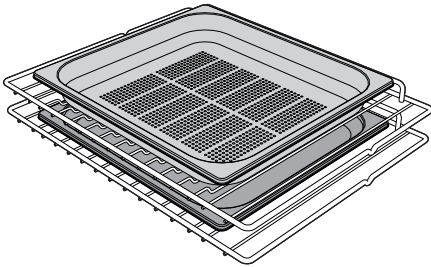

3.4 Using the oven

Display

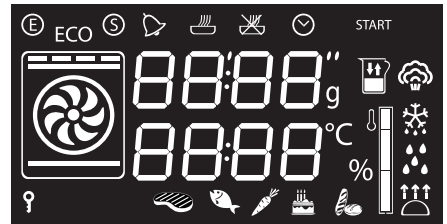

- Eco-logic indicator light
- Showroom indicator light
- Minute minder timer indicator light
- Timed cooking indicator light
- Programmed cooking indicator light
- Clock indicator light
- Child lock indicator light
- Temperature indicator light
- Tank level indicator light
- Steam indicator light
- Defrost indicator light
- Vapour Clean indicator light
- Proving indicator light



Use

Setting the time

On the first use, or after a power failure, **00:00** will be flashing on the appliance's display. To be able to start any cooking function, the current time must be set.

1. Turn the temperature knob to set the displayed time (keep the knob turned to produce a faster increase or decrease).
2. Press the temperature knob.
3. Turn the temperature knob to set the minutes (keep the knob turned to produce a faster increase or decrease).
4. Press the temperature knob to finish adjustment.



It may become necessary to change the current time, for example for daylight saving time. From the stand-by position, keep the temperature knob turned to the right until the hours flash.

It is not possible to change the time if a function is active.

Operating modes

Stand-by: When no function is selected, the display shows the current time.

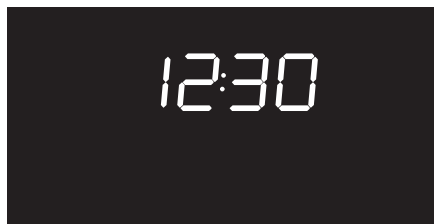

ON: When a function is activated, the display shows the parameters set such as temperature, duration and temperature reached.



Steaming foods

Each time the temperature knob is pressed during a function, the parameters will be cycled through in the following order.



Timed cooking duration



Temperature







Programmed cooking time







Traditional cooking

Each time the temperature knob is pressed during a function, the parameters will be cycled through in the following order.

-  Temperature
-  Minute minder
-  Timed cooking duration
-  Programmed cooking time (if timed cooking is set).

Combination cooking

Each time the temperature knob is pressed during a function, the parameters will be cycled through in the following order.

-  Timed cooking duration
-  Temperature
-  Steam percentage
-  Programmed cooking time

In all modes it is possible to modify the value by turning the temperature knob to the left or right. Keep the knob turned to produce a faster increase or decrease.

Steaming settings

i Do not place food or any other object directly on the bottom of the oven. The base of the oven and the evaporation tray must always be left free.

1. Place the food inside the oven.
2. Press the function knob to activate the appliance. The timed cooking indicator light  will flash.

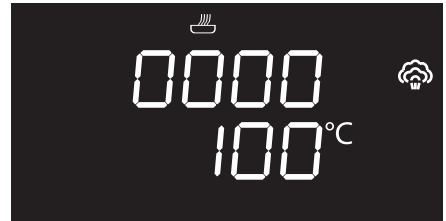

3. Turn the temperature knob to the right or left to set the steaming duration from 00:01 to 02:00. Keep the knob turned for a fast increase or decrease.





Use

- Press the temperature knob to confirm the required cooking duration. The timed cooking indicator light  remains on steadily, while the temperature indication **100°C** starts flashing.
- If you wish to modify the default temperature (100°C), turn the temperature knob to the left or right until you reach the required value.

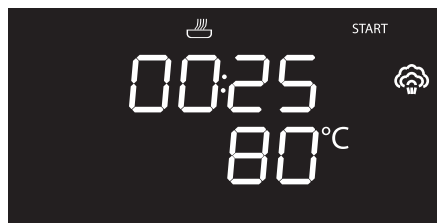

At this point it is possible to set programmed cooking.

i Programmed cooking is the function which allows cooking to be stopped at an established time depending on the time set by the user, after which the oven will switch off automatically.

If you do not wish to set timed cooking, just wait a few seconds until the indicator light

START starts flashing, otherwise continue from step 10.

If you do wish to set timed cooking, proceed as follows:

- While the programmed cooking indicator light  is flashing, turn the temperature knob to the right or left to set the cooking end time.

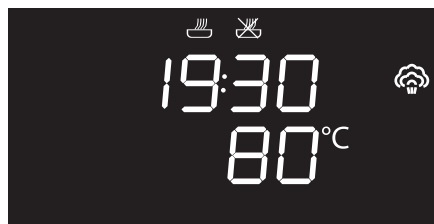

- Press the temperature knob to confirm the cooking end time. The programmed cooking indicator light  remains on steadily.
- After a few seconds, the indicator light **START** flashes on the display.

i The minimum temperature which can be set is 30°C. Each movement of the temperature knob changes the value by 5°C.

- Press the temperature knob to confirm the cooking temperature set. The temperature indication remains steady, while the programmed cooking indicator light  starts flashing.

 If cooking has just been performed with temperatures greater than 100°C, you must wait for the oven to cool in order to use the steaming function.



10. Press the function knob. A request to fill the tank with water is shown on the display.



Filling the tank



- Use cold tap water which is not too hard, softened water or still mineral water.
- Do not use distilled water, tap water with a high chloride content (> 40 mg/l), or other liquids.

11. Fill a container (e.g. a jug) with sufficient water for the cooking duration.
12. Open the oven door.
13. Rest the container on the open door.



Note: the container with the water must have a gross weight lower than 5 kg.

14. Extract the tube from its seat and immerse its end in the container until it reaches all the way to the bottom.

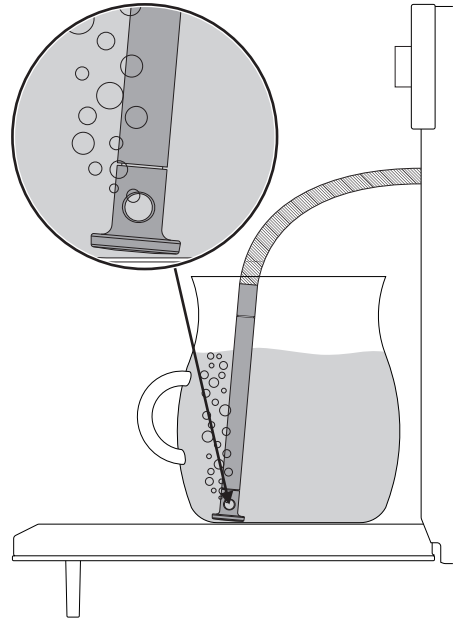

15. Press the function knob to start drawing water into the appliance's tank.



The appliance will automatically draw the quantity of water necessary for cooking on the basis of the set duration.



In the event that the water runs out, the appliance will automatically stop the cooking process, a buzzer will sound and the display will show a request to fill the tank with water.



Use

16. When the appliance has finished taking in water, shake the tube to remove any residual water.

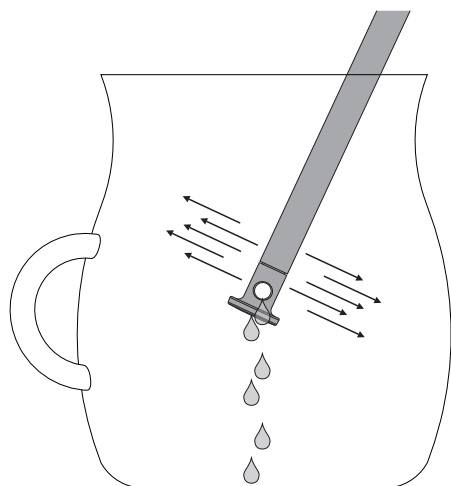

17. Return the tube to its original position, remove the container of water and close the door.

i When the door is closed, an automatic system will automatically draw in any residual water in the tube to avoid drips. A bubbling noise may be heard; this is completely normal.

18. Press the function knob to start steaming.



Cooking can be interrupted at any time by pressing and holding the function knob for a few seconds.



Each time the door is opened, the function in progress will stop and then automatically restart when the door is closed again.

Preheating stage

Steaming is always preceded by a preheating stage, which allows the appliance to heat up to cooking temperature.

The temperature reached flashes to indicate that this stage is in progress.

When preheating finishes, the temperature reached remains lit steadily, a buzzer sounds and cooking proceeds automatically.



Modifying the set data

During operation, it is possible to modify the cooking duration:

19. When the timed cooking indicator light



is lit steadily and cooking is in progress inside the appliance, press the temperature knob. The timed cooking

indicator light  will start flashing.



i

If you set a longer cooking time than that previously set - meaning that the water added to the tank will be insufficient - the indicator light  will flash on the display for a few seconds. Cooking will proceed regardless, but when the tank is empty a request to add water will be shown on the display.



20. Turn the temperature knob right or left to alter the pre-set cooking time.







i

Towards the end, the appliance automatically switches off its heating elements in order to finish cooking using the residual heat inside the oven cavity.

Modifying programmed cooking



If programmed cooking is set, after modifying the cooking time, the end of cooking time must be re-set.

21. When the timed cooking  and programmed cooking  indicator lights are lit steadily and the appliance is waiting for cooking to start, press the temperature knob. The timed cooking indicator light  will start flashing.
22. Turn the temperature knob right or left to alter the pre-set cooking time.
23. Press the temperature knob again. The timed cooking indicator light  switches off and the programmed cooking indicator light  starts flashing. The display shows the cooking end time.
24. Turn the temperature knob right or left to delay the cooking end time.
25. After a few seconds the timed cooking  and programmed cooking  indicator lights stop flashing and programmed cooking restarts with the new settings.



End of steaming

When steaming finishes, a buzzer will sound and the following screens will alternate on the display.



To select further cooking, turn the temperature knob right or left again.

26. Press the function knob to stop the buzzer.
27. Stand to the side of the appliance and open the door ajar for a few seconds to allow excess steam to escape.
28. Fully open the door when safe to do so and cautiously remove the food from the oven.

Removing the residual water



We recommend emptying the tank each time you finish using the appliance to avoid scale build-up.

29. Remove the cover from the evaporation tray and dry it with the sponge supplied.

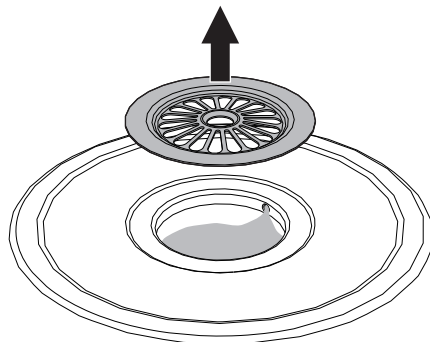

Note: The evaporation tray cover may be very hot: use appropriate protection.

30. We recommend inserting the supplied sponge into the evaporation tray.
 31. Press the function knob to begin draining residual water from the tank.
- The residual water is discharged into the evaporation tray: as well as facilitating removal, this contributes to cooling down the oven more quickly.



If the remaining quantity of water is over 500 ml, the water will be discharged into the evaporation tray in two different steps to facilitate drying. The display will show "STEP 1" when the first stage has finished, and draining will stop. You must press the function knob again to complete the draining with "STEP 2". When this has completed, "END" will be displayed.



If you do not wish to proceed with draining the tank, hold down the function knob for a few seconds.

32. Squeeze out the excess water into a separate container.



Take care: the water may be very hot.

33. Also remove condensation from the base and walls of the oven, the door glass and drip tray and the front of the appliance.

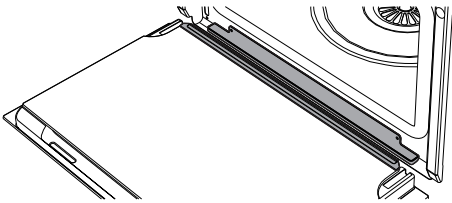

Advice for steam cooking

- **Pasta and rice:** upon reaching 100°C, the cooking time will be the same as with cooking on a hob. Place the pasta or rice in a metal tray and cover with around a centimetre of water. For best results when cooking rice, place a lid on the container or cover with aluminium foil. This procedure allows the rice to absorb all the water, and it can then be served directly to the table.
- **Eggs:** these may be **boiled**, **scrambled** or **poached** by using the steam function at 100°C. To obtain perfect **boiled eggs**, place them on a perforated tray and cook for 4-6 minutes for soft boiled eggs and 8-10 minutes for hard-boiled eggs. For **scrambled eggs**, place the beaten eggs in a metal tray together with milk, butter and seasoning. Cover the tray with aluminium foil. Mix every couple of minutes using a fork. For **poached eggs**, pour boiling water into the metal tray with a drop of vinegar and steam cook for around 4-5 minutes.
- **Vegetables:** steam cooking vegetables gives excellent results. They maintain their colour, flavour and nutritional properties. For dense vegetables such as potatoes, turnips and parsnips, cook at 100°C for the same length of time you would boil them on a hob. For broccoli and carrots, cook for 6 minutes if you want them to remain firm, or 10 minutes if you want them to be softer.



Use

- **Fish:** due to the delicate nature of fish, steaming gives excellent results. For oily fish such as salmon or trout, cook at 100°C for around 5 minutes. For white fish such as cod or haddock, cook at 80°C for around 5 minutes. If you are cooking different foods, all fish must be cooked in the perforated tray which must be placed on the bottom shelf of the oven to avoid liquid from the fish dripping onto other food products.
- **Meat:** this can also be steamed, but the use of a combined cooking function is preferable in order to obtain a nicely browned result. Casseroles and curries are ideal for steam cooking, however. Prepare the casserole as for normal oven cooking. Place it in a metal tray, cover with a lid or aluminium foil, and cook for between 45 minutes and 3 hours depending on the cut of meat used.
- **Thin soups:** steam cooking allows flavours to develop perfectly with minimum effort, as the liquids will not boil over. For vegetable soup with the correct consistency, first steam the vegetables, then add broth and steam cook at 100°C. The steam function is also ideal for preparing large quantities for later use.
- **Soups:** Thicker soups are also easy and quick to prepare. Place the soup in a metal tray, cover with a lid or aluminium foil and steam cook at 100°C for the same time you would cook it in a microwave oven. Mix midway through cooking for a creamier consistency.
- **Reheating:** using the steam cooking function will not dry foods out and gives a moister result. A previously prepared home-cooked meal, covered with aluminium foil, will take around 10-12 minutes to reheat. Ready meals will require approximately double the time indicated on the package.
- **Defrosting:** it is possible to use the steam cooking function to defrost foods. Times vary, but defrosting with the steam cooking function takes around half the time necessary for covered foods left to defrost at room temperature.
- **Peeling peppers and tomatoes:** this otherwise time-consuming operation is very simple when you use the steam cooking function. Use a knife to cut a small cross in the skin of the tomato, and steam cook for 1 minute. Peppers have tougher skin, and may require up to 4 minutes to soften them sufficiently for peeling.
- **Chocolate:** this can be melted using the steam cooking function. Place the chocolate in a metal tray, cover with aluminium foil and steam cook for 1 minute. Unlike other methods, chocolate is unlikely to burn in the steam oven.
- **Hot towels:** ideal for facial treatments, a close shave or for use after a meal, these are easy to prepare using the steam cooking function. Moisten a towel with water, roll it up and steam it for 1 minute.



Combination cooking functions



Combined cooking functions are ideal for preparing moist cakes and bread and for tender roast meats.

Combination functions list





Steam + fan forced

The combination of the fan, the circular heating element and the steam is particularly suitable for preparing roast meats, chicken and baked goods such as bread and leavened sweets.





Steam + fan assisted

The operation of the fan combined with traditional cooking, with the assistance of steam, ensures uniform cooking even with complex recipes. Ideal for roast veal, roast duck and cooking whole fish.

1. Press the function knob to activate the appliance.
2. Turn the function knob to the right or left to set a combination function.
3. Turn the temperature knob to set the combination cooking duration .
4. Press the temperature knob  if you wish to change the default temperature.

5. Turn the temperature knob to the right or left to select the required temperature



6. Press the temperature knob if you wish to change the steam percentage  (25% by default).
7. Turn the temperature knob to the right or left to select the required percentage of steam .
8. Press the function knob. A request to fill the tank with water is shown on the display.

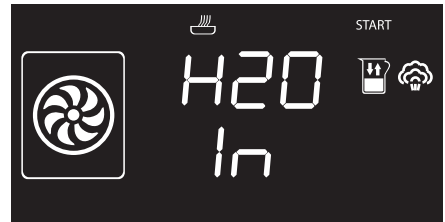

9. Fill the tank as described in chapter "Filling the tank".
10. Press the function knob to start combination cooking.





Preheating stage

Combination functions are always preceded by a preheating stage, which allows the appliance to heat up to cooking temperature.

The temperature reached flashes to indicate that this stage is in progress.

When the preheating stage is complete, the temperature reached will remain lit steadily and a buzzer will sound to indicate that the food can be placed inside the oven.

This stage is performed without the use of steam.

Then press the function knob to start cooking.



Traditional cooking functions

1. Press the function knob to activate the appliance.
2. Turn the function knob to the right or left to select a traditional function.
3. Press the temperature knob **°C** if you wish to change the default temperature.
4. Turn the temperature knob to the right or left to select the required temperature **°C**.
5. Press the function knob to start traditional cooking.

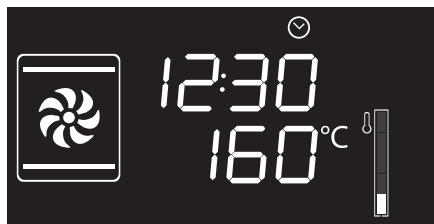

Cooking can be interrupted at any time by pressing and holding the function knob for at least 3 seconds, or by opening the door.

Steam percentage	Type of food
25%	Breads and cakes
30%	Duck
40%	Beef, veal and lamb
50%	Chicken and chops
70%	Whole fish



Preheating stage

Traditional functions are always preceded by a preheating stage, which allows the appliance to heat up to cooking temperature.

The temperature reached flashes to indicate that this stage is in progress.



When preheating finishes, the temperature reached remains lit steadily, a buzzer sounds and cooking proceeds automatically.



With traditional cooking, food can be placed in the oven immediately or after preheating, as the user prefers.



Cooking can be interrupted at any time by pressing and holding the function knob for at least 3 seconds, or by opening the door.

Traditional functions list



Fan forced

The combination of the fan and the circular heating element (incorporated in the rear of the oven) allows you to cook different foods on several levels, as long as they need the same temperatures and type of cooking. Hot air circulation ensures instant and even distribution of heat. It will be possible, for instance, to cook fish, vegetables and biscuits simultaneously (on different levels) without odours and flavours mingling.



Grill

The heat coming from the grill element gives perfect grilling results above all for thin and medium thickness meat and, in combination with the rotisserie (where fitted), gives the food an even browning at the end of cooking. Ideal for grilled cheese and gratinating. This function enables large quantities of food, particularly meat, to be grilled evenly.



ECO Eco



The combination of the fan and the circular heating element, in ECO mode, is particularly indicated for cooking on a single shelf, with reduced power consumption.



Convection

As the heat comes from above and below at the same time, this system is particularly suitable for certain types of food. Traditional cooking, also known as static cooking, is suitable for cooking just one dish at a time. Ideal for pies, bread and casseroles. It is also suitable for fatty meat such as duck and goose.



Fan assisted

The operation of the fan, combined with traditional cooking, ensures consistent cooking even with complex recipes. Perfect for roasts.



Fan grill

The air produced by the fan softens the strong heatwave generated by the grill, grilling perfectly even very thick cuts of meat such as steaks, pork chops etc.



Fan forced + bottom

Fan assisted cooking is combined with the heat coming from the bottom and allows you at the same time to slightly brown food. Ideal for flans, quiches and pizza.



Supercook

The combination of fan assisted cooking and traditional cooking allows different foods to be cooked on several levels extremely quickly and efficiently, without odours and flavours mingling. Perfect for large volumes that call for intense cooking.

To obtain a rotisserie effect, set the temperature to maximum. When the appliance reaches maximum temperature, return the temperature to normal. This procedure seals the liquids inside the meat, and reduces shrinkage.





Minute minder

i This function only activates the buzzer, without stopping cooking.

i The minute minder can be activated both during cooking and when the appliance is in standby.

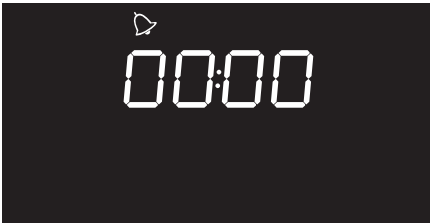
1. Press the temperature knob once (twice if cooking is already in progress). The display shows **00:00** and the indicator light  flashes.



2. Turn the temperature knob to set the duration (from 1 minute to 4 hours). After a few seconds, the indicator light  stops flashing and the countdown starts.
3. Select the required cooking function and wait for the buzzer to sound, indicating that the cooking time is over. The indicator light  flashes.
4. Turn the temperature knob to select another minute minder, or press the temperature knob to stop the buzzer.

 You must set the value to zero to remove the minute minder.

Timed cooking

i Timed cooking is the function which allows a cooking operation to be started and then ended after a specific length of time set by the user.

i Activation of timed cooking cancels any minute minder timer which may previously have been set.

1. After selecting a cooking function and temperature, press the temperature knob three times. The display shows **00:00** and the indicator light  flashes.

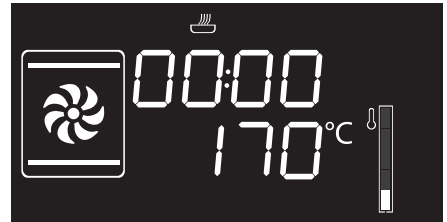

2. Turn the temperature knob right or left to set the cooking duration from 00:01 to 12:59. Keep the knob turned to produce a faster increase or decrease.

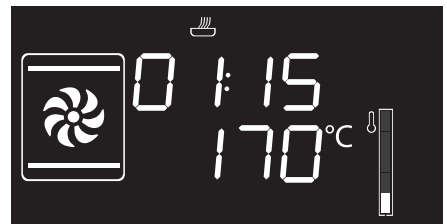





Use

3. A few seconds after the required duration is set, the indicator light  stops flashing and timed cooking starts.
4. At the end of the cooking time STOP appears on the display and a buzzer sounds that can be deactivated by pressing the temperature knob.



Modifying the data set during timed cooking

During operation, it is possible to modify timed cooking duration:

1. When the indicator light  is steady and cooking is in progress inside the appliance, press the temperature knob twice. The indicator light  starts flashing.
2. Turn the temperature knob right or left to alter the pre-set cooking time.



To select a further timed cooking, turn the temperature knob right or left again.



To extend the cooking time manually, press the temperature knob again. The appliance resumes its normal operation with the previously selected cooking settings.



Press and hold the function knob down to switch off the appliance.



Programmed cooking

i Programmed cooking is the function which allows cooking to be stopped at an established time depending on the time set by the user, after which the oven will switch off automatically.

1. After selecting a cooking function and temperature, press the temperature knob three times. The display shows

and the indicator light flashes.

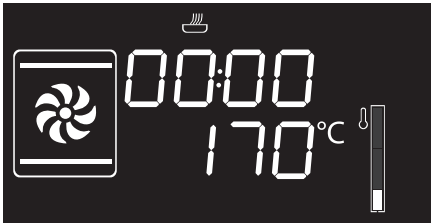

2. Turn the knob right or left to set the cooking duration from 00:01 to 12:59. Keep the knob turned for a fast increase or decrease.

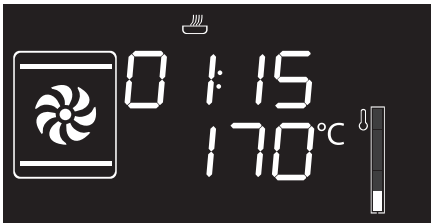

3. Press the temperature knob a fourth time.

The indicator light flashes. Turn the knob right or left to set the cooking end time.

4. After a few seconds the indicator lights and stop flashing. The appliance waits for the set start time.

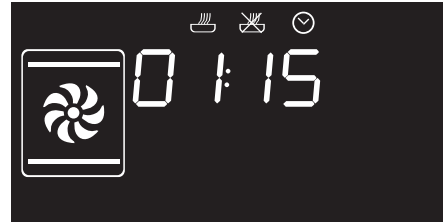



- At the end of the cooking time STOP appears on the display and a buzzer sounds that can be deactivated by pressing the temperature knob.



To extend the cooking time manually, press the temperature knob again. The appliance resumes its normal operation with the previously selected cooking settings.



Press and hold the function knob down to switch off the appliance.









For safety reasons, it is not possible to set the end of cooking time by itself without setting the cooking duration.

Modifying the data set during programmed cooking



After modifying the cooking duration, the end of cooking time must be re-set.

During operation, it is possible to modify the programmed cooking duration:

- When the indicator lights  and  are lit steadily and the appliance is waiting for cooking to start, press the temperature knob twice. The indicator light  starts flashing.
- Turn the temperature knob right or left to alter the pre-set cooking time.
- Press the temperature knob again. The indicator light  switches off and the indicator light  starts flashing. The display shows the cooking end time.
- Turn the temperature knob right or left to delay the cooking end time.
- After a few seconds the indicator lights  and  stop flashing and programmed cooking resumes its operation with the new settings.



3.5 Cooking advice

General advice

- It is not possible to shorten cooking times by increasing the temperature (the food could be overcooked on the outside and undercooked on the inside).
- Cooking times vary according to the thickness and quality of the food and to consumer taste.
- The first few times you use the appliance, until acquiring sufficient confidence and knowledge of the required cooking times, we suggest setting slightly longer cooking times and testing the food quickly a little before cooking ends. In this manner, if the food is not yet ready you will be able to continue cooking without the need to add more water to the tank thanks to the remaining time. If, however, the food is already cooked, it will be possible to immediately stop cooking and drain the residual water from the tank.

Advice for cooking desserts/pastries and biscuits

- Use dark metal moulds: They help to absorb the heat better.

Advice for steam cooking

- Cooking times depend on the density of foods and not their quantity. For example, one piece of broccoli will take the same time as 20 florets. Increasing the quantity of a casserole also increases its density, and so the cooking time will also increase.
- Where possible, use a perforated container to allow the steam to circulate around the food from all sides.
- Steam cooking significantly reduces the migration of flavours between different foodstuffs. Nevertheless, always ensure foods like fish cooked in a perforated tray are placed at the bottom of the oven.
- If the steam is likely to change the consistency of the foods being cooked (e.g. casseroles, puddings) always cover them with aluminium foil.

To save energy

- Reduce any opening of the door to a minimum to avoid heat dispersal.
- Keep the inside of the appliance clean at all times.



3.6 Special functions

Defrost by time



It is not possible to modify the temperature of the defrost by time function.

1. Place the food to be defrosted inside the oven.
2. Press and turn the function knob to select the defrost by time function marked by the indicator lights and .
3. Press the function knob to confirm your choice of function.
4. Turn the temperature knob to set the defrost duration (from 00:00 to 13:00).
5. Press the function knob to start defrosting.
6. At the end, the word STOP will be displayed.



IMPORTANT: always fully defrost foods before cooking



- Place frozen foods without their packaging in a lidless container on the first shelf of the oven.
- Avoid overlapping the food.
- To defrost meat, use the rack placed on the second level and a tray on the first level. In this way, the liquid from the defrosting food drains away from the food.

Proving

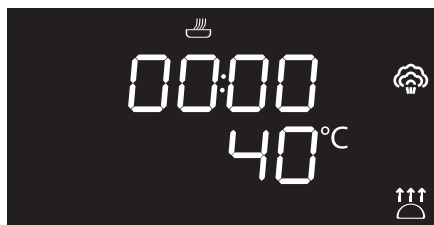

It is not possible to modify the temperature of the proving function.

1. Place the dough to be proved inside the oven.
2. Press and turn the function knob to select the proving function marked by the indicator lights and .
3. Press the function knob to confirm your choice of function.



4. Turn the temperature knob to set the proving duration (from 00:00 to 13:00).
5. Press the function knob to start the proving function.
6. At the end, the word STOP will be displayed.

Heating

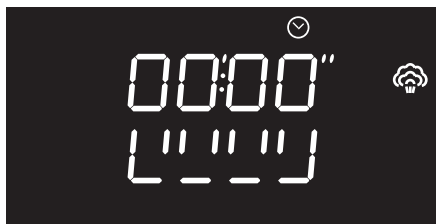

i This function allows you to heat previously cooked food which has been kept in the refrigerator.

1. Place the food to be heated inside the oven.
1. Press and turn the function knob to select the heating function.
2. Turn the temperature knob to modify the heating duration.
3. Press the function knob to confirm the parameters and start heating.

Sabbath mode



i This mode allows food to be cooked while respecting the requirements of the Jewish Sabbath.

 The appliance follows some specific behaviour when operating in this mode:

- Cooking can proceed indefinitely, it is not possible to set any time.
- No preheating will be performed.
- The cooking temperature which can be selected varies between 60-100 °C.
- Oven light disabled, any operation such as opening the door or manual activation with the knob will not activate the light.
- Oven fan disabled.
- Knob lights and buzzers disabled.



Use



After activating the Sabbath mode it will no longer be possible to modify any parameters.

Any action on the knobs will produce no effect; only the function knob remains active to allow the appliance to be turned off.

1. Press the function knob to select the Sabbath mode.
2. Press the temperature knob.
3. Turn the temperature knob to modify the heating duration.
4. Press the function knob to confirm the parameters and start the Sabbath mode.
5. When finished, press and hold the function knob down for at least 3 seconds to turn off the appliance.

Defrost by weight

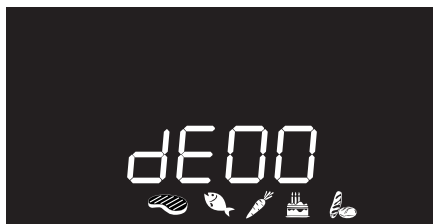

This function defrosts foods on the basis of the type and weight of the frozen product.







It is not possible to modify the temperature of the defrost by weight function.

1. Place the food to be defrosted inside the oven.
2. Press the function knob to select defrost by weight, marked by **dE00** and the illuminated food symbols 
3. Press the function knob to confirm your choice of function.
4. Turn the function knob to select the type of food to defrost.
5. Turn the temperature knob to select the weight (in grams) of the food to defrost.



6. Press the function knob to confirm the parameters and start defrosting.
7. At the end, the word STOP will be displayed.

Preset parameters:

dE	Type	Weight (g)	* Time (minutes)
01 	Meat	500	105
02 	Fish	400	43
03 	Vegetables	300	45
04 	Bread	300	20

*Defrosting times may vary on the basis of the shape and size of the food to be defrosted.

Automatic programs

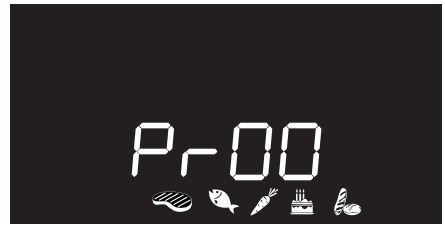

i The automatic cooking programs are divided by the type of food to be cooked.

1. Place the food inside the oven.
2. Press the function knob to select the automatic program, marked by **P-00** and the illuminated food symbols .
3. Turn the function knob to select the required program (see Automatic programs table).
4. Press the function knob to start cooking.



Use

Automatic programs table



MEAT (01 - 04)

Subcategory	Function	Steam %	Weight (g)	Shelf	Temp. (°C)	Time (minutes)
01 Roast pork	+	50	1000	2	180	95
02 Roast veal	+	40	1000	2	170	70
03 Whole roast chicken	+	50	1000	2	200	40
04 Whole roast duck	+	30	2000	2	150	120



FISH (05 - 08)

Subcategory	Function	Steam %	Weight (g)	Shelf	Temp. (°C)	Time (minutes)
05 Fillet of cod (thick pieces of approx. 150 g each)		100	200	2+1	100	6
06 Salmon fillet (medium-thick pieces of approx. 150 g each)		100	200	2+1	100	5
07 Prawns		100	500	2+1	90	5
08 Whole fish	+	70	500	2+1	200	25





VEGETABLES (09 - 12)

Subcategory	Function	Steam %	Weight (g)	Shelf	Temp. (°C)	Time (minutes)
09 Carrots (rounds approx. 3 cm thick)		100	500	2+1	100	6
10 Potatoes (Ø 4-5 cm cut into 4-6 pieces)		100	500	2+1	100	25
11 Cauliflower (in pieces)		100	500	2+1	100	12
12 Asparagus (whole)		100	500	2+1	100	6





DESSERTS/PASTRIES (13 - 16)

Subcategory	Function	Steam %	Weight (g)	Shelf	Temp. (°C)	Time (minutes)
13 Biscuits/muffins (in trays/moulds)		0	600	1	160	18
14 Tarts (in a tray)		0	800	1	170	40
15 Syrup pudding (up to 300 g in moulds, over 400 g in a pudding basin)		100	200	1	100	50
16 Sponge cake	 + 	25	1000	1	165	40



PASTA (17 - 20)

Subcategory	Function	Steam %	Weight (g)	Shelf	Temp. (°C)	Time (minutes)
17 White leavened bread	 + 	25	2000	2	180	30
18 Pasta bake/Lasagne		0	2000	1	220	40
19 Quiche		0	1000	1	200	40
20 Basmati rice		100	200	2+1	100	12

3.7 Secondary menu

The appliance also has a drop-down secondary menu allowing the user to:

- Activate or deactivate the Child lock.
- Activate or deactivate Showroom mode (which disables all the heating elements so that only the control panel works).
- Activate or deactivate Eco-light mode.
- Set the water hardness value.

With the appliance in Stand-by status

1. Activate the internal light by turning the temperature knob quickly.
2. Press and hold the temperature knob down for at least 5 seconds.
3. Turn the temperature knob to the left or right to change the status of the setting (ON/OFF) or to the right to increase the value to set or to the left to decrease it.
4. Press the temperature knob to move to the next mode.



Use

Child lock mode

This mode allows the appliance to lock the controls automatically after one minute of normal operation without any intervention from the user.



During normal operation it is indicated by the indicator light  coming on.

To release the lock temporarily during cooking, hold the temperature knob down for 5 seconds. One minute after the last setting the lock will become active again.



Touching or varying the position of the temperature and function knobs, the display will show "bloc" for two seconds.



It is still possible to turn the appliance off instantaneously by pressing and holding the function knob down for 3 seconds when in child lock mode.

Showroom mode (for exhibitors only)

This mode allows the appliance to deactivate all heating elements, while keeping the control panel active.



To use the appliance normally, set this mode to OFF.



If the mode is active, the indicator light  lights up on the display.

Eco-logic mode

This mode allows the appliance to limit the power used.

Indicated for use of multiple appliances at the same time on circuits with limited maximum power.

HI: normal power.

LO: low power.



Activating eco-logic mode means that preheating and cooking times may be extended.



If the mode is active, the indicator light  lights up on the display.



Keep Warm mode

This mode allows the appliance to keep cooked food warm (at low temperatures) for around an hour after cooking finishes with a cooking cycle for which a duration has been set (if this is not manually interrupted).



Eco-light mode

For greater energy savings, the light is automatically deactivated one minute from the start of cooking.



To stop the appliance from automatically deactivating the light after one minute, set this mode to OFF.



The manual off/on control is always available with both settings by turning the temperature knob to the right.

Water hardness setting mode



The appliance is factory set for water of medium hardness.



This mode allows you to set the water hardness value in order to optimise the descaling process.



It is possible to modify the water hardness setting from the minimum value (one bar)...



... Up to the maximum value (five bars).



Request information on the hardness of your water from your local water board.



If your mains water supply is too hard, we recommend using a water softener.



4 Cleaning and maintenance

4.1 Instructions



Improper use Risk of damage to surfaces

- Do not use steam jets to clean the appliance.
- Do not use cleaning products containing chlorine, ammonia or bleach on steel parts or parts with metallic finishes on the surface (e.g. anodizing, nickel- or chromium-plating).
- Do not use abrasive or corrosive detergents (e.g. scouring powders, stain removers and metallic sponges) on glass parts.
- Do not use rough or abrasive materials or sharp metal scrapers.



Improper use Risk of damage to the appliance

- Do not remove the seal on the face of the oven.

4.2 Cleaning the surfaces

To keep the surfaces in good condition, they should be cleaned regularly after use. Let them cool first.

4.3 Ordinary daily cleaning

Always use only specific products that do not contain abrasives or chlorine-based acids.

Pour the product onto a damp cloth and wipe the surface, rinse thoroughly and dry with a soft cloth or a microfibre cloth.

4.4 Food stains or residues

Do not use metallic sponges or sharp scrapers as they will damage the surfaces. Use ordinary non-abrasive products with the aid of wooden or plastic utensils if necessary. Rinse thoroughly and dry with a soft cloth or a microfibre cloth.

Do not allow residues of sugary foods (such as jam) to set inside the oven. If left to set for too long, they might damage the enamel lining of the oven.

4.5 Removing the door

For easier cleaning, the door can be removed and placed on a canvas.

To remove the door proceed as follows:

1. Open the door completely and insert two pins into the holes on the hinges indicated in the figure.

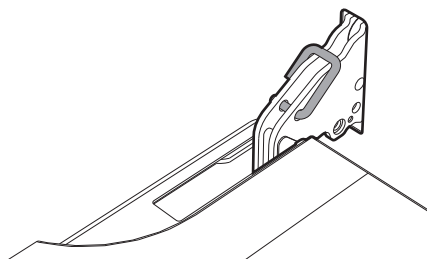



2. Grasp the door on both sides with both hands, lift it forming an angle of around 30° and remove it.



3. To reassemble the door, put the hinges in the relevant slots in the oven, making sure that grooved sections **A** are resting completely in the slots. Lower the door and once it is in place remove the pins from the holes in the hinges.

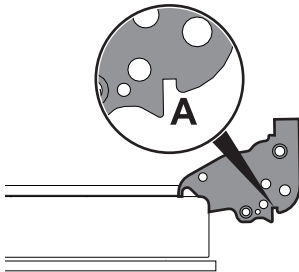

4.6 Cleaning the door glazing

The glass in the door should always be kept thoroughly clean. Use absorbent kitchen roll. In case of stubborn dirt, wash with a damp sponge and an ordinary detergent.



We recommend the use of cleaning products distributed by the manufacturer.

4.7 Removing the internal glass panes

For easier cleaning the door internal glass panes can be disassembled.

1. Open the door.
2. Remove the internal glass pane by pulling the rear part gently upwards, following the movement indicated by the arrows (1).
3. Then, pull the front part upwards (2). This way, the 4 pins attached to the glass detach from their housings in the oven door.

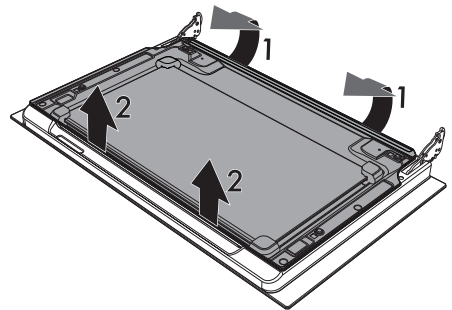



Cleaning and maintenance

4. Raise the intermediate glass unit upwards.

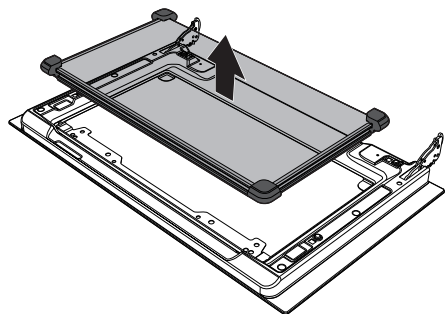

5. Clean the external glass pane and the panes removed previously. Use absorbent kitchen roll. In case of stubborn dirt, wash with a damp sponge and neutral detergent.

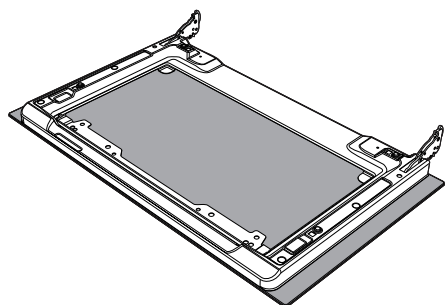

6. Reposition the intermediate glass unit.

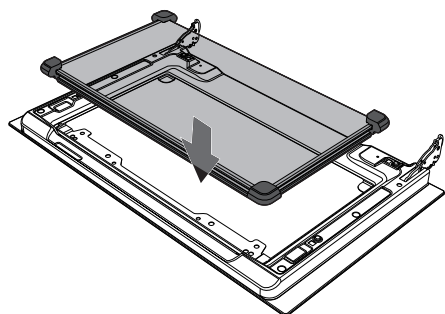

7. The rubber strips **A**, **B** and **C** of the intermediate glass unit must face the outer glass.

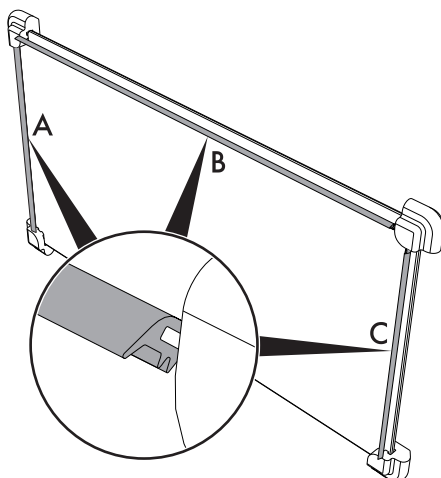

8. Centre and insert the 4 pins into their housings in the oven door by applying slight pressure.

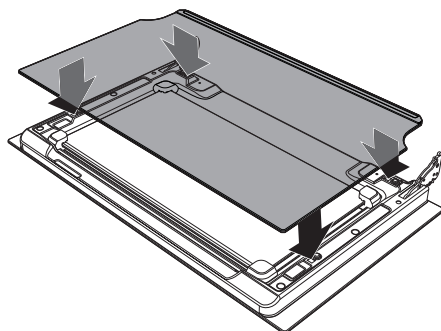



4.8 Cleaning the inside of the oven

For the best oven upkeep, clean it regularly after having allowed it to cool.

Take out all removable parts.

Clean the oven racks with warm water and non-abrasive detergent. Carefully rinse and dry damp parts.

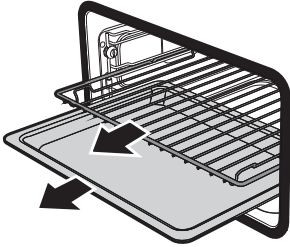

The oven should be operated at the maximum temperature for about 15-20 minutes after the use of specific products, to burn off the residues left inside the oven.



For easier cleaning, remove the door.

Descaling



The presence of scale due to lack of descaling can compromise correct operation of the appliance in the long term.

The following indication will periodically appear on the appliance's display, notifying you that it is necessary to perform descaling of the evaporation tray on the base of the oven:

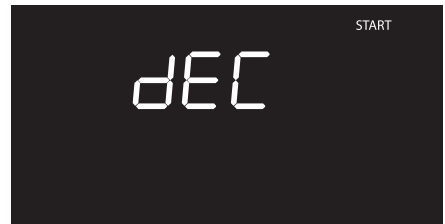

1. Open the door completely.
2. Pour approximately 250 ml of white vinegar into the evaporation tray, thus also covering part of the base of the oven.

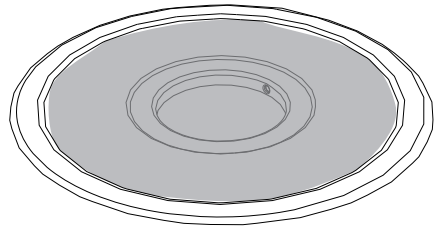



Cleaning and maintenance

3. Press the function knob to start the descaling function.



4. At the end of the descaling process, remove the vinegar from the base of the oven with the supplied sponge.
5. Use a dish sponge on softened encrustations in order to remove the largest possible quantity of scale.
6. When you have finished cleaning, close the door again.

Manual descaling

When you wish to perform descaling in advance, you can run the function manually:

1. Press and turn the function knob to select the descaling function.

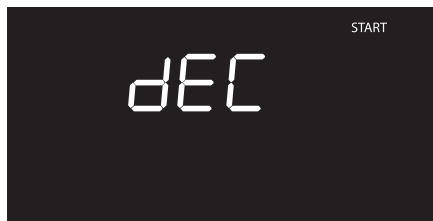

2. Proceed with the procedure described in the "Descaling" chapter, beginning at point 1.



We recommend performing descaling every time this is indicated on the display in order to keep the boiler in perfect operating condition.



If you wish to skip the descaling process, hold down the function knob for a few seconds.



Note: The descaling process can be skipped three consecutive times. After this, the appliance will not allow you to run any other function until the descaling process is performed.



Removing the rack/tray support frames

Removing the guide frames enables the sides to be cleaned more easily.

To remove the guide frames:

1. Unscrew the frame fastening pins.

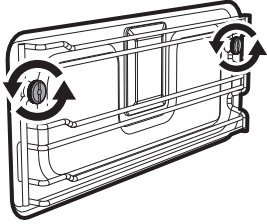

2. Pull the frame towards the inside of the oven to free it from the fastening pins.

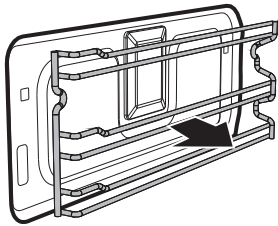

3. When cleaning is complete, repeat the above procedures to put the guide frames back in.

4.9 Cleaning the tank



To guarantee optimum performance of your appliance, we recommend cleaning the tank every 2-3 months.

1. Press and turn the function knob to select the **CLEAN** function.



2. Press the function knob to confirm your choice of function. The display will show a request to fill the tank.



3. Fill a container (e.g. a jug) with a solution of water and citric acid.



We recommend mixing 30 g of citric acid with 1.5 litres of water.



Cleaning and maintenance

4. Open the oven door.
5. Rest the container on the open door.

i Note: the container with the solution must have a gross weight lower than 5 kg.

6. Extract the tube from its seat and immerse its end in the container until it reaches all the way to the bottom.

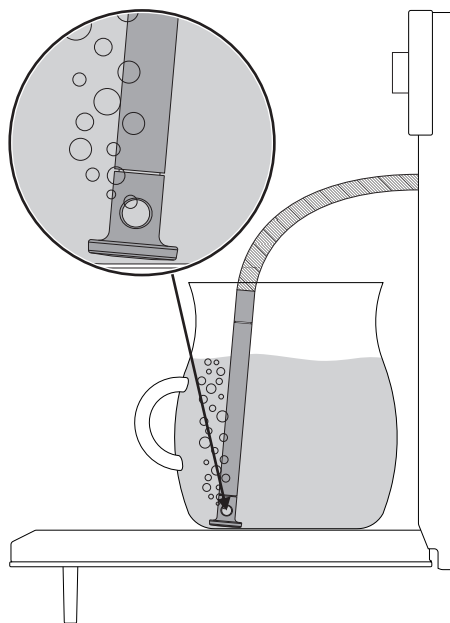

7. Press the function knob to start drawing the solution into the appliance's tank.

i The appliance will automatically draw sufficient solution to fill the tank.

8. When the appliance has finished taking in water, shake the tube to remove any residual water.

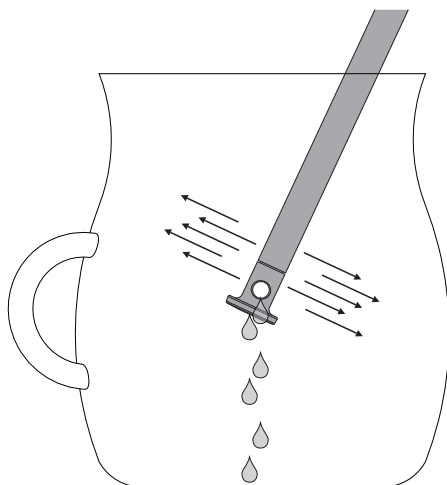

9. Return the tube to its original position, remove the container of solution and close the door.

i When the door is closed, an automatic system will automatically draw in any residual solution in the tube to avoid drips.

10. Press the function knob to start the tank cleaning process. The display will show the time left until the end of the cleaning cycle.



When the cleaning process is complete, a buzzer will sound and the display will show the solution draining screen.



1. Remove the cover from the evaporation tray and dry it with the sponge supplied.

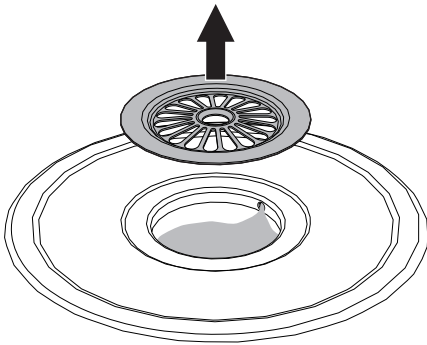

12. We recommend inserting the supplied sponge into the evaporation tray.
13. Press the function knob to begin draining the residual solution from the tank.

The residual solution is discharged into the evaporation tray.

Being the remaining quantity of solution over 500 ml, the solution will be discharged into the evaporation tray in two different steps to facilitate drying. The display will show "STEP 1" when the first stage has finished, and draining will stop. You must press the function knob again to complete the draining with "STEP 2". When this has completed, "END" will be displayed.

14. Use the supplied sponge to remove the residual solution from the evaporation tray.



After cleaning the tank with the water and citric acid solution, perform at least one more **CLEAN** cycle with clean water in order to rinse any impurities from the tank.



Cleaning and maintenance

4.10 Vapour Clean



Vapour Clean is an assisted cleaning procedure which facilitates the removal of dirt. Thanks to this process, it is possible to clean the inside of the oven very easily. The dirt residues are softened by the heat and water vapour for easier removal at a later stage.



Improper use
Risk of damage to surfaces

- Remove any food residues or large spills from previous cooking operations from the inside of the oven.
- Carry out assisted oven cleaning operations only when the oven is cold.

- Spray a water and washing up liquid solution inside the oven using a spray nozzle. Direct the spray against the side walls, upwards, downwards and towards the deflector.

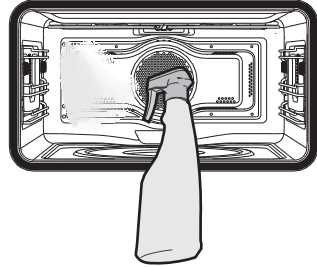

- Close the door.



We recommend spraying approx. 20 times at the most.

Preliminary operations

Before starting the Vapour Clean function:

- Completely remove all accessories from inside the oven.
- Pour approx. 40 cc of water onto the floor of the oven cavity. Make sure it does not overflow out of the cavity.

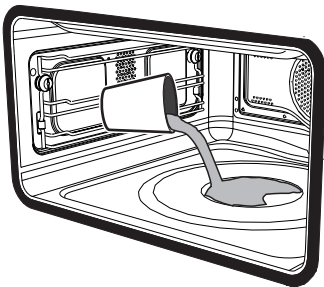



Vapour Clean setting

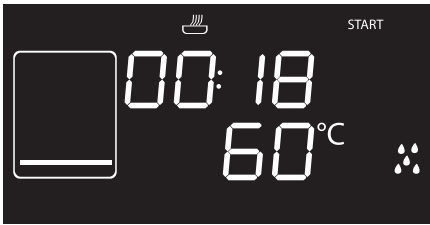

i If the internal temperature is greater than that required for the Vapour clean function, the cycle will be stopped immediately and STOP will appear on the display. Let the appliance cool down before activating the assisted cleaning cycle.

1. Press the function knob to activate the appliance.
2. Turn the function knob to the right or left to select the Vapour Clean function .
3. The duration and temperature of the cleaning cycle will appear on the display.
4. Press the temperature knob to start the Vapour Clean cleaning cycle.
5. A buzzer will indicate the end of the Vapour Clean cycle.

i The temperature and time parameters cannot be modified by the user.

End of the Vapour Clean cycle

1. Open the door and wipe away the less stubborn dirt with a microfibre cloth.
2. Use an anti-scratch sponge with brass filaments on tougher encrustations.
3. In case of grease residues use specific oven cleaning products.
4. Remove the water left inside the oven.
5. For improved hygiene and to avoid food being affected by any unpleasant odours, we recommend that the oven is dried using a fan assisted function at 160°C for approximately 10 minutes.



We recommend wearing rubber gloves for these operations.



For easier manual cleaning of the parts difficult to reach, we recommend removing the door.



Cleaning and maintenance

4.11 Extraordinary maintenance



Live parts
Danger of electrocution

- Unplug the appliance.

Replacing the internal light bulb

1. Completely remove all accessories from inside the oven.
2. Remove the rack/tray support frames.
3. Remove the bulb cover using a tool (e.g. a screwdriver).



Pay attention not to scratch the oven cavity enamel.

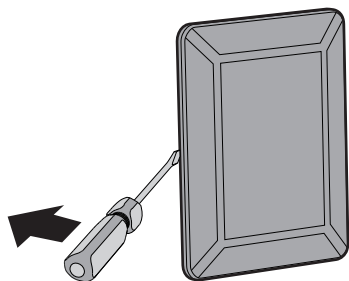

4. Slide out and remove the light bulb.

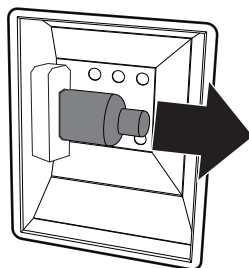

Do not touch the halogen light bulb directly with your fingers, but wrap it in insulating material.

5. Replace the light bulb with one of the same type (40W).
6. Refit the cover. Ensure the moulded part of the glass (**A**) is facing the door.

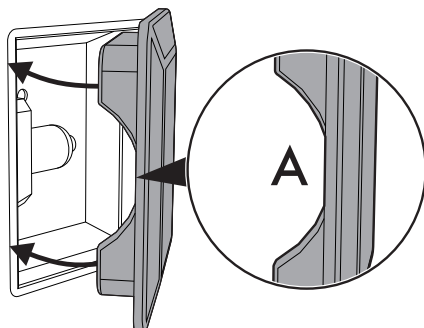

7. Press the cover completely down so that it attaches perfectly to the bulb support.



What to do if...

The display is completely off:

- Check the mains power supply.
- Check whether an omnipolar switch upstream of the appliance supply line is in the "ON" position.

The appliance does not heat up:

- Check whether it has been set in "showroom" mode (for further details see "Secondary menu").

The controls do not respond:

- Check whether it has been set in "child lock" mode (for further details see "Secondary menu").



If the problem has not been resolved or in the case of other types of fault, contact your local technical support centre.



If other ERRx error messages are indicated:
note down the error message, function and set temperature and contact your local technical support centre.



Installation

5 Installation

5.1 Electrical connection



**Power voltage
Danger of electrocution**

- Have the electrical connection performed by authorised persons.
- The appliance must be connected to earth in compliance with electrical system safety standards.
- Disconnect the mains supply.

General information

Check the grid characteristics against the data indicated on the plate.

The identification plate bearing the technical data, serial number and brand name is visibly positioned on the appliance.

Do not remove this plate for any reason.

The appliance works at 220-240 V~.

Use a three-pole cable (3 x 1.5 mm², referring to the cross section of the internal conductor).

Perform the ground connection using a wire that is 20 mm longer than the other wires.

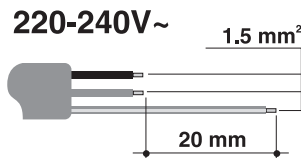

Fixed connection

Fit the power line with an omnipolar circuit breaker in compliance with installation regulations.

The omnipolar circuit breaker should be located near the appliance and in an easily reachable position, according to applicable electrical codes.

Connection with plug and socket

Make sure that the plug and socket are of the same type.

Avoid using adapters and shunts as these could cause overheating and a risk of burns.

5.2 Cable replacement



**Power voltage
Danger of electrocution**

- Disconnect the mains supply.
1. Unscrew the rear casing screws and remove the casing to access the terminal board.
 2. Replace the cable.
 3. Make sure that the cables (for the oven or any hob) follow the best route in order to avoid any contact with the appliance.



5.3 Positioning



Heavy appliance
Crushing hazard

- Position the appliance into the cabinet cutout with the help of a second person.



Pressure on the open door
Risk of damage to the appliance

- Never use the oven door to lever the appliance into place when fitting.
- Avoid exerting too much pressure on the oven door when open.



Heat production during appliance operation
Risk of fire

- Check that the piece of furniture material is heat resistant.
- Check that the piece of furniture has the required slots.
- Do not install the appliance in a recess which can be closed with a door, or in a cupboard.

Position of the power cable

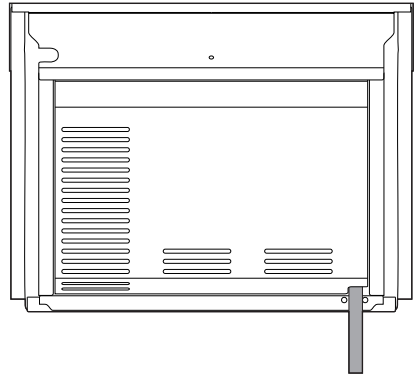

(rear view)

Front panel seal

Glue the supplied front panel seal to the lower part of the front panel to avoid water or other liquids from leaking in.

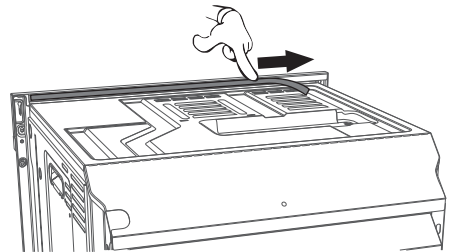



Installation

Fastening bushings

Remove the bushing covers inserted on the oven front.

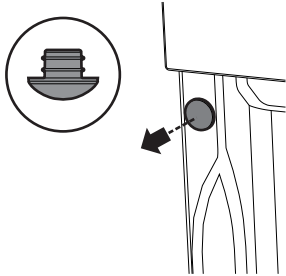

Mount the appliance into the recess.
Secure the appliance to the piece of furniture using screws.

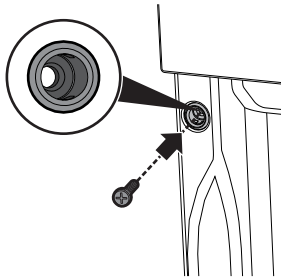

Cover the bushings with the covers removed previously.

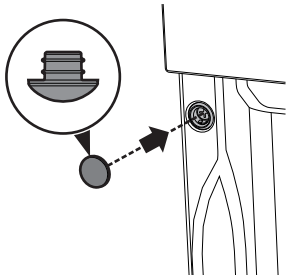

Appliance overall dimensions (mm)

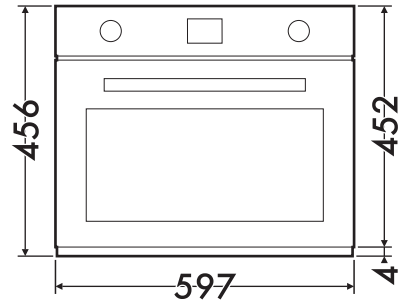

(front view)

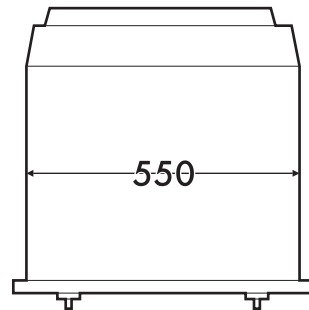

(top view)



Mounting under worktops (mm)

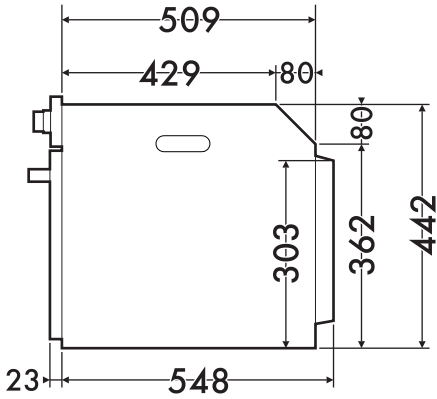

(side view)

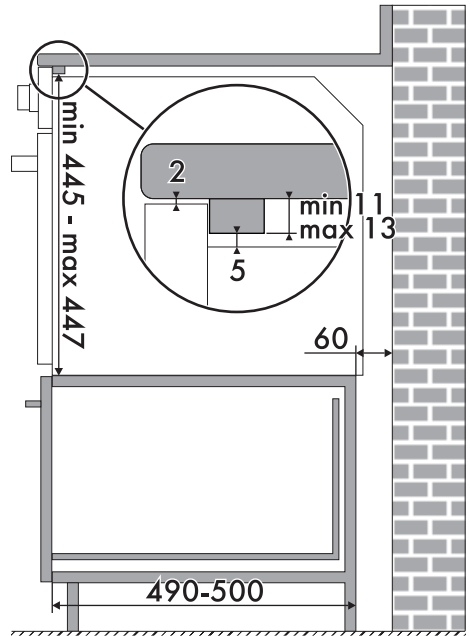
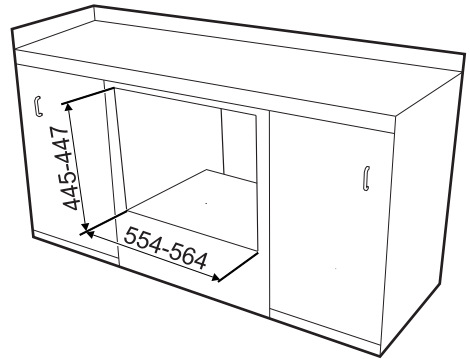
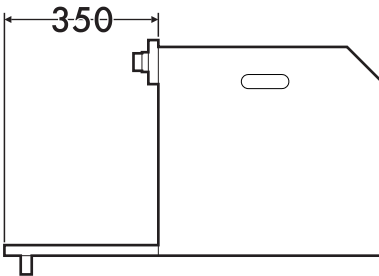
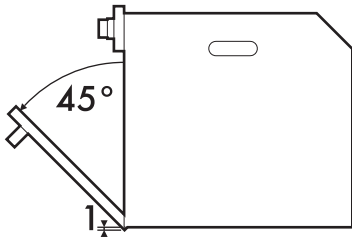

Make sure that the piece of furniture rear/bottom part has an opening of approx. 60 mm.



Installation

Mounting into a column (mm)

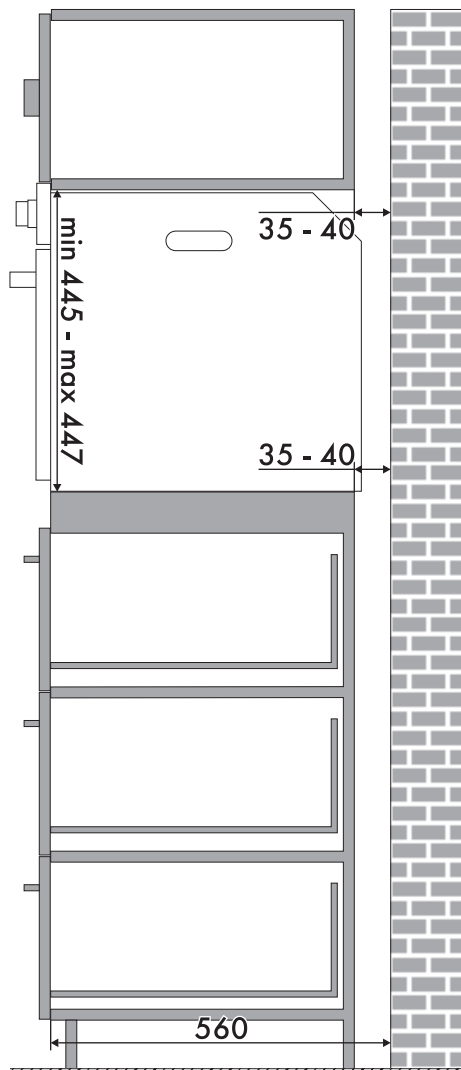
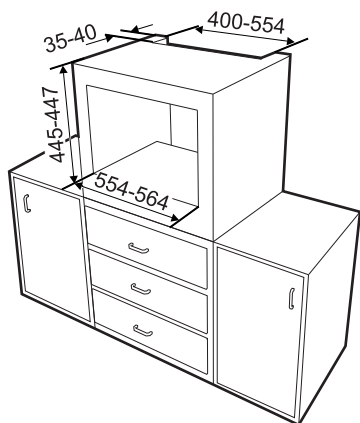

Make sure that the piece of furniture top/rear part has an opening approx. 35-40 mm deep.



914776380/B