



V-SERIES HEAVY DUTY BROILERS, DOUBLE DECK AND RANGE MATCH MODELS

For a complete listing of models, see the MODELS section.

- NOTICE -

This Manual is prepared for the use of trained Vulcan Service Technicians and should not be used by those not properly qualified.

This manual is not intended to be all encompassing. If you have not attended a Vulcan Service School for this product, you should read, in its entirety, the repair procedure you wish to perform to determine if you have the necessary tools, instruments and skills required to perform the procedure. Procedures for which you do not have the necessary tools, instruments and skills should be performed by a trained Vulcan Service Technician.

The reproduction, transfer, sale or other use of this Manual, without the express written consent of Vulcan, is prohibited.

This manual has been provided to you by ITW Food Equipment Group LLC ("ITW FEG") without charge and remains the property of ITW FEG, and by accepting this manual you agree that you will return it to ITW FEG promptly upon its request for such return at any time in the future.

TABLE OF CONTENTS

GENERAL	3
INTRODUCTION	3
MODELS	3
INSTALLATION, OPERATION AND MAINTENANCE	3
RACK POSITION AND GAS SETTING	3
SPECIFICATIONS	3
LUBRICATION	3
TOOLS	3
REMOVAL AND REPLACEMENT OF PARTS	5
MANIFOLD COVER	5
CONTROL VALVE COVER	5
CONTROL VALVE	5
PILOT TUBE (CERAMIC-RADIANT BURNER)	7
PILOT (INFRARED BURNER)	7
CERAMIC-RADIANT BURNER	8
INFRARED BURNER	10
GAS PRESSURE REGULATOR	10
RACK SPRINGS	10
SERVICE PROCEDURES AND ADJUSTMENTS	12
PILOT FLAME HEIGHT	12
CERAMIC-RADIANT BURNER AIR SHUTTER ADJUSTMENT	12
REGULATOR ADJUSTMENT	12
INFRARED BURNER ADJUSTMENT	13
INFRARED BURNER FLAME APPEARANCE	13
GAS ORIFICE CHECK	13
CONTROL VALVE	14
RACK SPRING TENSION ADJUSTMENT	14
TROUBLESHOOTING	15
GENERAL (ALL MODELS)	15
CERAMIC-RADIANT BURNER	15
INFRARED BURNER	16



GENERAL

INTRODUCTION

This manual is for the Vulcan V-Series Gas Broilers which include the double deck broiler models and the single broiler over the Heavy Duty Range (HDR) models. Procedures in this manual will apply to all models unless specified. Pictures and illustrations will be of model VIB2 - Infrared Broiler over Ceramic-Radiant Broiler unless otherwise noted.

All of the information, illustrations and specifications contained in this manual are based on the latest product information available at the time of printing.

MODELS

Range Match Broilers on Base (Ceramic-Radiant Burner)

- VBB1F - Modular (for refrigerated base mount only)
- VBB1BF - Cabinet Base
- VBB1SF - Standard Oven Base
- VBB1CF - Convection Oven Base

Range Match Broilers on Base (Infrared Burner)

- VIR1F - Modular (for refrigerated base mount only)
- VIR1BF - Cabinet Base
- VIR1SF - Standard Oven Base
- VIR1CF - Convection Oven Base

Double Deck Broilers

- VIR2 - Infrared Broiler over Infrared Broiler
- VBB2 - Ceramic-Radiant Broiler over Ceramic-Radiant Broiler
- VBI2 - Ceramic-Radiant Broiler over Infrared Broiler
- VIB2 - Infrared Broiler over Ceramic-Radiant Broiler

INSTALLATION, OPERATION AND MAINTENANCE

For detailed installation, operation and cleaning instructions, refer to F38215 V-Series Heavy Duty range (HDR) Broilers Operations Manual sent with each unit. The manual is also available online at www.vulcanequipment.com.

RACK POSITION AND GAS SETTING

NOTE: Infrared burner models must use the full gas setting (knob fully counterclockwise) to achieve the best burner performance and highest broiler temperatures. Lower broiler temperatures can be achieved by using a lower gas setting (knob in the range just past off but less than fully counterclockwise). When using a lower gas setting, the flame should remain lit and be steady across the entire burner surface.

For information on rack position and gas setting, refer to F38215 V-Series Heavy Duty range (HDR) Broilers Operations manual sent with each unit. The manual is also available online at www.vulcanequipment.com.

SPECIFICATIONS

GAS PRESSURES

- **Manifold/Operating Pressure**
 - Natural - 6" W.C.
 - Propane - 10" W.C.
- **Inlet Supply Pressure**
 - Natural - Recommended 7" - 9" W.C. with a minimum of 7" W.C.
 - Propane - Recommended 11" - 12" W.C. with a minimum of 11" W.C.
 - Maximum 14" W.C. (0.5 PSI) for Natural or Propane.

LUBRICATION

Anderson and Forrester (or comparable) valve grease for burner valve stems. Apply light coat to valve stems. Valve grease must be insoluble in propane and natural gas.

TOOLS

Standard

- Standard set of hand tools.
- Manometer.
- Gas leak detection equipment.
- Pipe thread sealant. Any sealant used must be resistant to the reaction of propane gases.

Special

- Pipe tee for checking gas manifold pressure after the regulator when a pressure tap is not available in the gas manifold (purchase parts locally). Assemble the parts and retain for future use on gas equipment:
 - Pipe tee sized for the gas line inlet connection and pipe fittings (pipe nipples, reducers etc.) for the connection as required.
 - Hose barb to install in the tee for connecting manometer hose.

REMOVAL AND REPLACEMENT OF PARTS

MANIFOLD COVER

1. Remove screws that secure manifold cover and remove the cover from broiler.
2. Reverse procedure to install.



Fig. 1

CONTROL VALVE COVER

⚠ WARNING Shut off the gas before servicing the unit.

⚠ WARNING All gas joints disturbed during servicing must be checked for leaks. Check with a soap and water solution (bubbles). Do not use an open flame.

1. Remove MANIFOLD COVER.

NOTE: When servicing the upper broiler on a double deck unit, the manifold cover on the lower broiler must also be removed.

2. Loosen set screw and remove knob from control valve.

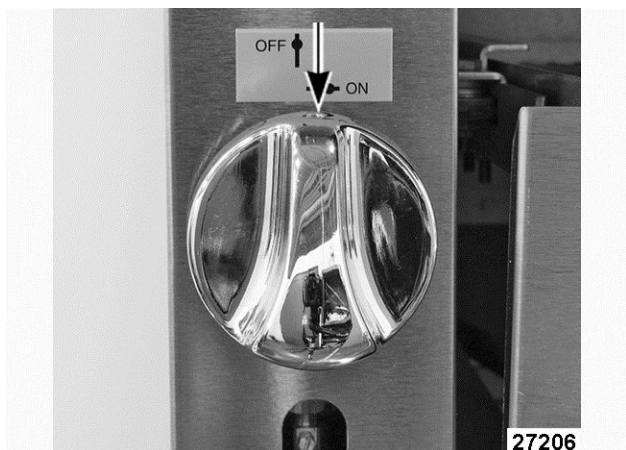

Fig. 2

3. Remove screws securing the control valve cover [1] to broiler.



Fig. 3

4. Reverse procedure to install.

CONTROL VALVE

⚠ WARNING Shut off the gas before servicing the unit.

⚠ WARNING All gas joints disturbed during servicing must be checked for leaks. Check with a soap and water solution (bubbles). Do not use an open flame.

Accessing Control Valve

- Upper Broiler (double stack or single unit over range) - The side panel must be removed as outlined in the procedure. The rear of panel is secured to the broiler frame with screws. The bottom lip of the panel and the top lip of the panel at the both corners are an interference fit.
- Lower Broiler (double stack or finishing oven on top) - The side panel can only be pulled away from broiler at the bottom of panel. The rear of panel is secured to broiler frame with screws. The bottom lip of the panel at the front and rear are an interference fit. The top lip of the panel is secured to the broiler frame with screws.

NOTE: When servicing the upper broiler on a double deck unit, the manifold cover on the lower broiler must also be removed.

1. Remove MANIFOLD COVER.
2. Remove CONTROL VALVE COVER.
3. Remove side panel (left or right):
 - A. Loosen several screws securing brace [1] Fig. 4 to broiler frame near the side panel to remove. The upper front right of the broiler is shown in Fig. 4.

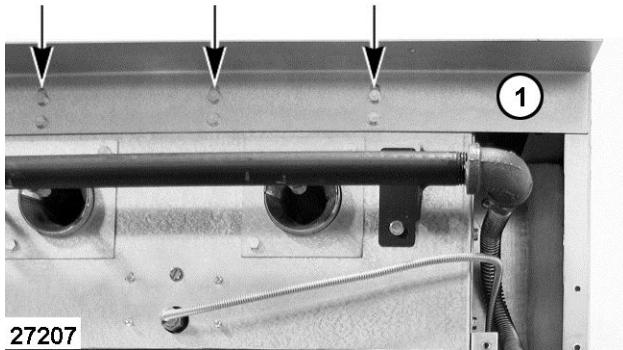

Fig. 4

- B. At rear of broiler, loosen screws securing the flue back panel [1] Fig. 5 to broiler frame then lift panel off broiler.

NOTE: The mounting holes in the flue back panel Fig. 5 are keyed to allow for easy panel removal without having to remove all the screws that are also securing the back panel Fig. 6 to broiler frame.

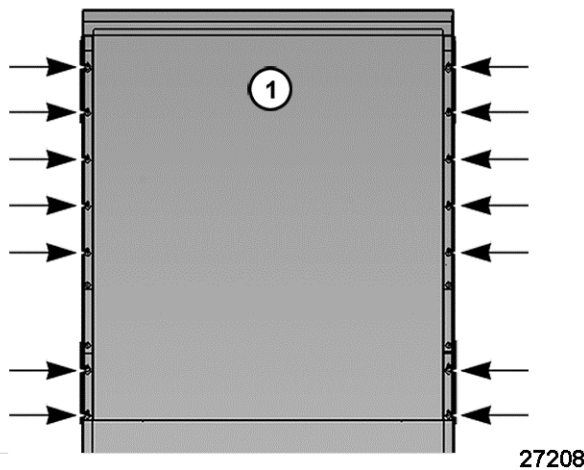

Fig. 5

- C. For the side panel being removed, remove screws at the rear that are securing the back panel [1] Fig. 6 and side panel to broiler frame. Arrows shown in Fig. 6 are pointing to the rear screw locations for right side panel removal.

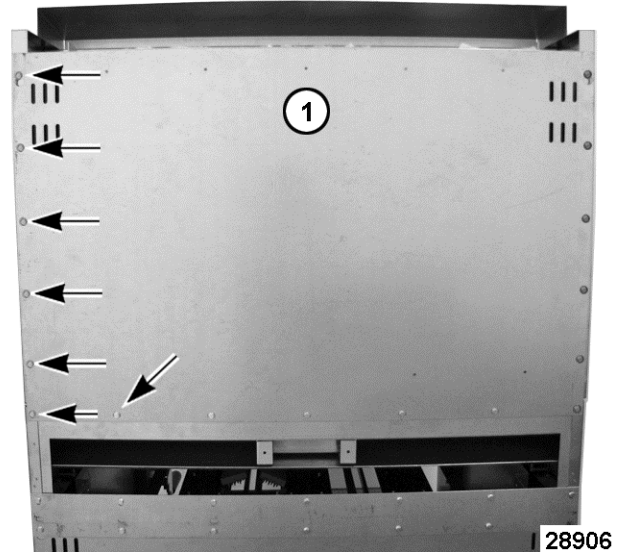

Fig. 6

- D. Remove side panel from broiler.
4. Disconnect compression nut [1] Fig. 7 above the control valve for the burner gas supply.
5. Disconnect flexible tubing compression nut [2] Fig. 7 from the pilot valve adjustment fitting.
6. Separate union fitting [3] Fig. 7 at the bottom of control valve to remove the valve.

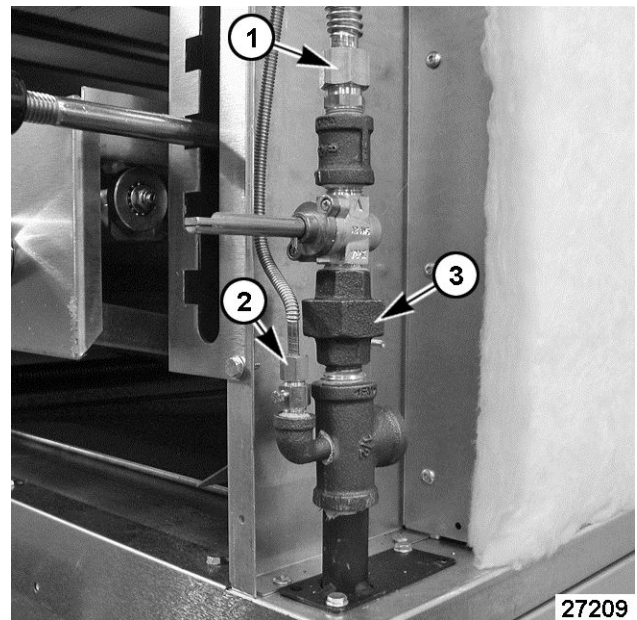

Fig. 7

7. Note locations then remove pipe fittings from control valve.

⚠ WARNING Clean pipe threads and apply thread sealant that is suitable for use with propane gases.

8. Install pipe fittings on replacement valve.

- Reverse procedure to install replacement valve.
- Check for proper operation.

PILOT TUBE (CERAMIC-RADIANT BURNER)

⚠ WARNING Shut off the gas before servicing the unit.

⚠ WARNING All gas joints disturbed during servicing must be checked for leaks. Check with a soap and water solution (bubbles). Do not use an open flame.

- Remove MANIFOLD COVER.
- Remove screws securing pilot tube mounting bracket to broiler.

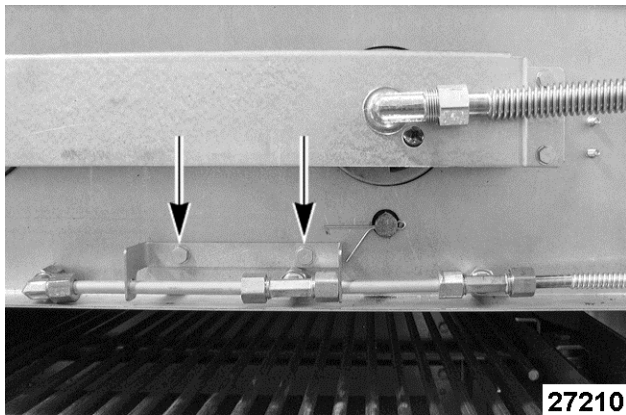

Fig. 8

- Pull the pilot tube assembly Fig. 9 away from broiler. There are 3 pilot tubes on each assembly.
- Disconnect compression nut Fig. 9 from the pilot tube fitting and remove the tube.

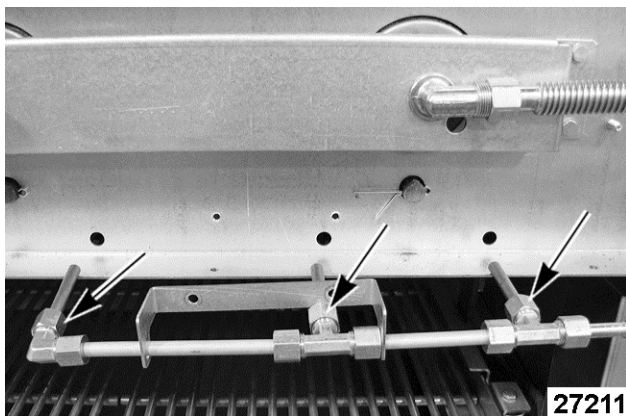

Fig. 9

NOTICE When disconnecting compression nut from the pilot tube fitting, support the fitting to prevent damage to pilot tubing.

- Reverse procedure to install and check for proper operation.

PILOT (INFRARED BURNER)

⚠ WARNING Shut off the gas before servicing the unit.

⚠ WARNING All gas joints disturbed during servicing must be checked for leaks. Check with a soap and water solution (bubbles). Do not use an open flame.

- Remove MANIFOLD COVER.
- Disconnect compression fitting [1] Fig. 10 for pilot gas tubing.
- Remove screw [2] Fig. 10 and lock washer nut [3] Fig. 11 securing pilot to mounting bracket.

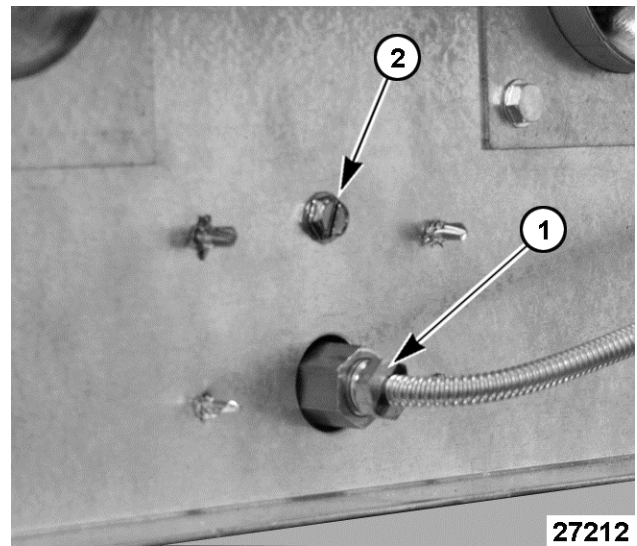

Fig. 10

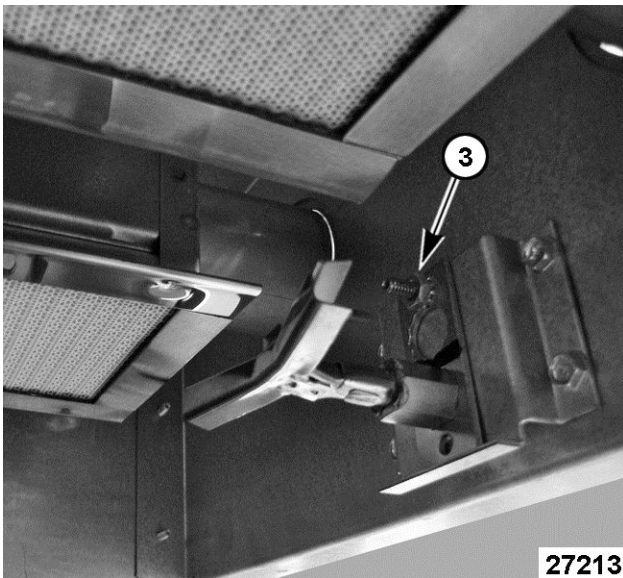

Fig. 11

- Reverse procedure to install and check for proper operation.

CERAMIC-RADIANT BURNER

⚠ WARNING Shut off the gas before servicing the unit.

- Remove MANIFOLD COVER.
- Remove CONTROL VALVE COVER next to rack lift assembly handle.
- Adjust rack assembly to the lowest position to access the burners.

NOTICE Ceramic bricks can easily be damaged. Use care when handling.

- Lift ceramic bricks [1] Fig. 12 off the support rails [2] Fig. 12 for each burner [3] Fig. 12. There are 6 ceramic bricks for each of the 3 burners (18 bricks total).

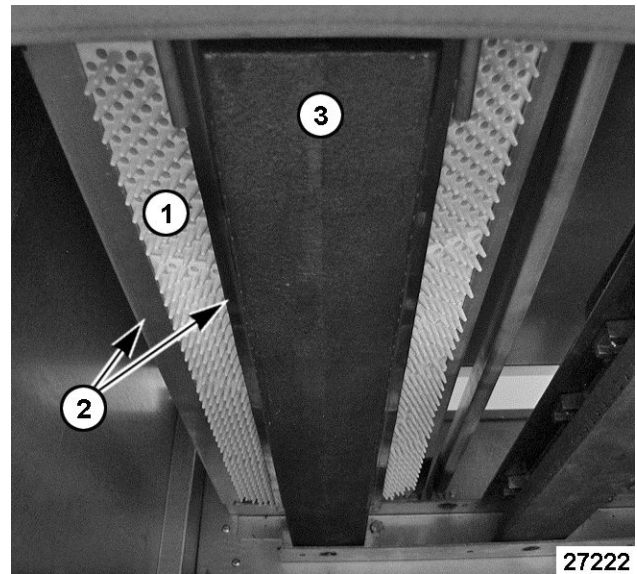

Fig. 12

- Remove screws securing pilot tube mounting brackets [1] Fig. 13 to burner support [2] Fig. 13. Position pilot tube assemblies out of the way to the sides.

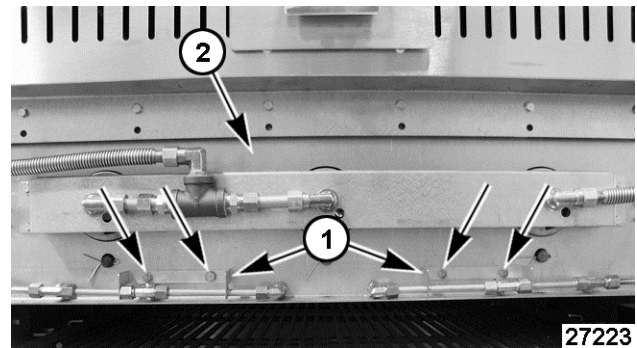

Fig. 13

- Remove screws securing manifold bracket [1] Fig. 14 to burner support [2] Fig. 14. Allow bracket to drop down out of the way.

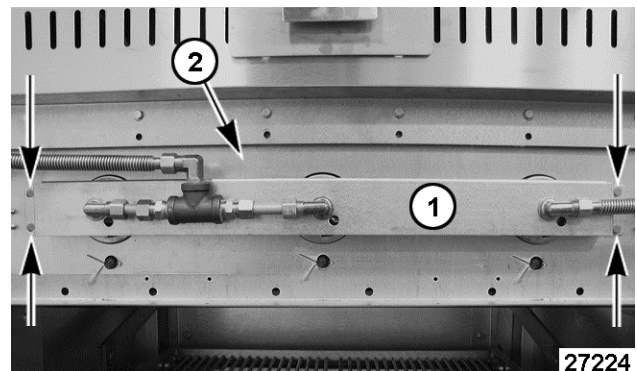

Fig. 14

- Loosen screws [1] Fig. 15 (qty 6) by several turns that secure the burner support [2] and brace [3] Fig. 15 to broiler frame.

NOTE: Leave the burner support screws installed. The burner support is necessary to hold the burners in place during removal procedure.

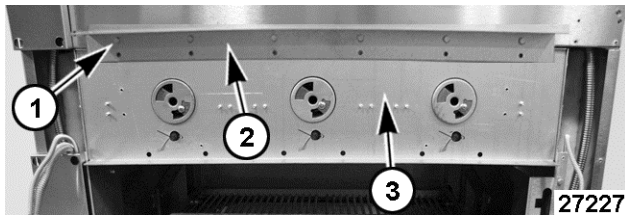

Fig. 15

8. Remove screws [1] Fig. 16 (qty 6) securing burner support [2] Fig. 16 to broiler frame.

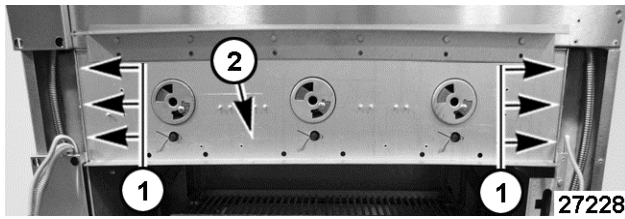

Fig. 16

9. Reach underneath burner support to access the support rails [1] Fig. 17 (qty 6) that hold the ceramic bricks in place. Remove screws (qty 2) Fig. 17 securing each support rail to the rear of burner support. Top view shown in Fig. 17.

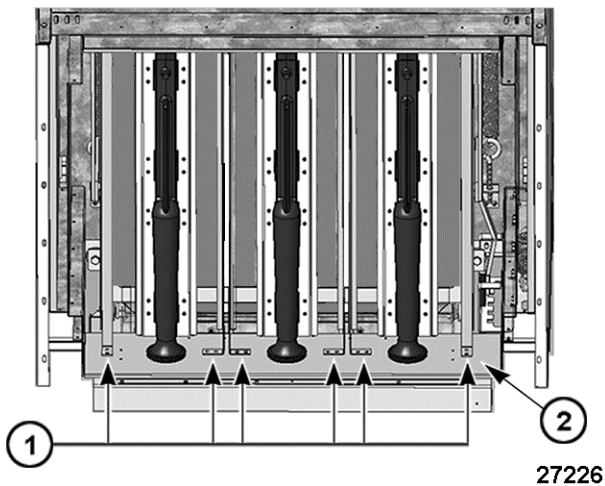

Fig. 17

10. Provide support for burners from inside the cooking area by stacking two 2 x 4's approximately 24" long onto the broiler grid. Position 2 x 4's underneath the burners near the front.

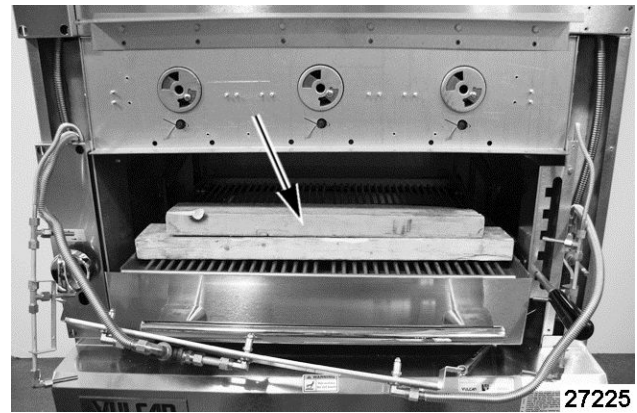

Fig. 18

11. Adjust rack assembly to the middle position.
12. Remove cotter pin from all three burners.

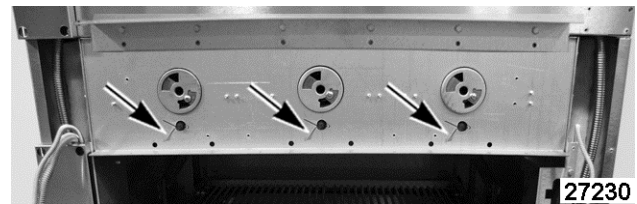

Fig. 19

13. Grasp the bottom of burner support in between the burners and pull out on the burner support to disengage burners. The front of burners will drop down onto the 2 x 4's. Ensure the burner air shutters are not catching in the burner support opening to prevent removal.

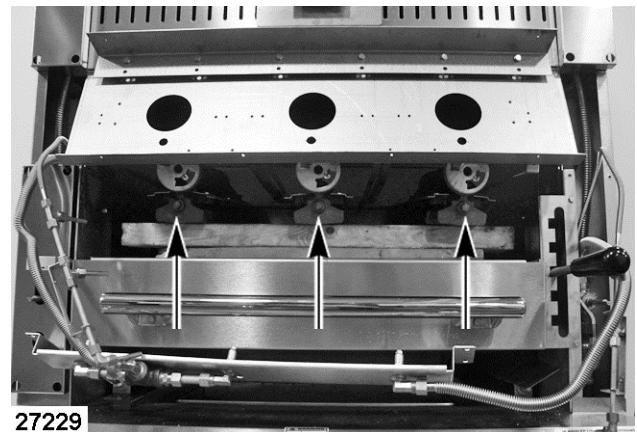

Fig. 20

14. Lift the burner being replaced off the rear pin and pull toward the front to remove from broiler.
15. Remove burner support rails [1] Fig. 21 from each side of burner [2] Fig. 21 being replaced.

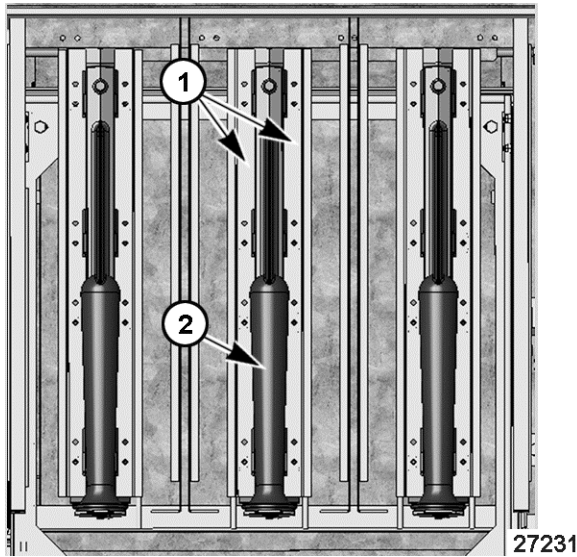

Fig. 21

16. Install burner support rails on replacement burner.
17. Reverse procedure to install.
18. Perform CERAMIC-RADIANT BURNER AIR SHUTTER ADJUSTMENT.

INFRARED BURNER

⚠ WARNING Shut off the gas before servicing the unit.

1. Remove MANIFOLD COVER.
2. Adjust rack assembly to the lowest position.
3. From inside the broiler cooking area, remove wire Fig. 22 securing burner to mounting bracket.

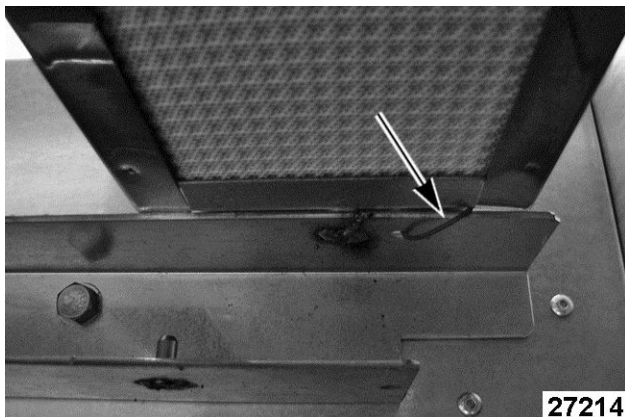

Fig. 22

4. Lift burner up at the rear and slide it away from gas orifice to remove from broiler.
5. Reverse procedure to install replacement burner.

NOTE: When installing, secure the burner with wire.

6. Check for proper operation.

GAS PRESSURE REGULATOR

⚠ WARNING Shut off the gas before servicing the unit.

⚠ WARNING All gas joints disturbed during servicing must be checked for leaks. Check with a soap and water solution (bubbles). Do not use an open flame.

⚠ WARNING Clean pipe threads and apply thread sealant that is suitable for use with propane gases.

NOTE: Gas pressure regulator should be installed as close to the broiler inlet gas connection as possible.

1. Thread regulator [1] Fig. 23 onto pipe hand tight with arrow on regulator pointing in direction of gas flow to the broiler.

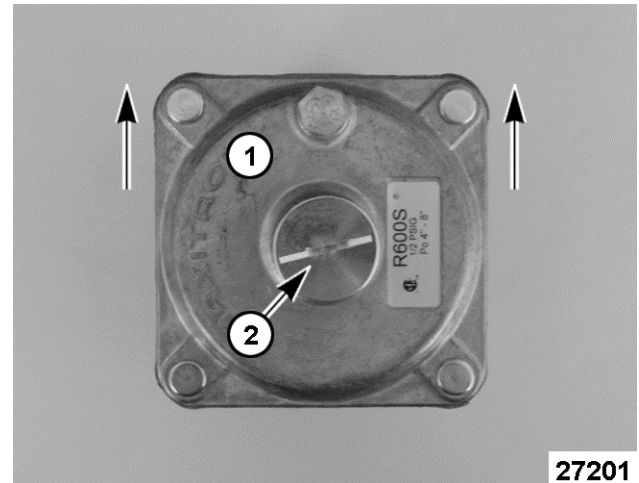

Fig. 23

2. Tighten regulator securely in horizontal position with the regulator adjustment upward [2] Fig. 23. Regulator adjustment is below the closing nut.

NOTE: Regulator will not function properly without adjustment screw pointing upward.

3. Connect main gas supply line to gas pressure regulator inlet.
4. Adjust regulator as outlined in REGULATOR ADJUSTMENT.

RACK SPRINGS

NOTE: Springs should be replaced in pairs for proper operation of the rack lift assembly.

1. Raise the rack lift assembly to its highest position on stop bracket to relieve spring tension.

2. Loosen spring tension adjusting nuts to remove any remaining tension on springs.



Fig. 24

3. Remove springs from the lifting arm mechanism and eye bolt.
4. Reverse procedure to install.
5. Perform RACK SPRING TENSION ADJUSTMENT.

SERVICE PROCEDURES AND ADJUSTMENTS

PILOT FLAME HEIGHT

1. Locate the pilot adjustment screws below the burner control knobs (one on each side) on the front of broiler. It is not necessary to remove the control valve cover as the adjustment access holes are provided in the panel.



Fig. 25

2. Locate the pilots at the top of the broiler heating area.
3. Monitor the pilots flame and burner lighting. Pilot is in adjustment when it will stay on continually and lights the burners without delayed ignition. Approximate pilot flame height:
 - A. Ceramic-Radiant Burner - 1/2" bubble extending from the end of pilot tube.
 - B. Infrared Burner - 3/4" from each side of the pilot tee.
4. If adjustment is necessary, rotate the screw clockwise to decrease and counterclockwise to increase flame height.

CERAMIC-RADIANT BURNER AIR SHUTTER ADJUSTMENT

The efficiency of the burner depends on a delicate balance between the air supply and volume of gas. Whenever this balance is disturbed, poor operating characteristics and excessive gas consumption may occur. An air shutter on the front of the burner controls the gas mixer balance. A yellow streaming flame on the burner is an indication of insufficient primary air.

To correct this condition, loosen the shutter screw Fig. 26 and rotate the air shutter Fig. 27 open until the flame begins to lift from the burner, then close the shutter slightly and tighten the shutter screw. A proper flame should be blue in color, well-defined and seated on the burner port. A white-blue flame is a result of excessive primary air.

NOTE: The factory default air shutter positions are half open natural; full open propane.

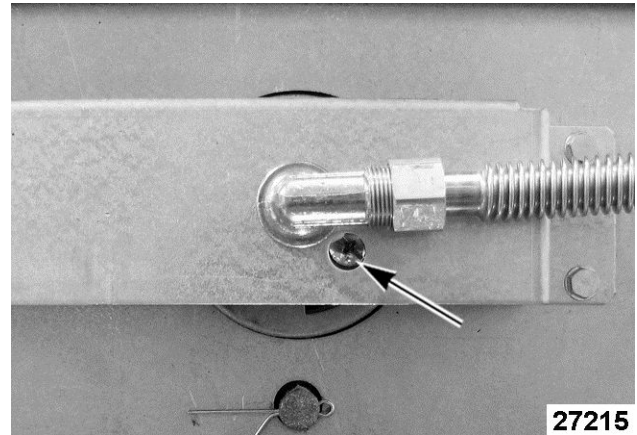

Fig. 26

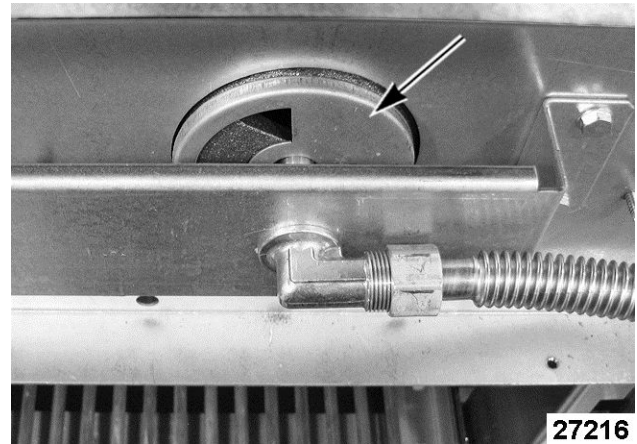

Fig. 27

REGULATOR ADJUSTMENT

⚠ WARNING Shut off the gas before servicing the unit.

NOTE: Regulators come preset, but should be checked anytime one is installed. Before adjusting regulator, check incoming gas line pressure. Incoming pressure must be 7-14" W.C. for natural gas and 11-14" W.C. for propane gas. If incoming pressure is not correct, have the gas source checked and adjusted as necessary. Make sure the regulator is

mounted in the horizontal position with the arrow pointing in the direction of gas flow. See [GAS PRESSURE REGULATOR](#) under REMOVAL AND REPLACEMENT OF PARTS.

See data plate for manifold pressure setting information. Clean vent cap [1] [Fig. 28](#) before adjusting.

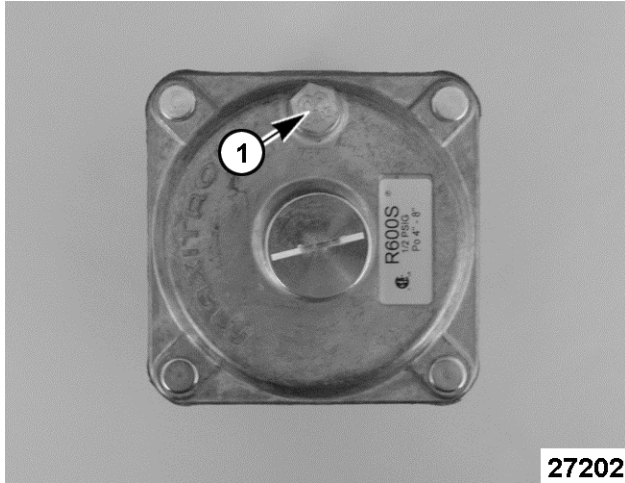

Fig. 28

1. Connect manometer to measure gas manifold pressure.
 - A. Install a tee with hose barb connection on the outlet side of the regulator. See [TOOLS](#). Connect the opposite end of tee to the incoming gas supply for the machine.
2. Turn gas supply on and light all pilots on the machine.
3. Open all valves to the full on position to light burners and check manometer reading. The reading should be 6" W.C. for natural gas and 10" W.C. for propane gas. Tolerance is ± 0.3 " W.C.
4. If manifold pressure is not correct, adjust the regulator as follows.
 - A. Remove the regulator closing nut [1] [Fig. 29](#).

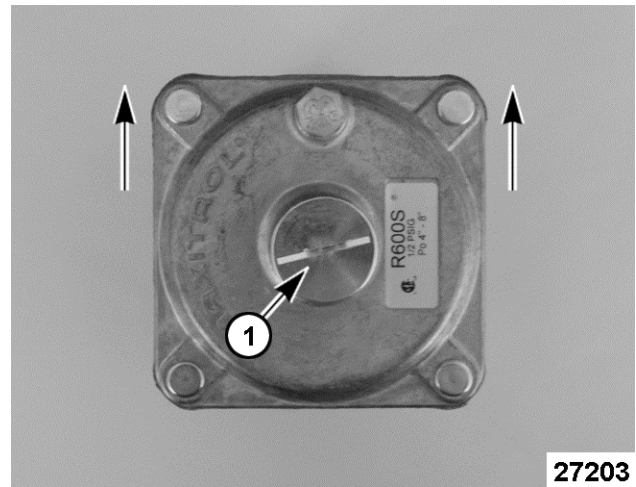

Fig. 29

- B. Insert a flat edge screwdriver through the top of the regulator. While watching the manometer, turn the adjusting screw clockwise to increase pressure and counterclockwise to decrease pressure until the proper gas pressure is achieved.
- C. Install the regulator closing nut.
- D. Turn gas supply off.
- E. Remove manometer and tee from gas line.

⚠ WARNING Clean pipe threads and apply thread sealant that is suitable for use with propane gases.

- F. Apply thread sealant to gas line pipe threads and re-install regulator.

INFRARED BURNER ADJUSTMENT

The only adjustment for the Infrared burner is the gas manifold pressure. Verify the pressure is set correctly as outlined under [REGULATOR ADJUSTMENT](#).

INFRARED BURNER FLAME APPEARANCE

When the Infrared burner first lights you should see a small rolling blue flame, which will clear up after the burner warms. Once warm, a low profile orange flame is the best description of the Infrared burner flame. In some cases, if the burner is operating correctly, you may not be able to see the actual flame. Instead you will see the glow of the ceramic bricks in the burner.

GAS ORIFICE CHECK

If burner operation seems poor and other systems have been checked, remove [MANIFOLD COVER](#) to access the gas and air inlet for the Ceramic-Radiant

burner Fig. 30 or Infrared burner Fig. 31. Inspect the following:

- Gas orifice alignment - orifice should be centered in the venturi opening and perpendicular to the burner.
- Check gas orifice for blockage or damage. If dirty, clean with air or water only.
- Verify gas orifice is correct for the altitude.

Ceramic-Radiant Burner Orifice



Fig. 30

Infrared Burner Orifice

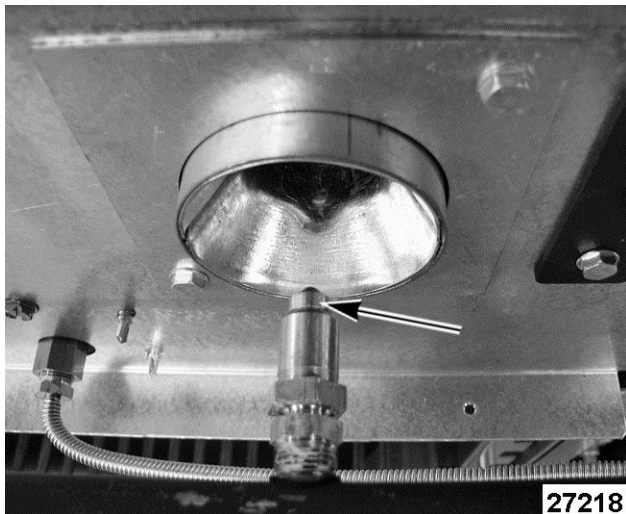

Fig. 31

CONTROL VALVE

⚠ WARNING Shut off the gas before servicing the unit.

Inspect the control valve for smooth rotation, noticeable wear and any possible damage. The burner flame should increase smoothly as the valve is opened (highest setting) and decrease smoothly as

the valve is being closed. When inspecting valve, always apply a light amount of valve grease at the base of the valve stem. See LUBRICATION. If valve grease does not improve rotation of the valve, or damage is found, replace the CONTROL VALVE as outlined under REMOVAL AND REPLACEMENT OF PARTS.

RACK SPRING TENSION ADJUSTMENT

1. Raise the rack lift assembly to its highest position on stop bracket to relieve spring tension.
2. Access spring tension adjusting nuts from the front of broiler.



Fig. 32

3. Tighten nut [1] to adjust rack spring tension. Adjust both springs equally so there is approximately 5/8" of thread above the nut. Spring tension is properly adjusted when the rack assembly can be comfortably raised and lowered by the operator using one hand.

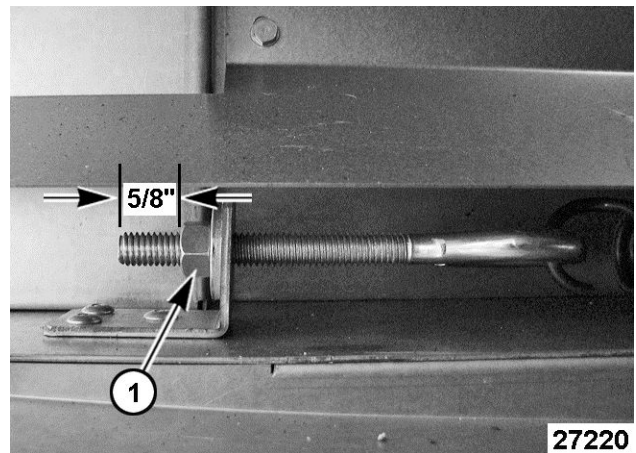

Fig. 33

4. If additional rack spring tension is required, tighten each nut an additional 2-3 turns and re-check.
5. Check for proper operation.



TROUBLESHOOTING

GENERAL (ALL MODELS)

GENERAL	
SYMPTOM	POSSIBLE CAUSE
Pilot does not remain lit.	<ol style="list-style-type: none"> 1. Incorrect gas type. 2. Incorrect gas pressure. 3. Pilot burner not adjusted properly. 4. Pilot burner blocked or Incorrect pilot orifice.
Slow to heat or not hot enough.	<ol style="list-style-type: none"> 1. Incorrect gas type. 2. Low gas pressure. 3. Regulator adjustment or malfunction. 4. Control valve malfunction.
Broiler temperature too hot.	<ol style="list-style-type: none"> 1. Incorrect gas type. 2. Regulator adjustment or malfunction due to high gas pressure. 3. Control valve malfunction.

CERAMIC-RADIANT BURNER

CERAMIC-RADIANT BURNER	
SYMPTOM	POSSIBLE CAUSE
Flame too yellow.	<ol style="list-style-type: none"> 1. Orifice incorrect size or dirty. 2. Air shutter not adjusted correctly or dirty. 3. Incorrect gas pressure. 4. Incorrect gas type. 5. Orifice not aligned properly in venturi. 6. Appliance not venting properly.
Low burner flame (all burners).	<ol style="list-style-type: none"> 1. Regulator adjustment or low gas pressure. 2. Incorrect gas type.
Low burner flame (individual burner).	<ol style="list-style-type: none"> 1. Air mixture incorrect.
Flame floats on burner.	<ol style="list-style-type: none"> 1. Inadequate air supply. 2. Restricted exhaust flue.

INFRARED BURNER

NOTE: Grease laden air is detrimental to the life of the Infrared burner. If a technician sees a broiler with Infrared burner mounted in a location close to a fryer or charbroiler, please recommend to the customer to move the broiler away from the grease laden air source to prolong the life of the Infrared burner.

INFRARED BURNER	
SYMPTOM	POSSIBLE CAUSE
Flame not orange.	<ol style="list-style-type: none"> 1. Orifice incorrect size or dirty. 2. Incorrect gas pressure. 3. Incorrect gas type. 4. Orifice not aligned properly in venturi. 5. Appliance not venting properly. 6. Clogged burner ports. 7. Burner malfunction.
Burner not lighting properly or incorrect burner flame appearance due to clogged ports.	<ol style="list-style-type: none"> 1. Broiler with Infrared burner is located too close to a fryer or charbroiler and the grease laden air is causing burner ports to clog. If burner ports are found to be clogged, install a replacement burner. See <u>NOTE</u> at top of page.
Tiles falling out of the burner.	<ol style="list-style-type: none"> 1. Burner ports are clogged from the broiler operating too close to a fryer or charbroiler that is creating grease laden air. Clogged burner ports create poor burner performance and cause the burner housing to overheat and warp allowing the tiles to fall out of burner. If tiles are missing, install a replacement burner. See <u>NOTE</u> at top of page.

