

# rocking chair

Product ID. 7A2YN

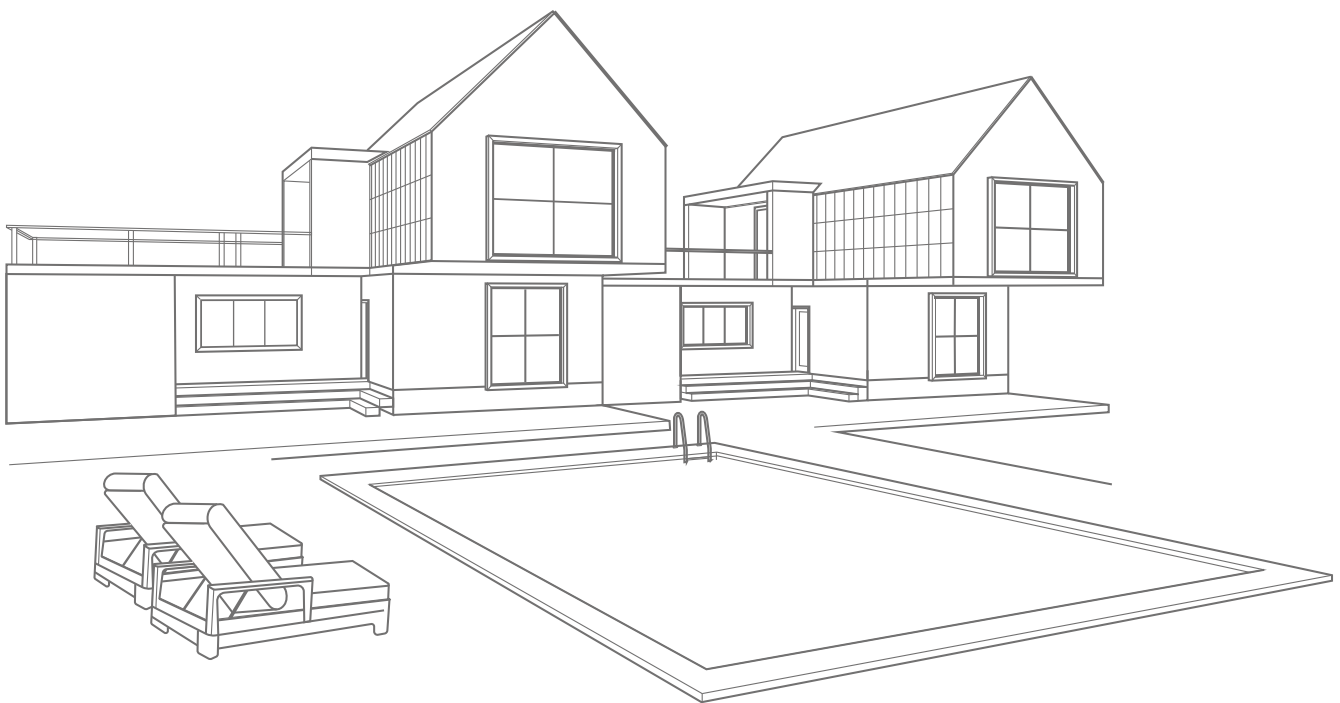

Scan for Support



Distributed by  
**GARVEE**.com

support@garvee.com

Support Email: [support@garvee.com](mailto:support@garvee.com)  
Customer Phone Service: +1 888 891 2855  
Mon - Fri from 9AM to 5PM (PST)

# ROCKING CHAIR

## ASSEMBLY INSTRUCTIONS



**It is recommended that 2 people install the product.**

**Thank you for choosing our outdoor furniture! To ensure your safety and a positive user experience, please carefully read the following safety statement:**

**1.Pre-Use Inspection:** Before using the outdoor furniture, please inspect all components to ensure there are no damages, missing parts, or improper installation. If any issues are found, do not use the product and contact us immediately.

**2.Weight Limit:** Please adhere to the weight limits provided by the manufacturer. Exceeding the weight limit may cause damage to the furniture or lead to tipping, resulting in injury.

**3.Stable Placement:** Ensure that the furniture are used on a flat and sturdy surface to prevent collapse or sliding due to unevenness or instability.

**4.Extreme Weather:** In extreme weather conditions such as strong winds, heavy rain, or snow, please store the outdoor furniture indoors to prevent damage or accidents.

**5.Designed for Outdoor Use:** This product is designed for outdoor use, but care should be taken to avoid contact with sharp objects that could scratch or damage the surface.

**6.Regular Maintenance:** Regularly check the condition of the furniture, including connection points and stability. If any parts are loose or damaged, please repair or replace them promptly.









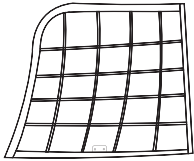

**7.Safe Use:** Please exercise caution while using the furniture. Avoid jumping or rocking vigorously, as this could result in accidental injury.

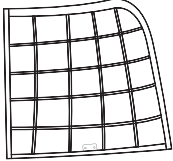
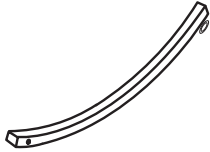
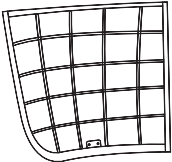
**8.Child Safety:** When children are using the furniture, please supervise them at all times to ensure they use the product correctly and safely.

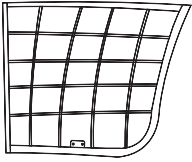
**Disclaimer:** By using this product, you acknowledge that you have read, understood, and agreed to adhere to this safety statement. The manufacturer or supplier shall not be liable for any loss or injury resulting from failure to comply with this safety statement.

**If you have any questions or need further assistance, please feel free to contact us.**

**Thank you for your understanding and support, and we wish you a pleasant experience!**

Item no.	Reference Image	Qty.	Item no.	Reference Image	Qty.
<b>A</b>		X1	<b>F</b>	 M6*60mm	X4
<b>A1</b>		X1	<b>G</b>		X2
<b>B</b>		X1	<b>H</b>		X1
<b>B1</b>		X1	<b>I</b>	 M6*35mm	X12
<b>C</b>		X1	<b>J</b>		X1
<b>D</b>		X1	<b>K</b>		X1
<b>E</b>	 M6*15mm	X8			

# 1

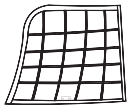

(A) 1pc

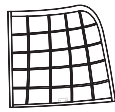

(A1) 1pc



M6\*35mm

(I) 3pcs

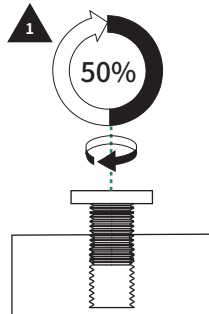
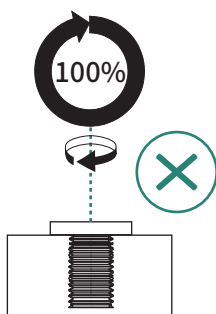
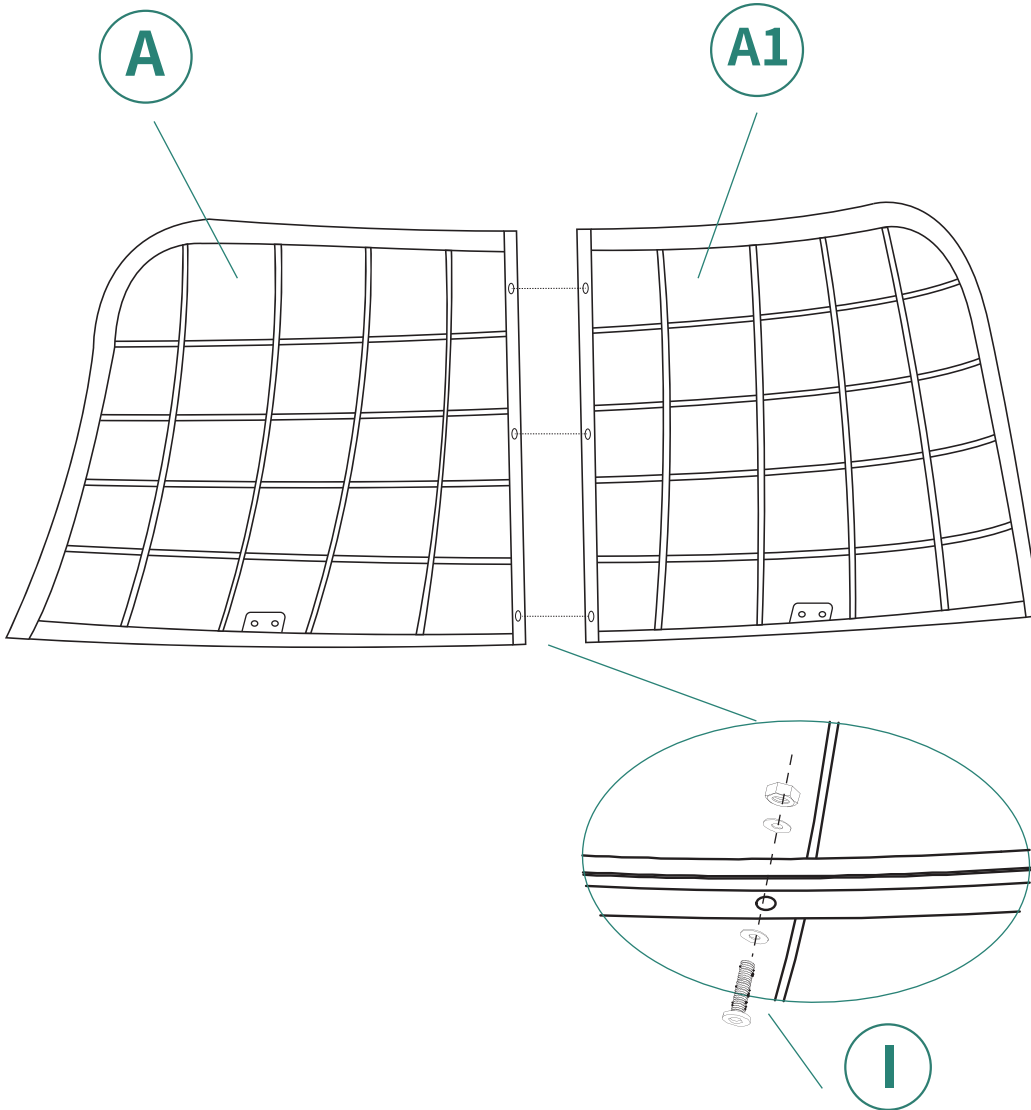

1. First, partially tighten all the screws to about 50% of the full torque, do not fully tighten them.

# 2

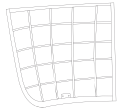

Ⓑ 1pc

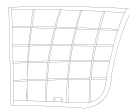

Ⓑ1 1pc



M6\*35mm

ⓘ 3pcs

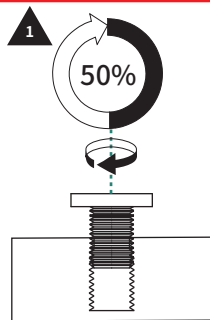
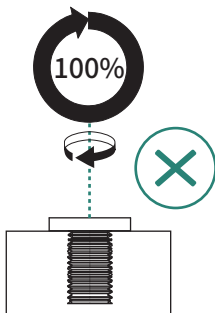
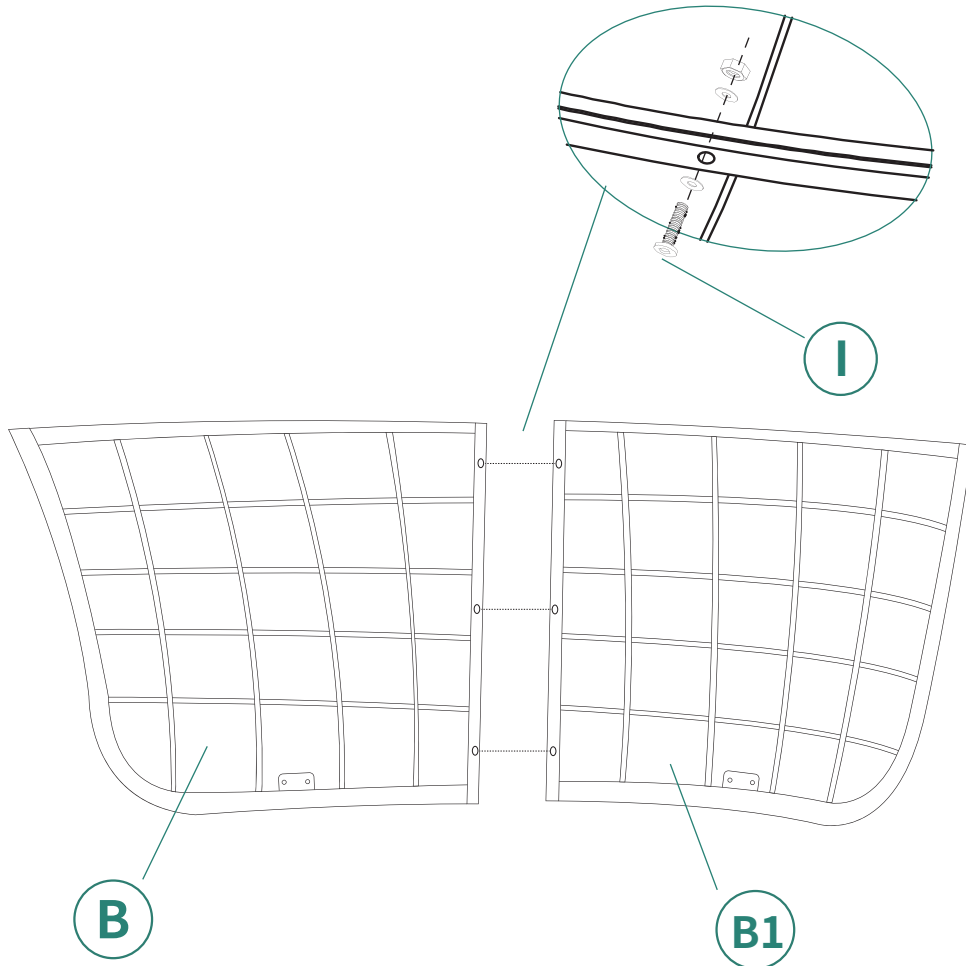

1. First, partially tighten all the screws to about 50% of the full torque, do not fully tighten them.

# 3

M6\*35mm  
① 6pcs

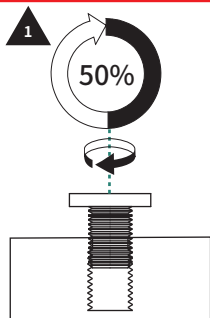
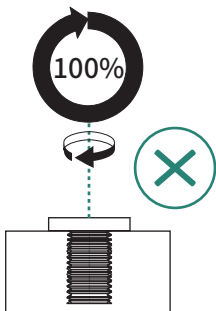
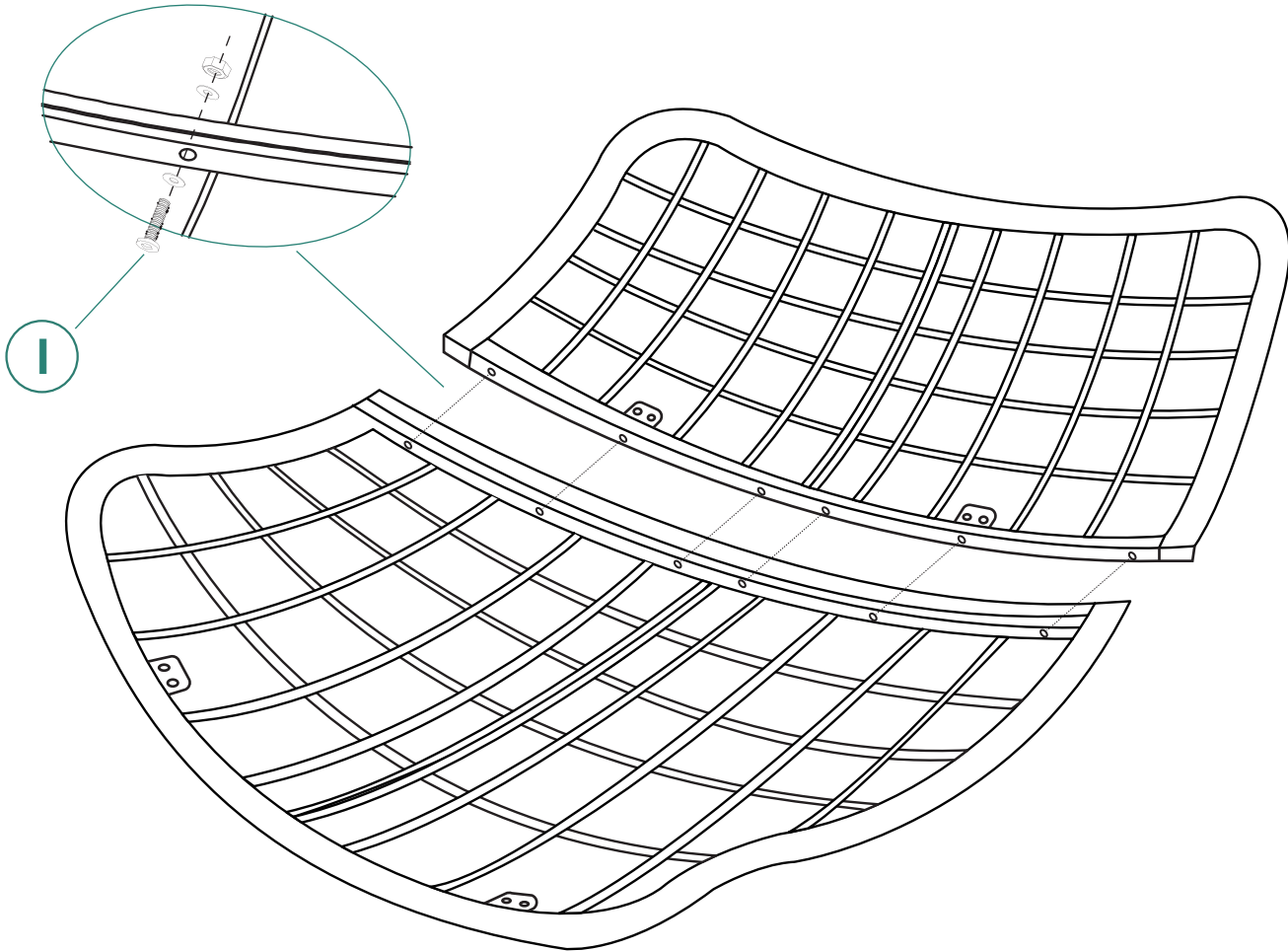

1. First, partially tighten all the screws to about 50% of the full torque, do not fully tighten them.

# 4

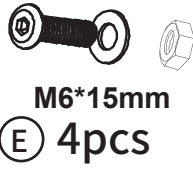
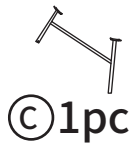

M6\*15mm

E 4pcs

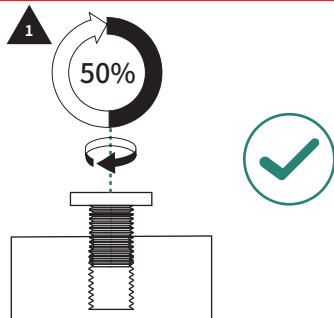
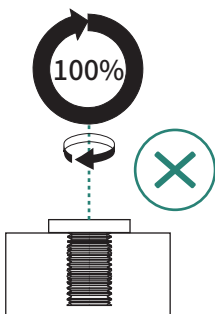
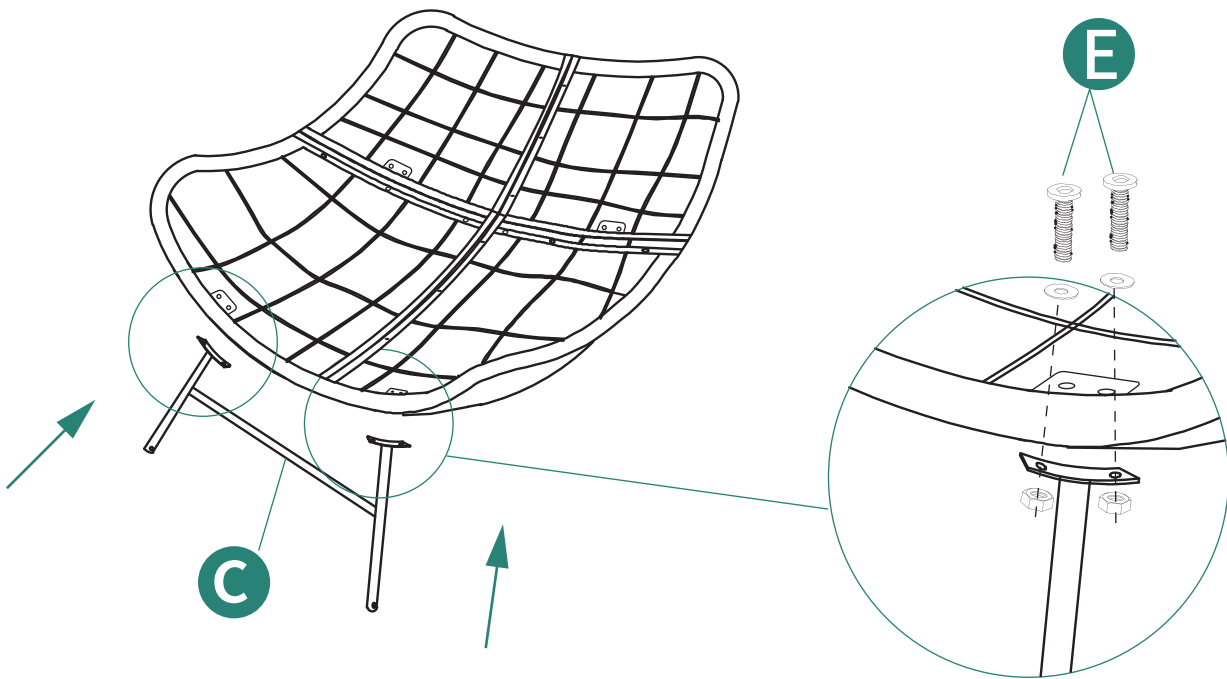

1. First, partially tighten all the screws to about 50% of the full torque, do not fully tighten them.

# 5

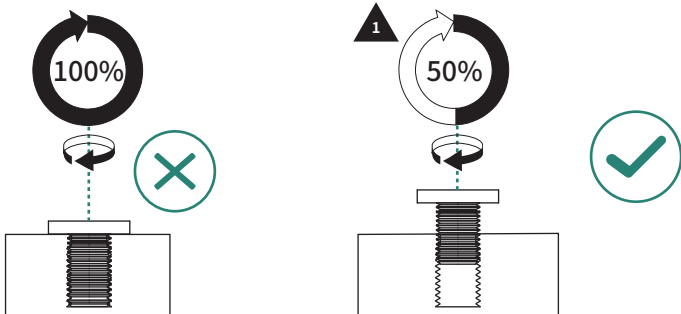
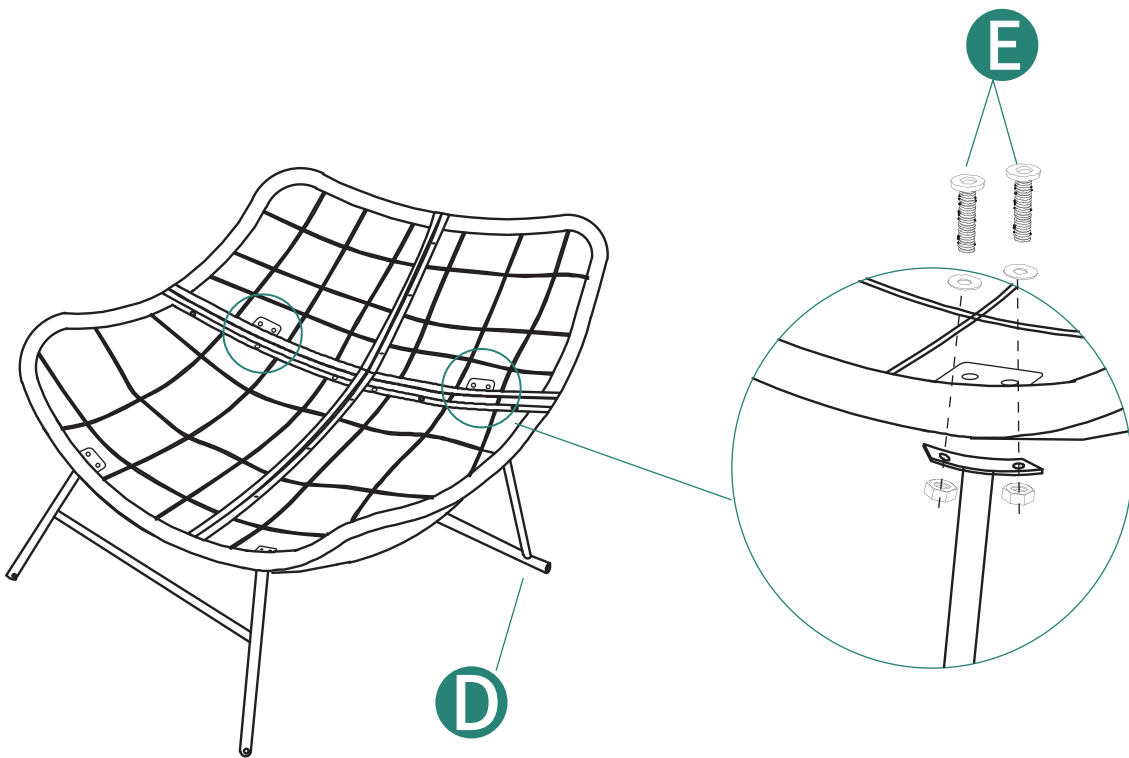
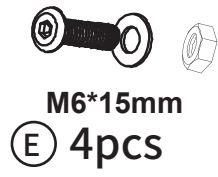
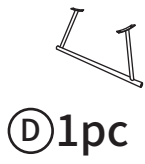

1. First, partially tighten all the screws to about 50% of the full torque, do not fully tighten them.

# 6



M6\*60mm

(F) 4pcs



(G) 2pcs

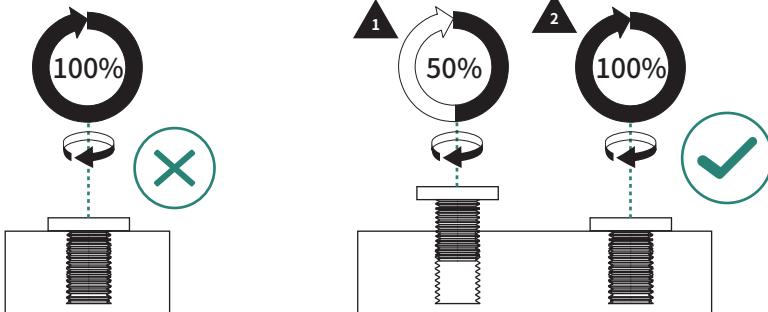
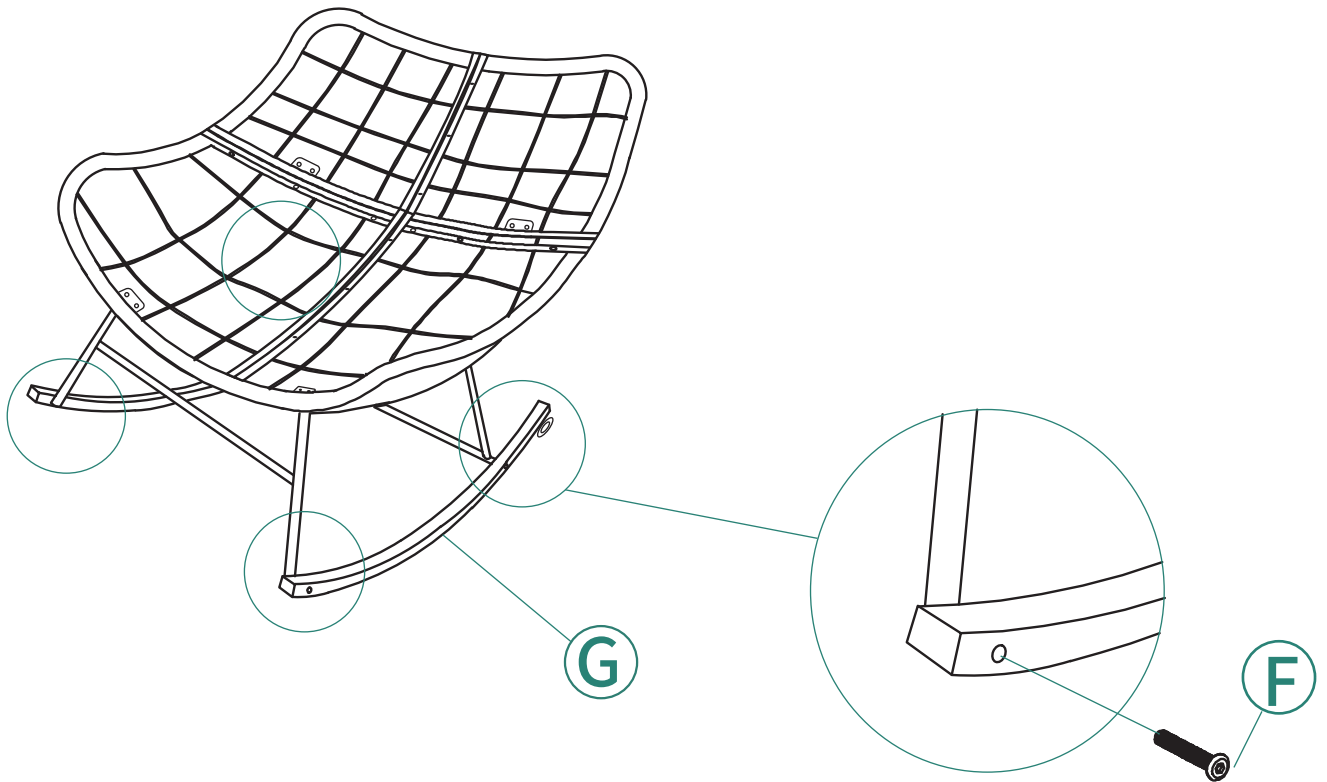

1. First, partially tighten all the screws to about 50% of the full torque, do not fully tighten them.

2. After all the screws in this step have been installed, then go back and fully tighten all the screws one by one.

7

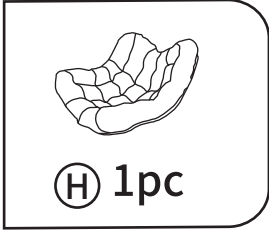

Ⓜ 1pc

Ⓜ



8



Installation Completed