



**Flex+ Series R410A  
Systems — Outdoor Unit**

**Owner's Manual Impecca Air**

---

**Conditioners**



ISMO-6021

Thank you for choosing Impecca air conditioners, please read this owner's manual carefully before operation and keep it for future reference.

Impecca reserves the right to interpret this manual which will be subject to any change due to product improvement without further notice.



## Preface

Flex + Series adopt the advanced manufacturing technology and takes the environmental-friendly R410A as refrigerant, which is a green product in the 21st century. Please carefully read the manual before installation and operation.

- 1) Flex + Series systems conform to design standard ARI 210240-2008.
- 2) To ensure safety when operating this system, please strictly follow the instructions in this manual.
- 3) Make sure that the manual is kept by the operators or serviceman.
- 4) The refrigerant pipes and accessories must be designed exclusively for R410A.
- 5) The total capacity of the indoor units which runs at the same time cannot exceed the capacity of the outdoor units; otherwise, the cooling (heating) effect of each indoor unit would be lower than the nominal capacity.
- 6) In case of malfunction, please examine the following items and contact our appointed service centers as soon as possible.
  - ◆ Nameplate (model, cooling capacity, product code, ex-factory date).
  - ◆ Malfunction status (detail description of conditions before and after malfunction occurs).
- 7) It is a normal phenomenon that the fan of indoor unit will still run for 20~70 seconds after the indoor unit receives the “stop” signal so as to make full use of the waste heat.
- 8) When the work mode of the indoors is conflict with the modes of outdoor units, it will be indicated on the display of the wired controller in five seconds and then the indoor unit will stop. In this case, please harmonize their work modes: the cooling mode is compatible with the dry mode.
- 9) If the supply power fails when the unit is running, then the indoor unit will send the “start” signal to the outdoor unit three minutes later after the power recovery.
- 10) The power cable and transmission line must not be twisted together, but instead of separated with an interval of at least 2cm; otherwise it may be result in communication problem.
- 11) This appliance is not intended for use by persons (including children) with reduced physical, sensory or mental capabilities, or lack of experience and knowledge, unless they have been given supervision or instruction concerning use of the appliance by a person responsible for their safety. Children should be supervised to ensure that they do not play with the appliance.
- 12) All graphics and information in this manual are only for reference. Manufacturer reserves the right for changes in terms of sales or production at any time and without prior notice.



This product must not be disposed together with the domestic waste. This product has to be disposed at an appointed place for recycling of electrical and electronic appliances.

**Thank you for purchasing Impecca air conditioners. Before using, please read this manual carefully and keep it properly for further reference.**





# Contents

1	Safety Precautions.....	1
2	Attention for Installation.....	3
2.1	Precautions for R410A.....	3
2.2	Precaution for Installation.....	3
2.3	Precaution for Operation Test.....	3
2.4	Accessories.....	3
3	Product Introduction.....	4
3.1	Names of Main Parts.....	4
3.2	Combinations for Outdoor and Indoor Units.....	4
3.3	Parts and Components of Unit.....	5
3.4	Working Temperature Range.....	5
4	Selection of Installation Location and Precautions.....	6
4.1	Selection of Installation Location.....	6
4.2	Outline Dimension of Outdoor Unit.....	7
4.3	Installation and Servicing Space.....	7
5	Installation Instruction.....	8
6	Installation of Refrigerant Pipes.....	9
6.1	Allowable Length and Drop Height of Connecting Pipe.....	9
6.2	Dimension of Connecting Pipe.....	10
6.3	Connection of Branch Pipe.....	10
6.4	Connection of Refrigerant Pipes.....	11
6.5	Connection of Refrigerant Pipe.....	12
6.6	Leak Test.....	13
6.7	Vacuum Operation.....	13
6.8	Refrigerant Charging.....	14
7	Electrical Wiring Work.....	17
7.1	Wiring Connection.....	17
7.2	Requirements of Power Circuit and Cable.....	17
7.3	Ground Requirements.....	18
7.4	Precautions on the Electrical Wiring Work.....	18
7.5	Precaution of Laying Wires.....	19
7.6	Procedures for Electrical Wiring Work.....	19
8	Design of Drainage Pipeline.....	20
8.1	Installation of Drain Hose.....	20
8.2	Design of Drainage Pipeline.....	20
9	Installation of Protective Layer.....	21
10	Test Operation.....	22
10.1	Check after Installation.....	22
10.2	Test Operation.....	22
11	Testing Board Introduction.....	23
11.1	Compose of the Testing Board.....	23
11.2	Instruction of Function and Data Section.....	23

12	Troubleshooting .....	24
12.1	Check before Contacting Service Center .....	24
12.2	Problem Handling .....	25
12.3	Error Description.....	25
13	Maintenance .....	28
13.1	Outdoor Condenser .....	28
13.2	Drain Pipe .....	28
13.3	Check before the Seasonal Use .....	28
13.4	Maintenance after Seasonal Use .....	28
14	After-sales Service .....	28



## 1 Safety Precautions

	This is the safety alert symbol. It is used to alert you to potential personal injury hazards. Obey all safety messages that follow this symbol to avoid possible injury or death.
 <b>WARNING</b>	This mark indicates procedures which, if improperly performed, might lead to the death or serious injury of the user.
 <b>CAUTION</b>	This mark indicates procedures which, if improperly performed, might possibly result in personal harm to the user, or damage to property.
<b>NOTICE</b>	NOTICE is used to address practices not related to personal injury.

 <b>WARNING</b>	
1)	Instructions for installation and use of this product are provided by the manufacturer.
2)	Installation must be performed in accordance with the requirements of NEC and CEC by appointed personnel only.
3)	The installation should be left to the appointed service center and according to the instructions given in the manual. Improper installation may cause fall down, water leakage, electric shock or fire etc.
4)	For operating the air conditioner pleasantly, please install it as outlined in this installation manual.
5)	The power supply must adopt the special circuit with air switch protection and assure it has enough capacity
6)	Connect the indoor unit, BU module and outdoor unit with the room air conditioner piping and cord available from our standard parts. This installation manual describes the correct connections using the installation set available from our standard parts.
7)	Before installation, check the parameter of power cord and make sure that it complies with the power supply requirement on the nameplate. Make sure the power supply is safe.
8)	This air conditioner must be properly grounded through the receptacle to avoid electric shock. The ground wire shouldn't be connected with gas pipe, water pipe, lightning arrester or telephone line.
9)	If refrigerant leaks while work is being carried out, ventilate the area. If the refrigerant comes in contact with a flame, it produces toxic gas.
10)	Do not power on until all installation work is complete.
11)	During installation, make sure that the refrigerant pipe is attached firmly before you start up the compressor. Do not operate the compressor under the condition of refrigerant piping not attached properly with valve open. This may cause abnormal pressure in the refrigeration cycle that leads to breakage and even injury.
12)	When installing and relocating the air conditioner, do not mix gases except the specified refrigerant (R410A) to enter the refrigerant cycle. If air or other gas enters the refrigerant cycle, the pressure inside the cycle will rise to an abnormally high value and cause breakage, injury, etc.
13)	This appliance is not intended for use by persons (including children) with reduced physical, sensory or mental capabilities, or lack of experience and knowledge, unless they have been given supervision or instruction concerning use of the appliance by a person responsible for their safety. Children should be supervised to ensure that they do not play with the appliance.
14)	Never cut off or damage power cables and transmission wires. If the power cable or transmission line were damaged, it must be replaced by the manufacturer, its service agent or similarly qualified persons in order to avoid a hazard.
15)	After the power cord is connected, please install the cover of electric box to avoid danger.

16) When installing or relocating the unit, please contact the appointed service center for the repair or relocation. Meanwhile the specialized parts and accessories must be used. Otherwise, it may result in water leakage, electric shock or fire hazard.
17) Diameter of power cord must be large enough. Damaged power cord or connecting wire must be replaced by specialized electric cable.
18) The power wire and transmission line must be more than one meter away from televisions or radios which can emit electromagnetic waves to prevent image interference or noise. Otherwise, the unit maybe not work
19) Nitrogen must be charged according to technical requirements.
20) For units with wired controllers, do not connect power supply until the wired controller is well installed. Otherwise, the wired controller cannot be used.
21) When installation is finished, please check and make sure the drain pipe, pipeline and electric wire are all well connected so as to avoid water leakage, refrigerant leakage, electric shock and fire hazard.
22) Never extend fingers or objects into air outlet or return air grille.
23) Please keep the room well-ventilated and it could avoid oxygen deficit.
24) Never start or stop the air conditioner by inserting or removing the power cord.
25) Before startup of the compressor, please turn on the main power switch of the unit for more than 8 hours and it makes sure that the heater belt of the compressor has been energized for at least eight hours! Once the compressor is started, it must be guaranteed that it works continuously for at least 30 minutes, otherwise it would be damaged!
26) Never operate the unit with wet hands. Otherwise, it may cause electric shock.
27) Before cleaning and repairing, it is necessary to stop working and turn off the power supply. Otherwise, it may cause electric shock or damage.
28) Do not spray water on the air conditioner or it will cause malfunction or electric shock.
29) The air conditioner is not support to install in the circumstances as the following that where there is full of mist of oil, damp or corrosive gas, flammable gases, the acidic or alkaline vapor and the ocean.
30) Volatile liquid like thinner or gasoline will damage the appearance of air conditioner. (Please use soft dry cloth and wet cloth with mild detergent to clean unit's appearance.)
31) Never standing or place objects on outdoor unit. Person or objects falling from the unit may cause injury.
32) If abnormal condition occurs (e.g. unpleasant smell), please turn off the unit at once and disconnect power supply. Then contact appointed service center. If the air conditioner continues to operate despite of abnormal condition, it may be damaged and cause electric shock or fire hazard.
33) The drain pipe should be installed as instructed in the manual to guarantee the proper drainage; meanwhile it should be insulated to prevent condensing; otherwise the improper installation would cause water leakage and then wet the household wares in the room.
34) Don't attempt to repair the air conditioner by yourself. The improper repair will lead to electric shock or fire, please contact the appointed service center and ask professional technicians to repair it.
35) Please take notice of the installation foundation of the unit after long use, if it is damaged, it may lead to the fall of the unit and cause the injury.
36) Be sure to shut off the power supply when you do not use the air conditioner for a long time. Otherwise, the dusts may accumulate in it, which may cause overheating or fire hazards.
37) Impecca is not responsible for any personal injury or property loss caused by improper installation, improper debugging, unnecessary repair or not following the instructions of this manual.

## **2 Attention for Installation**

### **2.1 Precautions for R410A**

- ◆ It is very strict that the refrigerant pipes should be clean and dry.
- ◆ The R410A is a mixed refrigerant, when adding the refrigerant to the unit, it must be in its liquid state. If the refrigerant is in gas state, the composition has been changed and the capability of the unit will decrease.
- ◆ When the refrigerant leaks out, please do not touch the leakage. Otherwise, it will result in frostbite.
- ◆ It does not support to let a lot of refrigerant go into the ambient atmosphere, because it will strengthen the green house effect. Otherwise, it will produce toxic gas when the refrigerant contacts with the fire.

### **2.2 Precaution for Installation**

- ◆ The unit is so heavy that it is more than 110kg, so more than two persons will be needed to remove the unit. The package cannot bear it, so do not grasping it.
- ◆ When remove the units, please place the hands on the corner and take care not to hurt the hands by the fins.
- ◆ It is very likely to dispose the waste to the garbage bin after the installation.

### **2.3 Precaution for Operation Test**

In order to protect the compressor from vibrating during transportation and 2 metal gaskets are used. They must be removed prior to commissioning and tied back the nut firmly; otherwise the unit might not be operated well.

### **2.4 Accessories**

For the accessories of the air conditioner, please look out the Packing List in the package.

### 3 Product Introduction

The Impecca Flex + Series adopts inverter compressor technology. According to change displacement of compressor, stepless capacity regulation within range of 10%~100% can be realized. Various product lineups are provided with capacity range from 14kW to 16kW, which can be widely used in residential house, business office, hotel and where especially applicable to the place with variable load change. Impecca air conditioner is absolutely your best choice.

#### 3.1 Names of Main Parts

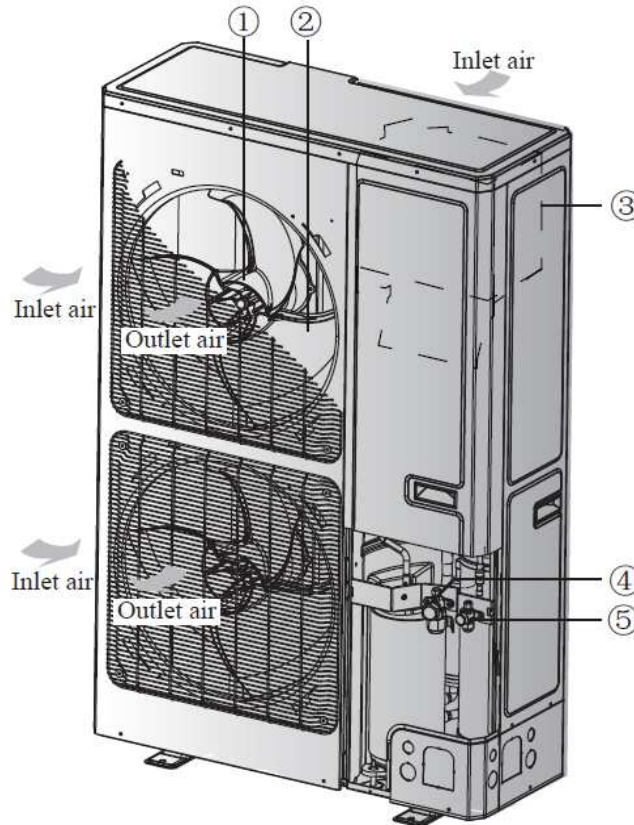

NO.	①	②	③	④	⑤
Name	Fan motor	Axial flow fan blade	Electrical box	Gas side stop valve	Liquid side stop valve

Fig. 1

#### 3.2 Combinations for Outdoor and Indoor Units

Table 1

Sorts		GWHD(56S)ND3CO	
No. of indoor units to be connected	Min	2	
	Max	9	
No. of BU modules to be connected	Min	1	
	Max	3	
Total capacity of indoor units to be connected(Btu/h)	Min	28000	
	Max	81000	

### 3.3 Parts and Components of Unit

For the Flex + Series, one outdoor unit is able to drive up to three BU modules and nine indoor units which include cassette type, duct type, wall mounted type, floor ceiling type and console type. The outdoor unit will run as long as any one indoor unit receives the running command, and all indoor units stop once the outdoor unit is turned off.

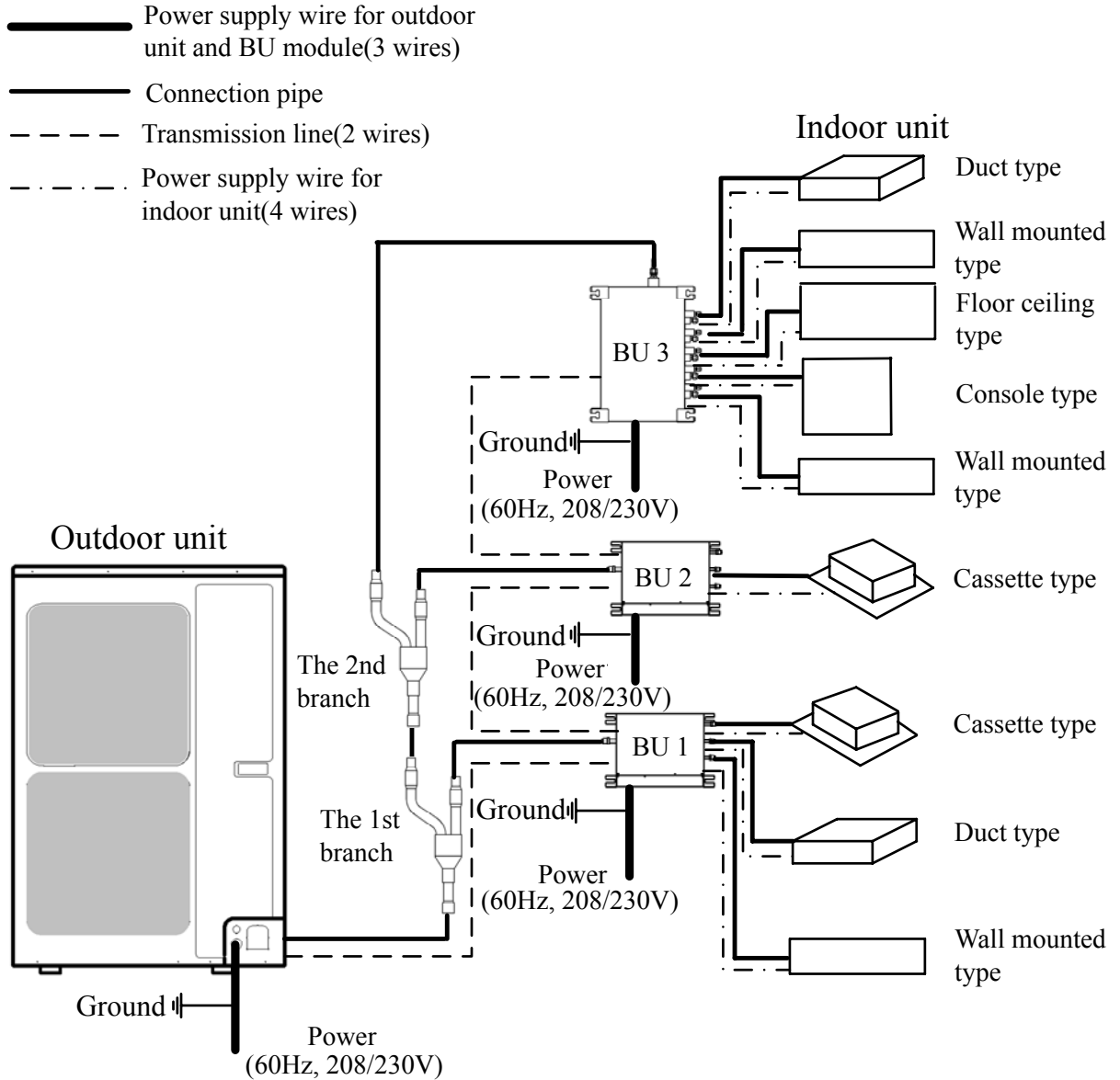

Fig. 2

### 3.4 Working Temperature Range

Table 2

Sorts	Outside temperature: DB(°C/°F)
Maximum cooling	48°C(118°F)
Minimum cooling	-18°C(0°F)
Maximum heating	24°C(75°F)
Minimum heating	-20°C(-4°F)



## 4 Selection of Installation Location and Precautions

### **⚠ WARNING**

- 1) The installation of the air conditioner must be in accordance with the national and local laws and regulations.
- 2) The quality of the installation will affect the capability of air conditioner directly. The installation should be left to the appointed service center. Please contact your dealer after purchasing this machine. Professional installation workers will provide installation and test services according to the installation manual.
- 3) The air conditioner should not install in this place where the small animals exist, because they may cause malfunctions, smoke or fire. Please keep the area around the unit clean.

### 4.1 Selection of Installation Location

### **⚠ WARNING**

- 1) The outdoor unit must be installed on a firm and solid support which can withstand the weight, meanwhile the mounting surface must be horizontal plane. Otherwise, the unit would fall down and cause injury or death.
- 2) The location must be out of children's reach, please keep the unit away from children.
- 3) During installation, if the outdoor unit has to be exposed to strong wind, it must be fixed securely.
- 4) There is enough space for the installation and maintenance. Meanwhile, there is not any obstacle near the air inlet and outlet of the indoor and outdoor units.
- 5) The place should be well-ventilated, so the machine can absorb and discharge sufficient air.
- 6) Avoid place the outdoor unit under the windows or between the constructions, hence to prevent normal operating noise from entering the room.
- 7) When strong winds of 5 m/sec or more exist in the place of the installation, the outlet of the unit cannot face the wind. If the wind blows against the outdoor unit's air outlet, it will cause deterioration of the operational capacity and maybe break the fan.
- 8) Do not install in the place where there is heat source, flammable or explosive gas, a place subject to severe dust, salty fog and polluted air.
- 9) Installation at the following places might lead to the air conditioner malfunction, such as where is full of machine oil, saline-sodic soil near the sea, sulphide fog, high frequency facilities or special conditions. If it is unavoidable, please contact the appointed service center.

### **NOTICE**

- 1) It is better that do not install the unit where it will be exposed to direct sunlight. (If necessary, please install a blind that does not interfere with the air flow.)
- 2) The unit should be free from getting dirty or getting wet by rain as much as possible
- 3) Outdoor unit shall be installed close to the indoor unit, hence to minimize the length and bends of cooling pipe.
- 4) Do not place animals and plants in the path of the air inlet and outlet of the units.
- 5) Make sure that the unit will not cause any operating vibration or noise after installation.

### 4.2 Outline Dimension of Outdoor Unit

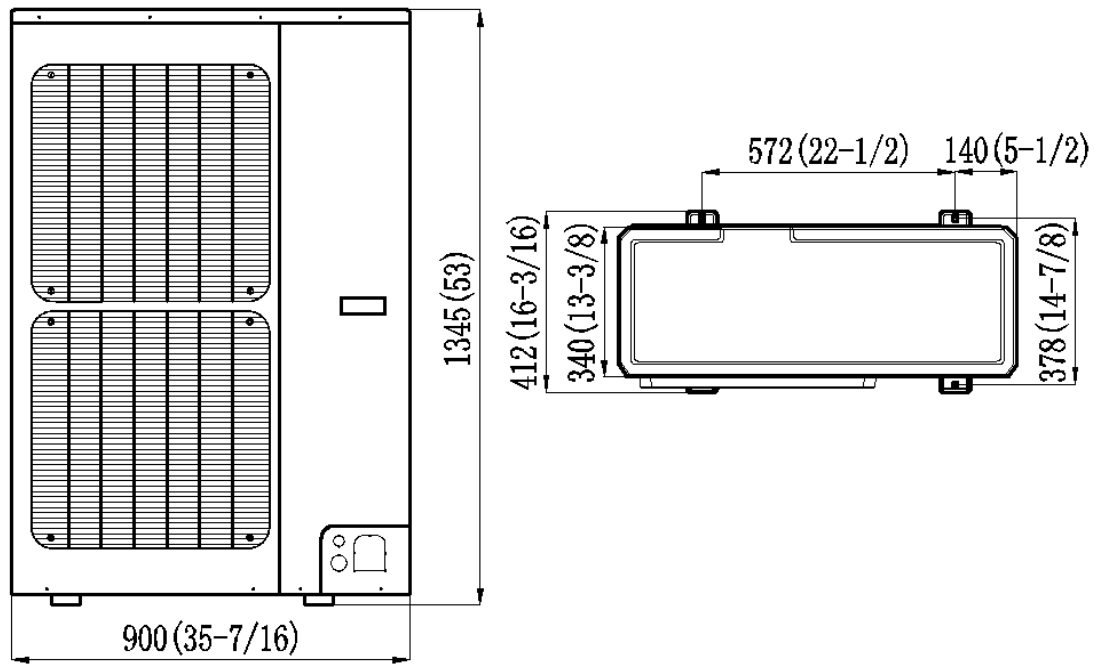

Fig. 3 (unit: mm/inch)

### 4.3 Installation and Servicing Space

- 1) In case of installing only one unit

In case obstacles exist around the unit, the required installation space is in the Fig. 4.

- 2) In case of installing multiple units(2 units or more)

In case multiple rows of series installation, the required installation space is in the Fig. 5.

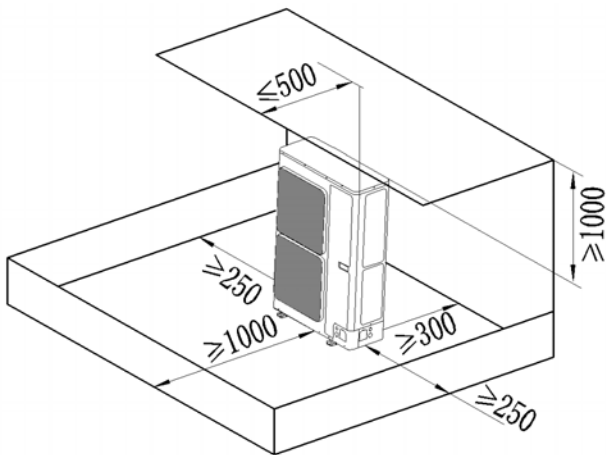

Fig. 4 (unit: mm)

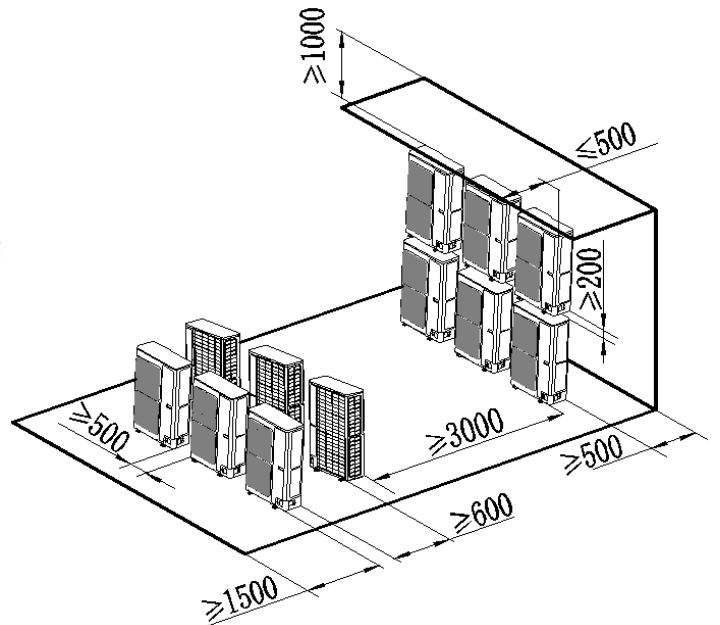

Fig. 5 (unit: mm)

## 5 Installation Instruction

- 1) Check the installation location and ensure it is strength and level, so that the unit will not cause any operating vibration or noise after installation.
- 2) In accordance with the foundation drawing in the following figure, please drill 4 holes in the installation location.

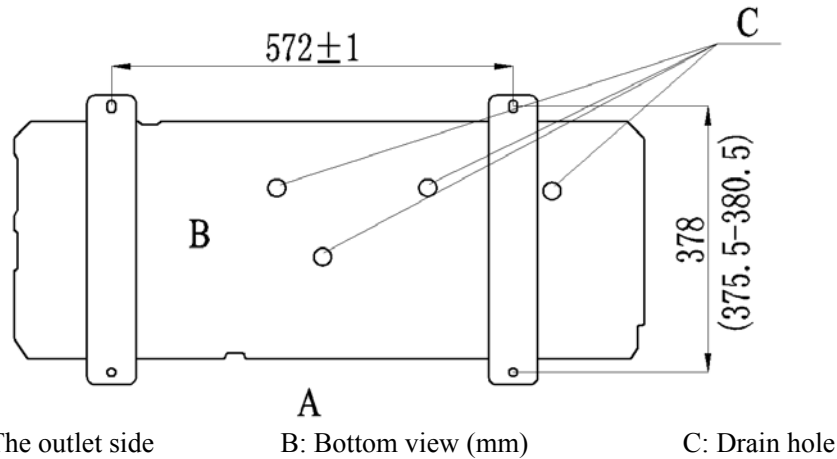

Fig. 6

- 3) Fix the unit securely with the foundation bolts. You can get the M10 or M12 foundation bolts, nuts and washers from the market.

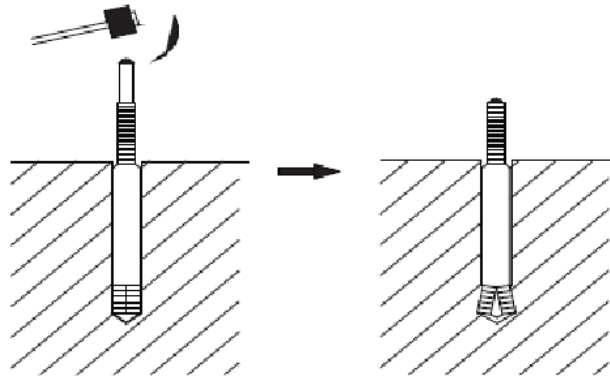

Fig. 7

- 4) Rubber or spring shock absorbers should be used during the installation of the outdoor unit to meet the noise and vibration requirements.
- 5) Screw the foundation bolts into the ground and it is better that its length is less than 20mm (4/5inch) from the foundation face.

## 6 Installation of Refrigerant Pipes

### 6.1 Allowable Length and Drop Height of Connecting Pipe

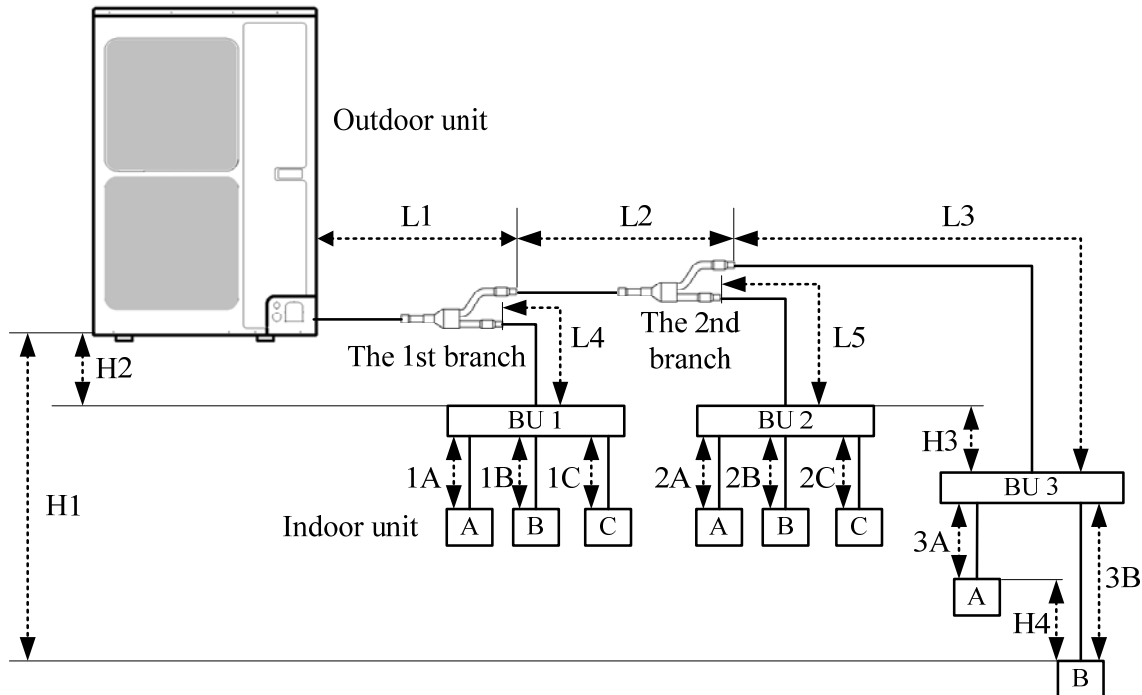

Fig. 8 (8 indoor units)

Table 3

The sorts		The pipes	Length(m/feet)
Maximum allowable length	Total length between outdoor unit and BU modules	$L1+L2+L3+L4+L5$	$\leq 55(181)$
	Total length between indoor units and BU	$1A+1B+1C+2A+2B+2C+3A+3B$	$\leq 90(295)$
	Between indoor unit and BU module	$1A;1B;1C;2A;2B;2C;3A;3B$	$\leq 15(49)$
	Between indoor unit and the 1st branch	$L4+1B;L2+L5+2A;L2+L3+3B$	$\leq 40(131)$
Maximum allowable length	Between outdoor and indoor units	$H1$	$\leq 30(99)$
	Between outdoor units and BU modules	$H2$	$\leq 30(99)$
	Between BU and BU modules	$H3$	$\leq 15(49)$
	Between indoor and indoor units	$H4$	$\leq 15(49)$
Minimum allowable length	Between outdoor and the 1st branch	$L1$	$\geq 5(16)$
	Between BU and the branch	$L3;L4;L5$	as possible as short

**NOTICE!** BU module should be placed within the level between the outdoor unit and indoor unit.

## 6.2 Dimension of Connecting Pipe

Table 4

Sorts		Gas Pipe (mm/inch)	Liquid Pipe (mm/inch)
Outdoor unit	ISMO-6021	Φ15.9(5/8)	Φ9.52(3/8)
Between outdoor unit and the 1st branch	The pipe L1	Φ19.05(3/4)	Φ9.52(3/8)
Between the 1st and the 2nd branch	The pipe L2	Φ15.9(5/8)	Φ9.52(3/8)

## 6.3 Connection of Branch Pipe

- 1) If two or three BU modules used, Y-type branch pipe of FQ01A/A will be chosen.

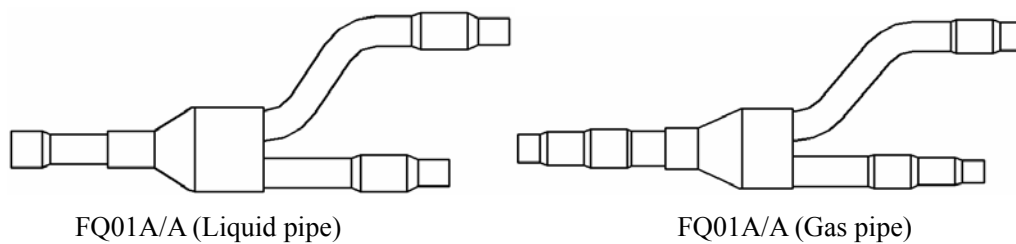

Fig. 9

- 2) Y-type branch pipe is equipped with auxiliary tubes to adjust the diameter of different pipes. If the dimension of the pipe selected is different from the dimension of branch pipe joint, Cut the copper tube in the middle with tube cutter and clear up burrs. Please do that as following figure.

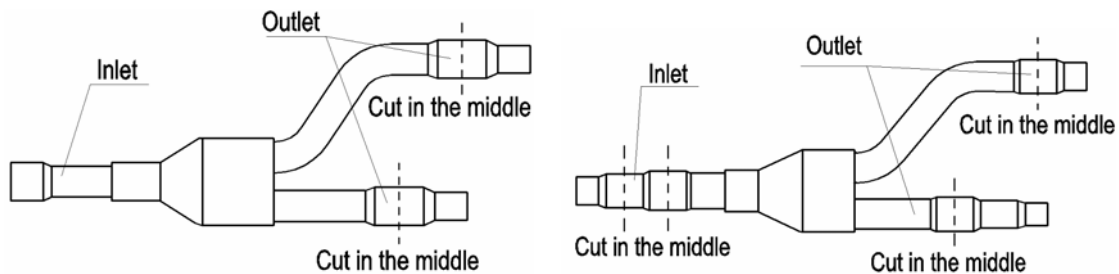

Fig. 10

- 3) Y-type branch pipe must be installed in vertical or horizontal direction. In the inlet of the branch pipe, keep at least 500mm straight pipe.

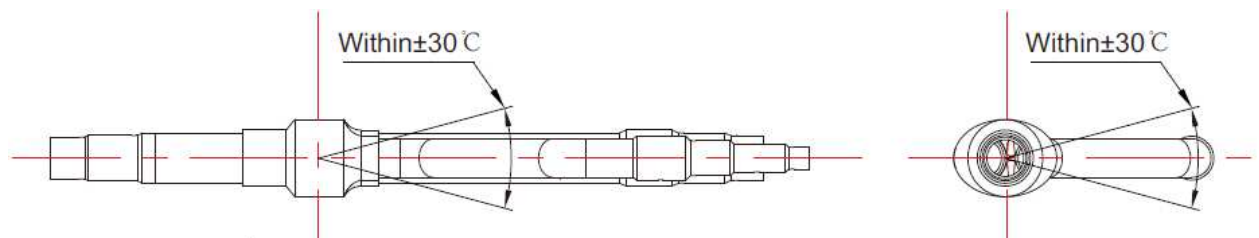

Fig. 11

## 6.4 Connection of Refrigerant Pipes

### ⚠ CAUTION

- 1) Conform to the following principles during pipe connection: Outdoor unit shall be installed close to the indoor unit, hence to minimize the length and bends of connection pipes; the height gap of outdoor unit and indoor units should be as small as possible; the radius of curvature should be as large as possible.
- 2) The brazing operation must be strictly in accordance with the process requirements. Rosin joint or pin hole is not allowed.
- 3) During the installation, do not damage the pipeline. The pipeline's radius of bending must be over than 200mm(8inch). The pipes cannot repeatedly be bent or straightened. Otherwise it will get harden and crack. Do not bend or straight the pipes for more than 3 times at the same position.

- 1) The process of flaring
  - ① Using the tube cutter to cut the connecting pipe in the appropriate place and remove the burrs.
  - ② Install the nut before the flaring operation.
  - ③ Check the flared portion, whether there is fractured or not.

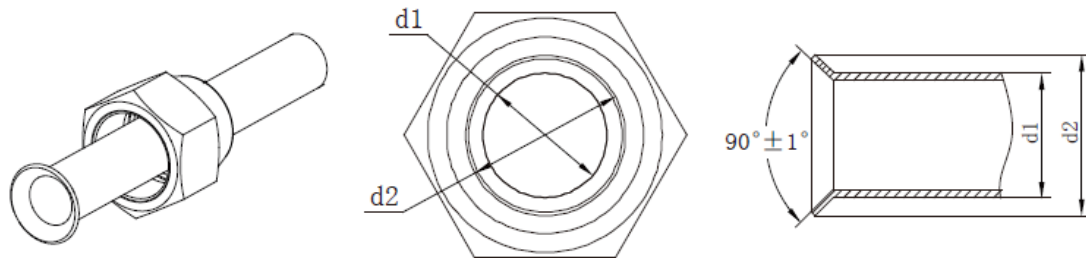

Fig. 12

- 2) Precaution for elbow operation
  - ① The elbow operation could be done by hands. Be careful and do not damage the pipe.

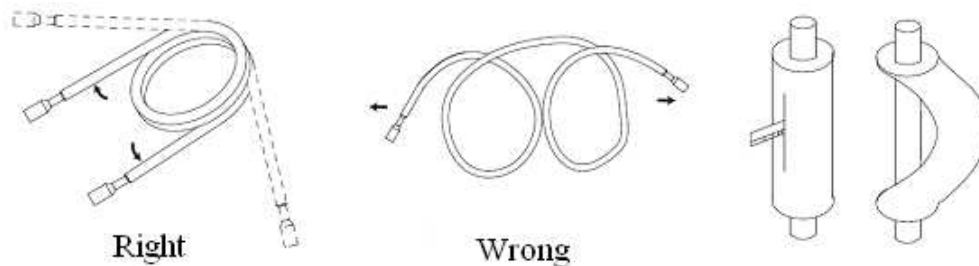

Fig. 13

- ② If the thermal insulation of the refrigerant pipe is not removed, please do not bend the pipe. Otherwise, it maybe leads the pipe to crack. It is better to make an incision with a knife in the thermal insulation and removes it. After elbow operation is finished, recover the thermal insulation with binding band.
- 3) The process of install refrigerant pipes
  - ① Remove the screw caps from the pipes.
  - ② Align the flared end of copper tube with the center of pipe joint. Tighten the nuts by hands. (If the flared end of copper tube and the center of pipe joint are not in coaxial, it is hard to tighten the nuts by hands, please do not tighten it with spanners, because the screw thread may be broken by force).
  - ③ Tighten the flaring nuts with torque wrench until you hear a “click”. (The spanner and torque

wrench should be perpendicular to the refrigerant pipeline).

- ④ The following table for the torque required to tighten the nuts.

Table 5

Pipe diameter (mm/inch)	Thickness of copper tube(mm/inch)	Tightening torque (N·m/lbf·ft)
Φ6.35(1/4)	≥0.8(1/32)	15~30(11~22)
Φ9.52(3/8)	≥0.8(1/32)	35~40(26~29)
Φ12.7(1/2)	≥0.8(1/32)	45~50(33~37)
Φ15.9(5/8)	≥1.0(1/25)	60~65(44~48)
Φ19.05(3/4)	≥1.0(1/25)	70~75(52~55)

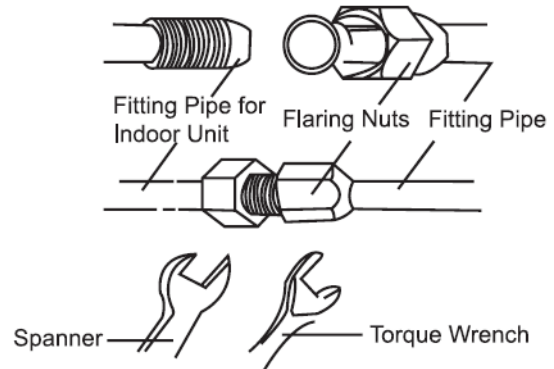
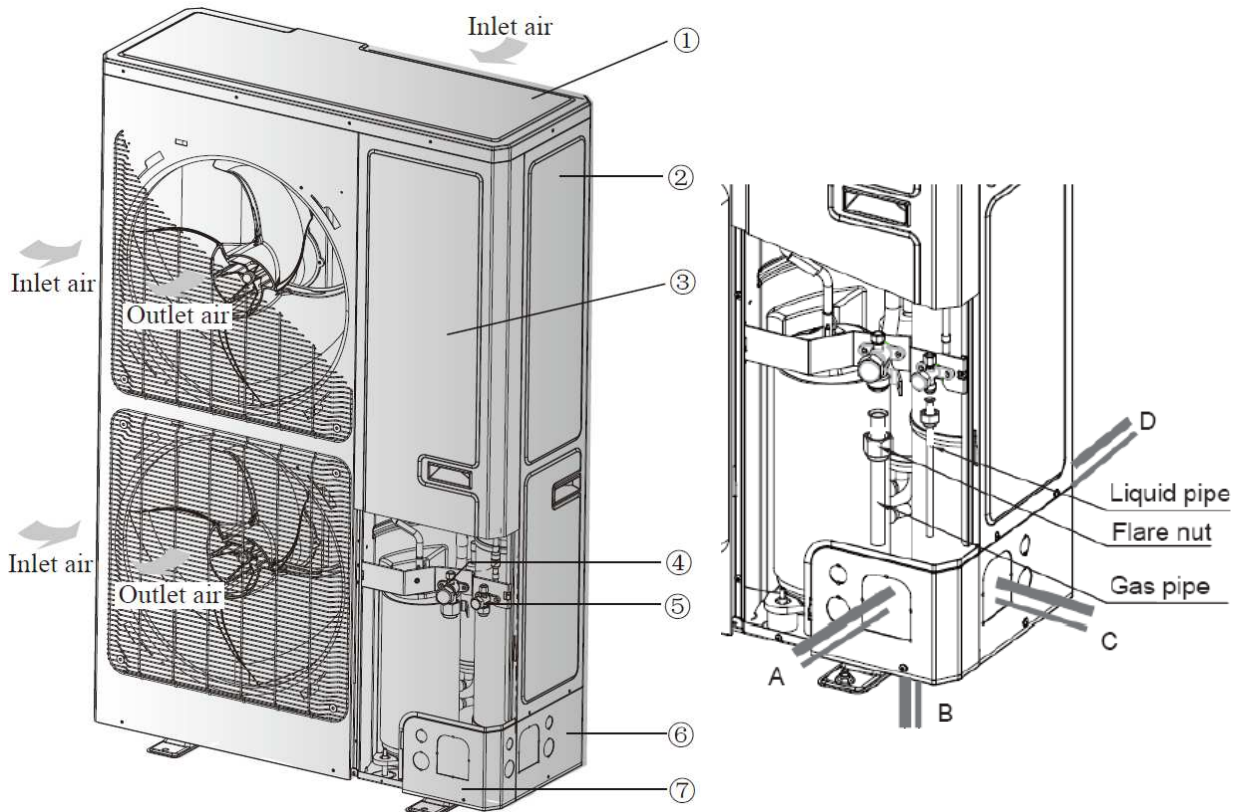

Fig. 14

### ⚠ CAUTION

- 1) During the connection of the indoor unit and BU module to the refrigerant pipe, never pull any joints of the indoor unit and the BU module by force; otherwise the capillary pipe or other pipe may crack, which then would result in leakage.
- 2) The refrigerant pipe should be supported by brackets, that is, don't let the unit withstand the weight of it.
- 3) For the Flex + Series, each pipe should be labeled to tell which system it belongs to avoid mistaken inaccurate piping.

## 6.5 Connection of Refrigerant Pipe



NO.	①	②	③	④
Name	Coping plate	Rear side plate	Front side plate	Gas side stop valve
NO.	⑤	⑥	⑦	
Name	Liquid side stop valve	Right connection board	Front connection board	
NO.	A	B	C	D
Name	Front connection	Bottom connection	Side connection	Rear connection

Fig. 15

- 1) Unscrew the coping plate, front side plate, right connection board and front connection board.
- 2) The refrigerant pipes can be installed in four directions, please choose the proper direction.
- 3) Knock the holes in the plate of the chosen direction with the drill and hammer.
- 4) Connect the pipes to the stop valves.
- 5) Bend the pipes to go through the knockout holes.
- 6) Cover the through-holes with sealing materials to prevent the water, dust or small animals going into the outdoor unit.

### 6.6 Leak Test

- 1) Please make sure that the stop valves of the outdoor unit are closed during the operation.
- 2) The leak test should be made by pressurizing nitrogen gas. **⚠ WARNING! Do not mix oxygen, C<sub>2</sub>H<sub>2</sub> or other dangerous gas into the refrigerant circuit.**
- 3) Turn on the Hi-knob and Lo-knob. **NOTICE! The leak test should be done simultaneously at both the gas and liquid stop valves.**
- 4) Open the pressure reducing valve, pressurize the connection pipes to 1.0 MPa (10 bar) slowly, wait fifteen minutes, and make sure that the pressure will not drop.
- 5) Rise the pressure to 4.0 MPa (40 bar) slowly, wait 24 hours and make sure the pressure will not drop
- 6) If the pressure does not decrease, the pipes have passed the test. Otherwise, look for where the gas leaks from.

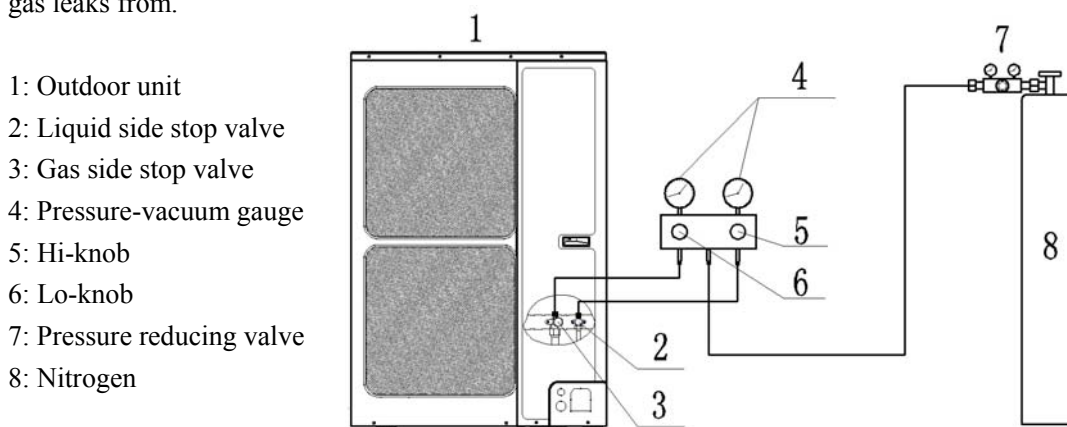

Fig. 16

### 6.7 Vacuum Operation

- 1) Make sure the stop valves of the outdoor unit are closed fully during the operation.
- 2) As shown in the following figure, expel the gas from the refrigerant pipes by the vacuum pump.
- 3) Open the pump and turn on the knobs to evacuate the gas in the liquid and gas pipes. **NOTICE! The vacuuming should be done simultaneously at both the gas and liquid stop valves.**
- 4) When the pressure of the system is less than -0.1Mpa (-1bar), keep the system for more than

one hour under the condition.

- 1: Outdoor unit
- 2: Liquid side stop valve
- 3: Gas side stop valve
- 4: Pressure-vacuum gauge
- 5: Hi-knob
- 6: Lo-knob
- 7: Vacuum pump

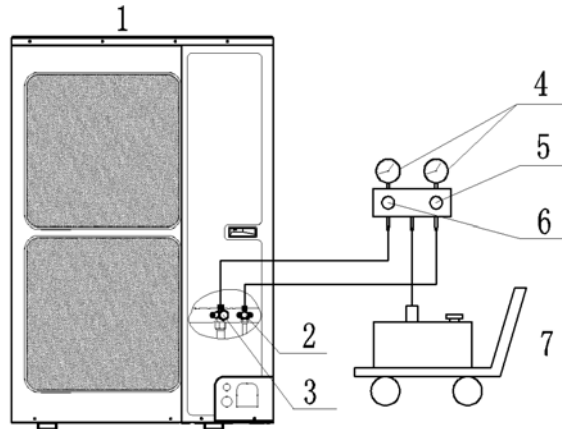

Fig. 17

- 5) Turn off the knobs firstly and then the pump, and if the pressure of the pressure-vacuum gauge does not rise within 2 hours, the system is under a vacuum. Otherwise, the system has leaked, please look for where the gas leaks in.

### 6.8 Refrigerant Charging

The refrigerant has been charged into the outdoor unit before shipped from the manufacturer, while additional refrigerant still need be charged into the refrigerant pipe in the field installation.

#### 6.8.1 Calculation of the Additional Refrigerant Charging

- 1) Get the refrigerant charge of the outdoor unit from the nameplate.

<b>NOTICE</b>
1) The refrigerant charge of the outdoor unit does not include the charged additionally in the indoor unit, BU module and the refrigerant pipe.
2) For the length of the connecting pipe is decided on the field, the amount of additional refrigerant shall be decided depending on the dimension and the length of the liquid pipe used on the field.
3) It does not need to add refrigerant if the total length of liquid pipe is within 30m (98-3/8feet).
4) Record the amount of additional refrigerant for convenience of future maintenance.

- 2) Calculating the Mass of Additional Refrigerant

Additional Refrigerant Charge (kg/oz) =  $\Sigma$  the Liquid Pipe Length of  $\Phi 6.35 \times 0.022\text{kg/m}$  (0.020oz/inch) +  $\Sigma$  the Liquid Pipe Length of  $\Phi 9.52 \times 0.054\text{kg/m}$  (0.048oz/inch) - 1.47kg(51.86oz)

**NOTICE! If the additional refrigerant charge is negative, it does not need to add refrigerant.**

- 3) Example: GWHD(56S)ND3CO

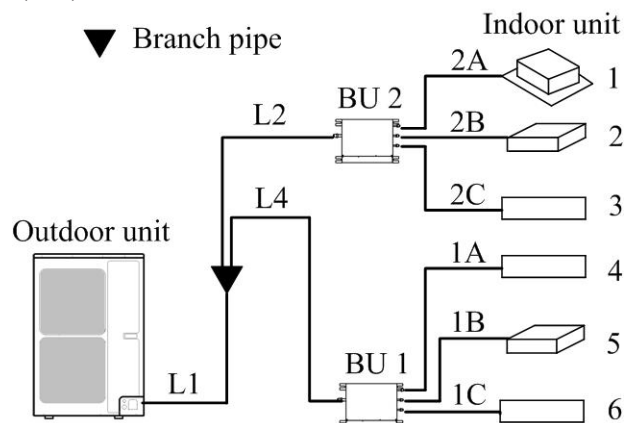

Fig. 18

Table 6

Serial No.	Model	
Indoor unit 1	Cassette type	ISMI-C15
Indoor unit 2	Duct type	N/A
Indoor unit 3	Wall mounted type	ISMI-W092
Indoor unit 4	Wall mounted type	ISMI-W092
Indoor unit 5	Duct type	N/A
Indoor unit 6	Wall mounted type	ISMI-W092

Table 7

Serial	Diameter(mm/inch)	Length(m/feet)
L1	Φ9.52(3/8)	20(65-5/8)
L2	Φ9.52(3/8)	10(32-3/4)
L4	Φ9.52(3/8)	10(32-3/4)
1A	Φ6.35(1/4)	5(16-3/8)
1B	Φ6.35(1/4)	5(16-3/8)
1C	Φ6.35(1/4)	5(16-3/8)
2A	Φ6.35(1/4)	5(16-3/8)
2B	Φ6.35(1/4)	5(16-3/8)
2C	Φ6.35(1/4)	5(16-3/8)

The total length of the liquid pipes:  $20+10+10+5+5+5+5+5+5=70\text{m}$  (229-5/8feet).

Thus, the total length is over than 30m (98-3/8feet), so the air conditioner needs to add refrigerant.

◆ Additional refrigerant charge

$\Sigma$  the Liquid Pipe Length of  $\Phi 6.35 \times 0.022\text{kg/m} + \Sigma$  the Liquid Pipe Length of  $\Phi 9.52 \times 0.054\text{kg/m} - 1.47\text{kg}$

$= (5+5+5+5+5)(\text{m}) \times 0.022\text{kg/m} + (20+10+10)(\text{m}) \times 0.054\text{kg/m} - 1.47\text{kg}$

$= 1.35\text{kg}$  (47.63oz)

4) Additional refrigerant charge record for future maintenance

Table 8

Diameter(mm)	Total length(m/feet)	Additional refrigerant charge(kg/oz)
Φ6.35(1/4)		
Φ9.52(3/8)		
Total		

6.8.2 Procedures for adding refrigerant

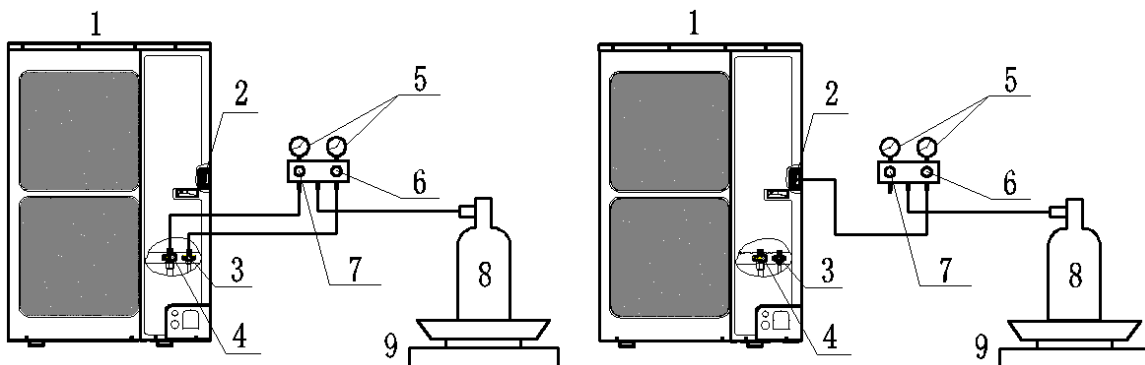

NO.	1	2	3	4	5
Name	Outdoor unit	Service port	Liquid side stop valve	Gas side stop valve	Pressure-vacuum gauge
NO.	6	7	8		9
Name	Hi-knob	Lo-knob	R410A tank		Scale

Fig. 19

- 1) When the liquid and gas stop valves have not been opened, the system is under the vacuum:
  - ① Refer to the left of the figure above; connect the R410A tank to the system.
  - ② Turn on the R410A tank and the Hi-knob; charge the R410A refrigerant into the unit from the liquid side stop valve. The Lo-knob should be closed completely.
  - ③ Turn off the R410A tank and the Hi-knob immediately, when the adding refrigerant is enough.
  - ④ Turn on the liquid and gas side stop valves in an anticlockwise direction slowly and completely.
- 2) If the pressure of the system is too high to charge refrigerant, you can do as follow.
  - ① Turn on the liquid and gas side stop valves in an anticlockwise direction slowly and completely.
  - ② Turn on the power of the air conditioner, and set cooling mode, running more than 0.5h when outside temperature is higher than 15°C(59°F) DB.
    - a) Refer to the left of the figure above; connect the R410A tank to the system.
    - b) Turn on the R410A tank and the Lo-knob; charge the R410A refrigerant into the unit from the gas side stop valve. The Hi-knob should be closed completely.
    - c) Turn off the R410A tank and the Lo-knob immediately, when adding refrigerant is enough.
  - ③ Turn on the power of the air conditioner, and set heating mode, running more than 0.5h when outside temperature is lower than 15°C(59°F) DB.
    - a) Refer to the right of the figure above; connect the R410A tank to the system.
    - b) Turn on the R410A tank and the Hi-knob; charge the R410A refrigerant into the unit from the service port. The Lo-knob should be closed completely.
    - c) Turn off the R410A tank and the Hi-knob immediately, when adding refrigerant is enough.

**⚠ CAUTION**

- 1) Make sure that the liquid and gas side stop valves are opened completely after the installation.
- 2) Make sure that the length of liquid pipe is exactly.
- 3) Additional refrigerant charge must be measured exactly.
- 4) Make sure that the refrigerant which charge into the unit is in liquid state.
- 5) Please prevent the refrigerant leakage away from your body when remove the charging hose.
- 6) Please heat the refrigerant tank with hot water or hot air when the outside temperature is too low. However, it must be forbidden to heat with fire directly, otherwise it may lead to explosion.

## 7 Electrical Wiring Work

### 7.1 Wiring Connection

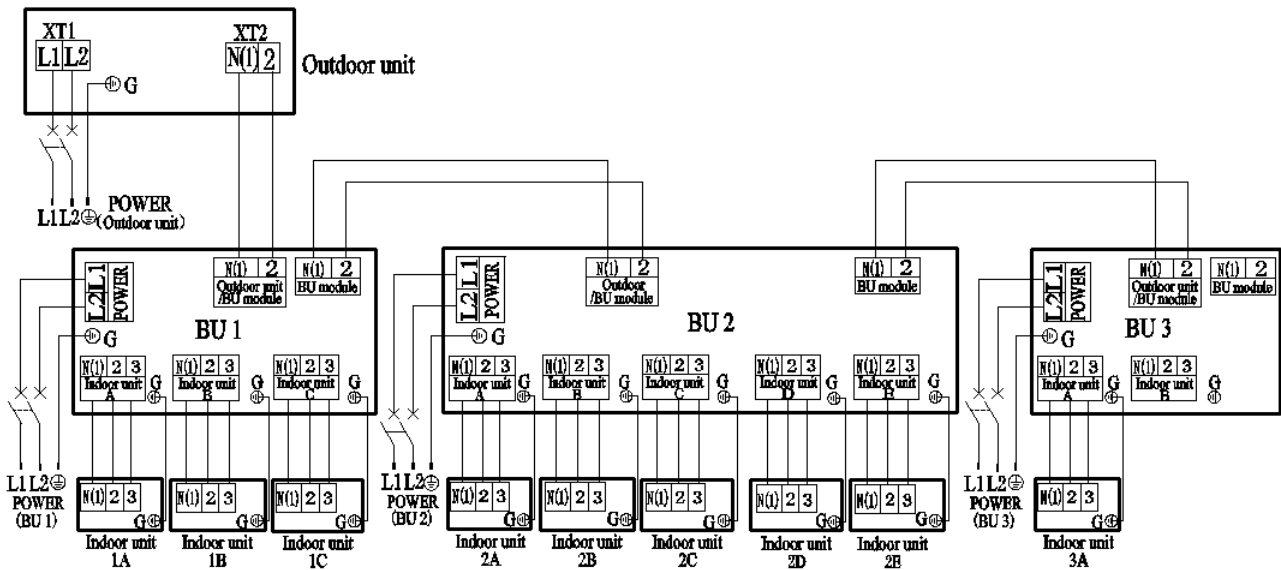

**NOTICE!** The “L1”, “3” terminals are connected to the live wire, the “L2”, “N(1)” terminals are connected to the neutral wire and the “2” terminal is connected to the transmission line.

Fig. 20

### 7.2 Requirements of Power Circuit and Cable

Table 9

Phase and frequency	1Ph,60Hz	
Voltage	208/230V	
Recommended cable of outdoor unit (Pieces × Sectional area)	3×6.0 mm <sup>2</sup>	
Recommended cable of BU module (Pieces × Sectional area)	3×0.75 mm <sup>2</sup>	
Transmission line (Pieces × Sectional area)	2×1.5 mm <sup>2</sup>	
Recommended cable of indoor unit (Pieces × Sectional area)	4×0.75mm <sup>2</sup>	
Capacity of the air switch	ISMO-6021	40A
	BU module	10A

### **NOTICE**

- 1) The total length of the transmission line between the outdoor unit and the furthest BU module is not more than 55m (180feet). Otherwise, the system cannot work possibility.
- 2) The specifications of the power cable and transmission line listed in the table above are determined based on the maximum power (maximum amps) of the unit.

3)	The specifications of the power cable listed in the table above are applied to the conduit-guarded multi-wire copper cable (like, YJV copper cable, consisting of PE insulated wires and a PVC cable jacket) used at 40°C(104°F) and resistible to 90°C(194°F), and shall be at least those of ordinary polychloroprene sheathed cords. If the working condition changes, they should be modified according to the related national standard.
4)	The specifications of the air switch listed in the table above are applied to the breaker with the working temperature at 40°C(104°F). If the working condition changes, they should be modified according to the related national standard.
5)	The length of the recommended power cable should be less than 15meters (49feet); otherwise, the diameter of the power cable is not enough.
6)	Mentioned power cable and transmission line length is just a reference value. It may be different depending on the condition of installation, humidity or materials, etc.
7)	An all-pole disconnection switch having a contact separation of at least 3mm in all poles should be connected in fixed wiring.

### 7.3 Ground Requirements

<b>⚠ WARNING</b>	
1)	The air conditioner is classified into the Class I appliances, so its ground ways must be reliable.
2)	The ground wire must be fixed on the screw hole with the sign as the right figure. 
3)	The yellow-green wire of the air conditioner is the ground wire and must be fixed by the tapping screw. And it cannot be used for other purpose or cut off. Otherwise, it will cause the hazard of electric shock.
4)	The reliable ground terminal should be provided and the ground wire cannot be connected to any of the following places: a. Water pipe; b. Coal gas pipe; c. Sewage pipe; d. Lightning rod e. Telephone line f. Other unreliable places considered by a professional.

### 7.4 Precautions on the Electrical Wiring Work

<b>⚠ WARNING</b>	
1)	The electrical installation should be carried out by the professional as instructed by the local laws, regulations and also this manual.
2)	The ground connection should be reliable and the ground wire should be connected to the dedicated device of the building by the professional.
3)	Before starting work, the power must not be supplied to the unit.
4)	The air switch coupled with the leakage current protection switch must be equipped in the circuits, which is of enough capacity and of both magnetic and thermal tripping functions in case of the short circuit and overload.
5)	The electrical work should use a cable length enough to cover the entire distance with no connection. If it is unavoidable, please make sure the connection should be reliable, the external forces will not act on the wires and the joint is not bared. Otherwise it will cause electrical shock or fire etc.
6)	The power cable with the rated voltage and exclusive circuit for the air conditioner should be used.
7)	Do not pull the power cable by force after it is installed.
8)	The diameter of the power cable should be large enough and once it is damaged, it must be replaced by the dedicated one.
9)	The multi-wire copper cable should be used for the power cable and the transmission line.

### 7.5 Precaution of Laying Wires

- 1) Use a wire stripper to strip off a length of the insulation layer at the end of the wires;
- 2) Loosen the screws on the terminal block of the air conditioner;
- 3) Press the ends of the cable tightly onto the round terminals corresponding to the size of the screws.
- 4) Pass the screw through the round terminals and fix it onto the terminal block.

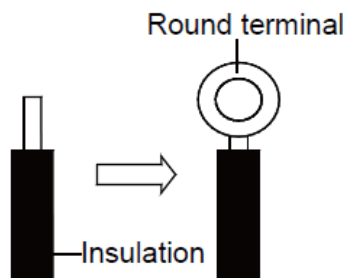

Fig. 21

### 7.6 Procedures for Electrical Wiring Work

- 1) Knock the holes in the plate of the chosen direction with the hammer.
- 2) Place the rubber ring on the knockout hole.
- 3) Let the power cable and transmission line go through the knockout hole.
- 4) Connect the power cable of the outdoor unit to the L1, L2 terminals with the sign of the XT1 and as well as the ground screw.
- 5) Connect the transmission line of the outdoor unit to the N(1), 2 terminals with the sign of the XT2.
- 6) Fix the power cable and transmission line firmly by cable fixing clip. In order to protect the power cable and transmission line from damage by the pipes or others, an interval of at least 2cm (3/4inch) away is essential.
- 7) Screw the coping plate, front side plate, right connection board, front connection board back.
- 8) Cover the through-holes with sealing materials to prevent the water, dust or small animals going into the outdoor unit.

<b>⚠ CAUTION</b>	
1)	The transmission line and the power cable must be separated with an interval of at least 2cm (3/4inch); otherwise it may be result in communication problem.
2)	In order to protect the power cable and transmission line from damaging by the knockout hole, the rubber ring must be placed on the hole. Otherwise, it may cause electrical shock or fire etc.
3)	The power wire and transmission line must be more than 1 meter (3-1/4feet) away from televisions or radios which can emit electromagnetic waves to prevent image interference or noise. Otherwise, the unit maybe cannot work.
4)	Confirm the each cable connected to the terminal screw is exactly and securely after finishing the electric work.
5)	Fix each ground wire separately with the ground screw.
6)	If the connecting wire is connected to the terminal incorrectly, it may cause a fire.

## 8 Design of Drainage Pipeline

### 8.1 Installation of Drain Hose

- 1) Choose one drain hole in the bottom of the outdoor unit.
- 2) Connect the drain hose to the drain hole.
- 3) The drain hose should be kept at 5~10 degrees of gradient to facilitate discharge of the condensing water. Take care that does not exert too much force on the hose.
- 4) Thermal insulation materials should be placed at the joints of the drain hose so as to prevent from dew condensation. Fix the drain hose firmly by binding band.

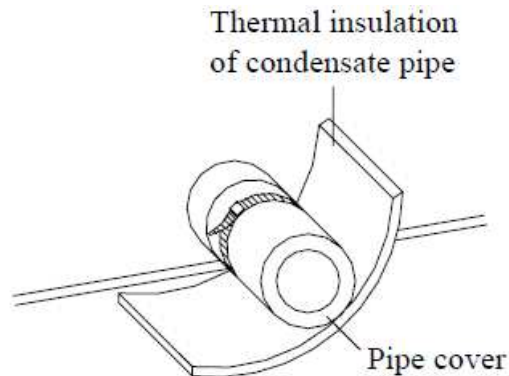

Fig. 22

- 5) The end of the drain hose should be inserted into the hole of drainage pipeline.

### 8.2 Design of Drainage Pipeline

- 1) The drainage pipeline should be kept at a certain gradient ( $1/50$ — $1/100$ ) so as to avoid bulges of pipes where there might be water bends.
- 2) The drainage pipeline is form of the hard PVC pipes for common purposes which can be purchased locally. The diameter of the PVC pipes is not less than 17mm ( $11/16$ inch) and the pipeline should be fixed as close to the BU module as possible.
- 3) Insert the drain hose into the drain hole of drainage pipeline. Use binding band to fix it tightly. It is not allowed to use adhesive glue to join the drain hose to the drainage hole.
- 4) When the drainage pipeline is laid for a couple of units, the position of the shared pipeline should be approximately 100mm lower than the drainage hole of each module. In this case, some special-purpose pipes with thicker walls will be used.

**NOTICE!** At intervals of about 1 meter (3-1/4feet), fix the drain pipes to the wall with brackets, not floating in the air.

## 9 Installation of Protective Layer

- 1) The refrigerant pipes should be insulated by the heat insulation material and plastic tape in order to prevent water condensation and leakage.
- 2) Do not use the foam on the branch pipe as the material for heat insulation, heat insulation material of branches should be the same as that of the pipeline.

**NOTICE! The heat resistance of heat insulation material should be over than 120°C(248°F) and its thickness is more than 9mm(3/8inch).**

- 3) The joints of the system should be wrapped with the heat insulation material and no gap is allowed on the joint of the system, as shown in the following figure.

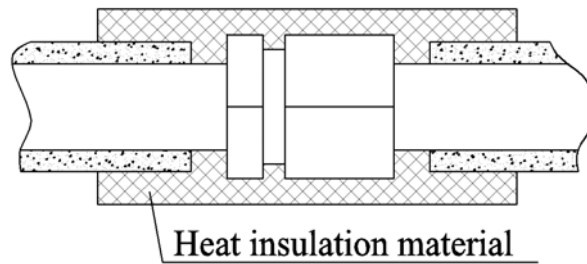

Fig. 23

- 4) Bundle the refrigerant pipe and transmission line together with tape, and separate them from the drain pipe to prevent the condensate water overflowing.
- 5) Wrap the pipe from the bottom of the outdoor unit to the top of the pipe where it enters the wall. During the wrapping, the later circle should cover half of the former one.

### ⚠ CAUTION

- 1) At intervals of about 1 meter (3-1/4feet), fix the refrigerant pipes to the wall with brackets, that is, don't let the unit withstand the weight of it or float it in the air.
- 2) After the pipe is protected well enough, never bend it to form a small angle( $<90^\circ$ ), otherwise it would crack or break.
- 3) Do not wrap the refrigerant pipes very tight, otherwise the insulation effect would be weakened. Additionally, make sure the drain hose is separated from the refrigerant pipes.
- 4) After that, cover the hole on the wall with sealing materials to prevent wind and noise going into the room.

## 10 Test Operation

### 10.1 Check after Installation

Table 10

Items to be checked	Possible malfunction
Has it been fixed reliable?	The unit may drop, vibrate or make noise.
Has the gas leakage been checked?	It may cause insufficient cooling(heating) capacity.
Is the thermal insulation of the unit sufficient?	It may cause condensation and dripping.
Is the drainage well?	It may cause condensation and dripping.
Is the voltage in accordance with the rated voltage marked on the nameplate?	It may cause electric malfunction or the components may be burned out
Are the lines and pipelines correctly installed?	It may cause electric malfunction or the components may be burned out
Has the unit been safely grounded?	It may cause electrical leakage.
Are the models of lines in conformity with requirements?	It may cause electric malfunction or the components may be burned out
Are there any obstacles near the air inlet and outlet of the indoor and outdoor units?	It may cause insufficient cooling(heating) capacity.
Have the length of connection pipes and refrigerant charge amount been recorded?	It is not easy to decide the charge amount of refrigerant.

### 10.2 Test Operation

#### 1) Before test operation

- ◆ The appearance of the unit and the refrigerant pipes cannot be damaged during the installation.
- ◆ Do not switch on power before installation is finished completely.
- ◆ Electrical wiring must be connected correctly and securely.
- ◆ The stop valves of the outdoor unit should be opened fully.
- ◆ All the impurities such as scraps and thrums must be cleared from the unit.

#### 2) Test operation method

- ① The test operation should be carried out by the professionally skilled personnel on the premise that all items listed above are in normal conditions.
- ② Set the status of the power supply switch as “ON” eight hours before the start of operation
- ③ Press mode button, to select the COOL, or HEAT. Whether the air conditioner is work normally or not.
  - ◆ The fan motor of the indoor unit will run automatically in one minute.
  - ◆ The fan motor and compressor of the outdoor unit will run automatically in one minute.
- ④ Make sure that every combination of indoor units can work well.

### **WARNING**

If the unit cannot work nor has any abnormal noise after the compressor is started, turn off the unit for an immediate check.

## 11 Testing Board Introduction

### 11.1 Compose of the Testing Board

The testing board is in front of electrical box and can be observed well. It has several following advantages: detect indoor unit numbers and indoor unit address, displays real running function and error code automatically. It is composed of the function section, data section and button section.

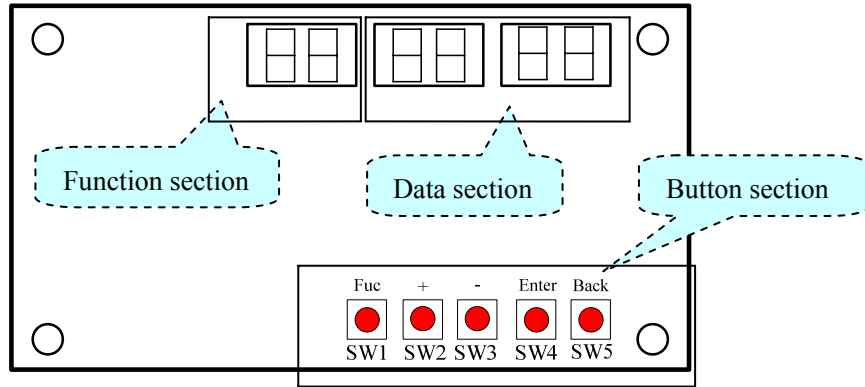

### 11.2 Instruction of Function and Data Section

Running state	The display of function section	The display of data section																
Stop	<p>① The section will display the numbers of the indoor units which have established communication with the outdoor unit. For example, if there are seven established indoor units, the section will display “7”.</p> <p>② It will display the address of the indoor units by turns. For example, the “1b” is represented of the indoor unit 1B. (BU module:1/2/3, Indoor unit: A/b/C/d/E)</p>	<p>① If the function section displays the numbers of the indoor units, the data section will display the outside temperature. For example, the “35” is represented of 35°C.</p> <p>② If the function section displays the address of the indoor unit, the data section will display the model of the indoor unit, for example, the “35” is represented of 35 model.</p>																
Normal	<p>The code of running state:</p> <table border="1" style="margin-left: auto; margin-right: auto;"> <thead> <tr> <th>Code</th> <th>Running state</th> <th>Code</th> <th>Running state</th> </tr> </thead> <tbody> <tr> <td>UE</td> <td>Pressure equalization</td> <td>UH</td> <td>Heating</td> </tr> <tr> <td>UP</td> <td>Pump down</td> <td>F7</td> <td>Oil returning</td> </tr> <tr> <td>UC</td> <td>Cooling</td> <td>H1</td> <td>Defrosting</td> </tr> </tbody> </table>	Code	Running state	Code	Running state	UE	Pressure equalization	UH	Heating	UP	Pump down	F7	Oil returning	UC	Cooling	H1	Defrosting	<p>It displays the target gear of the compressor. If the gear is zero, it will display “0”. For example, the gear is the fifteenth; it will display “15”. The range of the gear is from 0 to 60.</p>
Code	Running state	Code	Running state															
UE	Pressure equalization	UH	Heating															
UP	Pump down	F7	Oil returning															
UC	Cooling	H1	Defrosting															
Malfunction	<p>If the malfunction occurs in the system, the section will display the error code. If there are several malfunctions, it will display the error codes by turns at intervals of 2 seconds.</p>	<p>① If the malfunction occurs in the outdoor unit, the section displays nothing;</p> <p>② If the malfunction occurs in the indoor units, the section displays the address of the indoor unit.</p>																

## 12 Troubleshooting

<b>⚠ WARNING</b>	
1)	In the event of abnormal conditions (like, stinky smell), please shut off the power supply immediately and then contact the appointed service center; otherwise, the abnormal running would damage the air conditioner and also would cause electric shock or fire hazard .
2)	Do not repair the air conditioning personally but instead contact the professionally skilled personnel at the appointed service center, as the incorrect repair would cause electric shock or fire hazard etc.

### 12.1 Check before Contacting Service Center

Please check the following items before contacting the maintenance serviceman.

Conditions	Causes	Corrective actions
The unit does not run at all	Broken fuse or breaker is off	Replace the damaged fuse or close the breaker
	Power off	Restart the unit after power supply resumes
	Power supply plug is loose	Plug the power supply properly
	The batteries voltage of the remote controller is insufficient	Replace with new batteries
	Remote controller is out of the control scope	The distance shall be within 8m
The unit stops soon after it starts	Air inlet or outlet of indoor unit or outdoor unit is blocked	Remove the obstacles
Cooling or heating is abnormal	Air inlet or outlet of indoor unit or outdoor unit is blocked	Remove the obstacles
	Temperature setting is improper	Adjust the setting of remote controller or wire controller
	Air speed is set too low	Adjust the setting of remote controller or wire controller
	Improper airflow direction	Adjust the setting of remote controller or wire controller
	Door or window is open	Close the door or window
	Under direct sunshine	Hang curtain or blinders over the window
	Too many people in the room	
	Too many heat sources indoors	Reduce the heat sources
The filter screen is dirt or blocked	Clean the filter screen	

**NOTICE!** If the air conditioner still runs abnormally after the above check and handling, please contact the local appointed service center and also give a description of the error occurred as well as the model of the unit.

## 12.2 Problem Handling

The conditions listed below are not classified into errors.

Conditions		Causes
The unit does not run	When restart the unit soon after it is stopped	The overload protection switch of the unit let the startup delayed for three minutes
	As soon as power supply is on	The unit will stand by for approximate one minute
The unit blows out mist	When the cooling operation starts	The hi-humidity air indoor is cooled quickly
The unit generates noise	The unit “clatters” as soon as it starts running	It is the sound generated during the initialization of the electronic expansion valve
	The unit “swishes” during the cooling operation	It is the sound when the refrigerant gas runs inside the unit
	The unit “swishes” when it is started or stopped	It is the sound when the refrigerant gas stops running
	The unit “swishes” when it is in and after the running	It is the sound when the draining system is operating
	The unit “squeaks” when it is in and after the running	It is the sound of friction generated by the skin plate etc which swells due to the temperature change
The unit blows out dust	When the unit restarts after it is not used for a long time	The dust inside the unit is blown out again
The unit emits odors	When the unit is running	The odors absorbed in are blown out

## 12.3 Error Description

If some error occurs when the unit is running, the error code will be displayed and check for more details about the meaning of each error.

Errors of definition	Main control display for outdoor unit			Indoor unit code	Testing board code
	Yellow LED	Red LED	Green LED		
The compressor is startup	Flash 1 time				
IPM current protection	Flash 3 times			H5	H5
IPM temperature protection	Flash 5 times			P8	P8
PFC current protection	Flash 7 times				HC
PFC temperature protection	Flash 8 times			P8	P8
Low voltage protection	Flash 9 times			PL	PL
High voltage protection	Flash 10 times			PH	PH
Low pressure protection	Flash 11 times				E3
High pressure protection	Flash 12 times				E8
High pressure switch protection	Flash 13 times				E1
Capacitor charging error	Flash 14 times				PU
AC current protection	Flash 15 times			E5	E5

Memory card error	Flash 16 times				EE
Compressor demagnetizing protection	Flash 17 times			HE	HE
Compressor desynchronizing	Flash 18 times			H7	H7
Compressor phase lack	Flash 19 times			U2	U2
Compressor phase circuit detection error	Flash 20 times			U1	U1
Compressor power protection	Flash 21 times			L9	L9
Compressor overload protection	Flash 22 times			H3	H3
Compressor discharge temperature protection	Flash 23 times			E4	E4
Lack of refrigerant or jam protection	Flash 31 times			F0	F0
Normal operation		Flash 1 time			
Frequency limitation for AC current		Flash 2 times			F8
Oil returning		Flash 3 times			F7
Defrosting		Flash 4 times		H1	H1
Frequency limitation for IPM temperature		Flash 5 times			EU
Frequency limitation for PFC temperature		Flash 6 times			EU
Frequency limitation for compressor overload		Flash 8 times			LU
Frequency limitation for compressor discharge temperature		Flash 9 times			F9
Frequency limitation for low pressure		Flash 10 times			Pn
Frequency limitation for high pressure		Flash 11 times			F6
Discharge temperature sensor error		Flash 12 times		F5	F5
Outdoor temperature sensor error		Flash 13 times		F3	F3
Suction temperature sensor error		Flash 15 times			dc
Condenser temperature sensor error		Flash 16 times		A7	A7
Sub-cool temperature sensor error		Flash 17 times			bC
Low pressure sensor error		Flash 18 times			dL
High pressure sensor error		Flash 19 times			e1
Fan motor error for indoor unit		Flash 20 times		H6	H6
Driving board is connected			Flash 1 time		
Testing board is connected			Flash 2 times		
Computer is connected			Flash 4 times		
Indoor unit 1 is connected			Flash 5 times		
Indoor unit 2 is connected			Flash 6 times		
Indoor unit 3 is connected			Flash 7 times		
Indoor unit 4 is connected			Flash 8 times		
Indoor unit 5 is connected			Flash 9 times		

Indoor unit 6 is connected			Flash 10 times		
Indoor unit 7 is connected			Flash 11 times		
Indoor unit 8 is connected			Flash 12 times		
Indoor unit 9 is connected			Flash 13 times		
Indoor unit anti-freeze protection				E2	E2
Indoor temperature sensor error				F1	F1
Indoor evaporator midway temperature sensor error				F2	F2
Temperature sensor error for liquid pipe of BU module				b5	b5
Temperature sensor error for gas pipe of BU module				b7	b7
Running mode conflicts				E7	E7
Communication error				E6	E6 indoor unit address
Communication error between the main board and driving board					P6
Communication error between the main board and testing board					CE
Gas sensor error of indoor unit					Fn
Humidity sensor error of indoor unit					L1
Water full error of indoor unit				E9	E9
Jumper terminal error of indoor unit				C5	C5
Phase lack of power supply					dJ
Fan motor error of outdoor unit					L3
Refrigerant recovery mode				Fo	Fo

- ◆ Display mode of Red LED and Yellow LED: At intervals of half a second, flash for half a second; if there are several malfunctions, it will display the error codes by turns at intervals of one second.
- ◆ Display mode of Green LED: At intervals of 1/4 second, flash for 1/4 second; and it displays the running states by turns at intervals of half a second.

## 13 Maintenance

Check, maintenance and care regularly should be performed by professional personnel, which will prolong the unit service life.

### 13.1 Outdoor Condenser

Outdoor condenser is required to be cleaned every two months. Use vacuum cleaner with nylon brush to clean up dust and sundries on the surface of condenser. Blow away dust by compressed air if it is available. Never use water to wash the condenser.

### 13.2 Drain Pipe

In order to drain condensate smoothly, please check the drain pipe regularly is clogged or not.

### 13.3 Check before the Seasonal Use

- ◆ Check the air inlet and outlet of the indoor and outdoor units to confirm there is no blockage.
- ◆ Check the ground wire to confirm the grounding is reliable.
- ◆ Check the batteries of the wireless remote controller to ensure that they have been replaced.
- ◆ Check the filter screen that it has been set soundly.
- ◆ If the air-conditioning unit shall be operated again after a long-term shut off, set the status of the power supply switch as “ON” eight hours before the start of operation, so as to ensure the successful startup of the air-conditioning unit.
- ◆ Check the outdoor unit to ensure the installation of it is steady. Contact the appointed service center if there is any abnormal condition.

### 13.4 Maintenance after Seasonal Use

- ◆ Turn off the power supply of the air conditioning unit and set the status of the power supply switch as “OFF”.
- ◆ Clean the filter screen and the housing of the indoor and outdoor units.
- ◆ Remove the dust and the foreign matters of the outdoor unit.
- ◆ In the event of rusting, please use the anti-rust paint to stop spreading of rust.

Refer to the *Installation and Operation Manual* of each indoor unit respectively for detailed maintenance.

## 14 After-sales Service

If the unit cannot work or has any problem, please contact the local after-sales service agency designated by Impecca.

Warranty should meet the following requirements:

- ① The installation and test operation of the unit should be operated by professional personnel from appointed service center.
- ② Only Impecca manufactured accessories can be used on the machine.
- ③ All the instructions listed in this manual should be followed.
- ④ Warranty will be automatically invalid if fails to obey any item mentioned above.

## 15 CUSTOMER SUPPORT

Before contacting customer support, please see the troubleshooting guide above.

Visit our website to contact us, find answers to Frequently Asked Questions, and for other resources which may include an updated version of this user's guide.

 [WWW.IMPECCA.COM](http://WWW.IMPECCA.COM)

If you wish to contact us by phone, please be sure to have your model number and serial number ready and call us between 9:00am and 6:00pm ET, at +1 866-954-4440.

Keep tabs on Impecca's newest innovations & enter contests via our social network feeds:

 [www.facebook.com/Impecca/](http://www.facebook.com/Impecca/)

 [www.instagram.com/impecca/](http://www.instagram.com/impecca/)

 [@impeccausa](https://twitter.com/impeccausa)





**Flex+**  
**R410A Systems—BU**  
**modules:**

**IS-BU12**

**IS-BU13**

**IS-BU15**

**Owner's Manual**  
**Air Conditioners**



## Preface

Flex+ Series adopt the advanced manufacturing technology and takes the environmental-friendly R410A as refrigerant, which is a green product in the 21st century. Please carefully read the manual before installation and operation.

- 1) Flex+ Series systems conform to design standard ARI 210240-2008.
- 2) To ensure safety when operating this system, please strictly follow the instructions in this manual.
- 3) Make sure that the manual is kept by the operators or serviceman.
- 4) The refrigerant pipes and accessories must be designed exclusively for R410A.
- 5) The total capacity of the indoor units which runs at the same time cannot exceed the capacity of the outdoor units; otherwise, the cooling (heating) effect of each indoor unit would be lower than the nominal capacity.
- 6) In case of malfunction, please examine the following items and contact our appointed service centers as soon as possible.
  - ◆ Nameplate (model, cooling capacity, product code, ex-factory date).
  - ◆ Malfunction status (detail description of conditions before and after malfunction occurs).
- 7) It is a normal phenomenon that the fan of indoor unit will still run for 20-70 seconds after the indoor unit receives the “stop” signal so as to make full use of the waste heat.
- 8) When the work mode of the indoors is conflict with the modes of outdoor units, it will be indicated on the display of the wired controller in five seconds and then the indoor unit will stop. In this case, please harmonize their work modes: the cooling mode is compatible with the dry mode.
- 9) If the supply power fails when the unit is running, then the indoor unit will send the “start” signal to the outdoor unit three minutes later after the power recovery.
- 10) The power cable and transmission line must not be twisted together, but instead of separated with an interval of at least 2cm; otherwise it may be result in communication problem.
- 11) This appliance is not intended for use by persons (including children) with reduced physical, sensory or mental capabilities, or lack of experience and knowledge, unless they have been given supervision or instruction concerning use of the appliance by a person responsible for their safety. Children should be supervised to ensure that they do not play with the appliance.
- 12) All graphics and information in this manual are only for reference. Manufacturer reserves the right for changes in terms of sales or production at any time and without prior notice.



This product must not be disposed together with the domestic waste. This product has to be disposed at an authorized place for recycling of electrical and electronic appliances.



**Thank you for purchasing Impecca air conditioners. Before using, please read this manual carefully and keep it properly for further reference.**

# Contents

1	Safety Precautions.....	1
2	Product Introduction .....	3
2.1	Names of Main Parts.....	3
2.2	Combinations for Outdoor and Indoor Units .....	4
2.3	Parts and Components of Unit .....	4
2.4	Working Temperature Range .....	4
3	Selection of Installation Location and Precautions.....	5
3.1	Selection of Installation Location .....	5
3.2	Outline Dimension and Servicing Space of IS-BU12 .....	6
3.3	Outline Dimension and Servicing Space of IS-BU13 .....	7
3.6	Outline Dimension and Servicing Space of IS-BU15 .....	10
4	Installation Instruction .....	11
5	Installation of Refrigerant Pipes .....	12
5.1	Allowable Length and Drop Height of Connecting Pipe .....	12
5.2	Installation of Piping Adapter (IS-BU12 IS-BU13 and IS-BU15).....	12
5.4	Precaution for Connection .....	15
6	Electrical Wiring Work .....	17
6.1	Wiring Connection.....	17
6.2	Requirements of Power Circuit and Cable.....	17
6.3	Ground Requirements .....	18
6.4	Precautions on the Electrical Wiring Work .....	18
6.5	Precaution of Laying Wires.....	19
6.6	Procedures for Electrical Wiring Work .....	19
6.7	Instructions for DIP Switch.....	21
7	Design of Drainage Pipeline .....	22
7.1	Installation of Drain Hose .....	22
7.2	Design of Drainage Pipeline .....	22
8	Test Operation.....	22
9	Troubleshooting .....	23
10	After-Sales Service .....	23



## 1 Safety Precautions

	This is the safety alert symbol. It is used to alert you to potential personal injury hazards. Obey all safety messages that follow this symbol to avoid possible injury or death.
 <b>WARNING</b>	This mark indicates procedures which, if improperly performed, might lead to the death or serious injury of the user.
 <b>CAUTION</b>	This mark indicates procedures which, if improperly performed, might possibly result in personal harm to the user, or damage to property.
<b>NOTICE</b>	NOTICE is used to address practices not related to personal injury.

 <b>WARNING</b>	
1)	Instructions for installation and use of this product are provided by the manufacturer.
2)	Installation must be performed in accordance with the requirements of NEC and CEC by appointed personnel only.
3)	The installation should be left to the appointed service center and according to the instructions given in the manual. Improper installation may cause fall down, water leakage, electric shock or fire etc.
4)	For operating the air conditioner pleasantly, please install it as outlined in this installation manual.
5)	The power supply must adopt the special circuit with air switch protection and assure it has enough capacity
6)	Connect the indoor unit, BU module and outdoor unit with the room air conditioner piping and cord available from our standard parts. This installation manual describes the correct connections using the installation set available from our standard parts.
7)	Before installation, check the parameter of power cord and make sure that it complies with the power supply requirement on the nameplate. Make sure the power supply is safe.
8)	This air conditioner must be properly grounded through the receptacle to avoid electric shock. The ground wire shouldn't be connected with gas pipe, water pipe, lightning arrester or telephone line.
9)	If refrigerant leaks while work is being carried out, ventilate the area. If the refrigerant comes in contact with a flame, it produces toxic gas.
10)	Do not power on until all installation work is complete.
11)	During installation, make sure that the refrigerant pipe is attached firmly before you start up the compressor. Do not operate the compressor under the condition of refrigerant piping not attached properly with valve open. This may cause abnormal pressure in the refrigeration cycle that leads to breakage and even injury.
12)	When installing and relocating the air conditioner, do not mix gases except the specified refrigerant (R410A) to enter the refrigerant cycle. If air or other gas enters the refrigerant cycle, the pressure inside the cycle will rise to an abnormally high value and cause breakage, injury, etc.
13)	This appliance is not intended for use by persons (including children) with reduced physical, sensory or mental capabilities, or lack of experience and knowledge, unless they have been given supervision or instruction concerning use of the appliance by a person responsible for their safety. Children should be supervised to ensure that they do not play with the appliance.
14)	Never cut off or damage power cables and transmission wires. If the power cable or transmission line were damaged, it must be replaced by the manufacturer, its service agent or similarly qualified persons in order to avoid a hazard.
15)	After the power cord is connected, please install the cover of electric box to avoid danger.

16) When installing or relocating the unit, please contact the appointed service center for the repair or relocation. Meanwhile the specialized parts and accessories must be used. Otherwise, it may result in water leakage, electric shock or fire hazard.
17) Diameter of power cord must be large enough. Damaged power cord or connecting wire must be replaced by specialized electric cable.
18) The power wire and transmission line must be more than one meter away from televisions or radios which can emit electromagnetic waves to prevent image interference or noise. Otherwise, the unit maybe not work
19) Nitrogen must be charged according to technical requirements.
20) For units with wired controllers, do not connect power supply until the wired controller is well installed. Otherwise, the wired controller cannot be used.
21) When installation is finished, please check and make sure the drain pipe, pipeline and electric wire are all well connected so as to avoid water leakage, refrigerant leakage, electric shock and fire hazard.
22) Never extend fingers or objects into air outlet or return air grille.
23) Please keep the room well-ventilated and it could avoid oxygen deficit.
24) Never start or stop the air conditioner by inserting or removing the power cord.
25) Before startup of the compressor, please turn on the main power switch of the unit for more than 8 hours and it makes sure that the heater belt of the compressor has been energized for at least eight hours! Once the compressor is started, it must be guaranteed that it works continuously for at least 30 minutes, otherwise it would be damaged!
26) Never operate the unit with wet hands. Otherwise, it may cause electric shock.
27) Before cleaning and repairing, it is necessary to stop working and turn off the power supply. Otherwise, it may cause electric shock or damage.
28) Do not spray water on the air conditioner or it will cause malfunction or electric shock.
29) The air conditioner is not support to install in the circumstances as the following that where there is full of mist of oil, damp or corrosive gas, flammable gases, the acidic or alkaline vapor and the ocean.
30) Volatile liquid like thinner or gasoline will damage the appearance of air conditioner. (Please use soft dry cloth and wet cloth with mild detergent to clean unit's appearance.)
31) Never standing or place objects on outdoor unit. Person or objects falling from the unit may cause injury.
32) If abnormal condition occurs (e.g. unpleasant smell), please turn off the unit at once and disconnect power supply. Then contact appointed service center. If the air conditioner continues to operate despite of abnormal condition, it may be damaged and cause electric shock or fire hazard.
33) The drain pipe should be installed as instructed in the manual to guarantee the proper drainage; meanwhile it should be insulated to prevent condensing; otherwise the improper installation would cause water leakage and then wet the household wares in the room.
34) Don't attempt to repair the air conditioner by yourself. The improper repair will lead to electric shock or fire, please contact the appointed service center and ask professional technicians to repair it.
35) Please take notice of the installation foundation of the unit after long use, if it is damaged, it may lead to the fall of the unit and cause the injury.
36) Be sure to shut off the power supply when you do not use the air conditioner for a long time. Otherwise, the dusts may accumulate in it, which may cause overheating or fire hazards.
37) Impecca Electric Appliances, Inc. of Zhuhai is not responsible for any personal injury or property loss caused by improper installation, improper debugging, unnecessary repair or not following the instructions of this manual.

## 2 Product Introduction

The BU module of Impecca Flex+ Series is the latest branch device, which adopts intelligent control technology. Responding to the changes in load of the indoor units, it can coordinate the flow rate of the refrigerant well. Otherwise, it is very compact and offers a flexible choice about the installation location, such as the ceiling of parlor, corridor, balcony, storeroom and etc.

### 2.1 Names of Main Parts

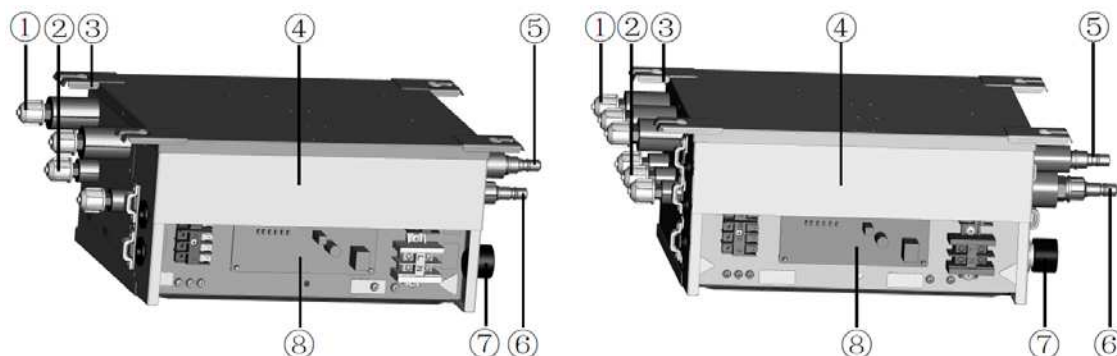

a) IS-BU12

b) IS-BU13

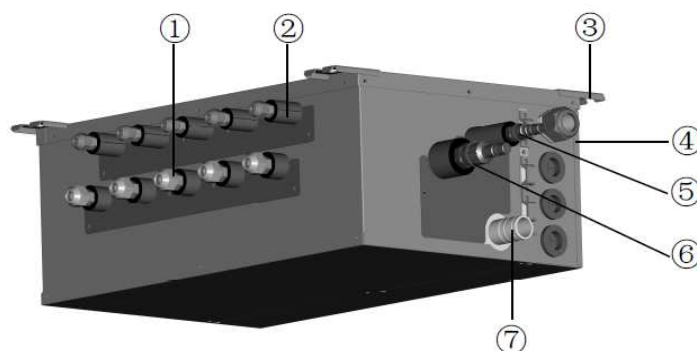

e) IS-BU15

NO.	①	②	③	④
Name	Gas piping of indoor unit side	Liquid piping of indoor unit side	Hanger metal	Electrical equipment plate
NO.	⑤	⑥	⑦	⑧
Name	Liquid piping of outdoor unit side	Gas piping of outdoor unit side	Drain hole	Printed circuit board

Fig. 1

## 2.2 Combinations for Outdoor and Indoor Units

Table 1

Sorts		IS-BU12	IS-BU13	IS-BU15
No. of connectable indoor units	Min	1	1	1
	Max	2	3	5

## 2.3 Parts and Components of Unit

For the Super Free Match Series, one outdoor unit is able to drive up to three BU modules and nine indoor units which include cassette type, duct type, wall-mounted type, floor ceiling type and console type. The outdoor unit will run as long as any one indoor unit receives the running command, and all indoor units stop once the outdoor unit is turned off.

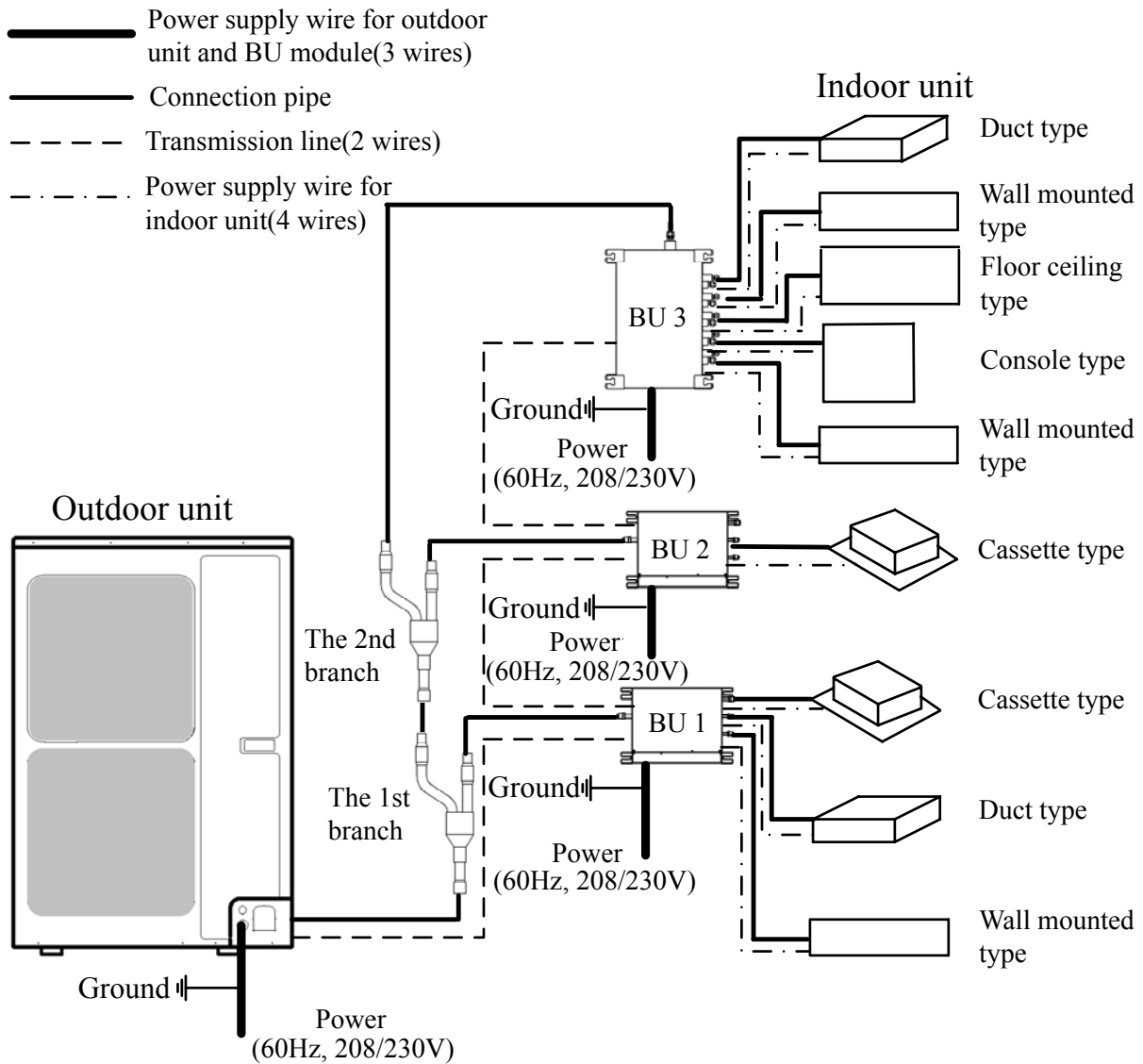

Fig. 2

## 2.4 Working Temperature Range

Table 2

Sorts	Outside temperature: DB(°C/°F)
Maximum	50°C(122°F)
Minimum	-15°C(5°F)



### 3 Selection of Installation Location and Precautions

<b>⚠ WARNING</b>	
1)	The installation of the air conditioner must be in accordance with the national and local laws and regulations.
2)	The quality of the installation will affect the capability of air conditioner directly. The installation should be left to the appointed service center. Please contact your dealer after purchasing this machine. Professional installation workers will provide installation and test services according to the installation manual.
3)	The air conditioner should not install in this place where the small animals exist, because they may cause malfunctions, smoke or fire. Please keep the area around the unit clean.

#### 3.1 Selection of Installation Location

<b>⚠ WARNING</b>	
1)	The BU module must be installed on a firm and solid support which can withstand the weight of the module and the mounting surface must be horizontal plane. The BU module can be chosen to install in the ceiling, such as the ceiling of parlor, corridor, balcony, storeroom and etc.
2)	The location must be out of children's reach, please keep the unit away from children.
3)	The BU module is for indoor use. If installing in the outdoors, the location must be away from wind and rain. Otherwise, it maybe causes water leakage, electric shocks or fire etc.
4)	There is enough space for the installation and maintenance.
5)	Avoid direct sunlight or other heat sources exist.
6)	Do not install in location that is hot or humid for long periods of time.
7)	Avoid the BU module installed in the bedroom and study, where these places need to be quiet.
8)	BU module cannot be installed in the place of inflammable and explosive materials and severe dust, smoke and the other air pollution, such as the kitchen.
9)	There is enough space to install drainage pipe, so that the condensed water can be discharged.
10)	Installation at the following places might lead to the air conditioner malfunction, such as where is full of machine oil, saline-sodic soil near the sea, sulphide fog, high frequency facilities or special conditions. If it is unavoidable, please contact the appointed service center.

<b>NOTICE</b>	
1)	Make sure that the unit will not cause any operating vibration or noise after installation.
2)	BU module shall be installed close to the indoor unit, hence to minimize the length and bends of cooling pipe.

### 3.2 Outline Dimension and Servicing Space of IS-BU12

1) Outline dimension

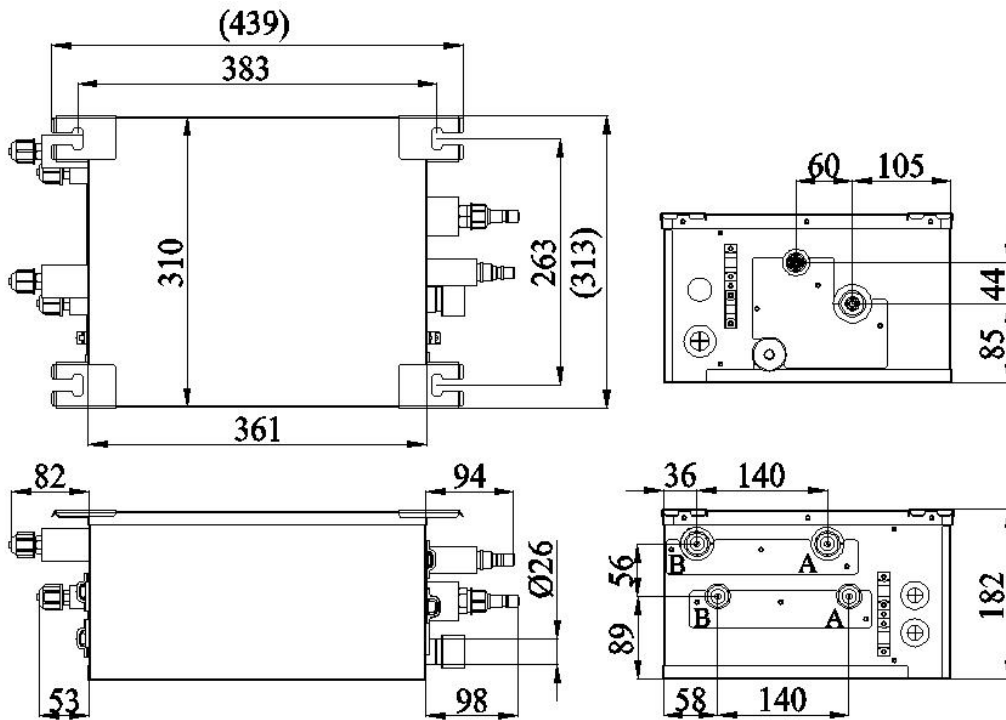
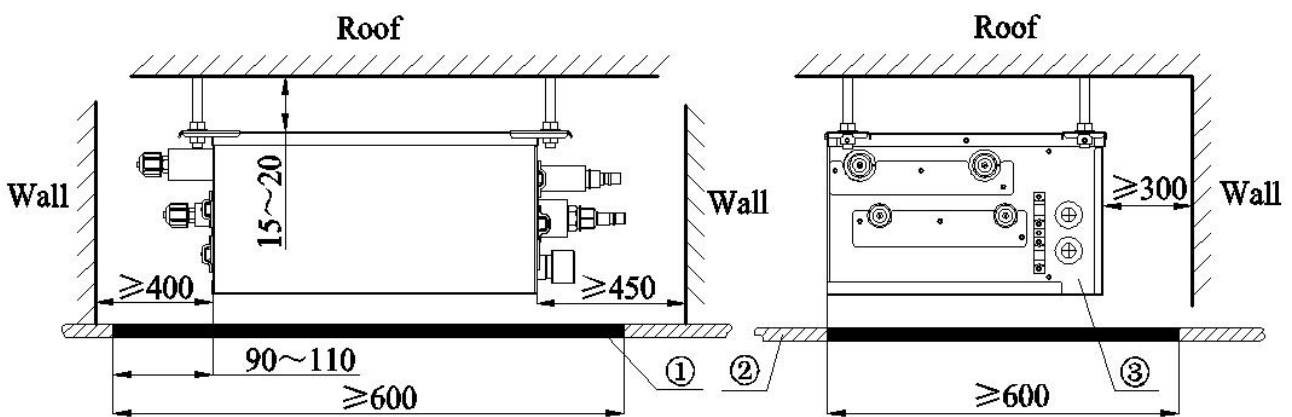

Fig. 3 (mm)

Table 3

Sorts	Indoor unit side (mm/inch)		Outdoor unit side (mm/inch)
	Port A	Port B	
Liquid pipe	Φ6.35(1/4)	Φ6.35(1/4)	Φ9.52(3/8)
Gas pipe	Φ9.52(3/8)	Φ9.52(3/8)	Φ15.9(5/8)

2) Installation and service space



NO.	①	②	③
Name	Servicing space	Ceiling	Electrical box side

Fig. 4 (mm)



### 3.3 Outline Dimension and Servicing Space of IS-BU13

1) Outline dimension

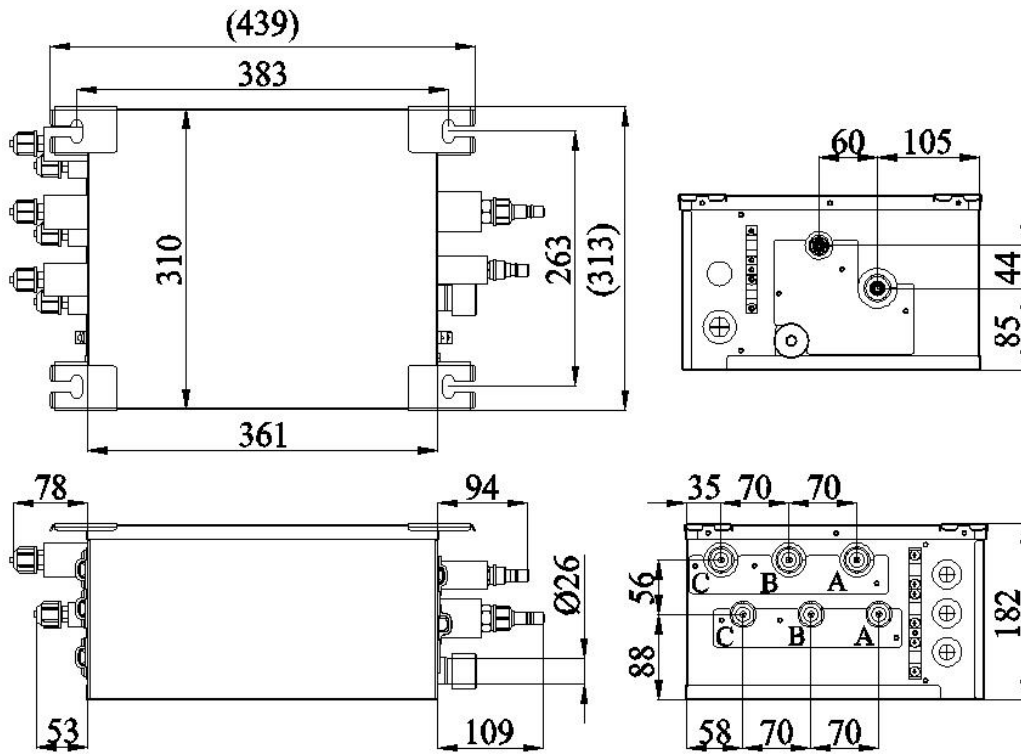
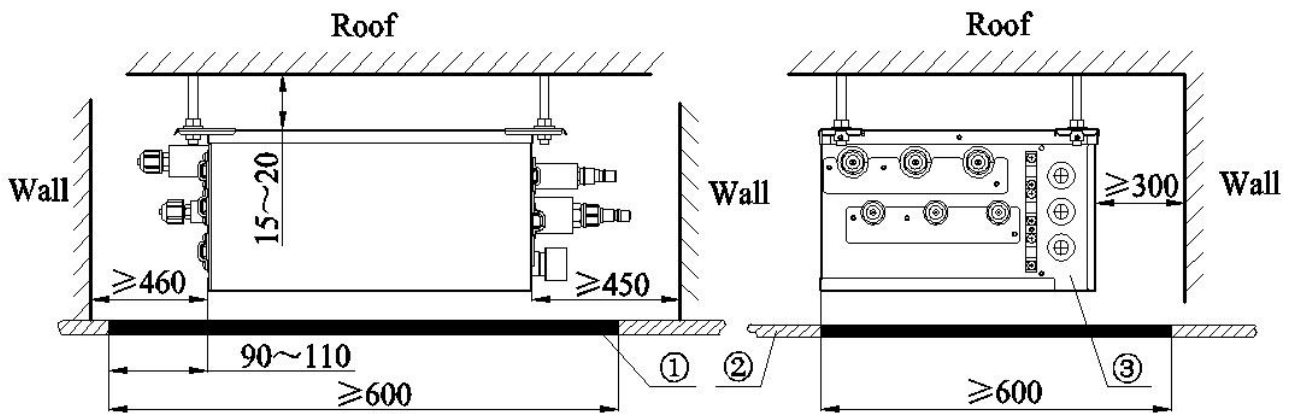

Fig. 5 (mm)

Table 4

Sorts	Indoor unit side (mm/inch)			Outdoor unit side (mm/inch)
	Port A	Port B	Port C	
Liquid pipe	Φ6.35(1/4)	Φ6.35(1/4)	Φ6.35(1/4)	Φ9.52(3/8)
Gas liquid	Φ9.52(3/8)	Φ9.52(3/8)	Φ9.52(3/8)	Φ15.9(5/8)

2) Installation and service space



NO.	①	②	③
Name	Servicing space	Ceiling	Electrical box side

Fig. 6 (mm)



### 3.6 Outline Dimension and Servicing Space of IS-BU15

1) Outline dimension

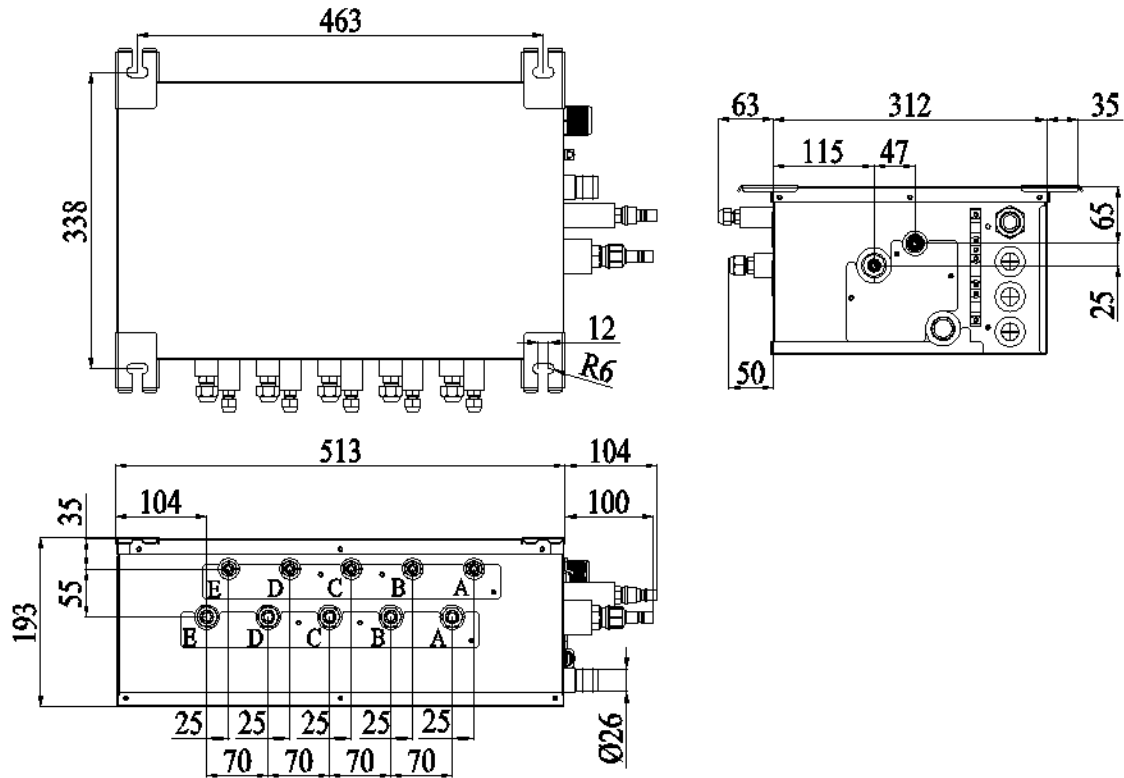
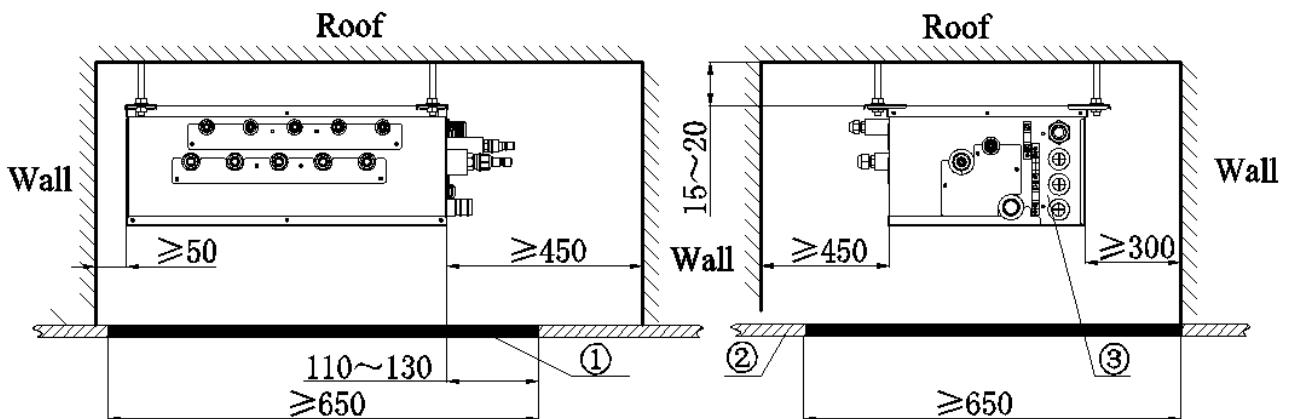

Fig. 11 (mm)

Table 7

Sorts	Indoor unit side (mm/inch)	Outdoor unit side (mm/inch)
Liquid pipe	Φ6.35(1/4)	Φ9.52(3/8)
Gas pipe	Φ9.52(3/8)	Φ15.9(5/8)

2) Installation and service space



NO.	①	②	③
Name	Servicing space	Ceiling	Electrical box side

Fig. 12 (mm)



## 4 Installation Instruction

- 1) Check the installation location and ensure it is strength and level. Otherwise, there should be enough space to install drainage pipe, so that the condensed water can be discharged.
- 2) Reference to the size of hanger metal and drill 4 holes in the installation location.
- 3) Hang the hanger bolts.

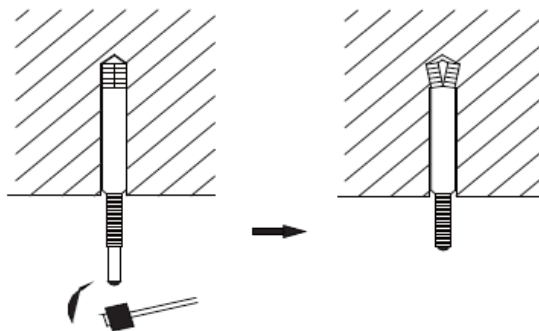

Fig. 13

- 4) Fix the modules securely with the hanger bolts. You can get the M10 or M8 hanger bolts, nuts and washers from the market.

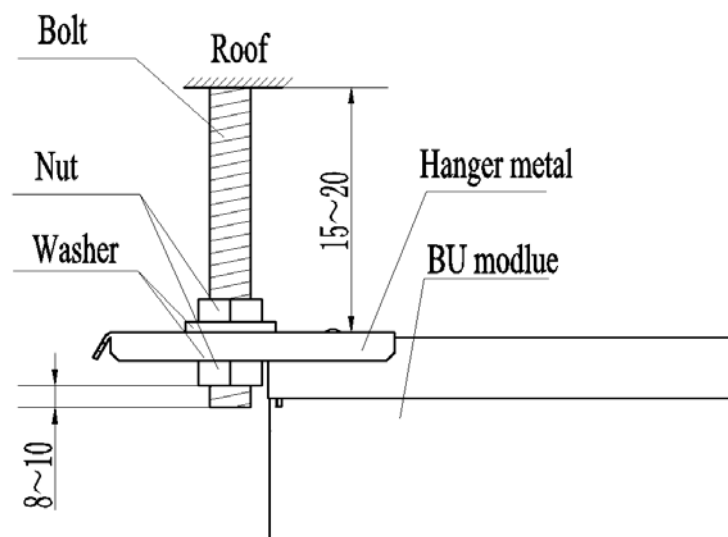

Fig. 14 (mm)

- 5) Adjusting the nuts position, so that the BU module should be level in front/back and left/right.

## 5 Installation of Refrigerant Pipes

### 5.1 Allowable Length and Drop Height of Connecting Pipe

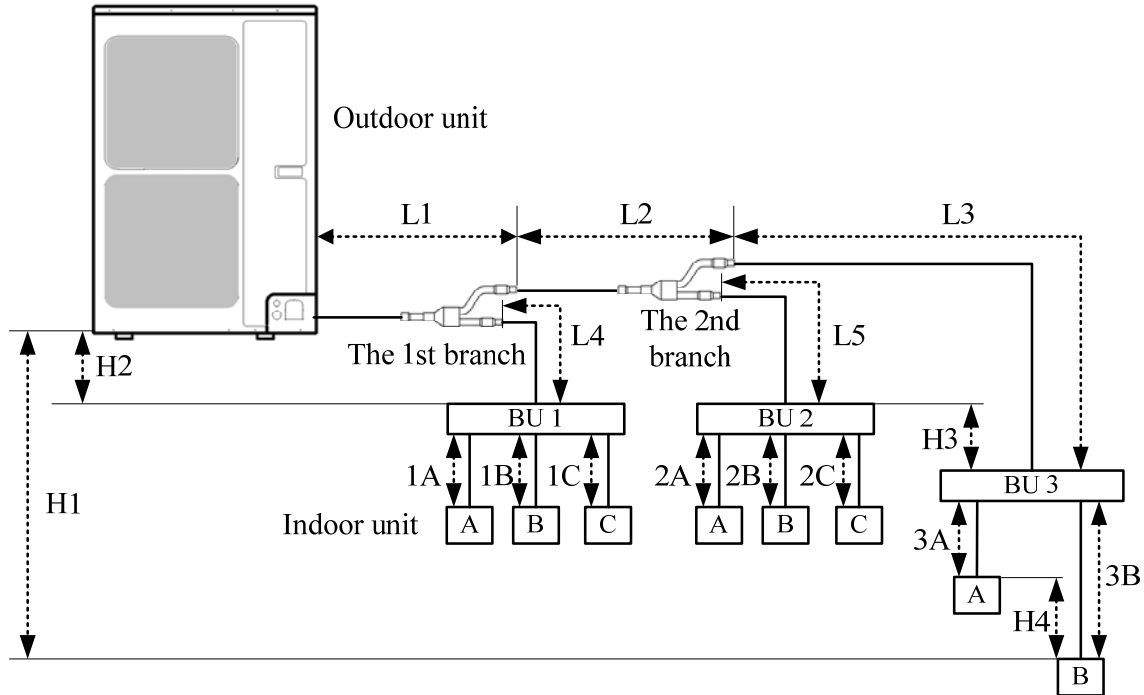

Fig. 15 (8 indoor units)

Table 8

The sorts		The pipes	Length(m/feet)
Maximum allowable length	Total length between outdoor unit and BU modules	$L1+L2+L3+L4+L5$	$\leq 55(181)$
	Total length between indoor units and BU	$1A+1B+1C+2A+2B+2C+3A+3B$	$\leq 90(295)$
	Between indoor unit and BU module	$1A;1B;1C;2A;2B;2C;3A;3B$	$\leq 15(49)$
	Between indoor unit and the 1st branch	$L4+1B;L2+L5+2A;L2+L3+3B$	$\leq 40(131)$
Maximum allowable length	Between outdoor and indoor units	H1	$\leq 30(99)$
	Between outdoor units and BU modules	H2	$\leq 30(99)$
	Between BU and BU modules	H3	$\leq 15(49)$
	Between indoor and indoor units	H4	$\leq 15(49)$
Minimum allowable length	Between outdoor and the 1st branch	L1	$\geq 5(16)$
	Between BU and the branch	$L3;L4;L5$	as possible as short

**NOTICE!** BU module should be placed within the level between the outdoor unit and indoor unit.

### 5.2 Installation of Piping Adapter (IS-BU12 IS-BU13 and IS-BU15)

If the piping connection size of BU module does not match with that of the outdoor unit and indoor units, it should prevail with the piping connection size of the outdoor unit and indoor units.



Install the optional piping adapters to the BU module, so that the piping connection size of BU module can match with that of the outdoor unit and indoor units.

1) Piping adapter(Optional accessories)

Table 9

NO.	Name	Port A (mm/inch)	Port B (mm/inch)
1	$\Phi 15.9 \rightarrow \Phi 19.05$	$\Phi 15.9(5/8)$	$\Phi 19.05(3/4)$
2	$\Phi 9.52 \rightarrow \Phi 12.7$	$\Phi 9.52(3/8)$	$\Phi 12.7(1/2)$
3	$\Phi 9.52 \rightarrow \Phi 15.9$	$\Phi 9.52(3/8)$	$\Phi 15.9(5/8)$
4	$\Phi 6.35 \rightarrow \Phi 9.52$	$\Phi 6.35(1/4)$	$\Phi 9.52(3/4)$

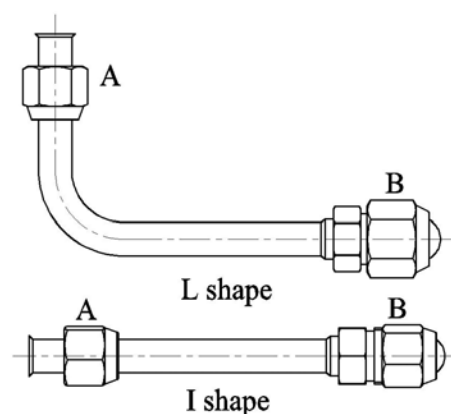

Fig. 16

2) Install the piping adapter

- ① Refer to the piping connection size of the outdoor unit and indoor units, the appropriate piping adapter should be adopted.
- ② Align the flared end of copper tube with the center of pipe joint. Tighten the nuts with hands. Then tighten the flaring nuts with torque wrench until you hear a “click”.

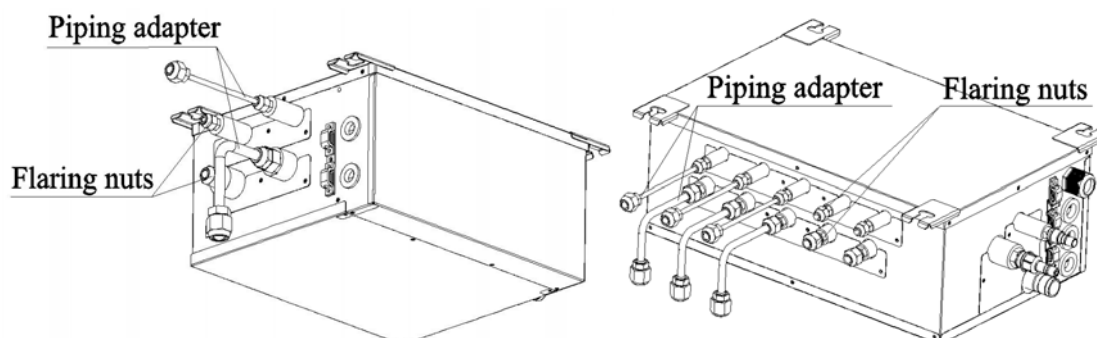

Fig. 17

3) Sealing the unconnected port

If the port of BU module indoor side does not connected to one indoor unit, the port must be sealed to prevent refrigerant leaks. Please tighten the copper flaring nuts to the unconnected port with torque wrench until you hear a “click”.

## 5.4 Precaution for Connection

### ⚠ CAUTION

- 1) Conform to the following principles during pipe connection: Outdoor unit shall be installed close to the indoor unit, hence to minimize the length and bends of connection pipes; the height gap of outdoor unit and indoor units should be as small as possible; the radius of curvature should be as large as possible.
- 2) The brazing operation must be strictly in accordance with the process requirements. Rosin joint or pin hole is not allowed.
- 3) During the installation, do not damage the pipeline. The pipeline's radius of bending must be over than 200mm (8inch). The pipes cannot repeatedly be bent or straightened. Otherwise it will get harden and crack. Do not bend or straight the pipes for more than 3 times at the same position.

- 1) The process of flaring
  - ① Using the tube cutter to cut the connecting pipe in the appropriate place and remove the burrs.
  - ② Install the nut before the flaring operation.
  - ③ Check the flared portion, whether there is fractured or not.

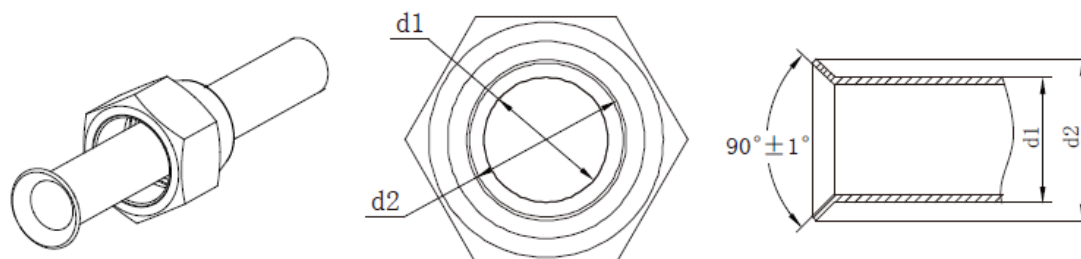

Fig. 21

- 2) Precaution for elbow operation
  - ① The elbow operation could be done by hands. Be careful and do not damage the pipe.

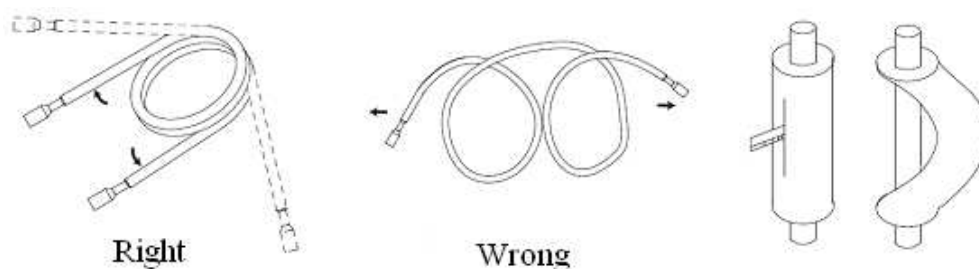

Fig. 22

- ② If the thermal insulation of the refrigerant pipe is not removed, please do not bend the pipe. Otherwise, it may lead the pipe to crack. It is better to make an incision with a knife in the thermal insulation and remove it. After elbow operation is finished, recover the thermal insulation with binding band.
- 3) The process of install refrigerant pipes
  - ① Remove the screw caps from the pipes.
  - ② Align the flared end of copper tube with the center of pipe joint. Tighten the nuts by hands. (If the flared end of copper tube and the center of pipe joint are not in coaxial, it is hard to tighten the nuts by hands, please do not tighten it with spanners, because the screw thread may be broken by force).
  - ③ Tighten the flaring nuts with torque wrench until you hear a “click”. (The spanner and torque wrench should be perpendicular to the refrigerant pipeline).
  - ④ The following table for the torque required to tighten the nuts.

Table 10

Pipe diameter (mm/inch)	Thickness of copper tube(mm/inch)	Tightening torque (N·m/lbf·ft)
Φ6.35(1/4)	≥0.8(1/32)	15~30(11~22)
Φ9.52(3/8)	≥0.8(1/32)	35~40(26~29)
Φ12.7(1/2)	≥0.8(1/32)	45~50(33~37)
Φ15.9(5/8)	≥1.0(1/25)	60~65(44~48)
Φ19.05(3/4)	≥1.0(1/25)	70~75(52~55)

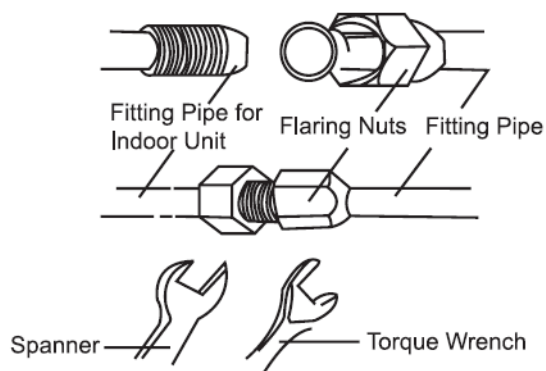
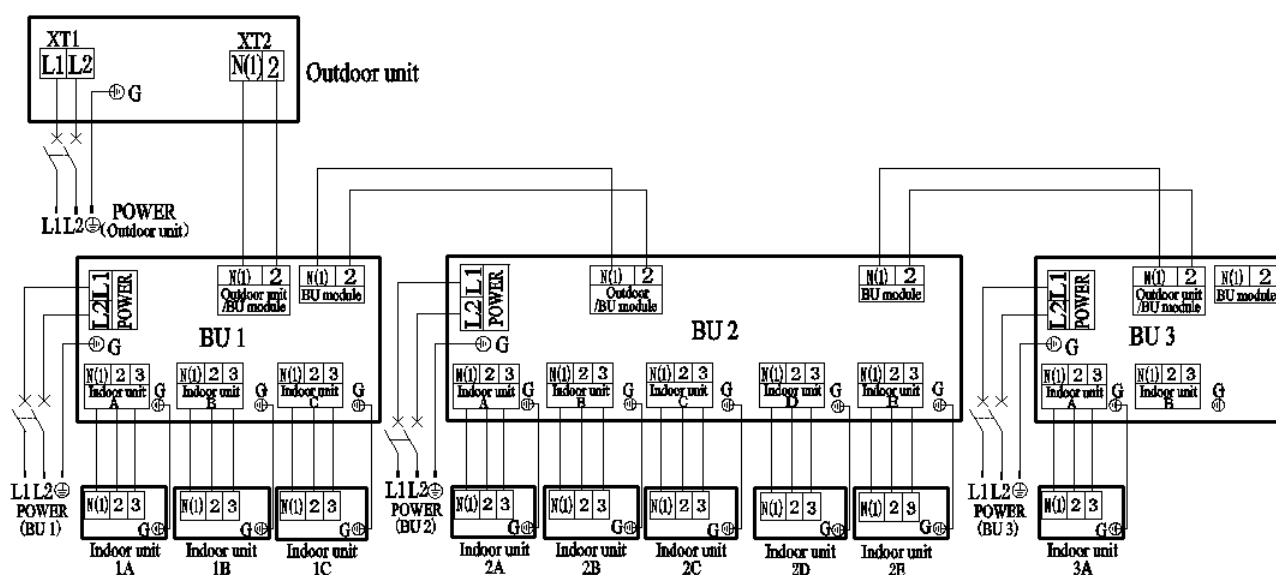

Fig. 23

<b>⚠ CAUTION</b>	
1)	During the connection of the indoor unit and BU module to the refrigerant pipe, never pull any joints of the indoor unit and the BU module by force; otherwise the capillary pipe or other pipe may crack, which then would result in leakage.
2)	The refrigerant pipe should be supported by brackets; that is, don't let the unit support its weight.
3)	For the Flex+ system, each pipe should be labeled to tell which system it belongs to avoid mistaken, inaccurate piping.

## 6 Electrical Wiring Work

### 6.1 Wiring Connection



**NOTICE!** The “L1”, “3” terminals are connected to the live wire, the “L2”, “N(1)” terminals are connected to the neutral wire and the ”2” terminal is connected to the transmission line.

Fig. 24

### 6.2 Requirements of Power Circuit and Cable

Table 11

Phase and frequency		1Ph,60Hz
Voltage		208/230V
Recommended cable of outdoor unit (Pieces × Sectional area)	ISMO-6021	3×6.0 mm <sup>2</sup>
Recommended cable of BU module (Pieces × Sectional area)		3×0.75 mm <sup>2</sup>
Transmission line (Pieces × Sectional area)		2×1.5 mm <sup>2</sup>
Recommended cable of indoor unit (Pieces × Sectional area)		4×0.75mm <sup>2</sup>
Capacity of the air switch	ISMO-6021	40A
	BU module	10A

### **NOTICE**

- 1) The total length of the transmission line between the outdoor unit and the furthest BU module is not more than 180 feet (55m). Otherwise, the system cannot work possibility.
- 2) The specifications of the power cable and transmission line listed in the table above are determined based on the maximum power (maximum amps) of the unit.
- 3) The specifications of the power cable listed in the table above are applied to the conduit-guarded

<p>multi-wire copper cable (like, YJV copper cable, consisting of PE insulated wires and a PVC cable jacket) used at 104°F (40°C) and resistible to 194°F (90°C), and shall be at least those of ordinary polychloroprene sheathed cords. If the working condition changes, they should be modified according to the related national standard.</p>
<p>4) The specifications of the air switch listed in the table above are applied to the breaker with the working temperature 104°F (40°C). If the working condition changes, they should be modified according to the related national standard.</p>
<p>5) The length of the recommended power cable should be less than 49 feet (15 meters); otherwise, the diameter of the power cable is not enough.</p>
<p>6) Written power cable and transmission line length is just a reference value. It may be different depending on the condition of installation, humidity or materials, etc.</p>
<p>7) An all-pole disconnection switch having a contact separation of at least 3mm (1/8 inch) in all poles should be connected in fixed wiring.</p>

### 6.3 Ground Requirements

<p><b>⚠ WARNING</b></p>
<p>1) The air conditioner is classified into the Class I appliances, so its ground ways must be reliable.</p>
<p>2) The ground wire must be fixed on the screw hole with the sign as the right figure. </p>
<p>3) The yellow-green wire of the air conditioner is the ground wire and must be fixed by the tapping screw. And it cannot be used for other purpose or cut off. Otherwise, it will cause the hazard of electric shock.</p>
<p>4) The reliable ground terminal should be provided and the ground wire cannot be connected to any of the following places: a. Water pipe; b. Coal gas pipe; c. Sewage pipe; d. Lightning rod e. Telephone line f. Other unreliable places considered by a professional.</p>

### 6.4 Precautions on the Electrical Wiring Work

<p><b>⚠ WARNING</b></p>
<p>1) The electrical installation should be carried out by the professional as instructed by the local laws, regulations and also this manual.</p>
<p>2) The ground connection should be reliable and the ground wire should be connected to the dedicated device of the building by the professional.</p>
<p>3) Before starting work, the power must not be supplied to the unit.</p>
<p>4) The air switch coupled with the leakage current protection switch must be equipped in the circuits, which is of enough capacity and of both magnetic and thermal tripping functions in case of the short circuit and overload.</p>
<p>5) The electrical work should use a cable length enough to cover the entire distance with no connection. If it is unavoidable, please make sure the connection should be reliable, the external forces will not act on the wires and the joint is not bared. Otherwise it will cause electrical shock or fire etc.</p>
<p>6) The power cable with the rated voltage and exclusive circuit for the air conditioner should be used.</p>
<p>7) Do not pull the power cable by force after it is installed.</p>
<p>8) The diameter of the power cable should be large enough and once it is damaged, it must be replaced by the dedicated one.</p>
<p>9) The multi-wire copper cable should be used for the power cable and the transmission line.</p>

### 6.5 Precaution of Laying Wires

- 1) Use a wire stripper to strip off a length of the insulation layer at the end of the wires;
- 2) Loosen the screws on the terminal block of the air conditioner;
- 3) Press the ends of the cable tightly onto the round terminals corresponding to the size of the screws.
- 4) Pass the screw through the round terminals and fix it onto the terminal block.

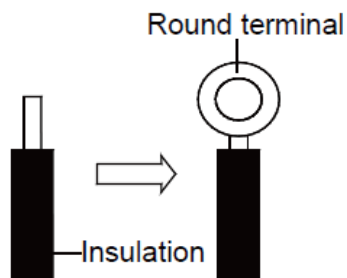
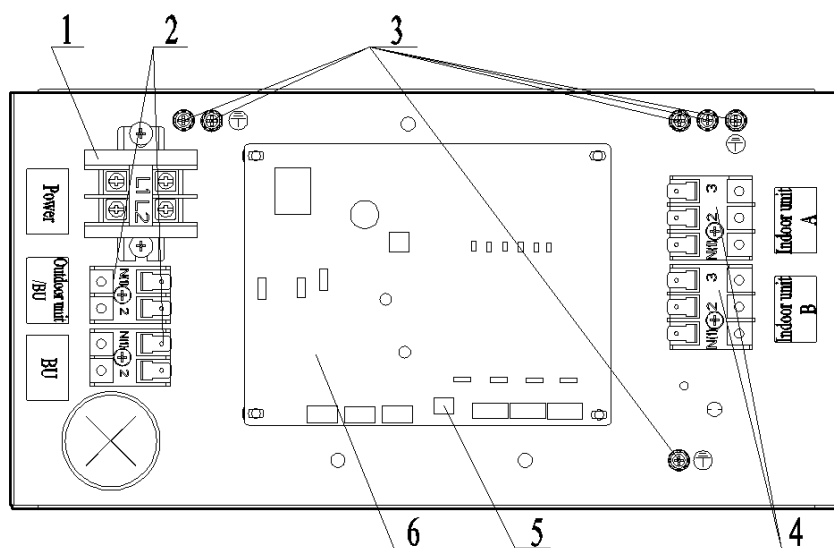

Fig. 25

### 6.6 Procedures for Electrical Wiring Work

- 1) Unscrew the electrical equipment plate.
- 2) The structure of behind the electrical equipment plate.



a) IS-BU12

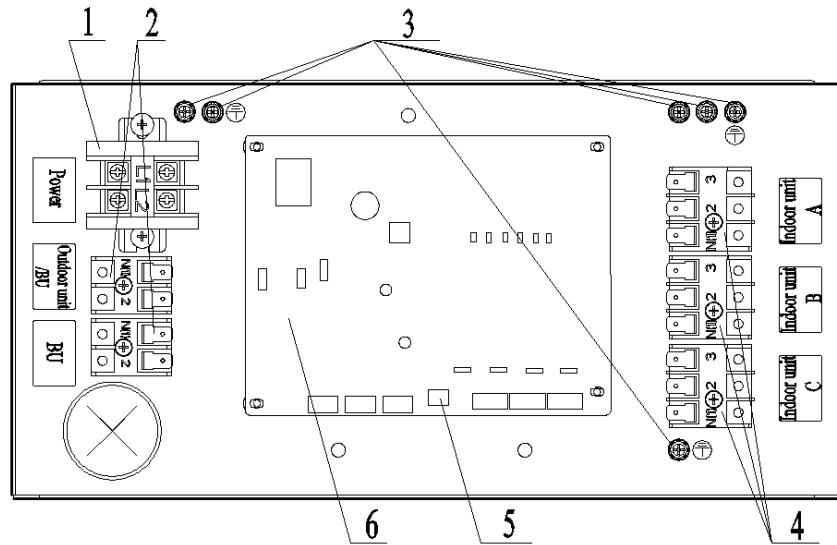

b) IS-BU13

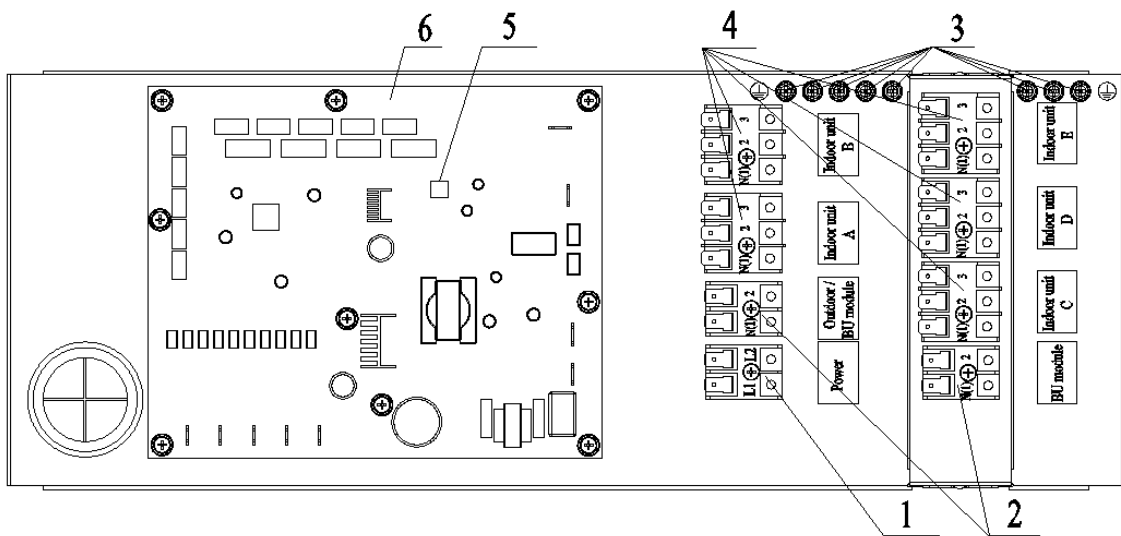

c) IS-BU15

NO.	1	2	3
Name	Terminal block for BU module power supply	Terminal block for transmission line	Ground screw
NO.	4	5	6
Name	Terminal block for indoor unit power supply	DIP switch	Printed circuit board

Fig. 26

- 3) Let the power cable and transmission line go through the rubber ring. In order to protect the power cable and transmission line from damaging by the hole, the rubber ring cannot fall from that, otherwise, it may cause electrical shock or fire etc.
- 4) Connect the power cable of the BU module to the L1, L2 terminals with the sign of Power and as well as the ground screw.
- 5) Connect the transmission line of the BU module to the N(1), 2 terminals with the sign of Outdoor unit/BU module.
- 6) If the transmission line need to be connected to the other BU module, please connect the extra

- line to the N(1), 2 terminals with the sign of BU module.
- 7) Connect the power cable of the indoor unit to the N(1), 2 and 3 terminals with the sign of Indoor unit A (B, C, D and E) and as well as the ground screw.
  - 8) Fix the power cable and transmission line firmly by cable fixing clip.
  - 9) Screw the electrical equipment plate.

<b>⚠ CAUTION</b>	
1)	The transmission line and the power cable must be separated with an interval of at least 2cm (3/4inch); otherwise it may be result in communication problem.
2)	Confirm the each cable connected to the terminal screw is exactly and securely after finishing the electric work.
3)	Fix each ground wire separately with the ground screw.
4)	When connecting indoor units, make sure to connect refrigerant pipes and power cables to the same connection ports marked with matching signs (A, B, C ,D and E).
5)	If the connecting wire is connected to the terminal incorrectly, the unit will not work normally.
6)	The refrigerant pipe should be supported by brackets, that is, don't let the unit withstand the weight of it.
7)	For the Flex+ system, each pipe should be labeled to tell which system it belongs to avoid mistaken inaccurate piping.

### 6.7 Instructions for DIP Switch

- ◆ 2 digits DIP is adopted to assign the address when using multi-BU modules and the address cannot be repeated in the same unit.
- ◆ One outdoor unit can connect to no more than 3 BU modules.
- ◆ “ON” side means "ON" and the opposite side represents "OFF".

**NOTICE!:** The black part is lever.

Table 12

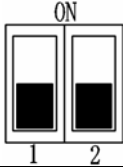
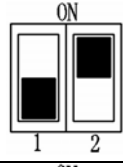
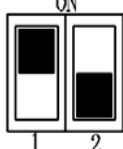
Number	DIP Code		Icon	Address
	DIP 1	DIP 2		
1	OFF	OFF		BU 1
2	OFF	ON		BU 2
3	ON	OFF		BU 3

## 7 Design of Drainage Pipeline

### 7.1 Installation of Drain Hose

- 1) Remove the rubber stopper of drain hole.
- 2) Connect the drain hose to the drain hole of BU module.
- 3) The drain hose should be kept at 5-10 degrees of gradient to facilitate discharge of the condensing water. Take care that does not exert too much force on the hose.
- 4) Thermal insulation materials should be placed at the joints of the drain hose so as to prevent from dew condensation. Fix the drain hose firmly by binding band.

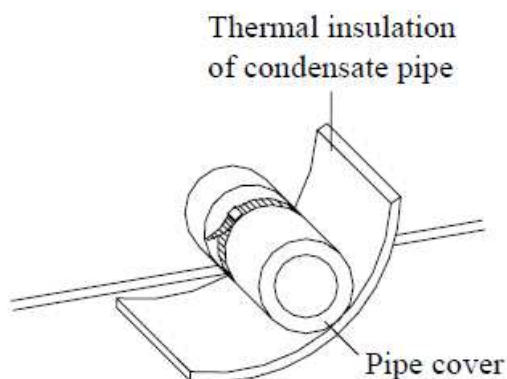

Fig. 27

- 5) The end of the drain hose should be inserted into the hole of drainage pipeline.

### 7.2 Design of Drainage Pipeline

- 1) The drainage pipeline should be kept at a certain gradient (1/50-1/100) so as to avoid bulges of pipes where there might be water bends.
- 2) The drainage pipeline is form of the hard PVC pipes for common purposes which can be purchased locally. The diameter of the PVC pipes is not less than 31mm (1-1/4inch) and the pipeline should be fixed as close to the BU module as possible.
- 3) Insert the drain hose into the drain hole of drainage pipeline. Use binding band to fix it tightly. It is not allowed to use adhesive glue to join the drain hose to the drainage hole.
- 4) When the drainage pipeline is laid for a couple of units, the position of the shared pipeline should be approximately 100mm lower than the drainage hole of each module. In this case, some special-purpose pipes with thicker walls will be used.

**NOTICE!** At intervals of about 1 meter (3-1/4feet), fix the drain pipes to the wall with brackets, not floating in the air.

## 8 Test Operation

After all the installation has been accomplished, follow the “operation test” as described in the outdoor unit owner’s manual.

## 9 Troubleshooting

### WARNING

- 1) In the event of abnormal conditions (such as an unpleasant smell), please shut off the power supply immediately and then contact the appointed service center; otherwise, the abnormal running would damage the air conditioner and also would cause electric shock or fire hazard .
- 2) Do not repair the air conditioning personally but instead contact the professionally skilled personnel at the appointed service center, as the incorrect repair would cause electric shock or fire hazard etc.

Table 13

Errors	Indicating LED flashing times			Indoor unit error code	Outdoor unit error code
	Yellow LED	Green LED	Red LED		
BU 1 is connected	Flash 1 time				
BU 2 is connected	Flash 2 times				
BU 3 is connected	Flash 3 times				
Indoor unit A is connected		Flash 1 time			
Indoor unit B is connected		Flash 2 times			
Indoor unit C is connected		Flash 3 times			
Indoor unit D is connected		Flash 4 times			
Indoor unit E is connected		Flash 5 times			
Indoor unit A gas tube temperature sensor error			Flash 1 time	b7	b7 indoor unit address
Indoor unit A liquid tube temperature sensor error			Flash 2 times	b5	b5 indoor unit address
Indoor unit B gas tube temperature sensor error			Flash 3 times	b7	b7 indoor unit address
Indoor unit B liquid tube temperature sensor error			Flash 4 times	b5	b5 indoor unit address
Indoor unit C gas tube temperature sensor error			Flash 5 times	b7	b7 indoor unit address
Indoor unit C liquid tube temperature sensor error			Flash 6 times	b5	b5 indoor unit address
Indoor unit D gas tube temperature sensor error			Flash 7 time	b7	b7 indoor unit address
Indoor unit D liquid tube temperature sensor error			Flash 8 times	b5	b5 indoor unit address
Indoor unit E gas tube temperature sensor error			Flash 9 time	b7	b7 indoor unit address
Indoor unit E liquid tube temperature sensor error			Flash 10 times	b5	b5 indoor unit address

## 10 After-Sales Service

If there is any quality or other issue, please contact the after-sales service center.

# CUSTOMER SUPPORT

Before contacting customer support, please see the troubleshooting guide above.

Visit our website to contact us, find answers to Frequently Asked Questions, and for other resources which may include an updated version of this user's guide.

 **WWW.IMPECCA.COM**

If you wish to contact us by phone, please be sure to have your model number and serial number ready and call us between 9:00am and 6:00pm ET, at +1 866-954-4440.

Keep tabs on Impecca's newest innovations & enter contests via our social network feeds:

 [www.facebook.com/Impecca/](http://www.facebook.com/Impecca/)

 [www.instagram.com/impecca/](http://www.instagram.com/impecca/)

 [@impeccausa](https://twitter.com/impeccausa)

© 2016 Impecca, a division of LT Inc., Wilkes Barre, PA.



Split Air Conditioner



Models:

ISMI-W092

ISMI-W122

Thank you for choosing our product.

For proper operation, please read and keep this manual carefully.

If you have lost the Owner's Manual, please contact the local agent or visit [www.impecca.com](http://www.impecca.com) for an electronic version.

# Content

## Operation Notices

Precautions.....	1
Parts name .....	6

## Screen Operation Guide

Buttons on remote controller .....	7
Introduction for icons on display screen .....	7
Introduction for buttons on remote controller.....	8
Function introduction for combination buttons.....	12
Operation guide .....	13
Replacement of batteries in remote controller.....	13
Emergency operation .....	14

## Maintenance

Clean and maintenance.....	14
----------------------------	----

## Malfunction

Malfunction analysis .....	17
----------------------------	----

## Installation Notice

Installation dimension diagram .....	21
Tools for installation.....	22
Selection of installation location .....	22
Requirements for electric connection .....	23

## Installation

Installation of indoor unit.....	24
Check after installation .....	29

## Test and operation

Test operation.....	29
---------------------	----

## Attachment

Configuration of connection pipe .....	30
Pipe expanding method.....	32
Wired Controller.....	33

This appliance is not intended for use by persons (including children) with reduced physical, sensory or mental capabilities, or lack of experience and knowledge, unless they have been given supervision or instruction concerning use of the appliance by a person responsible for their safety.

Children should be supervised to ensure that they do not play with the appliance.

R410A(R32/125: 50/50): 1975

## Explanation of Symbols

---



Indicates a hazardous situation that, if not avoided, will result in death or serious injury.



Indicates a hazardous situation that, if not avoided, could result in death or serious injury.

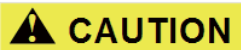

Indicates a hazardous situation that, if not avoided, may result in minor or moderate injury.



Indicates important but not hazard-related information, used to indicate risk of property damage.



Indicates a hazard that would be assigned a signal word WARNING or CAUTION.

## Precautions



### WARNING

#### **Operation and Maintenance**

- This appliance can be used by children aged from 8 years and above and persons with reduced physical, sensory or mental capabilities or lack of experience and knowledge if they have been given supervision or instruction concerning use of the appliance in a safe way and understand the hazards involved.
- Children shall not play with the appliance.
- Cleaning and user maintenance shall not be made by children without supervision.
- Do not connect air conditioner to multi-purpose socket. Otherwise, it may cause fire hazard.
- Do disconnect power supply when cleaning air conditioner. Otherwise, it may cause electric shock.
- If the supply cord is damaged, it must be replaced by the manufacturer, its service agent or similarly qualified persons in order to avoid a hazard.
- Do not wash the air conditioner with water to avoid electric shock.
- Do not spray water on indoor unit. It may cause electric shock or malfunction.
- After removing the filter, do not touch fins to avoid injury.
- Do not use fire or hair dryer to dry the filter to avoid deformation or fire hazard.

## Precautions



### WARNING

- Maintenance must be performed by qualified professionals. Otherwise, it may cause personal injury or damage.
- Do not repair air conditioner by yourself. It may cause electric shock or damage. Please contact dealer when you need to repair air conditioner.
- Do not extend fingers or objects into air inlet or air outlet. It may cause personal injury or damage.
- Do not block air outlet or air inlet. It may cause malfunction.
- Do not spill water on the remote controller, otherwise the remote controller may be broken.
- When below phenomenon occurs, please turn off air conditioner and disconnect power immediately, and then contact the dealer or qualified professionals for service.
  - Power cord is overheating or damaged.
  - There's abnormal sound during operation.
  - Circuit break trips off frequently.
  - Air conditioner gives off burning smell.
  - Indoor unit is leaking.
- If the air conditioner operates under abnormal conditions, it may cause malfunction, electric shock or fire hazard.
- When turning on or turning off the unit by emergency operation switch, please press this switch with an insulating object other than metal.
- Do not step on top panel of outdoor unit, or put heavy objects. It may cause damage or personal injury.

## Precautions



### WARNING

#### Attachment

- Installation must be performed by qualified professionals. Otherwise, it may cause personal injury or damage.
- Must follow the electric safety regulations when installing the unit.
- According to the local safety regulations, use qualified power supply circuit and circuit break.
- Do install the circuit break. If not, it may cause malfunction.
- An all-pole disconnection switch having a contact separation of at least 3mm in all poles should be connected in fixed wiring.
- Including an circuit break with suitable capacity, please note the following table. Air switch should be included magnet buckle and heating buckle function, it can protect the circuit-short and overload.
- Air Conditioner should be properly grounded. Incorrect grounding may cause electric shock.
- Don't use unqualified power cord.
- Make sure the power supply matches with the requirement of air conditioner. Unstable power supply or incorrect wiring or malfunction. Please install proper power supply cables before using the air conditioner.
- Properly connect the live wire, neutral wire and grounding wire of power socket.
- Be sure to cut off the power supply before proceeding any work related to electricity and safety.

## Precautions



### WARNING

- Do not put through the power before finishing installation.
- If the supply cord is damaged, it must be replaced by the manufacturer, its service agent or similarly qualified persons in order to avoid a hazard.
- The temperature of refrigerant circuit will be high, please keep the interconnection cable away from the copper tube.
- The appliance shall be installed in accordance with national wiring regulations.
- Installation must be performed in accordance with the requirement of NEC and CEC by authorized personnel only.
- The air conditioner is the first class electric appliance. It must be properly grounding with specialized grounding device by a professional. Please make sure it is always grounded effectively, otherwise it may cause electric shock.
- The yellow-green wire in air conditioner is grounding wire, which can't be used for other purposes.
- The grounding resistance should comply with national electric safety regulations.
- The appliance must be positioned so that the plug is accessible.
- All wires of indoor unit and outdoor unit should be connected by a professional.
- If the length of power connection wire is insufficient, please contact the supplier for a new one. Avoid extending the wire by yourself.

## Precautions



### WARNING

- For the air conditioner with plug, the plug should be reachable after finishing installation.
- For the air conditioner without plug, an circuit break must be installed in the line.
- If you need to relocate the air conditioner to another place, only the qualified person can perform the work. Otherwise, it may cause personal injury or damage.
- Select a location which is out of reach for children and far away from animals or plants. If it is unavoidable, please add the fence for safety purpose.
- The indoor unit should be installed close to the wall.

### Working temperature range

	Indoor side DB/WB(°C )	Outdoor side DB/WB(°C )
Maximum cooling	26.7/19.4	46.1/23.9
Maximum heating	26.7/-	23.9/18.3

### NOTICE:

- The temperature range for operating the unit with electric heating: -20°C~46.1°C;  
the temperature range for operating the unit without electric heating: -18°C~46.1°C

## Parts Name

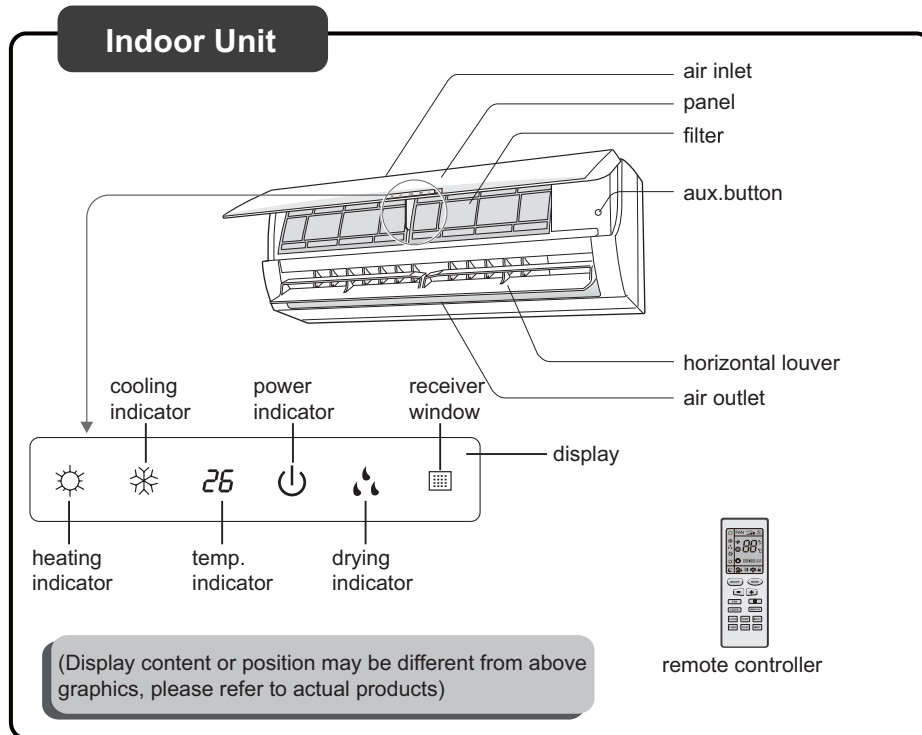

### **NOTICE:**

Actual product may be different from above graphics, please refer to actual products.

## Buttons on remote controller

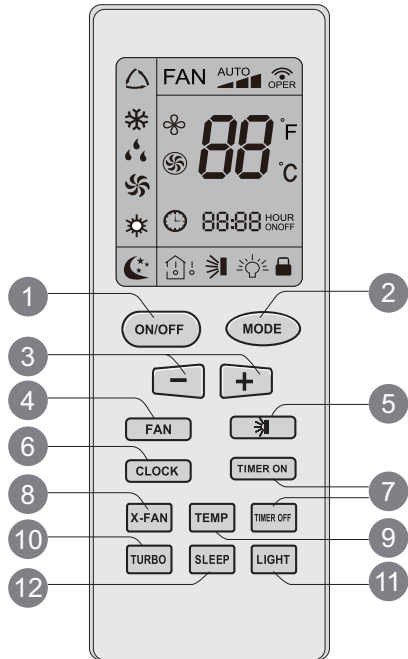

- 1 ON/OFF button
- 2 MODE button
- 3 +/- button
- 4 FAN button
- 5 button
- 6 CLOCK button
- 7 TIMER ON/TIMER OFF button
- 8 X-FAN button  
Note: X-FAN is the same with BLOW
- 9 TEMP button
- 10 TURBO button
- 11 LIGHT button
- 12 SLEEP button

## Introduction for icons on display screen

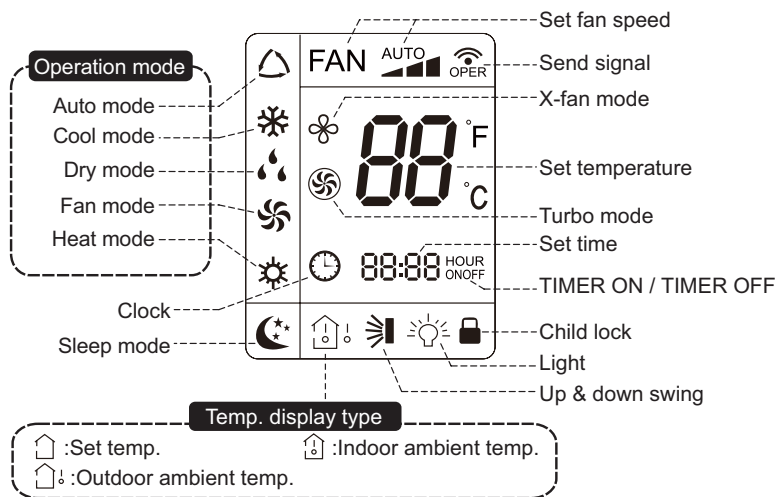

## Introduction for buttons on remote controller

### Note:

- After putting through the power, the air conditioner will give out a sound. Operation indicator "⏻" is ON (red indicator). After that, you can operate the air conditioner by using remote controller.

### 1 ON/OFF button

Press this button can turn on or turn off the air conditioner. After turning on the air conditioner, operation indicator "⏻" on indoor unit's display is ON (green indicator. The colour is different for different models), and indoor unit will give out a sound.

### 2 MODE button

Press this button to select your required operation mode.



- When selecting auto mode, air conditioner will start auto operation according to indoor ambient temperature. Set temperature can't be adjusted and will not be displayed as well. Press "FAN" button can adjust fan speed. Press "↻" button can adjust fan blowing angle.
- After selecting cool mode, air conditioner will operate under cool mode. Cool indicator "❄" on indoor unit is ON. Press "+" or "-" button to adjust set temperature. Press "FAN" button to adjust fan speed. Press "↻" button to adjust fan blowing angle.
- When selecting dry mode, the air conditioner operates at low speed under dry mode. Dry indicator "💧" on indoor unit is ON. Under dry mode, fan speed can't be adjusted. Press "↻" button to adjust fan blowing angle.
- When selecting fan mode, the air conditioner will only blow fan, no cooling and no heating. All indicators are OFF. Press "FAN" button to adjust fan speed. Press "↻" button to adjust fan blowing angle.
- When selecting heating mode, the air conditioner operates under heat mode. Heat indicator "☀" on indoor unit is ON. Press "+" or "-" button to adjust set temperature. Press "FAN" button to adjust fan speed. Press "↻" button to adjust fan blowing angle. (Cooling only unit won't receive heating mode signal. If setting heat mode with remote controller, press ON/OFF button can't start up the unit).

### Note:

- For preventing cold air, after starting up heating mode, indoor unit will delay 1~5 minutes to blow air (actual delay time is depend on indoor ambient temperature).
- Set temperature range from remote controller: 16~30°C ; Fan speed: auto, low speed, medium speed, high speed.

## Introduction for buttons on remote controller

### 3 +/- button

- Press "+" or "-" button once increase or decrease set temperature 1°C . Holding "+" or "-" button, 2s later, set temperature on remote controller will change quickly. On releasing button after setting is finished, temperature indicator on indoor unit will change accordingly. (Temperature can't be adjusted under auto mode)
- When setting TIMER ON, TIMER OFF or CLOCK, press "+" or "-" button to adjust time. (Refer to CLOCK, TIMER ON, TIMER OFF buttons) When setting TIMER ON, TIMER OFF or CLOCK, press "+" or "-" button to adjust time. (Refer to CLOCK, TIMER ON, TIMER OFF buttons)

### 4 FAN button

Pressing this button can set fan speed circularly as: auto (AUTO), low(▲), medium (▲▲), high(▲▲▲).



#### Note:

- Under AUTO speed, the IDU fan motor will adjust the fan speed (high, medium or low speed) according to ambient temperature.
- Fan speed under dry mode is low speed.

### 5 Fan swing button

Press this button can select up&down swing angle. Fan blow angle can be selected circularly as below:

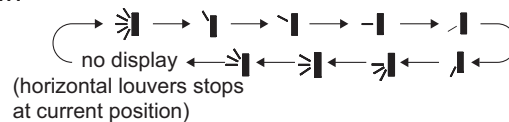

- When selecting "Fan swing icon", air conditioner is blowing fan automatically. Horizontal louver will automatically swing up & down at maximum angle.
- When selecting "no display", "Fan swing icon", "Fan swing icon", "Fan swing icon", "Fan swing icon", air conditioner is blowing fan at fixed position. Horizontal louver will stop at the fixed position.
- When selecting "Fan swing icon", "Fan swing icon", "Fan swing icon", air conditioner is blowing fan at fixed angle. Horizontal louver will send air at the fixed angle.
- Hold "Fan swing icon" button above 2s to set your required swing angle. When reaching your required angle, release the button.

#### Note:

- "Fan swing icon", "Fan swing icon", "Fan swing icon" may not be available. When air conditioner receives this signal, the air conditioner will blow fan automatically.

## Introduction for buttons on remote controller

### 6 CLOCK button

Press this button to set clock time. "🕒" icon on remote controller will blink. Press "+" or "-" button within 5s to set clock time. Each pressing of "+" or "-" button, clock time will increase or decrease 1 minute. If hold "+" or "-" button, 2s later, time will change quickly. Release this button when reaching your required time. Press "CLOCK" button to confirm the time. "🕒" icon stops blinking.

#### Note:

- Clock time adopts 24-hour mode.
- The interval between two operation can't exceeds 5s. Otherwise, remote controller will quit setting status. Operation for TIMER ON/TIMER OFF is the same.

### 7 TIMER ON / TIMER OFF button

#### • TIMER ON button

"TIMER ON" button can set the time for timer on. After pressing this button, "🕒" icon disappears and the word "ON" on remote controller blinks. Press "+" or "-" button to adjust TIMER ON setting. After each pressing "+" or "-" button, TIMER ON setting will increase or decrease 1min. Hold "+" or "-" button, 2s later, the time will change quickly until reaching your required time. Press "TIMER ON" to confirm it. The word "ON" will stop blinking. "🕒" icon resumes displaying. Cancel TIMER ON: Under the condition that TIMER ON is started up, press "TIMER ON" button to cancel it.

#### • TIMER OFF button

"TIMER OFF" button can set the time for timer off. After pressing this button, "🕒" icon disappears and the word "OFF" on remote controller blinks. Press "+" or "-" button to adjust TIMER OFF setting. After each pressing "+" or "-" button, TIMER OFF setting will increase or decrease 1min. Hold "+" or "-" button, 2s later, the time will change quickly until reaching your required time. Press "TIMER OFF" word "OFF" will stop blinking. "🕒" icon resumes displaying. Cancel TIMER OFF. Under the condition that TIMER OFF is started up, press "TIMER OFF" button to cancel it.

#### Note:

- Under on and off status, you can set TIMER OFF or TIMER ON simultaneously.
- Before setting TIMER ON or TIMER OFF, please adjust the clock time.
- After starting up TIMER ON or TIMER OFF, set the constant circulating valid. After that, air conditioner will be turned on or turned off according to setting time. ON/OFF button has no effect on setting. If you don't need this function, please use remote controller to cancel it.

## Introduction for buttons on remote controller

### 8 X-FAN button

Press this button under cool and dry mode to start up x-fan function, and "☼" icon on remote controller will be displayed. Press this button again to cancel x-fan function, and "☼" icon will disappear.

#### Note:

- When x-fan function is on, if the air conditioner is turned off, indoor fan will still operate at low speed for a while to blow the residual water inside the air duct.
- During x-fan operation, press X-FAN button to turn off x-fan function. Indoor fan will stop operation immediately.

### 9 TEMP button

By pressing this button, you can see indoor set temperature, indoor ambient temperature or outdoor ambient temperature on indoor unit's display. The setting on remote controller is selected circularly as below:

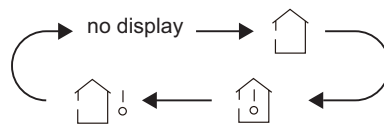

- When selecting "🏠" or no display with remote controller, temperature indicator on indoor unit displays set temperature.
- When selecting "🏠☀️" with remote controller, temperature indicator on indoor unit displays indoor ambient temperature.
- When selecting "🏠☀️☁️" with remote controller, temperature indicator on indoor unit displays outdoor ambient temperature.

#### Note:

- Outdoor temperature display is not available for some models. At that time, indoor unit receives "🏠☀️" signal, while it displays indoor set temperature.
- It's defaulted to display set temperature when turning on the unit. There is no display in the remote controller.
- Only for the models whose indoor unit has dual-8 display.
- When selecting displaying of indoor or outdoor ambient temperature, indoor temperature indicator displays corresponding temperature and automatically turn to display set temperature after three or five seconds.

### 10 TURBO button

Under COOL or HEAT mode, press this button to turn to quick COOL or quick HEAT mode. "⚡" icon is displayed on remote controller. Press this button again to exit turbo function and "⚡" icon will disappear.

## Introduction for buttons on remote controller

### 11 SLEEP button

Under COOL, HEAT or DRY mode, press this button to start up sleep function. "☾" icon is displayed on remote controller. Press this button again to cancel sleep function and "☾" icon will disappear.

### 12 LIGHT button

Press this button to turn off display light on indoor unit. "☀" icon on remote controller disappears. Press this button again to turn on display light. "☀" icon is displayed.

## Function introduction for combination buttons

### Child lock function

Press "+" and "-" simultaneously to turn on or turn off child lock function. When child lock function is on, "🔒" icon is displayed on remote controller. If you operate the remote controller, the "🔒" icon will blink three times without sending signal to the unit.

### Temperature display switchover function

Under OFF status, press "-" and "MODE" buttons simultaneously to switch temperature display between °C and °F .

## Operation guide

1. After putting through the power, press "ON/OFF" button on remote controller to turn on the air conditioner.
2. Press "MODE" button to select your required mode: AUTO, COOL, DRY, FAN, HEAT.
3. Press "+" or "-" button to set your required temperature. (Temperature can't be adjusted under auto mode).
4. Press "FAN" button to set your required fan speed: auto, low, medium and high speed.
5. Press "↻" button to select fan blowing angle.

## Replacement of batteries in remote controller

1. Press the back side of remote controller marked with "OPEN", as shown in the fig, and then push out the cover of battery box along the arrow direction.
2. Replace two 7# (AAA 1.5V) dry batteries, and make sure the position of "+" polar and "-" polar are correct.
3. Reinstall the cover of battery box.

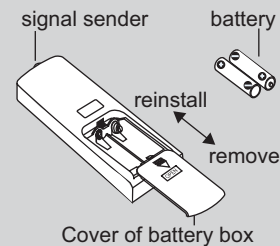

- During operation, point the remote control signal sender at the receiving window on indoor unit.
- The distance between signal sender and receiving window should be no more than 8m, and there should be no obstacles between them.
- Signal may be interfered easily in the room where there is fluorescent lamp or wireless telephone; remote controller should be close to indoor unit during operation.
- Replace new batteries of the same model when replacement is required.
- When you don't use remote controller for a long time, please take out the batteries.
- If the display on remote controller is fuzzy or there's no display, please replace batteries.

## Emergency operation

If remote controller is lost or damaged, please use auxiliary button to turn on or turn off the air conditioner. The operation in details are as below:  
As shown in the fig. Open panel, press aux. button to turn on or turn off the air conditioner. When the air conditioner is turned on, it will operate under auto mode.

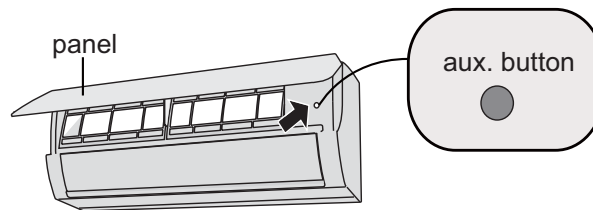

### **⚠ WARNING:**

Use insulated object to press the auto button

## Clean and maintenance

### **⚠ WARNING**

- Turn off the air conditioner and disconnect the power before cleaning the air conditioner to avoid electric shock.
- Do not wash the air conditioner with water to avoid electric shock.
- Do not use volatile liquid to clean the air conditioner.

### **Clean surface of indoor unit**

When the surface of indoor unit is dirty, it is recommended to use a soft dry cloth or wet cloth to wipe it.

### **NOTICE:**

- Do not remove the panel when cleaning it.

## Clean and maintenance

### Clean filter

- 1 Open panel**  
Pull out the panel to a certain angle as shown in the fig.

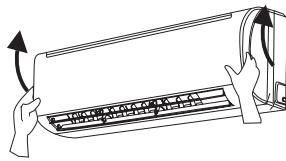

- 2 Remove filter**  
Remove the filter as indicated in the fig.

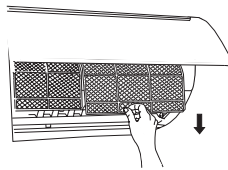

- 3 Clean filter**
- Use dust catcher or water to clean the filter.
  - When the filter is very dirty, use the water (below 45°C ) to clean it, and then put it in a shady and cool place to dry.

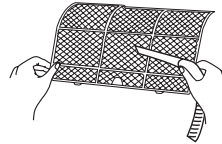

- 4 Install filter**  
Install the filter and then close the panel cover tightly.

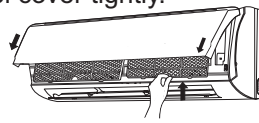

### WARNING

- The filter should be cleaned every three months. If there is much dust in the operation environment, clean frequency can be increased.
- After removing the filter, do not touch fins to avoid injury.
- Do not use fire or hair dryer to dry the filter to avoid deformation or fire hazard.

## Clean and maintenance

1. Check whether air inlets and air outlets are blocked.
2. Check whether air switch, plug and socket are in good condition.
3. Check whether filter is clean.
4. Check whether mounting bracket for outdoor unit is damaged or corroded.  
If yes, please contact dealer.
5. Check whether drainage pipe is damaged.

1. Disconnect power supply.
2. Clean filter and indoor unit's panel.
3. Check whether mounting bracket for outdoor unit is damaged or corroded.  
If yes, please contact dealer.

### Notice for recovery

1. Many packing materials are recyclable materials.  
Please dispose them in appropriate recycling unit.
2. If you want to dispose the air conditioner, please contact local dealer or consultant service center for the correct disposal method.

## Malfuction analysis

### General phenomenon analysis

Please check below items before asking for maintenance. If the malfunction still can't be eliminated, please contact local dealer or qualified professionals.

Phenomenon	Check items	Solution
Indoor unit can't receive remote controller's signal or remote controller has no action.	<ul style="list-style-type: none"> <li>• Whether it's interfered severely (such as static electricity, stable voltage)?</li> </ul>	<ul style="list-style-type: none"> <li>• Pull out the plug. Reinsert the plug after about 3min, and then turn on the unit again.</li> </ul>
	<ul style="list-style-type: none"> <li>• Whether remote controller is within the signal receiving range?</li> </ul>	<ul style="list-style-type: none"> <li>• Signal receiving range is 8m.</li> </ul>
	<ul style="list-style-type: none"> <li>• Whether there are obstacles?</li> </ul>	<ul style="list-style-type: none"> <li>• Remove obstacles.</li> </ul>
	<ul style="list-style-type: none"> <li>• Whether remote controller is pointing at the receiving window?</li> </ul>	<ul style="list-style-type: none"> <li>• Select proper angle and point the remote controller at the receiving window on indoor unit.</li> </ul>
	<ul style="list-style-type: none"> <li>• Is sensitivity of remote controller low; fuzzy display and no display?</li> </ul>	<ul style="list-style-type: none"> <li>• Check the batteries. If the power of batteries is too low, please replace them.</li> </ul>
	<ul style="list-style-type: none"> <li>• No display when operating remote controller?</li> </ul>	<ul style="list-style-type: none"> <li>• Check whether remote controller appears to be damaged. If yes, replace it.</li> </ul>
	<ul style="list-style-type: none"> <li>• Fluorescent lamp in room?</li> </ul>	<ul style="list-style-type: none"> <li>• Take the remote controller close to indoor unit.</li> <li>• Turn off the fluorescent lamp and then try it again.</li> </ul>
No air emitted from indoor unit	<ul style="list-style-type: none"> <li>• Air inlet or air outlet of indoor unit is blocked?</li> </ul>	<ul style="list-style-type: none"> <li>• Eliminate obstacles.</li> </ul>
	<ul style="list-style-type: none"> <li>• Under heating mode, indoor temperature is reached to set temperature?</li> </ul>	<ul style="list-style-type: none"> <li>• After reaching to set temperature, indoor unit will stop blowing out air.</li> </ul>
	<ul style="list-style-type: none"> <li>• Heating mode is turned on just now?</li> </ul>	<ul style="list-style-type: none"> <li>• In order to prevent blowing out cold air, indoor unit will be started after delaying for several minutes, which is a normal phenomenon.</li> </ul>

## Malfunction analysis

Phenomenon	Check items	Solution
Air conditioner can't operate	• Power failure?	• Wait until power recovery.
	• Is plug loose?	• Reinsert the plug.
	• Circuit break trips off or fuse is burnt out?	• Ask professional to replace circuit break or fuse.
	• Wiring has malfunction?	• Ask professional to replace it.
	• Unit has restarted immediately after stopping operation?	• Wait for 3min, and then turn on the unit again.
	• Whether the function setting for remote controller is correct?	• Reset the function.
Mist is emitted from indoor unit's air outlet	• Indoor temperature and humidity is high?	• Because indoor air is cooled rapidly. After a while, indoor temperature and humidity will be decrease and mist will disappear.
Set temperature can't be adjusted	• Unit is operating under auto mode?	• Temperature can't be adjusted under auto mode. Please switch the operation mode if you need to adjust temperature.
	• Your required temperature exceeds the set temperature range?	• Set temperature range: 16°C ~30°C .
Cooling (heating) effect is not good.	• Voltage is too low?	• Wait until the voltage resumes normal.
	• Filter is dirty?	• Clean the filter.
	• Set temperature is in proper range?	• Adjust temperature to proper range.
	• Door and window are open?	• Close door and window.

## Malfunction analysis

Phenomenon	Check items	Solution
Odours are emitted	<ul style="list-style-type: none"> <li>• Whether there's odour source, such as furniture and cigarette, etc.</li> </ul>	<ul style="list-style-type: none"> <li>• Eliminate the odour source.</li> <li>• Clean the filter.</li> </ul>
Air conditioner operates abnormally	<ul style="list-style-type: none"> <li>• Whether there's interference, such as thunder, wireless devices, etc.</li> </ul>	<ul style="list-style-type: none"> <li>• Disconnect power, put back power, and then turn on the unit again.</li> </ul>
Outdoor unit has vapor	<ul style="list-style-type: none"> <li>• Heating mode is turned on?</li> </ul>	<ul style="list-style-type: none"> <li>• During defrosting under heating mode, it may generate vapor, which is a normal phenomenon.</li> </ul>
"Water flowing" noise	<ul style="list-style-type: none"> <li>• Air conditioner is turned on or turned off just now?</li> </ul>	<ul style="list-style-type: none"> <li>• The noise is the sound of refrigerant flowing inside the unit, which is a normal phenomenon.</li> </ul>
Cracking noise	<ul style="list-style-type: none"> <li>• Air conditioner is turned on or turned off just now?</li> </ul>	<ul style="list-style-type: none"> <li>• This is the sound of friction caused by expansion and/or contraction of panel or other parts due to the change of temperature.</li> </ul>

## Malfunction analysis

### Error Code

- When air conditioner status is abnormal, temperature indicator on indoor unit will blink to display corresponding error code. Please refer to below list for identification of error code.



Above indicator diagram is only for reference. Please refer to actual product for the actual indicator and position.

Error code	Troubleshooting
Heating indicator ON 10s OFF 0.5s	Means defrosting status. It's the normal phenomenon.
E5	It can be eliminated after restarting the unit. If not, please contact qualified professionals for service.
H6	It can be eliminated after restarting the unit. If not, please contact qualified professionals for service.
C5	Please contact qualified professionals for service.
F1	Please contact qualified professionals for service.
F2	Please contact qualified professionals for service.
E6	It can be eliminated after restarting the unit. If not, please contact qualified professionals for service.

Note: If there're other error codes, please contact qualified professionals for service.

### WARNING

- When below phenomenon occurs, please turn off air conditioner and disconnect power immediately, and then contact the dealer or qualified professionals for service.
  - Power cord is overheating or damaged.
  - There's abnormal sound during operation.
  - Air switch trips off frequently.
  - Air conditioner gives off burning smell.
  - Indoor unit is leaking.
- Do not repair or refit the air conditioner by yourself.
- If the air conditioner operates under abnormal conditions, it may cause malfunction, electric shock or fire hazard.

## Installation dimension diagram

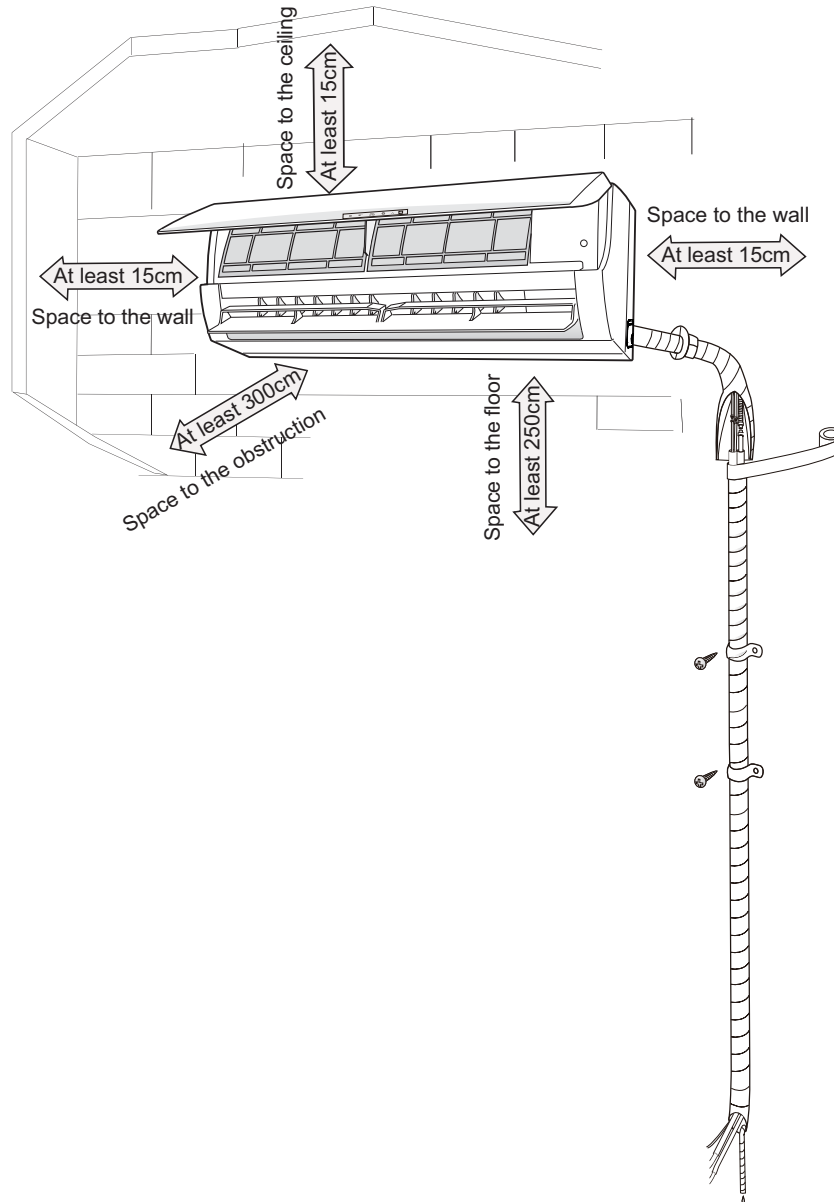

## Tools for installation

1 Level meter	2 Screw driver	3 Impact drill
4 Drill head	5 Pipe expander	6 Torque wrench
7 Open-end wrench	8 Pipe cutter	9 Leakage detector
10 Vacuum pump	11 Pressure meter	12 Universal meter
13 Inner hexagon spanner		14 Measuring tape

### Note:

- Please contact the local agent for installation.
- Don't use unqualified power cord.

## Selection of installation location

Basic requirement	Indoor unit
<p>Installing the unit in the following places may cause malfunction. If it is unavoidable, please consult the local dealer:</p> <ol style="list-style-type: none"> <li>1. The place with strong heat sources, vapors, flammable or explosive gas, or volatile objects spread in the air.</li> <li>2. The place with high-frequency devices (such as welding machine, medical equipment).</li> <li>3. The place near coast area.</li> <li>4. The place with oil or fumes in the air.</li> <li>5. The place with sulfureted gas.</li> <li>6. Other places with special circumstances.</li> <li>7. The appliance shall not be installed in the laundry</li> </ol>	<ol style="list-style-type: none"> <li>1. There should be no obstruction near air inlet and air outlet.</li> <li>2. Select a location where the condensation water can be dispersed easily and won't affect other people.</li> <li>3. Select a location which is convenient to connect the outdoor unit and near the power socket.</li> <li>4. Select a location which is out of reach for children.</li> <li>5. The location should be able to withstand the weight of indoor unit and won't increase noise and vibration.</li> <li>6. The appliance must be installed 2.5m above floor.</li> <li>7. Don't install the indoor unit right above the electric appliance.</li> <li>8. Please try your best to keep way from fluorescent lamp.</li> </ol>

## Requirements for electric connection

### Safety precaution

1. Must follow the electric safety regulations when installing the unit.
2. According to the local safety regulations, use qualified power supply circuit and circuit break.
3. Make sure the power supply matches with the requirement of air conditioner. Unstable power supply or incorrect wiring or malfunction. Please install proper power supply cables before using the air conditioner.
4. Properly connect the live wire, neutral wire and grounding wire of power socket.
5. Be sure to cut off the power supply before proceeding any work related to electricity and safety.
6. Do not put through the power before finishing installation.
7. If the supply cord is damaged, it must be replaced by the manufacturer, its service agent or similarly qualified persons in order to avoid a hazard.
8. The temperature of refrigerant circuit will be high, please keep the interconnection cable away from the copper tube.
9. The appliance shall be installed in accordance with national wiring regulations.
10. Installation must be performed in accordance with the requirement of NEC and CEC by authorized personnel only.

### Grounding requirement

1. The air conditioner is the first class electric appliance. It must be properly grounding with specialized grounding device by a professional. Please make sure it is always grounded effectively, otherwise it may cause electric shock.
2. The yellow-green wire in air conditioner is grounding wire, which can't be used for other purposes.
3. The grounding resistance should comply with national electric safety regulations.
4. The appliance must be positioned so that the plug is accessible.
5. An all-pole disconnection switch having a contact separation of at least 3mm in all poles should be connected in fixed wiring.
6. Including an circuit break with suitable capacity, please note the following table. Circuit break should be included magnet buckle and heating buckle function, it can protect the circuit-short and overload. (Caution: please do not use the fuse only for protect the circuit)

## Installation of indoor unit

### Step one: choosing installation location

Recommend the installation location to the client and then confirm it with the client.

### Step two: install wall-mounting frame

1. Hang the wall-mounting frame on the wall; adjust it in horizontal position with the level meter and then point out the screw fixing holes on the wall.
2. Drill the screw fixing holes on the wall with impact drill (the specification of drill head should be the same as the plastic expansion particle) and then fill the plastic expansion particles in the holes.
3. Fix the wall-mounting frame on the wall with tapping screws (ST4.2X25TA) and then check if the frame is firmly installed by pulling the frame. If the plastic expansion particle is loose, please drill another fixing hole nearby.

### Step three: open piping hole

1. Choose the position of piping hole according to the direction of outlet pipe. The position of piping hole should be a little lower than the wall-mounted frame, shown as below.

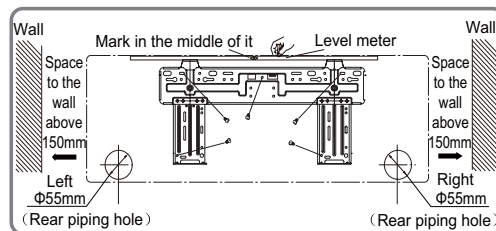

2. Open a piping hole with the diameter of  $\Phi 55$  on the selected outlet pipe position. In order to drain smoothly, slant the piping hole on the wall slightly downward to the outdoor side with the gradient of  $5-10^\circ$ .

## Installation of indoor unit

### Note:

- Pay attention to dust prevention and take relevant safety measures when opening the hole.
- The plastic expansion particles are not provided and should be bought locally.

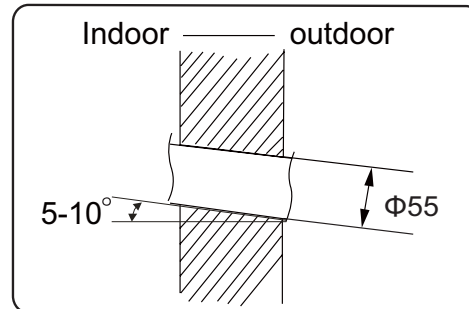

### Step four: outlet pipe

1. The pipe can be led out in the direction of right, rear right, left or rear left.

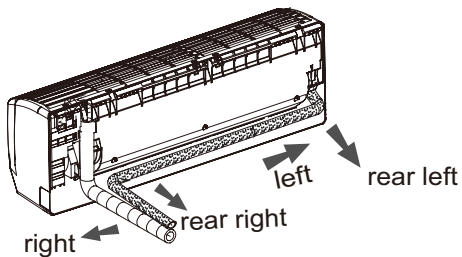

2. When select leading out the pipe from left or right, please cut off the corresponding hole on the bottom case.

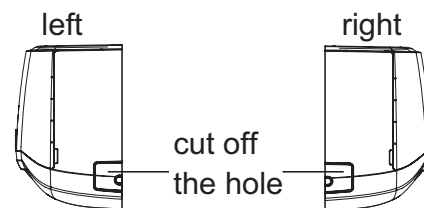

### Step five: connect the pipe of indoor unit

1. Aim the pipe joint at the corresponding bellmouth.
2. Pretightening the union nut with hand.

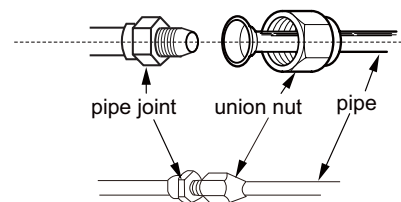

3. Adjust the torque force by referring to the following sheet. Place the open-end wrench on the pipe joint and place the torque wrench on the union nut. Tighten the union nut with torque wrench.

## Installation of indoor unit

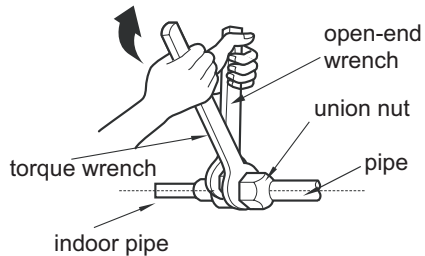

Hex nut diameter	Tightening torque (N·m)
Φ 6	15~20
Φ 9.52	30~40
Φ 12	45~55
Φ 16	60~65
Φ 19	70~75

4. Wrap the indoor pipe and joint of connection pipe with insulating pipe, and then wrap it with tape.

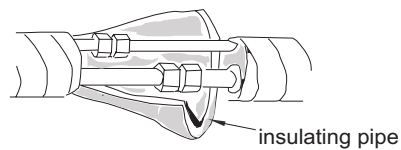

### Step six: install drain hose

1. Connect the drain hose to the outlet pipe of indoor unit.
2. Bind the joint with tape.

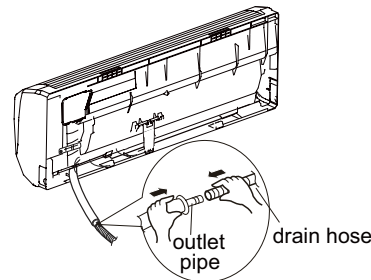
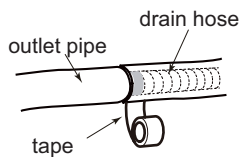

#### Note:

- Add insulating pipe in the indoor drain hose in order to prevent condensation.
- The plastic expansion particles are not provided.

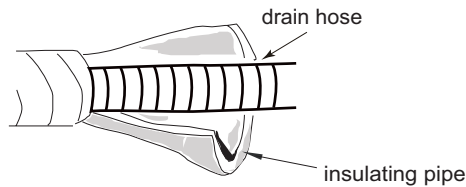

### Step seven: connect wire of indoor unit

1. Open the panel, remove the screw on the wiring cover and then take down the cover.

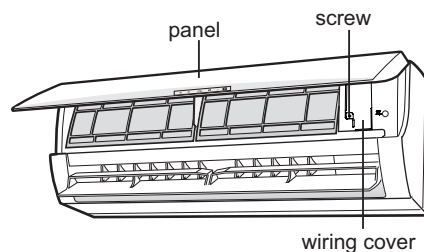

## Installation of indoor unit

2. Make the power connection cord go through the cable-cross hole at the back of indoor unit and then pull it out from the front side.

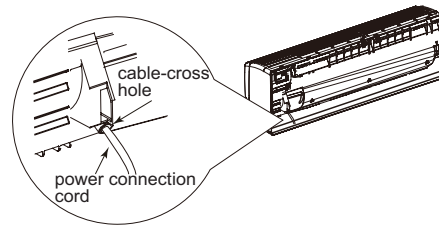

3. Remove the wire clip; connect the power connection cord to the wiring terminal according to the color ;tighten the screws and then fix the power connection cord with wire clip.  
If there is no wired controller in the product you bought ,you should put the wire fixed by the wire clip inside of the electric box first before connecting the power connection cord.

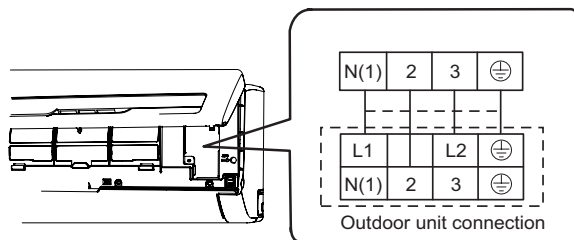

4. Put wiring cover back and then tighten the screw.
5. Close the panel.

### Note:

- All wires of indoor unit and outdoor unit should be connected by a professional.
- If the length of power connection cord is insufficient, please contact the supplier for a new one. Avoid extending the cord by yourself.
- For the air conditioner with plug, the plug should be reachable after finishing installation.
- For the air conditioner without plug, an circuit breaker must be installed in the line. The air switch should be all-pole parting and the contact parting distance should be more than 3mm.

## Installation of indoor unit

### Step eight: bind up pipe

1. Bind up the connection pipe, power cord and drain hose with the band.

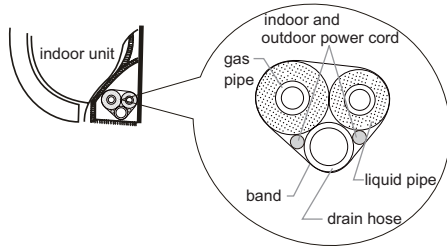

2. Reserve a certain length of drain hose and power cord for installation when binding them. When binding to a certain degree, separate the indoor power and then separate the drain hose.

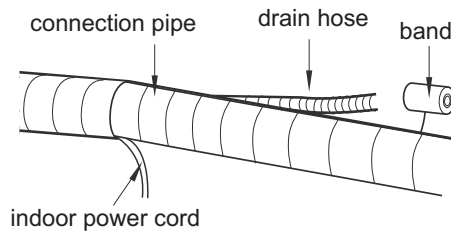

3. Bind them evenly.
4. The liquid pipe and gas pipe should be bound separately at the end.

**Note:**

- The power cord and control wire can't be crossed or winding.
- The drain hose should be bound at the bottom.

### Step nine: hang the indoor unit

1. Put the bound pipes in the wall pipe and then make them pass through the wall hole.
2. Hang the indoor unit on the wall-mounting frame.
3. Stuff the gap between pipes and wall hole with sealing gum.
4. Fix the wall pipe.
5. Check if the indoor unit is installed firmly and closed to the wall.

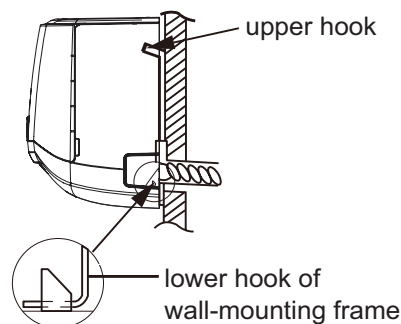
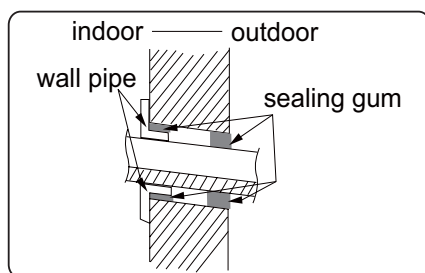

**Note:**

- Do not bend the drain hose too excessively in order to prevent blocking.

## Check after installation

- Check according to the following requirement after finishing installation.

Items to be checked	Possible malfunction
Has the unit been installed firmly?	The unit may drop, shake or emit noise.
Have you done the refrigerant leakage test?	It may cause insufficient cooling (heating) capacity.
Is heat insulation of pipeline sufficient?	It may cause condensation and water dripping.
Is water drained well?	It may cause condensation and water dripping.
Is the voltage of power supply according to the voltage marked on the nameplate?	It may cause malfunction or damaging the parts.
Is electric wiring and pipeline installed correctly?	It may cause malfunction or damaging the parts.
Is the unit grounded securely?	It may cause electric leakage.
Does the power cord follow the specification?	It may cause malfunction or damaging the parts.
Is there any obstruction in the air inlet and outlet?	It may cause insufficient cooling (heating) capacity.
The dust and sundries caused during installation are removed?	It may cause malfunction or damaging the parts.
The gas valve and liquid valve of connection pipe are open completely?	It may cause insufficient cooling (heating) capacity.

## Test operation

### 1. Preparation of test operation

- The client approves the air conditioner.
- Specify the important notes for air conditioner to the client.

### 2. Method of test operation

- Put through the power, press ON/OFF button on the remote controller to start operation.
- Press MODE button to select AUTO, COOL, DRY, FAN and HEAT to check whether the operation is normal or not.
- If the ambient temperature is lower than 16°C , the air conditioner can't start cooling.

## Configuration of connection pipe

1. Standard length of connection pipe
  - 5m, 7.5m, 8m.
2. Min. length of connection pipe is 3m.
3. Max. length of connection pipe and max. high difference.

Cooling capacity	Max length of connection pipe	Max height difference	Cooling capacity	Max length of connection pipe	Max height difference
5000Btu/h (1465W)	15	5	24000Btu/h (7032W)	25	10
7000Btu/h (2051W)	15	5	28000Btu/h (8204W)	30	10
9000Btu/h (2637W)	15	5	36000Btu/h (10548W)	30	20
12000Btu/h (3516W)	20	10	42000Btu/h (12306W)	30	20
18000Btu/h (5274W)	25	10	48000Btu/h (14064W)	30	20

4. The additional refrigerant oil and refrigerant charging required after prolonging connection pipe
  - After the length of connection pipe is prolonged for 10m at the basis of standard length, you should add 5ml of refrigerant oil for each additional 5m of connection pipe.
  - The calculation method of additional refrigerant charging amount (on the basis of liquid pipe):
 
$$\text{Additional refrigerant charging amount} = \text{prolonged length of liquid pipe} \times \text{additional refrigerant charging amount per meter}$$
  - Basing on the length of standard pipe, add refrigerant according to the requirement as shown in the table. The additional refrigerant charging amount per meter is different according to the diameter of liquid pipe. See the following sheet.

## Configuration of connection pipe

Additional refrigerant charging amount for R22, R407C, R410A and R134a

Diameter of connection pipe		Outdoor unit throttle	
Liquid pipe(mm)	Gas pipe(mm)	Cooling only(g/m)	Cooling and heating(g/m)
Φ6	Φ9.52 or Φ12	15	20
Φ6 or Φ9.52	Φ16 or Φ19	15	50
Φ12	Φ19 or Φ22.2	30	120
Φ16	Φ25.4 or Φ31.8	60	120
Φ19	—	250	250
Φ22.2	—	350	350

## Pipe expanding method

### Note:

Improper pipe expanding is the main cause of refrigerant leakage. Please expand the pipe according to the following steps:

#### A: Cut the pipe

- Confirm the pipe length according to the distance of indoor unit and outdoor unit.
- Cut the required pipe with pipe cutter.

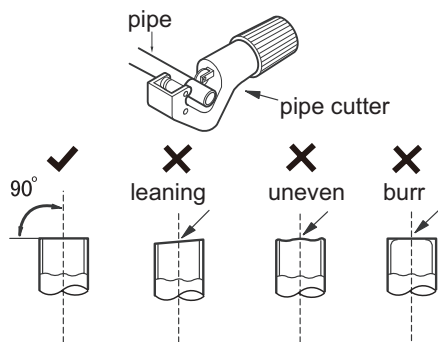

#### B: Remove the burrs

- Remove the burrs with shaper and prevent the burrs from getting into the pipe.

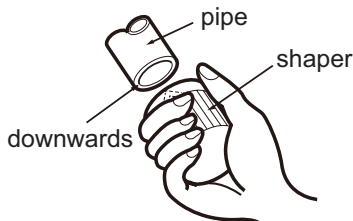

#### C: Put on suitable insulating pipe

#### D: Put on the union nut

- Remove the union nut on the indoor connection pipe and outdoor valve; install the union nut on the pipe.

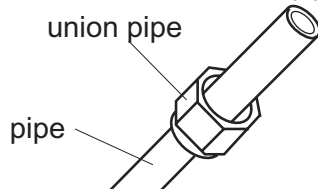

#### E: Expand the port

- Expand the port with expander.

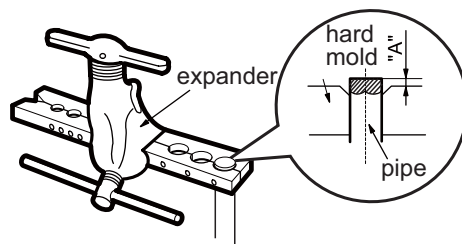

#### Note:

- "A" is different according to the diameter, please refer to the sheet below:

Outer diameter (mm)	A(mm)	
	Max	Min
Φ6 - 6.35(1/4")	1.3	0.7
Φ9.52(3/8")	1.6	1.0
Φ12-12.7(1/2")	1.8	1.0
Φ15.8-16(5/8")	2.4	2.2

#### F: Inspection

- Check the quality of expanding port. If there is any blemish, expand the port again according to the steps above.

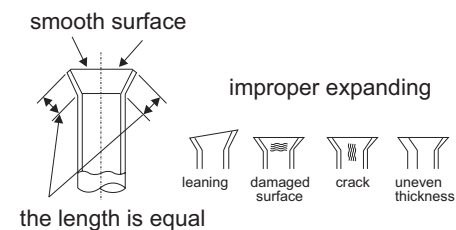

## Wired Controller (Optional)

If the product you bought is equipped with wired controller, please refer to the following introductions of wired controller.

### 1 Displaying Part

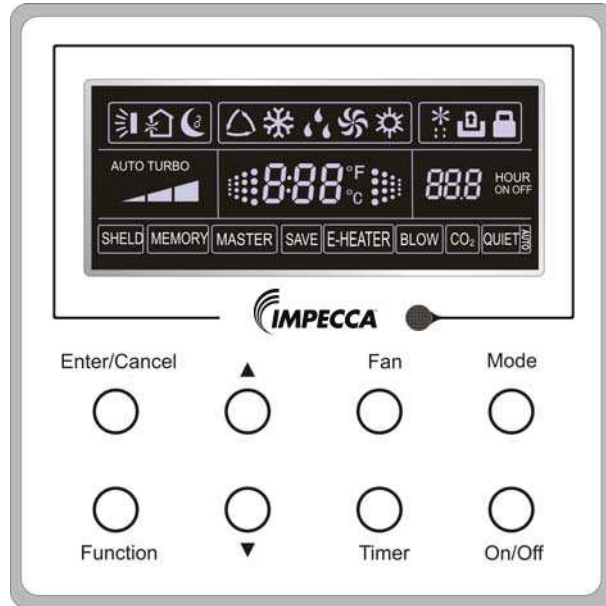

Fig1.1.1 Outline of wired controller

### 1.1 LCD Display of Wired Controller

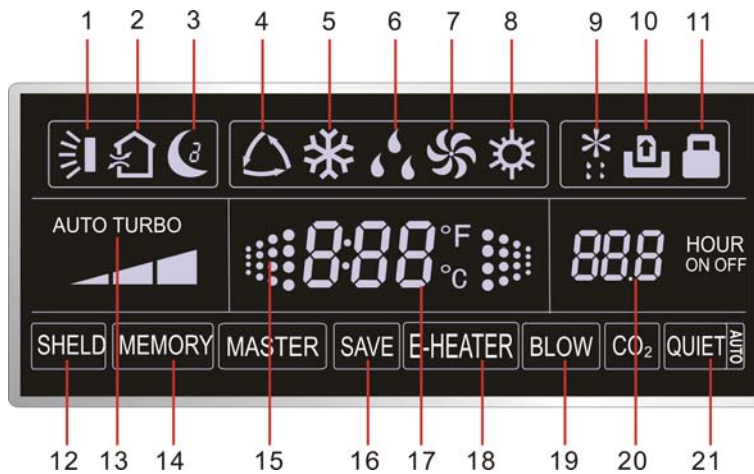















Fig.1.1.2 LCD display

## Wired Controller (Optional)

### 1.2 Instruction to LCD Display

Table 1.1

No.	Symbols	Description
1		Swing function
2		Air exchange function (this function is yet unavailable for this unit).
3		Sleep function (Only sleep 1).
4		Each kind of running mode of indoor unit (auto mode)
5		Cooling mode
6		Dry mode
7		Fan mode
8		Heating mode
9		Defrosting function for the outdoor unit.
10		Gate-control function (this function is yet unavailable for this unit).
11		Lock function.
12	SHIELD	Shield functions (Button operation, temperature setting, On/Off operation, Mode setting are disabled by the remote monitoring system.)
13	Turbo	Turbo function state
14	MEMORY	Memory function (The indoor unit resumes the original setting state after power failure and then power recovery).
15		It blinks under on state of the unit without operation of any button.
16	SAVE	Energy-saving function (this function is yet unavailable for this unit).
17		Ambient/setting temperature value
18	E-HEATER	Electric auxiliary heating function.
19	BLOW	Blow function.
20		Timing value.
21	QUIET	Quiet function (two types: quiet and auto quiet) (this function is yet unavailable for this unit).

## Wired Controller (Optional)

### 2 Buttons

#### 2.1 Layout of Buttons

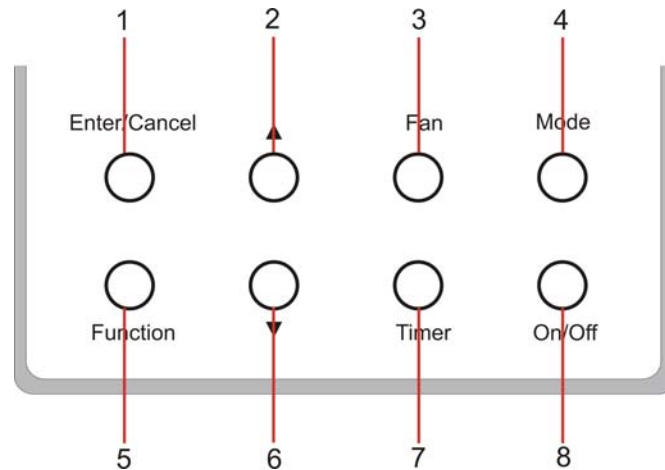

#### 2.2 Functions of Buttons

Table 2.1

No.	Name	Function
1	Enter/Cancel	Function selection and cancellation.
2	▲	① . Running temperature setting of the indoor unit, range:16~30°C.
6	▼	② . Timer setting, range:0.5-24 hr.
3	Fan	Setting of the high/middle/low/auto fan speed.
4	Mode	Setting of the Cooling/Heating/Fan/Dry/Auto mode of the indoor unit.
5	Function	Switchover among the functions of Turbo/Save/E-heater/Blow etc..
7	Timer	Timer setting.
8	On/Off	Turn on/off the indoor unit
4+2	▲+Mode	Press them for 5s under off state of the unit to enter/cancel the Memory function(If memory is set, indoor unit after power failure and then power recovery will resume the original setting state. If not, the indoor unit is defaulted to be off after power recovery. Memory off is default before delivery.).
3+6	Fan+▼	By pressing them at the same time under off state of the unit, ❄️ will be displayed on the wired controller for the cooling only unit, while 🔥 will be displayed on the wired controller for the cooling and heating unit.
2+6	▲+▼	Upon startup of the unit without malfunction or under off state of the unit,press them at the same time for 5s to enter the lock state, in which case,any other buttons won't respond the press. Repress them for 5s to quit this state.

# Wired Controller (Optional)

## 3 Operation Instructions

### 3.1 On/Off

Press On/Off to turn on the unit and turn it off by another press.

Note: The state shown in Fig.3.1.1 indicates the "Off" state of the unit after power on. The state shown in Fig.3.1.2 indicates the "On" state of the unit after power on.

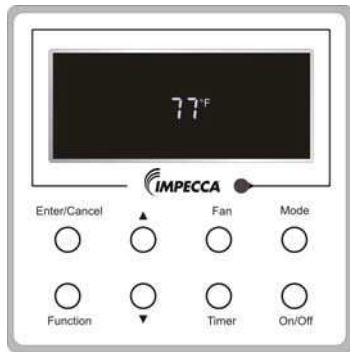

Fig.3.1.1 "Off" State

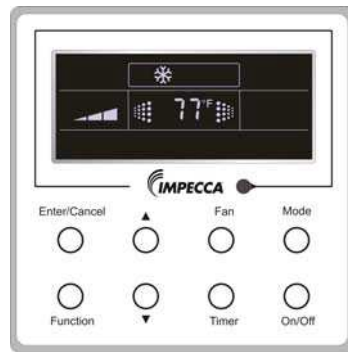
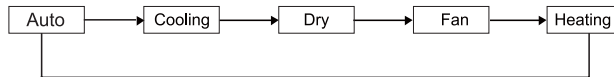

Fig.3.1.2 "On" State

### 3.2 Mode Setting

Under ON state of the unit, press the Mode to switch the operation modes as the following sequence: Auto–Cooling–Dry–Fan–Heating.



### 3.3 Temperature Setting

Press ▲ or ▼ to increase/decrease the preset temperature. If pressing either of them continuously, the temperature will be increased or decreased by 1°C every 0.5s, as shown in Fig.3.3.1.

In the Cooling, Dry, Fan or Heating mode, the temperature setting range is 16°C~30°C.

In the Auto mode, the setting temperature is unadjustable.

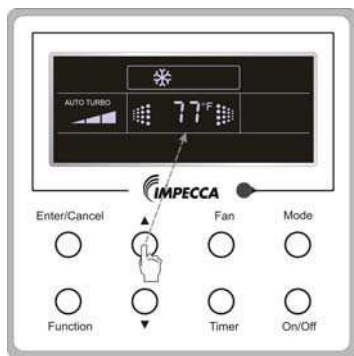

Fig.3.3.1

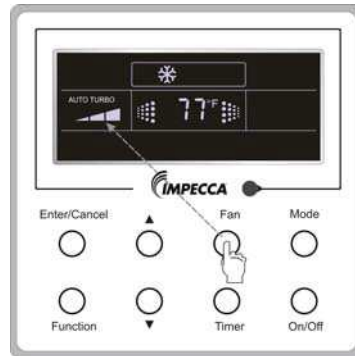

Fig.3.4.1



## Wired Controller (Optional)

### 3.4 Fan Setting

Under the "On" state of the unit, press Fan and then fan speed of the indoor unit will change circularly as shown in Fig.3.4.1.

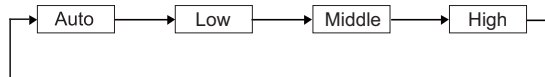

### 3.5 Timer Setting

Under on-state of the unit, Press Timer button to set timer off of the unit. Under off-state of the unit, press Timer button to set timer on of the unit in the same way.

- Timer on setting:

Under off-state of the unit without timer setting, if Timer button is pressed, LCD will display xx. Hour, with ON blinking. In this case, press ▲ or ▼ button to adjust timer on and then press Timer to confirm.

- Timer off setting:

Under on-state of the unit without timer setting, if Timer button is pressed, LCD will display xx. Hour, with OFF blinking. In this case, press ▲ or ▼ button to adjust timer on and then press Timer to confirm.

- Cancel timer:

After setting of timer, if Timer button is pressed, LCD won't display xx. Hour so that timer setting is canceled.

Timer off setting under the "On" state of the unit is shown as Fig.3.5.1.

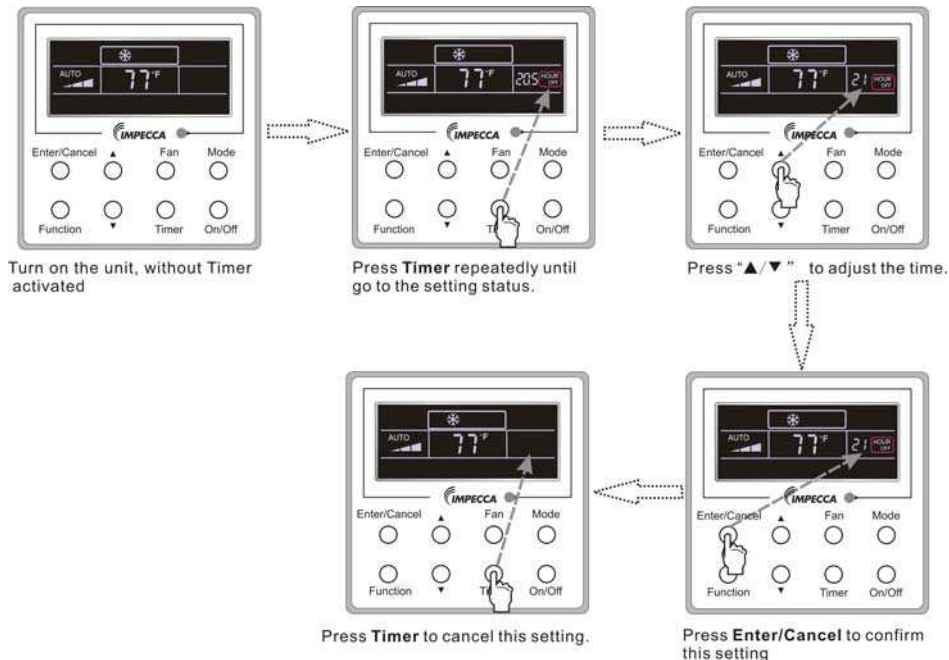

Fig.3.5.1 Timer off Setting under the "On" State of the Unit

## Wired Controller (Optional)

Timer on setting under the "Off" state of the unit is shown as Fig.3.5.2.

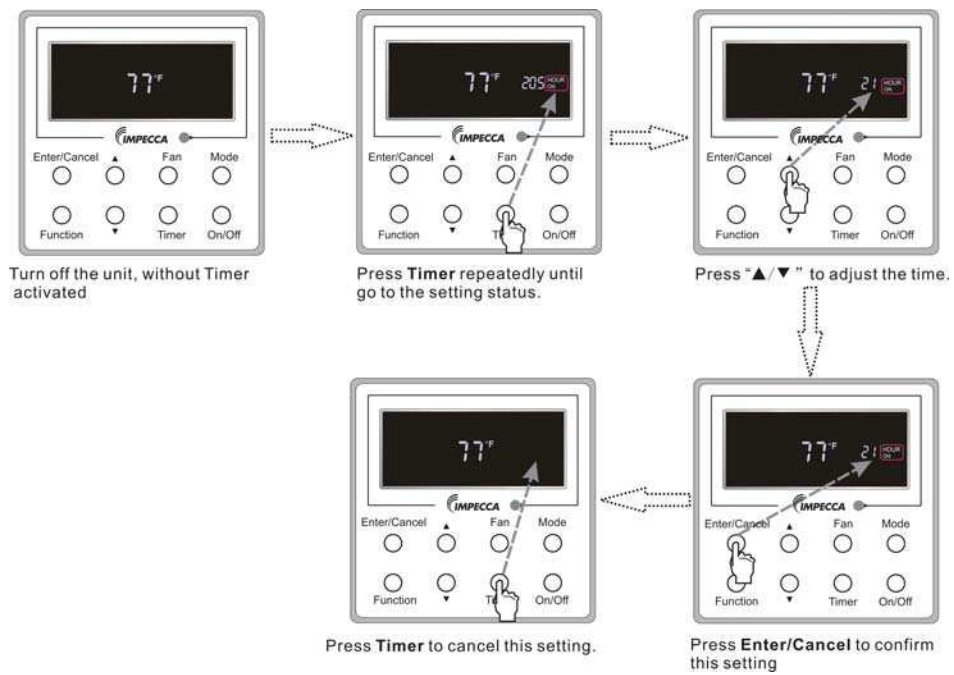



Fig.3.5.2 Timer on Setting under the "Off" State of the Unit

Timer range: 0.5-24hr. Every press of **▲** or **▼** will make the set time increased or decreased by 0.5hr. If either of them is pressed continuously, the set time will increase/ decrease by 0.5hr every 0.5s.

## Wired Controller (Optional)

### 3.6 Swing Setting

**Swing On:** Press **Function** under on state of the unit to activate the swing function. In this case,  will blink. After that, press **Enter/Cancel** to make a confirmation.

**Swing Off:** When the Swing function is on, press **Function** to enter the Swing setting interface, with  blinking. After that, press **Enter/Cancel** to cancel this function. Swing setting is shown as Fig.3.6.1.

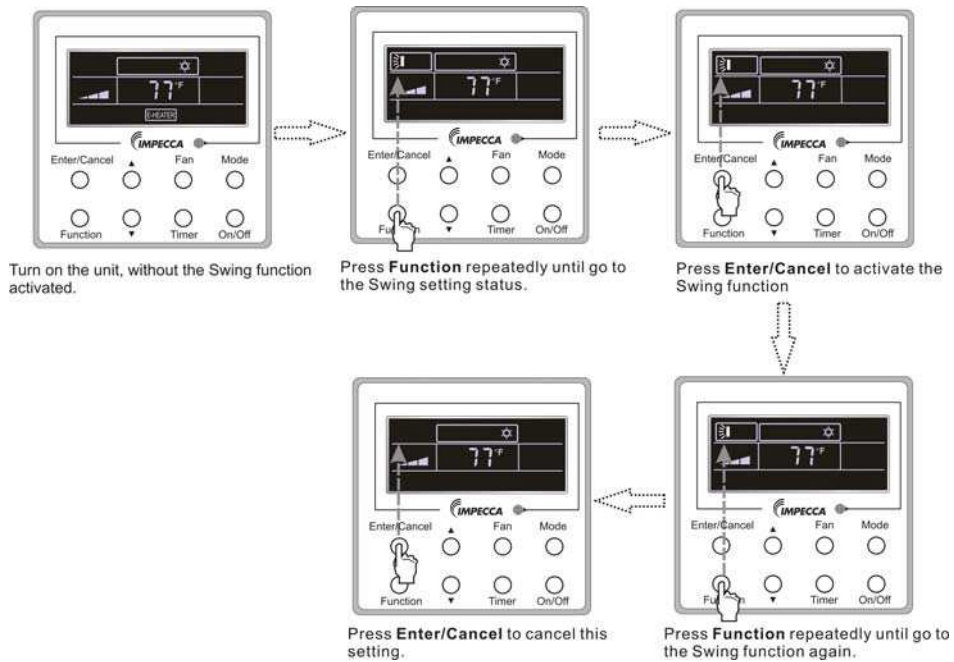

Fig.3.6.1 Swing Setting

Notes:

- ① . Sleep, Turbo or Blow setting is the same as the Swing setting.
- ② . After the setting has been done, it has to press the key "Enter/Cancel" to back to the setting status or quit automatically five seconds later.

## Wired Controller (Optional)

### 3.7 Sleep Setting

**Sleep on:** Press Function under the On state of the unit till the unit enters the Sleep setting state. After that, press Enter/Cancel to confirm this setting.

**Sleep off:** When the Sleep function is activated, press Function to enter the Sleep setting status. After that, press Enter/Cancel to cancel this function.

In the Cooling or Dry mode, the temperature will increase by 1°C after the unit runs under Sleep1 for 1hr and 1°C after another 1hr. After that, the unit will run at this temperature.

In the Heating mode, the temperature will decrease by 1°C after the unit runs under Sleep 1 for 1hr and 1°C after another 1hr. After that, the unit will run at this temperature.

Sleep setting is shown as Fig.3.7.1.

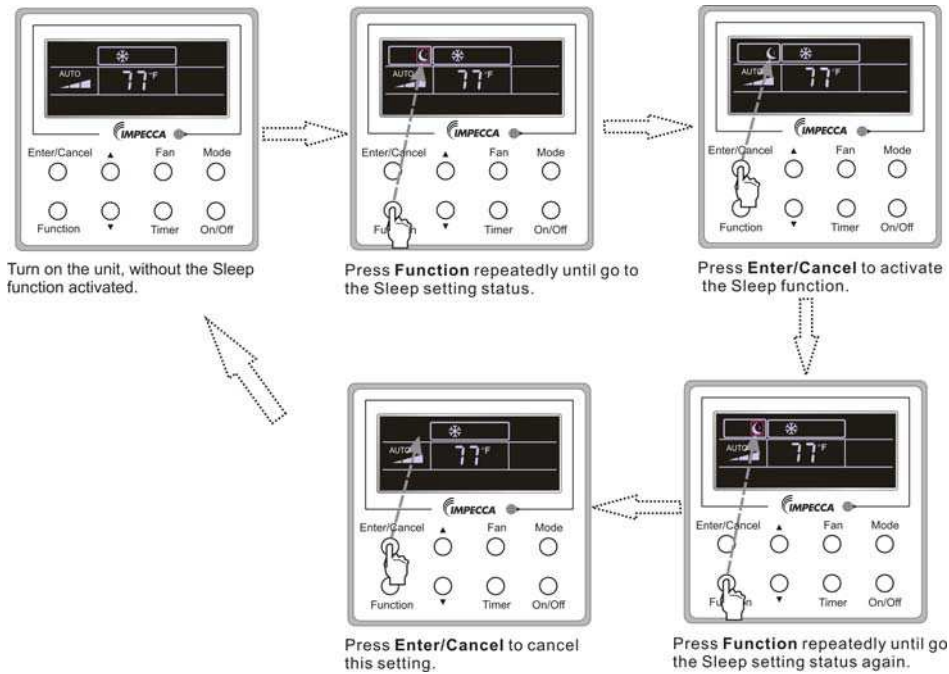

Fig.3.7.1. Sleep Setting

## Wired Controller (Optional)

### 3.8 Turbo Setting

Turbo function: The unit at the high fan speed can realize quick cooling or heating so that the room temperature can quickly approach the setting value.

In the Cooling or Heating mode, press **Function** till the unit enters the Turbo setting status and then press **Enter/Cancel** to confirm the setting.

When the Turbo function is activated, press **Function** to enter the Turbo setting status and then press **Enter/Cancel** to cancel this function.

Turbo function setting is as shown in Fig.3.8.1.

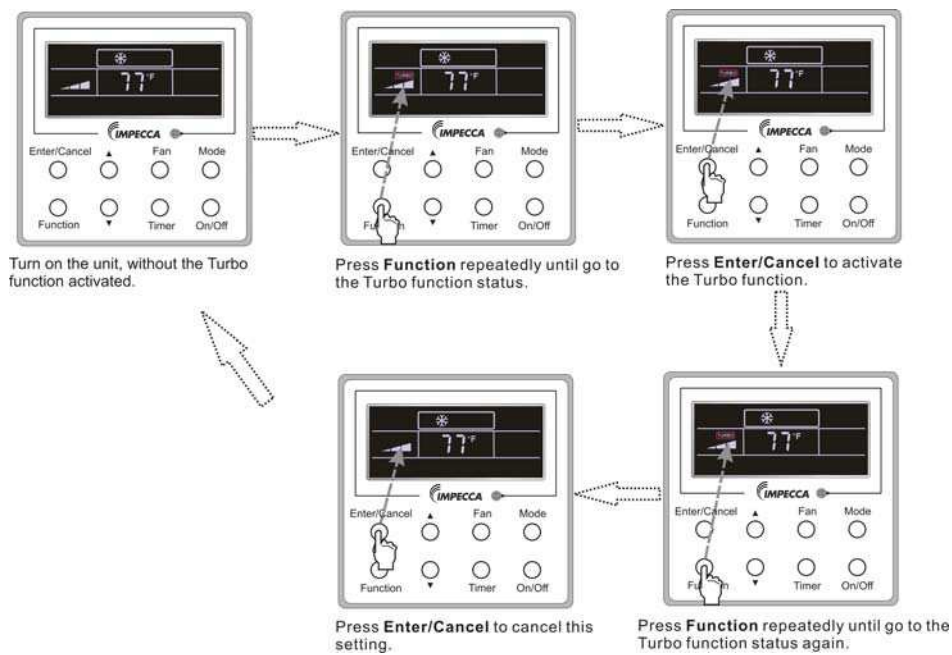

Fig.3.8.1 Turbo Setting

## Wired Controller (Optional)

### 3.9 E-heater Setting

E-heater (auxiliary electric heating function): In the Heating mode, E-heater is allowed to be turned on for improvement of efficiency.

Once the wired controller or the remote controller enters the Heating mode, this function will be turned on automatically.

Press **Function** in the Heating mode to enter the E-heater setting interface and then press **Enter/Cancel** to cancel this function.

Press **Function** to enter the E-heater setting status, if the E-heater function is not activated, and then press **Enter/Cancel** to activate it.

The setting of this function is shown as Fig.3.9.1 below:

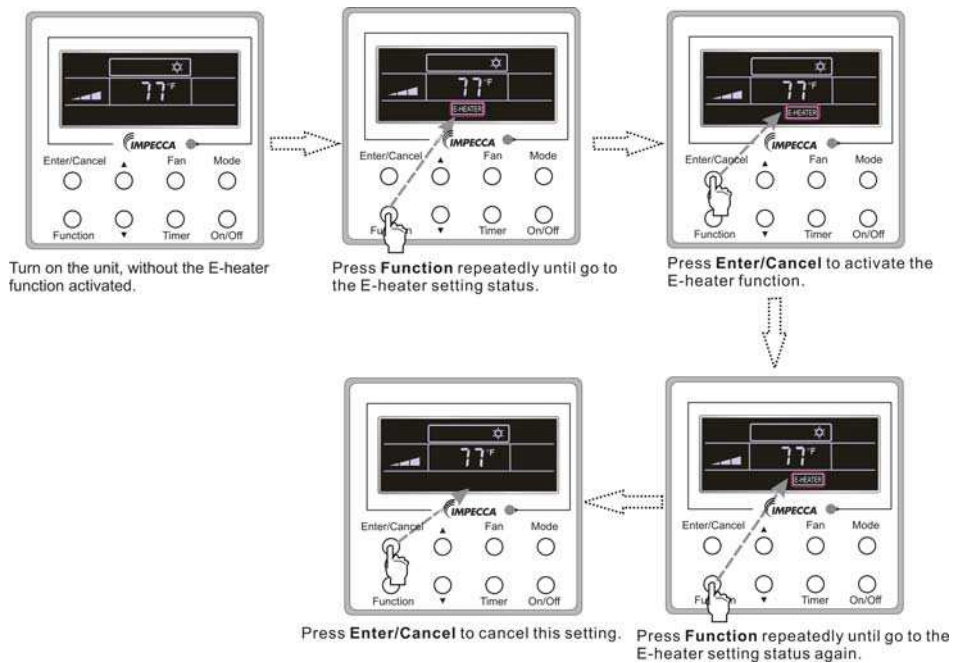

Fig.3.9.1 E-heater Setting

## Wired Controller (Optional)

### 3.10 Blow Setting

Blow function: After the unit is turned off, the water in evaporator of indoor unit will be automatically evaporated to avoid mildew.

In the Cooling or Dry mode, press **Function** till the unit enters the Blow setting status and then press **Enter/Cancel** to activate this function.

When the Blow function is activated, press **Function** to the Blow setting status and then press **Enter/Cancel** to cancel this function.

Blow function setting is as shown in Fig.3.10.1

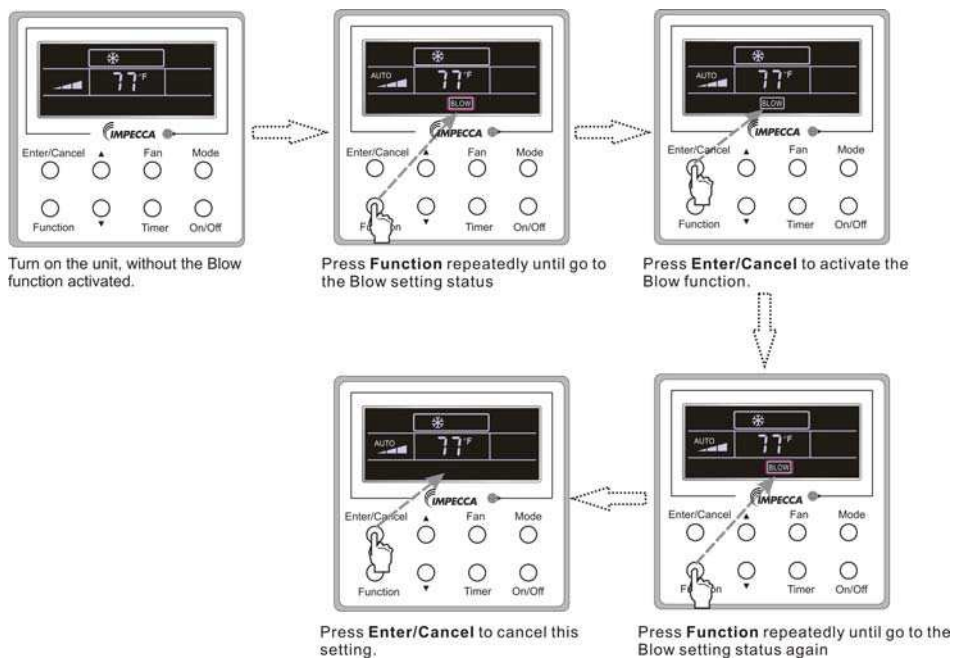

Fig.3.10.1 Blow Setting

#### Notes:

① . When the Blow function is activated, if turning off the unit by pressing **On/Off** or by the remote controller, the indoor fan will run at the low fan speed for 2 min, with "BLOW" displayed on the LCD. While, if the Blow function is deactivated, the indoor fan will be turned off directly.

② . Blow function is unavailable in the Fan or Heating mode.

## Wired Controller (Optional)

### 3.11 Other Functions

#### a. Lock

Upon startup of the unit without malfunction or under the "Off" state of the unit, press ▲ and ▼ at the same time for 5s till the wired controller enters the Lock function. In this case, LCD displays .

After that, repress these two buttons at the same time for 5s to quit this function.

Under the Lock state, any other button press won't get any response.

#### b. Memory

Memory switchover: Under the "Off" state of the unit, press Mode and ▲ at the same time for 5s to switch memory states between memory on and memory off. When this function is activated, Memory will be displayed. If this function is not set, the unit will be under the "Off" state after power failure and then power recovery.

Memory recovery: If this function has been set for the wired controller, the wired controller after power failure will resume its original running state upon power recovery. Memory contents: On/Off, Mode, set temperature, set fan speed and Lock function.

## 4 Installation and Dismantlement

### 4.1 Connection of the Signal Line of the Wired Controller

- Open the cover of the electric control box of the indoor unit.
- Let the single line of the wired controller through the rubber ring.
- Connect the signal line of the wired control to the 4-pin socket of the indoor unit PCB.
- Tighten the signal wire with ties.
- The communication distance between the main board and the wired controller can be up to 20 meters ( the standard distance is 8 meters)

### 4.2 Installation of the Wired Controller

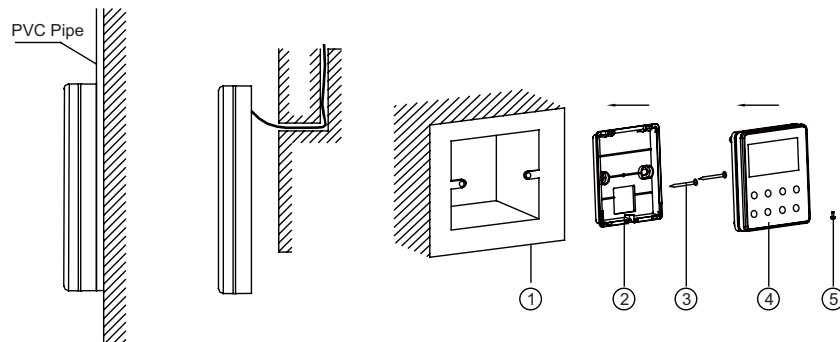

Fig.4.1 Accessories for the Installation of the Wired Controller

Table 4.1

No.	1	2	3	4	5
Name	Socket box embedded in the wall	Soleplate of the Wired Controller	Screw M4X25	Front Panel of the Wired Controller	Screw ST 2.9X6

## Wired Controller (Optional)

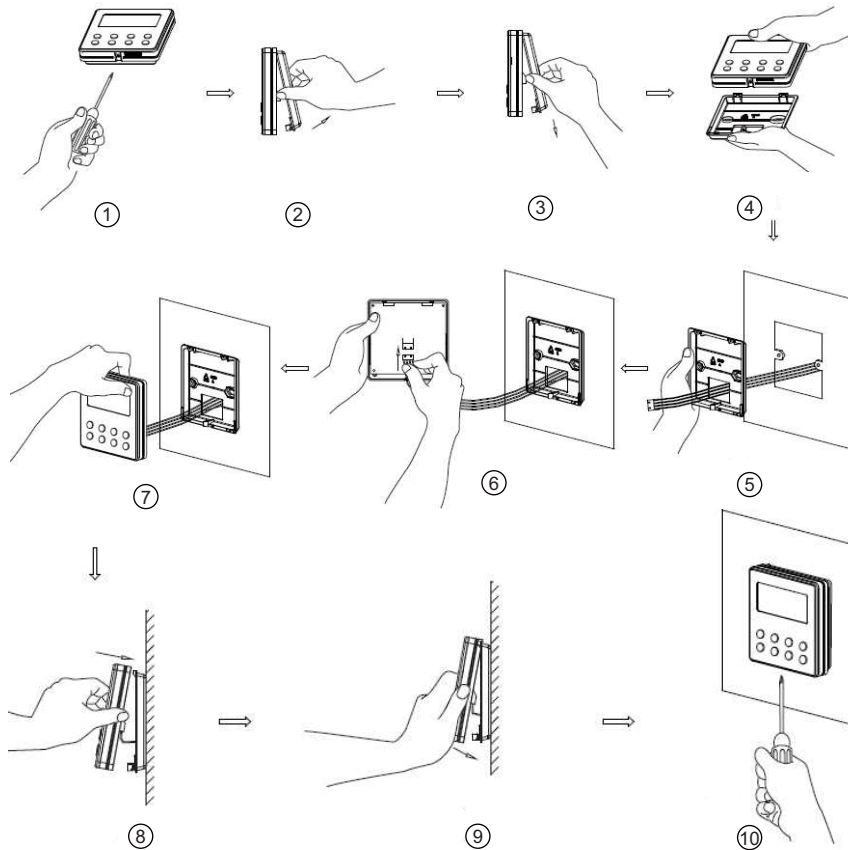

Fig.4.2

Fig.4.2 shows the installation steps of the wired controller, but there are some issues that need your attention.

1) Prior to the installation, please firstly cut off the power supply of the wire buried in the installation hole, that is, no operation is allowed with electricity during the whole installation.

2) Pull out the four-core twisted pair line from the installation holes and then let it go through the rectangular hole behind the soleplate of the wired controller.

3) Stick the soleplate of the wired controller to the wall over the installation hole and then fix it with screws M4X25.

4) Insert the four-core twisted pair line into the slot of the wired controller and then buckle the front panel and the soleplate of the wired controller together.

5) Finally, fix the front panel and the soleplate of the wired controller tightly by screws ST2.9X6.

### **⚠ CAUTION!**

Please pay special attention to the followings during the connection to avoid the malfunction of the air conditioning unit due to electromagnetic interference.

① . Separate the signal and communication lines of the wired controller from the power cord

## Wired Controller (Optional)

and connection lines between the indoor and outdoor unit, with a minimum interval of 20cm, otherwise the communication of the unit will probably work abnormally.

②. If the air conditioning unit is installed where is vulnerable to electromagnetic interference, then the signal and communication lines of the wired controller must be the shielding twisted pair lines.

### 4.3 Dismantlement of the Wired Controller

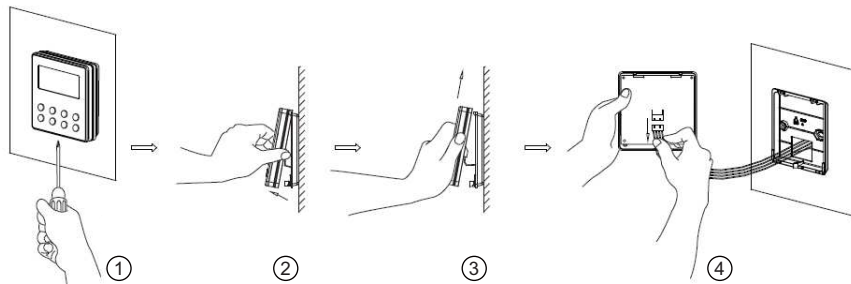

## 5 Errors Display

If there is an error occurring during the operation of the system, the error code will be displayed on the LCD, as show in Fig.5.1. If multi errors occur at the same time, their codes will be displayed circularly.

Note: In event of any error, please turn off the unit and contact the professionally skilled personnel.

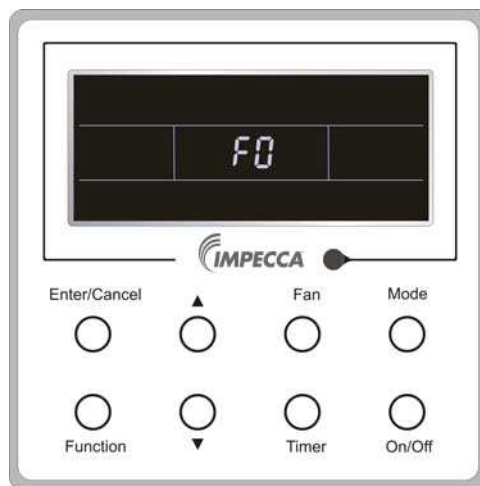

Fig.5.1

## Wired Controller (Optional)

Table 5.1 Meaning of Each Error

Error	Error Code	Error	Error Code
Return air temperature sensor open/ short circuited	F1	Drive board communication error	P6
evaporator temperature sensor open/ short circuited	F2	Compressor overheating protection	H3
Indoor unit liquid valve temperature sensor open/short circuited	b5	Indoor and outdoor units unmatched	LP
Indoor gas valve temperature sensor open/ short circuited	b7	Communication line misconnected or expansion valve error	dn
IPM temperature sensor open/short circuited	P7	Running mode conflict	E7
Outdoor ambient temperature sensor open/ short circuited	F3	Pump-down	Fo
Outdoor unit condenser mid-tube temperature sensor open/short circuited	F4	Jumper error	C5
Discharge temperature sensor open/ short circuited	F5	Forced defrosting	H1
Indoor and outdoor communication error	E6	Compressor startup failure	Lc
DC bus under-voltage protection	PL	High discharge temperature protection	E4
DC bus over-voltage protection	PH	Overload protection	E8
Compressor phase current sensing circuit error	U1	Whole unit over-current protection	E5
Compressor demagnetization protection	HE	Over phase current protection	P5
PFC protection	Hc	Compressor desynchronizing	H7
IPM Temperature Protection	P8	IPM Current protection	H5
Over-power protection	L9	Compressor phase loss/reversal protection	Ld
System charge shortage or blockage protection	F0	Frequency restricted/reduced with whole unit current protection	F8
Capacitor charging error	PU	Frequency restricted/reduced with IPM current protection	En
High pressure protection	E1	Frequency restricted/reduced with high discharge temperature	F9
Low pressure protection	E3	Frequency restricted/reduced with anti-freezing protection	FH
Compressor stalling	LE	Frequency restricted/reduced with overload protection	F6
Over-speeding	LF	Frequency restricted/reduced with IPM temperature protection	EU
Drive board temperature sensor error	PF	Indoor unit full water error	E9
AC contactor protection	P9	Anti-freezing protection	E2
Temperature drift protection	PE	AC input voltage abnormal	PP
Sensor connection protection	Pd	Whole unit current sensing circuit error	U5
DC bus voltage drop error	U3	4-way valve reversing error	U7
Outdoor fan 1 error protection	L3	Motor stalling	H6
Outdoor fan 2 error protection	LA	PG motor zero-crossing protection	U8

# CUSTOMER SUPPORT

Before contacting customer support, please see the troubleshooting guide above.  
Visit our website to contact us, find answers to Frequently Asked Questions, and for other resources which may include an updated version of this user's guide.

 **WWW.IMPECCA.COM**

If you wish to contact us by phone, please be sure to have your model number and serial number ready and call us between 9:00am and 6:00pm ET, at +1 866-954-4440.

Keep tabs on Impecca's newest innovations & enter contests via our social network feeds:

 [www.facebook.com/Impecca/](https://www.facebook.com/Impecca/)

 [www.instagram.com/Impecca/](https://www.instagram.com/Impecca/)

 [@impeccausa](https://twitter.com/impeccausa)





Split Air Conditioner   
Models:  
ISMI-W182  
ISMI-W242

Thank you for choosing our product.  
For proper operation, please read and keep this manual carefully.  
If you have lost the Owner's Manual, please contact the local agent or visit  
[www.impecca.com](http://www.impecca.com) for electronic version.

# Content

## Operation Notices

Precautions.....	1
Parts Name.....	6

## Screen Operation Guide

Buttons on remote controller .....	7
Introduction for icons on display screen .....	7
Introduction for buttons on remote controller.....	8
Function introduction for combination buttons.....	12
Operation guide .....	13
Replacement of batteries in remote controller.....	13
Emergency operation .....	14

## Maintenance

Clean and Maintenance.....	14
----------------------------	----

## Malfunction

Malfunction analysis .....	17
----------------------------	----

## Installation Notice

Installation dimension diagram .....	21
Tools for installation.....	22
Selection of installation location .....	22
Requirements for electric connection .....	23

## Installation

Installation of indoor unit.....	24
Check after installation .....	29

## Test and operation

Test operation.....	29
---------------------	----

## Attachment

Configuration of connection pipe .....	30
Pipe expanding method.....	32
Wired Controller.....	33

This appliance is not intended for use by persons (including children) with reduced physical, sensory or mental capabilities or lack of experience and knowledge, unless they have been given supervision or instruction concerning use of the appliance by a person responsible for their safety. Children should be supervised to ensure they are away from the appliance.

## Explanation of Symbols

---



Indicates a hazardous situation that, if not avoided, will result in death or serious injury.



Indicates a hazardous situation that, if not avoided, could result in death or serious injury.

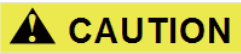

Indicates a hazardous situation that, if not avoided, may result in minor or moderate injury.



Indicates important but not hazard-related information, used to indicate risk of property damage.



Indicates a hazard that would be assigned a signal word WARNING or CAUTION.

## Precautions



### WARNING

#### **Operation and Maintenance**

- This appliance can be used by children aged from 8 years and above and persons with reduced physical, sensory or mental capabilities or lack of experience and knowledge if they have been given supervision or instruction concerning use of the appliance in a safe way and understand the hazards involved.
- Children shall not play with the appliance.
- Cleaning and user maintenance shall not be made by children without supervision.
- Do not connect air conditioner to multi-purpose socket. Otherwise, it may cause fire hazard.
- Do disconnect power supply when cleaning air conditioner. Otherwise, it may cause electric shock.
- If the supply cord is damaged, it must be replaced by the manufacturer, its service agent or similarly qualified persons in order to avoid a hazard.
- Do not wash the air conditioner with water to avoid electric shock.
- Do not spray water on indoor unit. It may cause electric shock or malfunction.
- After removing the filter, do not touch fins to avoid injury.
- Do not use fire or hair dryer to dry the filter to avoid deformation or fire hazard.

## Precautions



### WARNING

- Maintenance must be performed by qualified professionals. Otherwise, it may cause personal injury or damage.
- Do not repair air conditioner by yourself. It may cause electric shock or damage. Please contact dealer when you need to repair air conditioner.
- Do not extend fingers or objects into air inlet or air outlet. It may cause personal injury or damage.
- Do not block air outlet or air inlet. It may cause malfunction.
- Do not spill water on the remote controller, otherwise the remote controller may be broken.
- When below phenomenon occurs, please turn off air conditioner and disconnect power immediately, and then contact the dealer or qualified professionals for service.
  - Power cord is overheating or damaged.
  - There's abnormal sound during operation.
  - Circuit break trips off frequently.
  - Air conditioner gives off burning smell.
  - Indoor unit is leaking.
- If the air conditioner operates under abnormal conditions, it may cause malfunction, electric shock or fire hazard.
- When turning on or turning off the unit by emergency operation switch, please press this switch with an insulating object other than metal.
- Do not step on top panel of outdoor unit, or put heavy objects. It may cause damage or personal injury.

## Precautions



### WARNING

#### Attachment

- Installation must be performed by qualified professionals. Otherwise, it may cause personal injury or damage.
- Must follow the electric safety regulations when installing the unit.
- According to the local safety regulations, use qualified power supply circuit and circuit break.
- Do install the circuit break. If not, it may cause malfunction.
- An all-pole disconnection switch having a contact separation of at least 3mm in all poles should be connected in fixed wiring.
- Including an circuit break with suitable capacity, please note the following table. Air switch should be included magnet buckle and heating buckle function, it can protect the circuit-short and overload.
- Air Conditioner should be properly grounded. Incorrect grounding may cause electric shock.
- Don't use unqualified power cord.
- Make sure the power supply matches with the requirement of air conditioner. Unstable power supply or incorrect wiring or malfunction. Please install proper power supply cables before using the air conditioner.
- Properly connect the live wire, neutral wire and grounding wire of power socket.
- Be sure to cut off the power supply before proceeding any work related to electricity and safety.

## Precautions



### WARNING

- Do not put through the power before finishing installation.
- If the supply cord is damaged, it must be replaced by the manufacturer, its service agent or similarly qualified persons in order to avoid a hazard.
- The temperature of refrigerant circuit will be high, please keep the interconnection cable away from the copper tube.
- The appliance shall be installed in accordance with national wiring regulations.
- Installation must be performed in accordance with the requirement of NEC and CEC by authorized personnel only.
- The air conditioner is the first class electric appliance. It must be properly grounding with specialized grounding device by a professional. Please make sure it is always grounded effectively, otherwise it may cause electric shock.
- The yellow-green wire in air conditioner is grounding wire, which can't be used for other purposes.
- The grounding resistance should comply with national electric safety regulations.
- The appliance must be positioned so that the plug is accessible.
- All wires of indoor unit and outdoor unit should be connected by a professional.
- If the length of power connection wire is insufficient, please contact the supplier for a new one. Avoid extending the wire by yourself.

## Precautions



### WARNING

- For the air conditioner with plug, the plug should be reachable after finishing installation.
- For the air conditioner without plug, an circuit break must be installed in the line.
- If you need to relocate the air conditioner to another place, only the qualified person can perform the work. Otherwise, it may cause personal injury or damage.
- Select a location which is out of reach for children and far away from animals or plants. If it is unavoidable, please add the fence for safety purpose.
- The indoor unit should be installed close to the wall.
- Instructions for installation and use of this product are provided by the manufacturer.

### Working temperature range

	Indoor side DB/WB(°C )	Outdoor side DB/WB(°C )
Maximum cooling	26.7/19.4	46.1/23.9
Maximum heating	26.7/-	23.9/18.3

#### **NOTICE:**

- The operating temperature range (outdoor temperature) for cooling only unit is 18.3 °C ~46.1 °C ; for heat pump unit is -7 °C ~ 46.1 °C .

## Parts Name

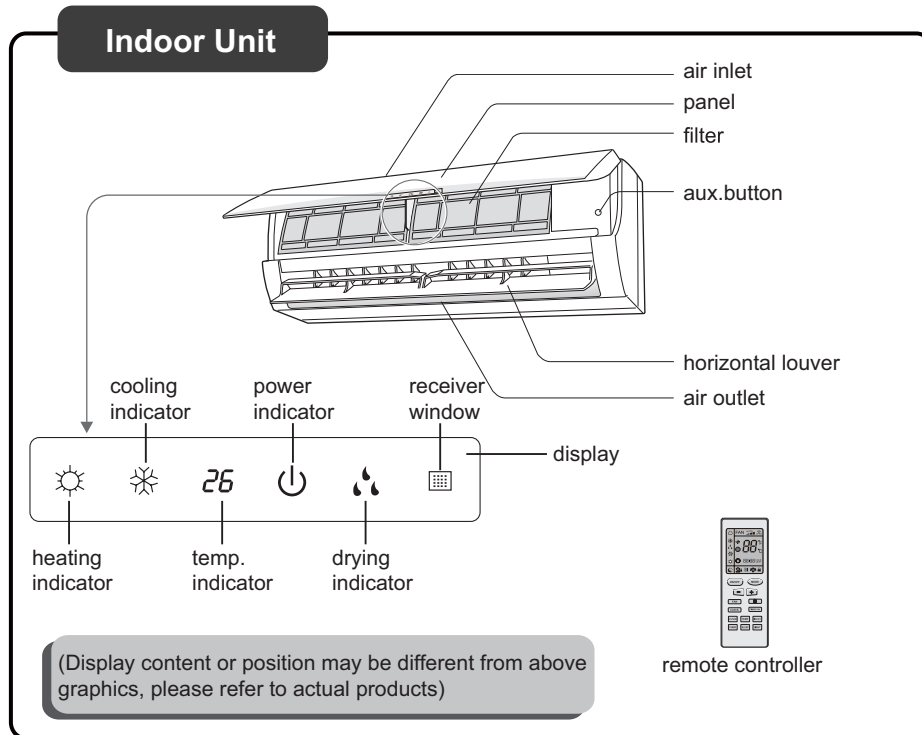

### **NOTICE:**

Actual product may be different from above graphics, please refer to actual products.

## Buttons on remote controller

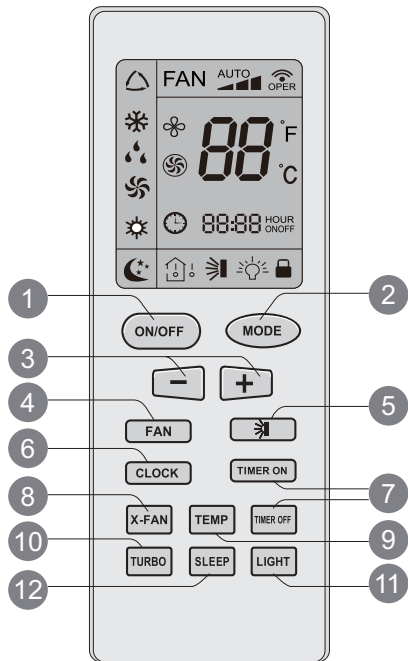

- 1 ON/OFF button
- 2 MODE button
- 3 +/- button
- 4 FAN button
- 5 button
- 6 CLOCK button
- 7 TIMER ON/TIMER OFF button
- 8 X-FAN button  
Note: X-FAN is the same with BLOW
- 9 TEMP button
- 10 TURBO button
- 11 LIGHT button
- 12 SLEEP button

## Introduction for icons on display screen

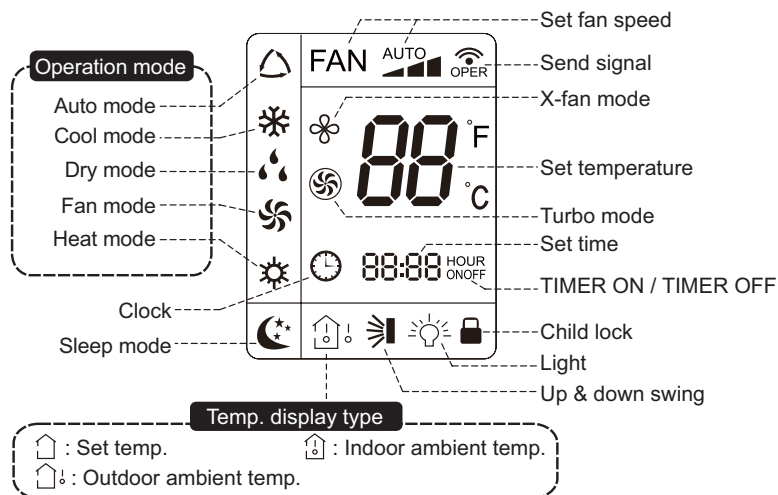

## Introduction for buttons on remote controller

### Note:

- After putting through the power, the air conditioner will give out a sound. Operation indicator "⏻" is ON (red indicator). After that, you can operate the air conditioner by using remote controller.

### 1 ON/OFF button

Press this button can turn on or turn off the air conditioner. After turning on the air conditioner, operation indicator "⏻" on indoor unit's display is ON (green indicator. The colour is different for different models), and indoor unit will give out a sound.

### 2 MODE button

Press this button to select your required operation mode.



- When selecting auto mode, air conditioner will operate automatically according to ex-factory setting. Set temperature can't be adjusted and will not be displayed as well. Press "FAN" button can adjust fan speed. Press "↗" button can adjust fan blowing angle.
- After selecting cool mode, air conditioner will operate under cool mode. Cool indicator "❄" on indoor unit is ON. Press "+" or "-" button to adjust set temperature. Press "FAN" button to adjust fan speed. Press "↗" button to adjust fan blowing angle.
- When selecting dry mode, the air conditioner operates at low speed under dry mode. Dry indicator "💧" on indoor unit is ON. Under dry mode, fan speed can't be adjusted. Press "↗" button to adjust fan blowing angle.
- When selecting fan mode, the air conditioner will only blow fan, no cooling and no heating. All indicators are OFF. Press "FAN" button to adjust fan speed. Press "↗" button to adjust fan blowing angle.
- When selecting heating mode, the air conditioner operates under heat mode. Heat indicator "☀" on indoor unit is ON. Press "+" or "-" button to adjust set temperature. Press "FAN" button to adjust fan speed. Press "↗" button to adjust fan blowing angle. (Cooling only unit won't receive heating mode signal. If setting heat mode with remote controller, press ON/OFF button can't start up the unit).

### Note:

- For preventing cold air, after starting up heating mode, indoor unit will delay 1~5 minutes to blow air (actual delay time is depend on indoor ambient temperature).
- Set temperature range from remote controller: 16~30°C ; Fan speed: auto, low speed, medium speed, high speed.

## Introduction for buttons on remote controller

### 3 +/- button

- Press "+" or "-" button once increase or decrease set temperature 1°C . Holding "+" or "-" button, 2s later, set temperature on remote controller will change quickly. On releasing button after setting is finished, temperature indicator on indoor unit will change accordingly. (Temperature can't be adjusted under auto mode)
- When setting TIMER ON, TIMER OFF or CLOCK, press "+" or "-" button to adjust time. (Refer to CLOCK, TIMER ON, TIMER OFF buttons) When setting TIMER ON, TIMER OFF or CLOCK, press "+" or "-" button to adjust time. (Refer to CLOCK, TIMER ON, TIMER OFF buttons)

### 4 FAN button

Pressing this button can set fan speed circularly as: auto (AUTO), low(▲), medium (▲▲), high(▲▲▲).



#### Note:

- Under AUTO speed, air conditioner will select proper fan speed automatically according to ex-factory setting.
- Fan speed under dry mode is low speed.

### 5 Fan swing button

Press this button can select up&down swing angle. Fan blow angle can be selected circularly as below:

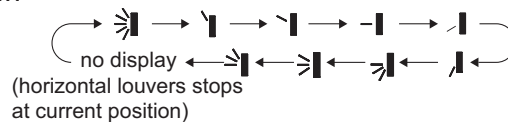

- When selecting "no display", air conditioner is blowing fan automatically. Horizontal louver will automatically swing up & down at maximum angle.
- When selecting "fan with vertical line", "fan with horizontal line", "fan with diagonal line", "fan with horizontal line", "fan with vertical line", air conditioner is blowing fan at fixed position. Horizontal louver will stop at the fixed position.
- When selecting "fan with diagonal line", "fan with vertical line", "fan with horizontal line", air conditioner is blowing fan at fixed angle. Horizontal louver will send air at the fixed angle.
- Hold "fan with diagonal line" button above 2s to set your required swing angle. When reaching your required angle, release the button.

#### Note:

- "fan with diagonal line", "fan with vertical line", "fan with horizontal line" may not be available. When air conditioner receives this signal, the air conditioner will blow fan automatically.

## Introduction for buttons on remote controller

### 6 CLOCK button

Press this button to set clock time. "🕒" icon on remote controller will blink. Press "+" or "-" button within 5s to set clock time. Each pressing of "+" or "-" button, clock time will increase or decrease 1 minute. If hold "+" or "-" button, 2s later, time will change quickly. Release this button when reaching your required time. Press "CLOCK" button to confirm the time. "🕒" icon stops blinking.

#### Note:

- Clock time adopts 24-hour mode.
- The interval between two operation can't exceeds 5s. Otherwise, remote controller will quit setting status. Operation for TIMER ON/TIMER OFF is the same.

### 7 TIMER ON / TIMER OFF button

- TIMER ON button

"TIMER ON" button can set the time for timer on. After pressing this button, "🕒" icon disappears and the word "ON" on remote controller blinks. Press "+" or "-" button to adjust TIMER ON setting. After each pressing "+" or "-" button, TIMER ON setting will increase or decrease 1min. Hold "+" or "-" button, 2s later, the time will change quickly until reaching your required time.

Press "TIMER ON" to confirm it. The word "ON" will stop blinking. "🕒" icon resumes displaying. Cancel TIMER ON: Under the condition that TIMER ON is started up, press "TIMER ON" button to cancel it.

- TIMER OFF button

"TIMER OFF" button can set the time for timer off. After pressing this button, "🕒" icon disappears and the word "OFF" on remote controller blinks. Press "+" or "-" button to adjust TIMER OFF setting. After each pressing "+" or "-" button, TIMER OFF setting will increase or decrease 1min. Hold "+" or "-" button, 2s later, the time will change quickly until reaching your required time.

Press "TIMER OFF" word "OFF" will stop blinking. "🕒" icon resumes displaying. Cancel TIMER OFF. Under the condition that TIMER OFF is started up, press "TIMER OFF" button to cancel it.

#### Note:

- Under on and off status, you can set TIMER OFF or TIMER ON simultaneously.
- Before setting TIMER ON or TIMER OFF, please adjust the clock time.
- After starting up TIMER ON or TIMER OFF, set the constant circulating valid. After that, air conditioner will be turned on or turned off according to setting time. ON/OFF button has no effect on setting. If you don't need this function, please use remote controller to cancel it.

## Introduction for buttons on remote controller

### 8 X-FAN button

Press this button under cool and dry mode to start up x-fan function, and "☼" icon on remote controller will be displayed. Press this button again to cancel x-fan function, and "☼" icon will disappear.

#### Note:

- When x-fan function is on, if the air conditioner is turned off, indoor fan will still operate at low speed for a while to blow the residual water inside the air duct.
- During x-fan operation, press X-FAN button to turn off x-fan function. Indoor fan will stop operation immediately.

### 9 TEMP button

By pressing this button, you can see indoor set temperature, indoor ambient temperature or outdoor ambient temperature on indoor unit's display. The setting on remote controller is selected circularly as below:

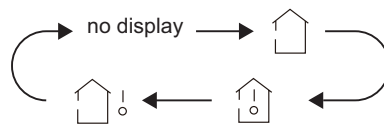

- When selecting "🏠" or no display with remote controller, temperature indicator on indoor unit displays set temperature.
- When selecting "🏠☀️" with remote controller, temperature indicator on indoor unit displays indoor ambient temperature.
- When selecting "🏠☀️☁️" with remote controller, temperature indicator on indoor unit displays outdoor ambient temperature.

#### Note:

- Outdoor temperature display is not available for some models. At that time, indoor unit receives "🏠☀️" signal, while it displays indoor set temperature.
- It's defaulted to display set temperature when turning on the unit. There is no display in the remote controller.
- Only for the models whose indoor unit has dual-8 display.
- When selecting displaying of indoor or outdoor ambient temperature, indoor temperature indicator displays corresponding temperature and automatically turn to display set temperature after three or five seconds.

### 10 TURBO button

Under COOL or HEAT mode, press this button to turn to quick COOL or quick HEAT mode. "⚡" icon is displayed on remote controller. Press this button again to exit turbo function and "⚡" icon will disappear.

## Introduction for buttons on remote controller

### 11 SLEEP button

Under COOL, HEAT or DRY mode, press this button to start up sleep function. "☾" icon is displayed on remote controller. Press this button again to cancel sleep function and "☾" icon will disappear.

### 12 LIGHT button

Press this button to turn off display light on indoor unit. "☹" icon on remote controller disappears. Press this button again to turn on display light. "☹" icon is displayed.

## Function introduction for combination buttons

### Child lock function

Press "+" and "-" simultaneously to turn on or turn off child lock function. When child lock function is on, "🔒" icon is displayed on remote controller. If you operate the remote controller, the "🔒" icon will blink three times without sending signal to the unit.

### Temperature display switchover function

Under OFF status, press "-" and "MODE" buttons simultaneously to switch temperature display between °C and °F .

## Operation guide

1. After putting through the power, press "ON/OFF" button on remote controller to turn on the air conditioner.
2. Press "MODE" button to select your required mode: AUTO, COOL, DRY, FAN, HEAT.
3. Press "+" or "-" button to set your required temperature. (Temperature can't be adjusted under auto mode).
4. Press "FAN" button to set your required fan speed: auto, low, medium and high speed.
5. Press "↻" button to select fan blowing angle.

## Replacement of batteries in remote controller

1. Press the back side of remote controller marked with "OPEN", as shown in the fig, and then push out the cover of battery box along the arrow direction.
2. Replace two 7# (AAA 1.5V) dry batteries, and make sure the position of "+" polar and "-" polar are correct.
3. Reinstall the cover of battery box.

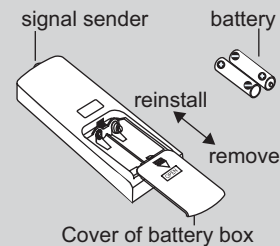

### NOTICE

- During operation, point the remote control signal sender at the receiving window on indoor unit.
- The distance between signal sender and receiving window should be no more than 8m, and there should be no obstacles between them.
- Signal may be interfered easily in the room where there is fluorescent lamp or wireless telephone; remote controller should be close to indoor unit during operation.
- Replace new batteries of the same model when replacement is required.
- When you don't use remote controller for a long time, please take out the batteries.
- If the display on remote controller is fuzzy or there's no display, please replace batteries.

## Emergency operation

If remote controller is lost or damaged, please use auxiliary button to turn on or turn off the air conditioner. The operation in details are as below:  
As shown in the fig. Open panel, press aux. button to turn on or turn off the air conditioner. When the air conditioner is turned on, it will operate under auto mode.

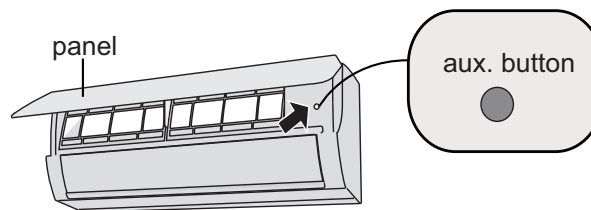

### **⚠ WARNING:**

Use insulated object to press the auto button

## Clean and Maintenance

### **⚠ WARNING**

- Turn off the air conditioner and disconnect the power before cleaning the air conditioner to avoid electric shock.
- Do not wash the air conditioner with water to avoid electric shock.
- Do not use volatile liquid to clean the air conditioner.

### **Clean surface of indoor unit**

When the surface of indoor unit is dirty, it is recommended to use a soft dry cloth or wet cloth to wipe it.

### **NOTICE:**

- Do not remove the panel when cleaning it.

## Clean and Maintenance

### Clean filter

- 1 Open panel**  
Pull out the panel to a certain angle as shown in the fig.

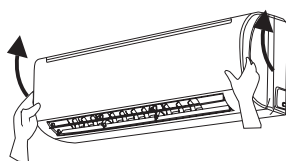

- 2 Remove filter**  
Remove the filter as indicated in the fig.

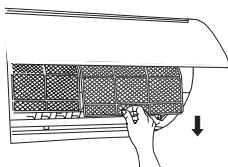

- 3 Clean filter**
- Use dust catcher or water to clean the filter.
  - When the filter is very dirty, use the water (below 45°C ) to clean it, and then put it in a shady and cool place to dry.

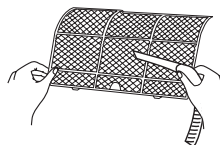

- 4 Install filter**  
Install the filter and then close the panel cover tightly.



### WARNING

- The filter should be cleaned every three months. If there is much dust in the operation environment, clean frequency can be increased.
- After removing the filter, do not touch fins to avoid injury.
- Do not use fire or hair dryer to dry the filter to avoid deformation or fire hazard.

## Clean and maintenance

### **NOTICE: Checking before use-season**

1. Check whether air inlets and air outlets are blocked.
2. Check whether circuit break, plug and socket are in good condition.
3. Check whether filter is clean.
4. Check whether mounting bracket for outdoor unit is damaged or corroded.  
If yes, please contact dealer.
5. Check whether drainage pipe is damaged.

### **NOTICE: Checking after use-season**

1. Disconnect power supply.
2. Clean filter and indoor unit's panel.
3. Check whether mounting bracket for outdoor unit is damaged or corroded.  
If yes, please contact dealer.

### **Notice for recovery**

1. Many packing materials are recyclable materials.  
Please dispose them in appropriate recycling unit.
2. If you want to dispose the air conditioner, please contact local dealer or consultant service center for the correct disposal method.

## Malfuction analysis

### General phenomenon analysis

Please check below items before asking for maintenance. If the malfunction still can't be eliminated, please contact local dealer or qualified professionals.

Phenomenon	Check items	Solution
Indoor unit can't receive remote controller's signal or remote controller has no action.	<ul style="list-style-type: none"> <li>Whether it's interfered severely (such as static electricity, stable voltage)?</li> </ul>	<ul style="list-style-type: none"> <li>Pull out the plug. Reinsert the plug after about 3min, and then turn on the unit again.</li> </ul>
	<ul style="list-style-type: none"> <li>Whether remote controller is within the signal receiving range?</li> </ul>	<ul style="list-style-type: none"> <li>Signal receiving range is 8m.</li> </ul>
	<ul style="list-style-type: none"> <li>Whether there are obstacles?</li> </ul>	<ul style="list-style-type: none"> <li>Remove obstacles.</li> </ul>
	<ul style="list-style-type: none"> <li>Whether remote controller is pointing at the receiving window?</li> </ul>	<ul style="list-style-type: none"> <li>Select proper angle and point the remote controller at the receiving window on indoor unit.</li> </ul>
	<ul style="list-style-type: none"> <li>Is sensitivity of remote controller low; fuzzy display and no display?</li> </ul>	<ul style="list-style-type: none"> <li>Check the batteries. If the power of batteries is too low, please replace them.</li> </ul>
	<ul style="list-style-type: none"> <li>No display when operating remote controller?</li> </ul>	<ul style="list-style-type: none"> <li>Check whether remote controller appears to be damaged. If yes, replace it.</li> </ul>
	<ul style="list-style-type: none"> <li>Fluorescent lamp in room?</li> </ul>	<ul style="list-style-type: none"> <li>Take the remote controller close to indoor unit.</li> <li>Turn off the fluorescent lamp and then try it again.</li> </ul>
No air emitted from indoor unit	<ul style="list-style-type: none"> <li>Air inlet or air outlet of indoor unit is blocked?</li> </ul>	<ul style="list-style-type: none"> <li>Eliminate obstacles.</li> </ul>
	<ul style="list-style-type: none"> <li>Under heating mode, indoor temperature is reached to set temperature?</li> </ul>	<ul style="list-style-type: none"> <li>After reaching to set temperature, indoor unit will stop blowing out air.</li> </ul>
	<ul style="list-style-type: none"> <li>Heating mode is turned on just now?</li> </ul>	<ul style="list-style-type: none"> <li>In order to prevent blowing out cold air, indoor unit will be started after delaying for several minutes, which is a normal phenomenon.</li> </ul>

## Malfunction analysis

Phenomenon	Check items	Solution
Air conditioner can't operate	• Power failure?	• Wait until power recovery.
	• Is plug loose?	• Reinsert the plug.
	• Circuit break trips off or fuse is burnt out?	• Ask professional to replace circuit break or fuse.
	• Wiring has malfunction?	• Ask professional to replace it.
	• Unit has restarted immediately after stopping operation?	• Wait for 3min, and then turn on the unit again.
	• Whether the function setting for remote controller is correct?	• Reset the function.
Mist is emitted from indoor unit's air outlet	• Indoor temperature and humidity is high?	• Because indoor air is cooled rapidly. After a while, indoor temperature and humidity will be decrease and mist will disappear.
Set temperature can't be adjusted	• Unit is operating under auto mode?	• Temperature can't be adjusted under auto mode. Please switch the operation mode if you need to adjust temperature.
	• Your required temperature exceeds the set temperature range?	• Set temperature range: 16°C ~30°C .
Cooling (heating) effect is not good.	• Voltage is too low?	• Wait until the voltage resumes normal.
	• Filter is dirty?	• Clean the filter.
	• Set temperature is in proper range?	• Adjust temperature to proper range.
	• Door and window are open?	• Close door and window.

## Malfunction analysis

Phenomenon	Check items	Solution
Odours are emitted	<ul style="list-style-type: none"> <li>• Whether there's odour source, such as furniture and cigarette, etc.</li> </ul>	<ul style="list-style-type: none"> <li>• Eliminate the odour source.</li> <li>• Clean the filter.</li> </ul>
Air conditioner operates abnormally	<ul style="list-style-type: none"> <li>• Whether there's interference, such as thunder, wireless devices, etc.</li> </ul>	<ul style="list-style-type: none"> <li>• Disconnect power, put back power, and then turn on the unit again.</li> </ul>
"Water flowing" noise	<ul style="list-style-type: none"> <li>• Air conditioner is turned on or turned off just now?</li> </ul>	<ul style="list-style-type: none"> <li>• The noise is the sound of refrigerant flowing inside the unit, which is a normal phenomenon.</li> </ul>
Cracking noise	<ul style="list-style-type: none"> <li>• Air conditioner is turned on or turned off just now?</li> </ul>	<ul style="list-style-type: none"> <li>• This is the sound of friction caused by expansion and/or contraction of panel or other parts due to the change of temperature.</li> </ul>

## Malfunction analysis

### Error Code

- When air conditioner status is abnormal, temperature indicator on indoor unit will blink to display corresponding error code. Please refer to below list for identification of error code.



Above indicator diagram is only for reference. Please refer to actual product for the actual indicator and position.

Error code	Troubleshooting
Heating indicator ON 10s OFF 0.5s	Means defrosting status. It's the normal phenomenon.
E5	It can be eliminated after restarting the unit. If not, please contact qualified professionals for service.
U8	It can be eliminated after restarting the unit. If not, please contact qualified professionals for service.
H6	It can be eliminated after restarting the unit. If not, please contact qualified professionals for service.
C5	Please contact qualified professionals for service.
F1	Please contact qualified professionals for service.
F2	Please contact qualified professionals for service.

Note: If there're other error codes, please contact qualified professionals for service.

### WARNING

- When below phenomenon occurs, please turn off air conditioner and disconnect power immediately, and then contact the dealer or qualified professionals for service.
  - Power cord is overheating or damaged.
  - There's abnormal sound during operation.
  - Circuit break trips off frequently.
  - Air conditioner gives off burning smell.
  - Indoor unit is leaking.
- Do not repair or refit the air conditioner by yourself.
- If the air conditioner operates under abnormal conditions, it may cause malfunction, electric shock or fire hazard.

## Installation dimension diagram

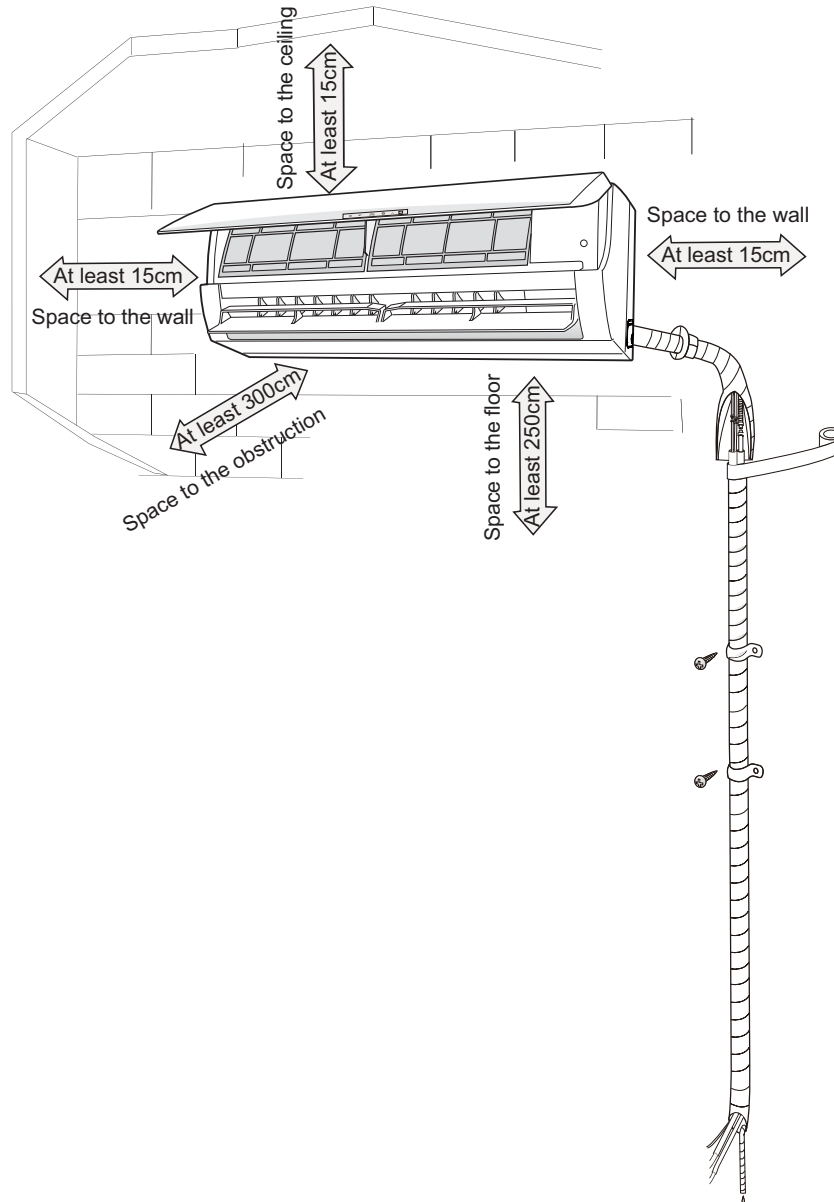

## Tools for installation

1 Level meter	2 Screw driver	3 Impact drill
4 Drill head	5 Pipe expander	6 Torque wrench
7 Open-end wrench	8 Pipe cutter	9 Leakage detector
10 Vacuum pump	11 Pressure meter	12 Universal meter
13 Inner hexagon spanner		14 Measuring tape

### Note:

- Please contact the local agent for installation.
- Don't use unqualified power cord.

## Selection of installation location

Basic requirement	Indoor unit
<p>Installing the unit in the following places may cause malfunction. If it is unavoidable, please consult the local dealer:</p> <ol style="list-style-type: none"> <li>1. The place with strong heat sources, vapors, flammable or explosive gas, or volatile objects spread in the air.</li> <li>2. The place with high-frequency devices (such as welding machine, medical equipment).</li> <li>3. The place near coast area.</li> <li>4. The place with oil or fumes in the air.</li> <li>5. The place with sulfureted gas.</li> <li>6. Other places with special circumstances.</li> <li>7. The appliance shall not be installed in the laundry</li> </ol>	<ol style="list-style-type: none"> <li>1. There should be no obstruction near air inlet and air outlet.</li> <li>2. Select a location where the condensation water can be dispersed easily and won't affect other people.</li> <li>3. Select a location which is convenient to connect the outdoor unit and near the power socket.</li> <li>4. Select a location which is out of reach for children.</li> <li>5. The location should be able to withstand the weight of indoor unit and won't increase noise and vibration.</li> <li>6. The appliance must be installed 2.5m above floor.</li> <li>7. Don't install the indoor unit right above the electric appliance.</li> <li>8. Please try your best to keep way from fluorescent lamp.</li> </ol>

## Requirements for electric connection

### Safety precaution

1. Must follow the electric safety regulations when installing the unit.
2. According to the local safety regulations, use qualified power supply circuit and circuit break.
3. Make sure the power supply matches with the requirement of air conditioner. Unstable power supply or incorrect wiring or malfunction. Please install proper power supply cables before using the air conditioner.
4. Properly connect the live wire, neutral wire and grounding wire of power socket.
5. Be sure to cut off the power supply before proceeding any work related to electricity and safety.
6. Do not put through the power before finishing installation.
7. If the supply cord is damaged, it must be replaced by the manufacturer, its service agent or similarly qualified persons in order to avoid a hazard.
8. The temperature of refrigerant circuit will be high, please keep the interconnection cable away from the copper tube.
9. The appliance shall be installed in accordance with national wiring regulations.
10. Installation must be performed in accordance with the requirement of NEC and CEC by authorized personnel only.

### Grounding requirement

1. The air conditioner is the first class electric appliance. It must be properly grounding with specialized grounding device by a professional. Please make sure it is always grounded effectively, otherwise it may cause electric shock.
2. The yellow-green wire in air conditioner is grounding wire, which can't be used for other purposes.
3. The grounding resistance should comply with national electric safety regulations.
4. The appliance must be positioned so that the plug is accessible.
5. An all-pole disconnection switch having a contact separation of at least 3mm in all poles should be connected in fixed wiring.
6. Including an circuit break with suitable capacity, please note the following table. Circuit break should be included magnet buckle and heating buckle function, it can protect the circuit-short and overload. (Caution: please do not use the fuse only for protect the circuit)

Air-conditioner	Air switch capacity
18K	20A
24K	25A

## Installation of indoor unit

### Step one: choosing installation location

Recommend the installation location to the client and then confirm it with the client.

### Step two: install wall-mounting frame

1. Hang the wall-mounting frame on the wall; adjust it in horizontal position with the level meter and then point out the screw fixing holes on the wall.
2. Drill the screw fixing holes on the wall with impact drill (the specification of drill head should be the same as the plastic expansion particle) and then fill the plastic expansion particles in the holes.
3. Fix the wall-mounting frame on the wall with tapping screws (ST4.2X25TA) and then check if the frame is firmly installed by pulling the frame. If the plastic expansion particle is loose, please drill another fixing hole nearby.

### Step three: open piping hole

1. Choose the position of piping hole according to the direction of outlet pipe. The position of piping hole should be a little lower than the wall-mounted frame, shown as below.

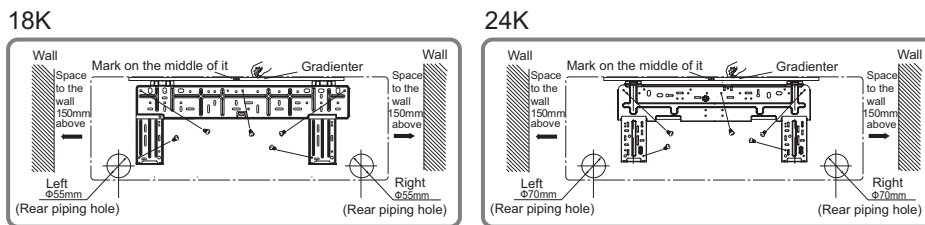

2. Open a piping hole with the diameter of  $\Phi 55$  or  $\Phi 70$  on the selected outlet pipe position. In order to drain smoothly, slant the piping hole on the wall slightly downward to the outdoor side with the gradient of 5-10°.

## Installation of indoor unit

### Note:

- Pay attention to dust prevention and take relevant safety measures when opening the hole.
- The plastic expansion particles are not provided and should be bought locally.

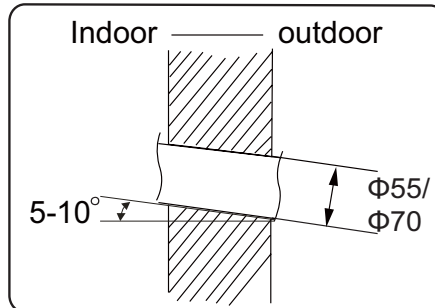

### Step four: outlet pipe

1. The pipe can be led out in the direction of right, rear right, left or rear left.

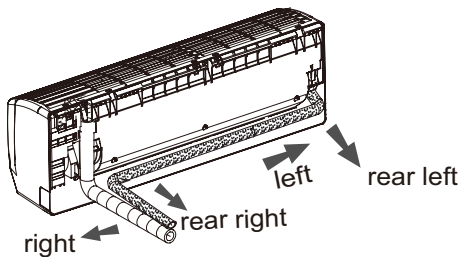

2. When select leading out the pipe from left or right, please cut off the corresponding hole on the bottom case.

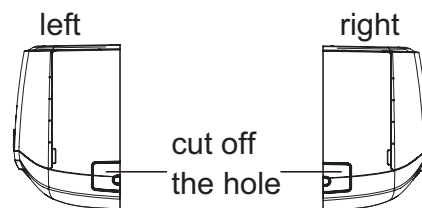

### Step five: connect the pipe of indoor unit

1. Aim the pipe joint at the corresponding bellmouth.
2. Pretightening the union nut with hand.

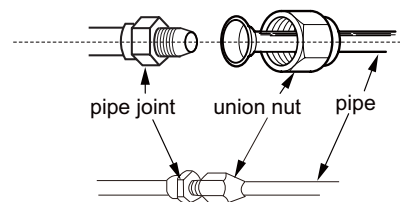

3. Adjust the torque force by referring to the following sheet. Place the open-end wrench on the pipe joint and place the torque wrench on the union nut. Tighten the union nut with torque wrench.

## Installation of indoor unit

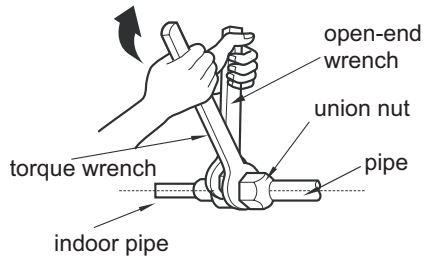

Hex nut diameter	Tightening torque (N·m)
Φ 6	15~20
Φ 9.52	30~40
Φ 12	45~55
Φ 16	60~65
Φ 19	70~75

4. Wrap the indoor pipe and joint of connection pipe with insulating pipe, and then wrap it with tape.

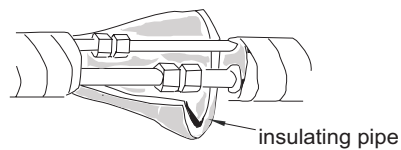

### Step six: install drain hose

1. Connect the drain hose to the outlet pipe of indoor unit.
2. Bind the joint with tape.

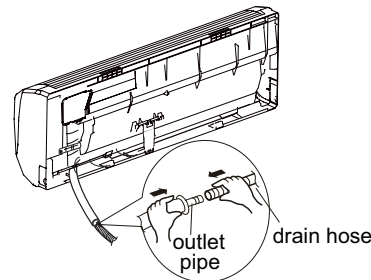
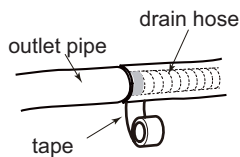

#### Note:

- Add insulating pipe in the indoor drain hose in order to prevent condensation.
- The plastic expansion particles are not provided.

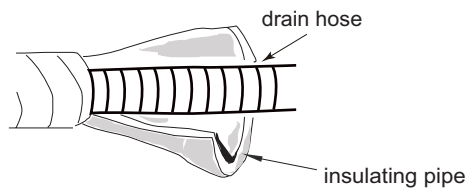

### Step seven: connect wire of indoor unit

1. Open the panel, remove the screw on the wiring cover and then take down the cover.

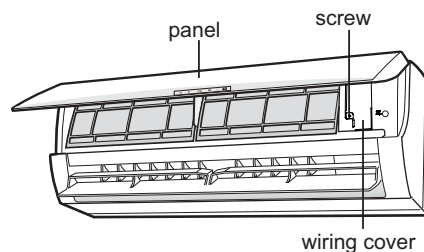

## Installation of indoor unit

2. Make the power connection wire go through the cable-cross hole at the back of indoor unit and then pull it out from the front side.

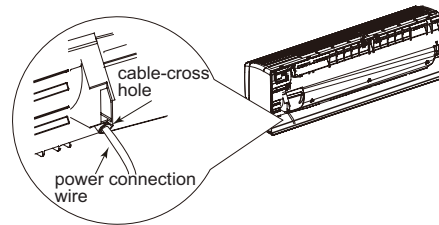

3. Remove the wire clip; connect the power connection wire to the wiring terminal according to the color; tighten the screw and then fix the power connection wire with wire clip.

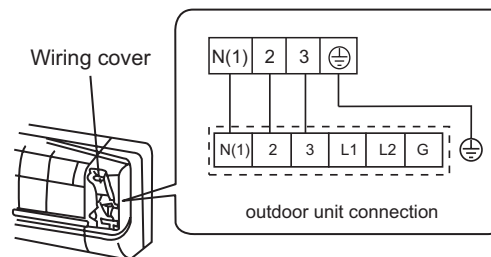

4. Put wiring cover back and then tighten the screw.
5. Close the panel.

Note:

- All wires of indoor unit and outdoor unit should be connected by a professional.
- If the length of power connection wire is insufficient, please contact the supplier for a new one. Avoid extending the wire by yourself.
- For the air conditioner with plug, the plug should be reachable after finishing installation.
- For the air conditioner without plug, an circuit breaker must be installed in the line. The air switch should be all-pole parting and the contact parting distance should be more than 3mm.

## Installation of indoor unit

### Step eight: bind up pipe

1. Bind up the connection pipe, power cord and drain hose with the band.

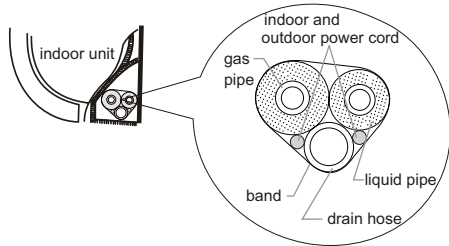

2. Reserve a certain length of drain hose and power cord for installation when binding them. When binding to a certain degree, separate the indoor power and then separate the drain hose.

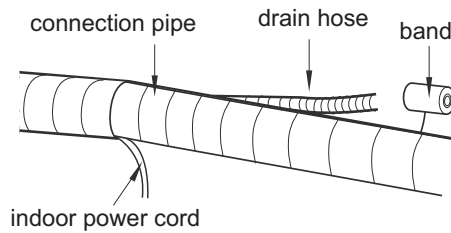

3. Bind them evenly.
4. The liquid pipe and gas pipe should be bound separately at the end.

**Note:**

- The power cord and control wire can't be crossed or winding.
- The drain hose should be bound at the bottom.

### Step nine: hang the indoor unit

1. Put the bound pipes in the wall pipe and then make them pass through the wall hole.
2. Hang the indoor unit on the wall-mounting frame.
3. Stuff the gap between pipes and wall hole with sealing gum.
4. Fix the wall pipe.
5. Check if the indoor unit is installed firmly and closed to the wall.

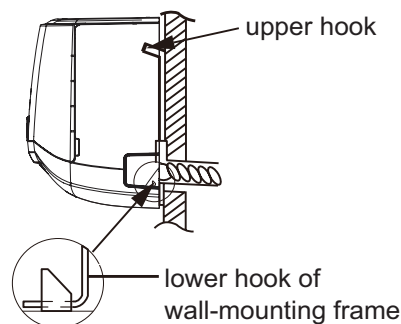
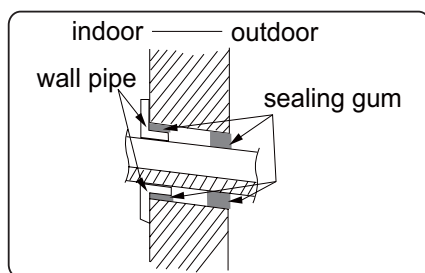

**Note:**

- Do not bend the drain hose too excessively in order to prevent blocking.

## Check after installation

- Check according to the following requirement after finishing installation.

Items to be checked	Possible malfunction
Has the unit been installed firmly?	The unit may drop, shake or emit noise.
Have you done the refrigerant leakage test?	It may cause insufficient cooling (heating) capacity.
Is heat insulation of pipeline sufficient?	It may cause condensation and water dripping.
Is water drained well?	It may cause condensation and water dripping.
Is the voltage of power supply according to the voltage marked on the nameplate?	It may cause malfunction or damaging the parts.
Is electric wiring and pipeline installed correctly?	It may cause malfunction or damaging the parts.
Is the unit grounded securely?	It may cause electric leakage.
Does the power cord follow the specification?	It may cause malfunction or damaging the parts.
Is there any obstruction in the air inlet and outlet?	It may cause insufficient cooling (heating) capacity.
The dust and sundries caused during installation are removed?	It may cause malfunction or damaging the parts.
The gas valve and liquid valve of connection pipe are open completely?	It may cause insufficient cooling (heating) capacity.

## Test operation

### 1. Preparation of test operation

- The client approves the air conditioner.
- Specify the important notes for air conditioner to the client.

### 2. Method of test operation

- Put through the power, press ON/OFF button on the remote controller to start operation.
- Press MODE button to select AUTO, COOL, DRY, FAN and HEAT to check whether the operation is normal or not.
- If the ambient temperature is lower than 16°C , the air conditioner can't start cooling.

## Configuration of connection pipe

1. Standard length of connection pipe
  - 5m, 7.5m, 8m.
2. Min. length of connection pipe is 3m.
3. Max. length of connection pipe and max. high difference.

Cooling capacity	Max length of connection pipe	Max height difference	Cooling capacity	Max length of connection pipe	Max height difference
5000Btu/h (1465W)	15	5	24000Btu/h (7032W)	25	10
7000Btu/h (2051W)	15	5	28000Btu/h (8204W)	30	10
9000Btu/h (2637W)	15	5	36000Btu/h (10548W)	30	20
12000Btu/h (3516W)	20	10	42000Btu/h (12306W)	30	20
18000Btu/h (5274W)	25	10	48000Btu/h (14064W)	30	20

4. The additional refrigerant oil and refrigerant charging required after prolonging connection pipe
  - After the length of connection pipe is prolonged for 10m at the basis of standard length, you should add 5ml of refrigerant oil for each additional 5m of connection pipe.
  - The calculation method of additional refrigerant charging amount (on the basis of liquid pipe):
    - Additional refrigerant charging amount = prolonged length of liquid pipe × additional refrigerant charging amount per meter
  - Basing on the length of standard pipe, add refrigerant according to the requirement as shown in the table. The additional refrigerant charging amount per meter is different according to the diameter of liquid pipe. See the following sheet.

## Configuration of connection pipe

Additional refrigerant charging amount for R22, R407C, R410A and R134a

Diameter of connection pipe		Outdoor unit throttle	
Liquid pipe(mm)	Gas pipe(mm)	Cooling only(g/m)	Cooling and heating(g/m)
Φ6	Φ9.52 or Φ12	15	20
Φ6 or Φ9.52	Φ16 or Φ19	15	50
Φ12	Φ19 or Φ22.2	30	120
Φ16	Φ25.4 or Φ31.8	60	120
Φ19	—	250	250
Φ22.2	—	350	350

## Pipe expanding method

### Note:

Improper pipe expanding is the main cause of refrigerant leakage. Please expand the pipe according to the following steps:

#### A: Cut the pipe

- Confirm the pipe length according to the distance of indoor unit and outdoor unit.
- Cut the required pipe with pipe cutter.

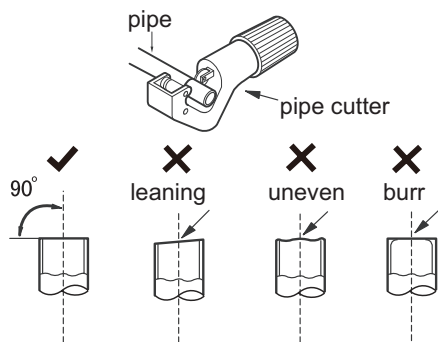

#### B: Remove the burrs

- Remove the burrs with shaper and prevent the burrs from getting into the pipe.

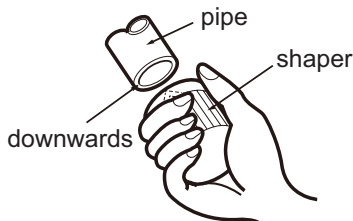

#### C: Put on suitable insulating pipe

#### D: Put on the union nut

- Remove the union nut on the indoor connection pipe and outdoor valve; install the union nut on the pipe.

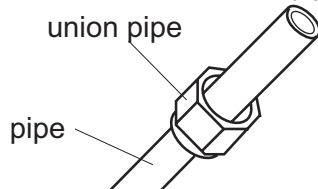

#### E: Expand the port

- Expand the port with expander.

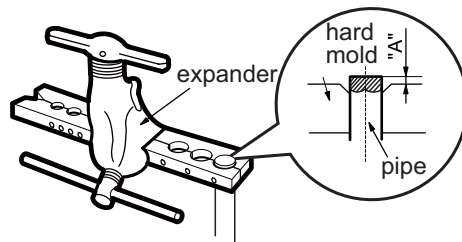

#### Note:

- "A" is different according to the diameter, please refer to the sheet below:

Outer diameter (mm)	A(mm)	
	Max	Min
Φ6 - 6.35(1/4")	1.3	0.7
Φ9.52(3/8")	1.6	1.0
Φ12-12.7(1/2")	1.8	1.0
Φ15.8-16(5/8")	2.4	2.2

#### F: Inspection

- Check the quality of expanding port. If there is any blemish, expand the port again according to the steps above.

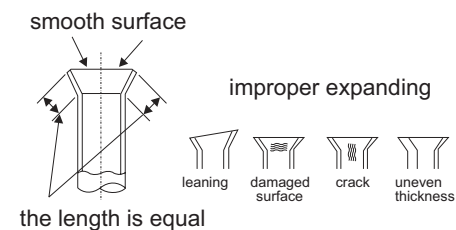

## Wired Controller

If the product you bought is equipped with wired controller, please refer to the following introductions of wired controller.

### 1 Displaying Part

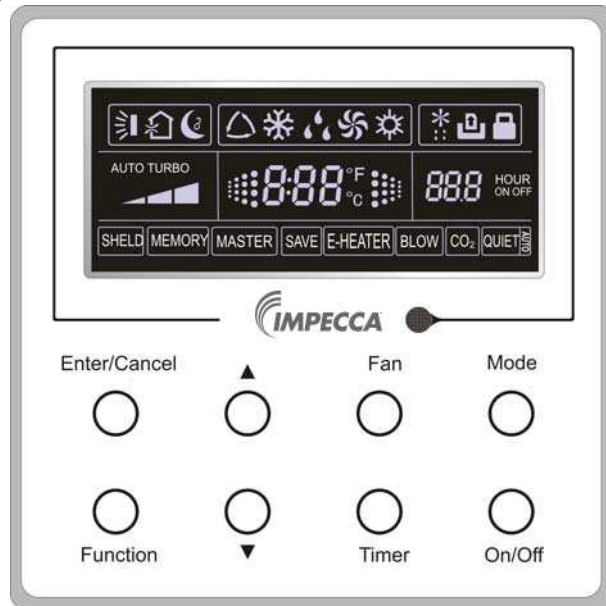

Fig1.1.1 Outline of wired controller

### 1.1 LCD Display of Wired Controller

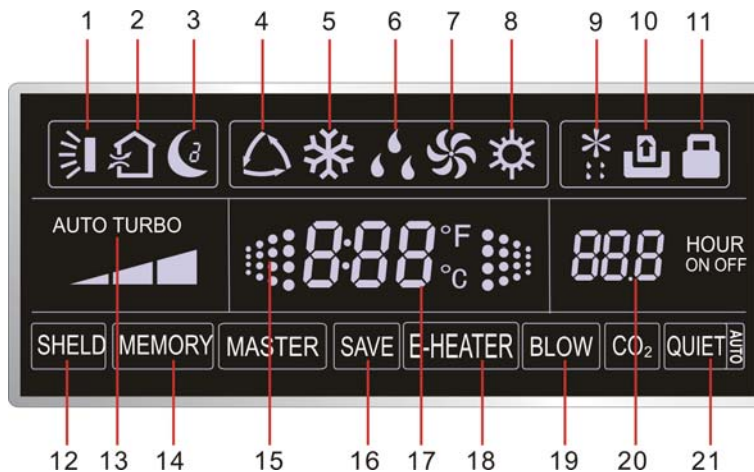















Fig.1.1.2 LCD display

# Wired Controller

## 1.2 Instruction to LCD Display

Table 1.1

No.	Symbols	Description
1		Swing function
2		Air exchange function (this function is yet unavailable for this unit).
3		Sleep function (Only sleep 1).
4		Each kind of running mode of indoor unit (auto mode)
5		Cooling mode
6		Dry mode
7		Fan mode
8		Heating mode
9		Defrosting function for the outdoor unit.
10		Gate-control function (this function is yet unavailable for this unit).
11		Lock function.
12	SHIELD	Shield functions (Button operation, temperature setting, On/Off operation, Mode setting are disabled by the remote monitoring system.)
13	Turbo	Turbo function state
14	MEMORY	Memory function (The indoor unit resumes the original setting state after power failure and then power recovery).
15		It blinks under on state of the unit without operation of any button.
16	SAVE	Energy-saving function (this function is yet unavailable for this unit).
17		Ambient/setting temperature value
18	E-HEATER	Electric auxiliary heating function.
19	BLOW	Blow function.
20		Timing value.
21	QUIET	Quiet function (two types: quiet and auto quiet) (this function is yet unavailable for this unit).

# Wired Controller

## 2 Buttons

### 2.1 Layout of Buttons

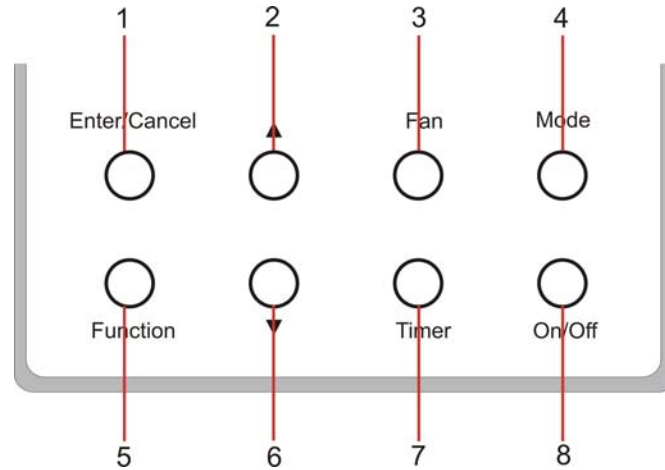

### 2.2 Functions of Buttons

Table 2.1

No.	Name	Function
1	Enter/Cancel	Function selection and cancellation.
2	▲	① . Running temperature setting of the indoor unit, range:16~30°C. ② . Timer setting, range:0.5-24 hr.
6	▼	
3	Fan	Setting of the high/middle/low/auto fan speed.
4	Mode	Setting of the Cooling/Heating/Fan/Dry/Auto mode of the indoor unit.
5	Function	Switchover among the functions of Turbo/Save/E-heater/Blow etc..
7	Timer	Timer setting.
8	On/Off	Turn on/off the indoor unit
4+2	▲+Mode	Press them for 5s under off state of the unit to enter/cancel the Memory function(If memory is set, indoor unit after power failure and then power recovery will resume the original setting state. If not, the indoor unit is defaulted to be off after power recovery. Memory off is default before delivery.).
3+6	Fan+▼	By pressing them at the same time under off state of the unit, ❄️ will be displayed on the wired controller for the cooling only unit, while 🌞 will be displayed on the wired controller for the cooling and heating unit.
2+6	▲+▼	Upon startup of the unit without malfunction or under off state of the unit,press them at the same time for 5s to enter the lock state, in which case,any other buttons won't respond the press. Repress them for 5s to quit this state.

# Wired Controller

## 3 Operation Instructions

### 3.1 On/Off

Press On/Off to turn on the unit and turn it off by another press.

Note: The state shown in Fig.3.1.1 indicates the "Off" state of the unit after power on. The state shown in Fig.3.1.2 indicates the "On" state of the unit after power on.

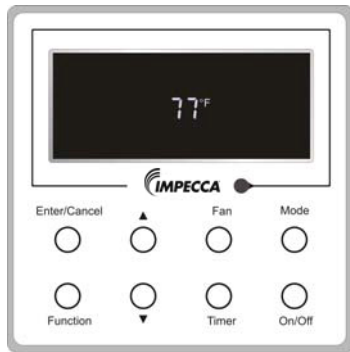

Fig.3.1.1 "Off" State

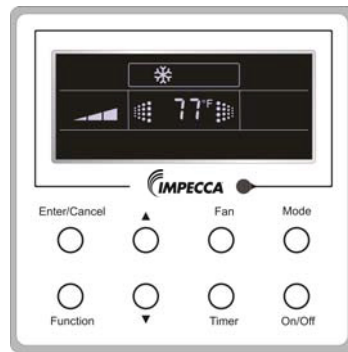
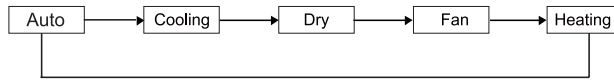

Fig.3.1.2 "On" State

### 3.2 Mode Setting

Under ON state of the unit, press the Mode to switch the operation modes as the following sequence: Auto–Cooling–Dry–Fan–Heating.



### 3.3 Temperature Setting

Press ▲ or ▼ to increase/decrease the preset temperature. If pressing either of them continuously, the temperature will be increased or decreased by 1°C every 0.5s, as shown in Fig.3.3.1.

In the Cooling, Dry, Fan or Heating mode, the temperature setting range is 16°C~30°C.

In the Auto mode, the setting temperature is unadjustable.

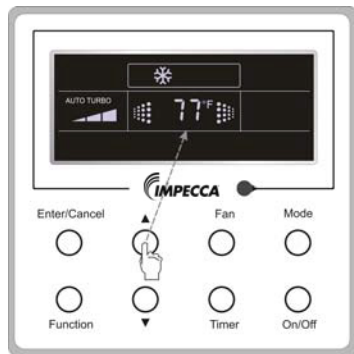

Fig.3.3.1

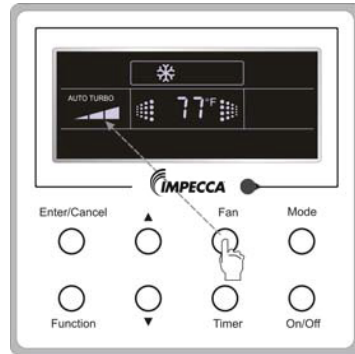
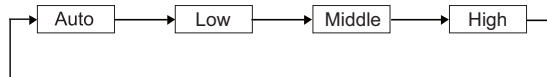

Fig.3.4.1

# Wired Controller

## 3.4 Fan Setting

Under the "On" state of the unit, press Fan and then fan speed of the indoor unit will change circularly as shown in Fig.3.4.1.



## 3.5 Timer Setting

Under on-state of the unit, Press Timer button to set timer off of the unit. Under off-state of the unit, press Timer button to set timer on of the unit in the same way.

- Timer on setting:

Under off-state of the unit without timer setting, if Timer button is pressed, LCD will display xx. Hour, with ON blinking. In this case, press ▲ or ▼ button to adjust timer on and then press Timer to confirm.

- Timer off setting:

Under on-state of the unit without timer setting, if Timer button is pressed, LCD will display xx. Hour, with OFF blinking. In this case, press ▲ or ▼ button to adjust timer on and then press Timer to confirm.

- Cancel timer:

After setting of timer, if Timer button is pressed, LCD won't display xx. Hour so that timer setting is canceled.

Timer off setting under the "On" state of the unit is shown as Fig.3.5.1.

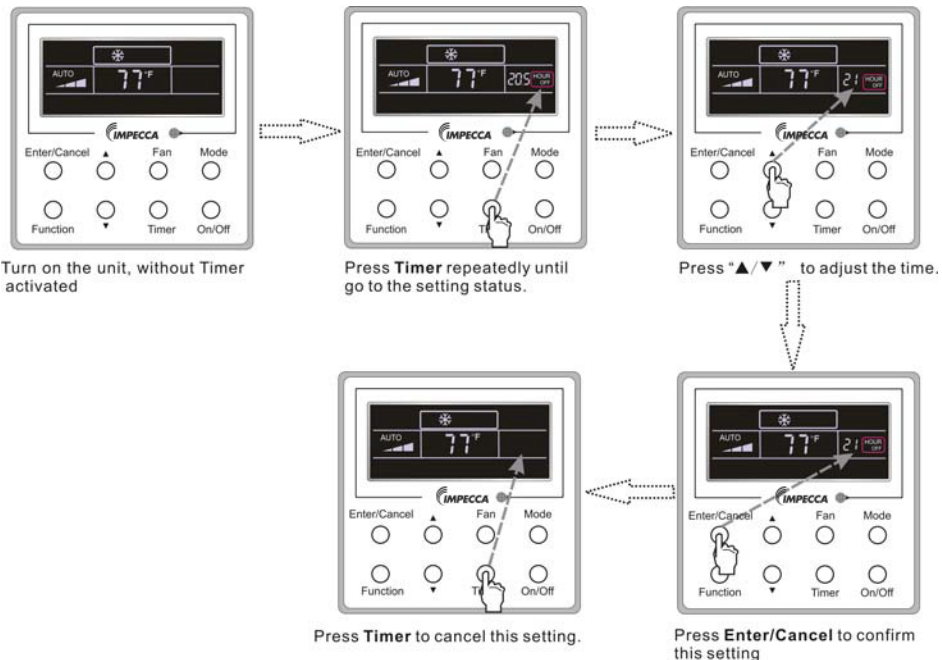

Fig.3.5.1 Timer off Setting under the "On" State of the Unit



## Wired Controller

Timer on setting under the “Off” state of the unit is shown as Fig.3.5.2.

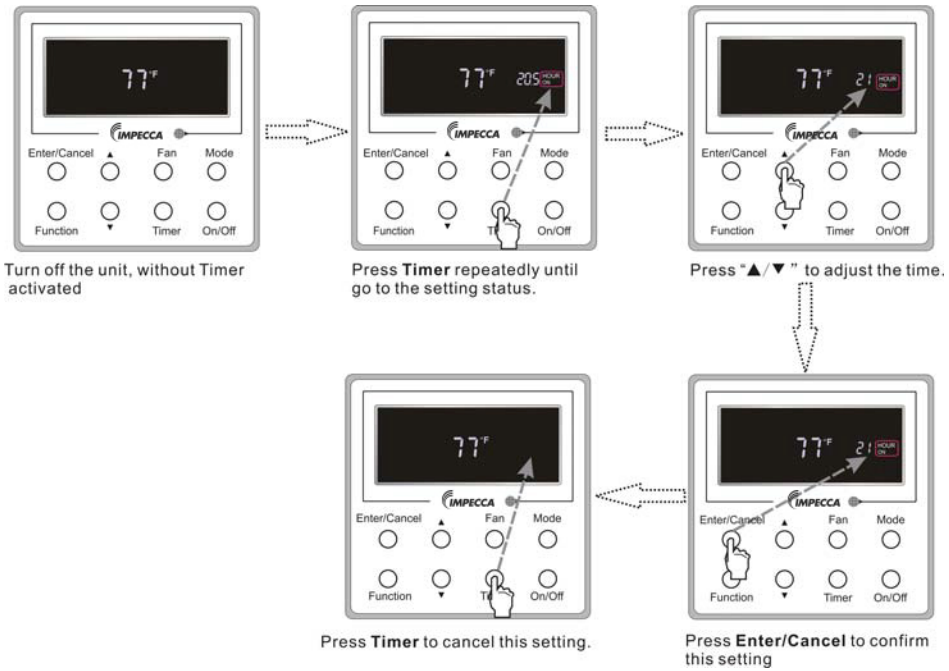



Fig.3.5.2 Timer on Setting under the “Off” State of the Unit

Timer range: 0.5-24hr. Every press of **▲** or **▼** will make the set time increased or decreased by 0.5hr. If either of them is pressed continuously, the set time will increase/ decrease by 0.5hr every 0.5s.

# Wired Controller

## 3.6 Swing Setting

**Swing On:** Press **Function** under on state of the unit to activate the swing function. In this case,  will blink. After that, press **Enter/Cancel** to make a confirmation.

**Swing Off:** When the Swing function is on, press **Function** to enter the Swing setting interface, with  blinking. After that, press **Enter/Cancel** to cancel this function. Swing setting is shown as Fig.3.6.1.

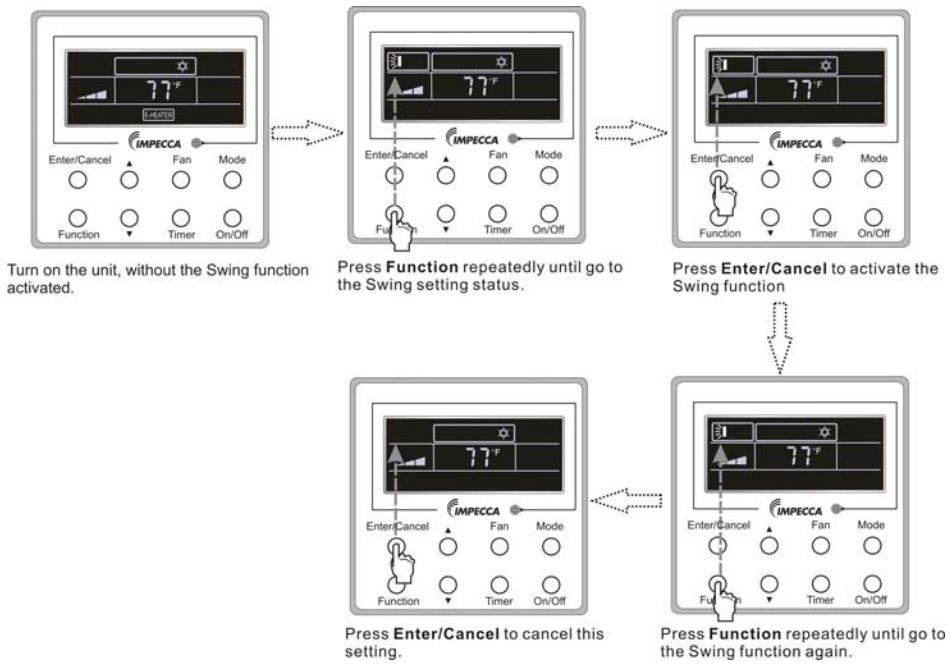

Fig.3.6.1 Swing Setting

Notes:

- ① . Sleep, Turbo or Blow setting is the same as the Swing setting.
- ② . After the setting has been done, it has to press the key "Enter/Cancel" to back to the setting status or quit automatically five seconds later.

## Wired Controller

### 3.7 Sleep Setting

**Sleep on:** Press Function under the On state of the unit till the unit enters the Sleep setting state. After that, press Enter/Cancel to confirm this setting.

**Sleep off:** When the Sleep function is activated, press Function to enter the Sleep setting status. After that, press Enter/Cancel to cancel this function.

In the Cooling or Dry mode, the temperature will increase by 1°C after the unit runs under Sleep1 for 1hr and 1°C after another 1hr. After that, the unit will run at this temperature.

In the Heating mode, the temperature will decrease by 1°C after the unit runs under Sleep 1 for 1hr and 1°C after another 1hr. After that, the unit will run at this temperature.

Sleep setting is shown as Fig.3.7.1.

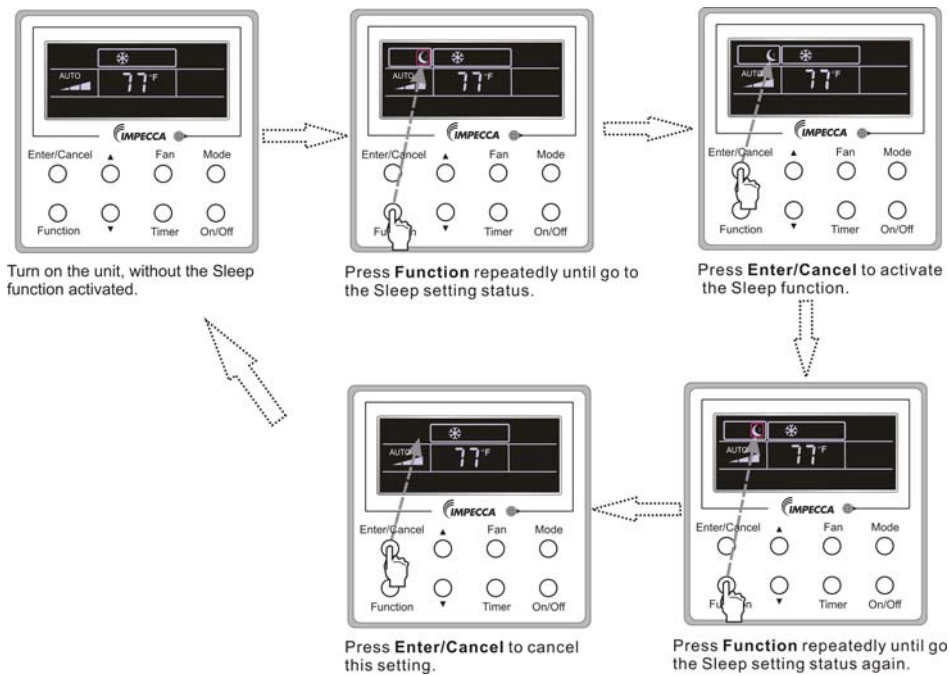

Fig.3.7.1. Sleep Setting

## Wired Controller

### 3.8 Turbo Setting

Turbo function: The unit at the high fan speed can realize quick cooling or heating so that the room temperature can quickly approach the setting value.

In the Cooling or Heating mode, press **Function** till the unit enters the Turbo setting status and then press **Enter/Cancel** to confirm the setting.

When the Turbo function is activated, press **Function** to enter the Turbo setting status and then press **Enter/Cancel** to cancel this function.

Turbo function setting is as shown in Fig.3.8.1.

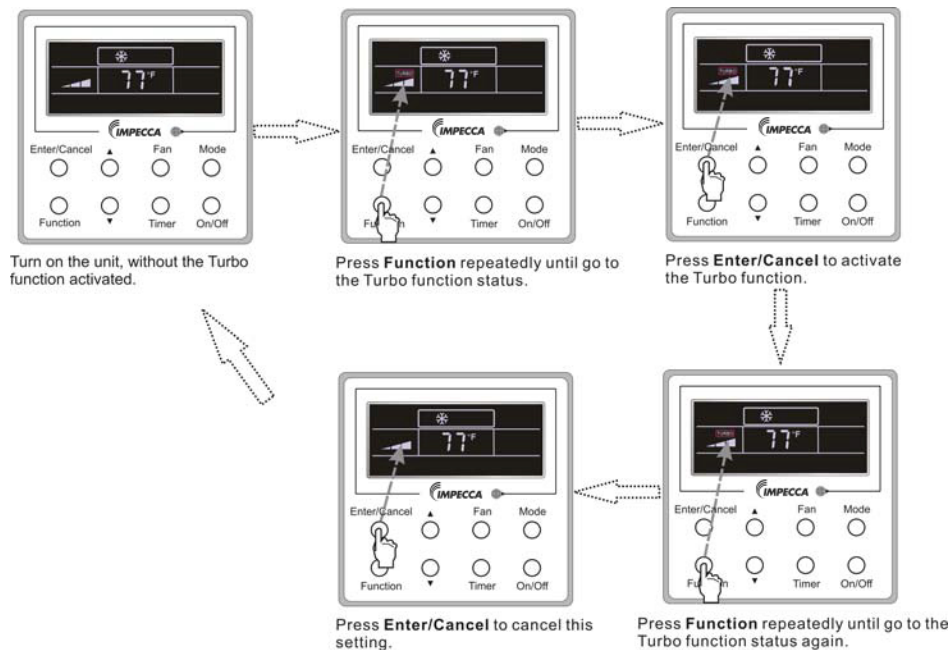

Fig.3.8.1 Turbo Setting

# Wired Controller

## 3.9 E-heater Setting

E-heater (auxiliary electric heating function): In the Heating mode, E-heater is allowed to be turned on for improvement of efficiency.

Once the wired controller or the remote controller enters the Heating mode, this function will be turned on automatically.

Press **Function** in the Heating mode to enter the E-heater setting interface and then press **Enter/Cancel** to cancel this function.

Press **Function** to enter the E-heater setting status, if the E-heater function is not activated, and then press **Enter/Cancel** to activate it.

The setting of this function is shown as Fig.3.9.1 below:

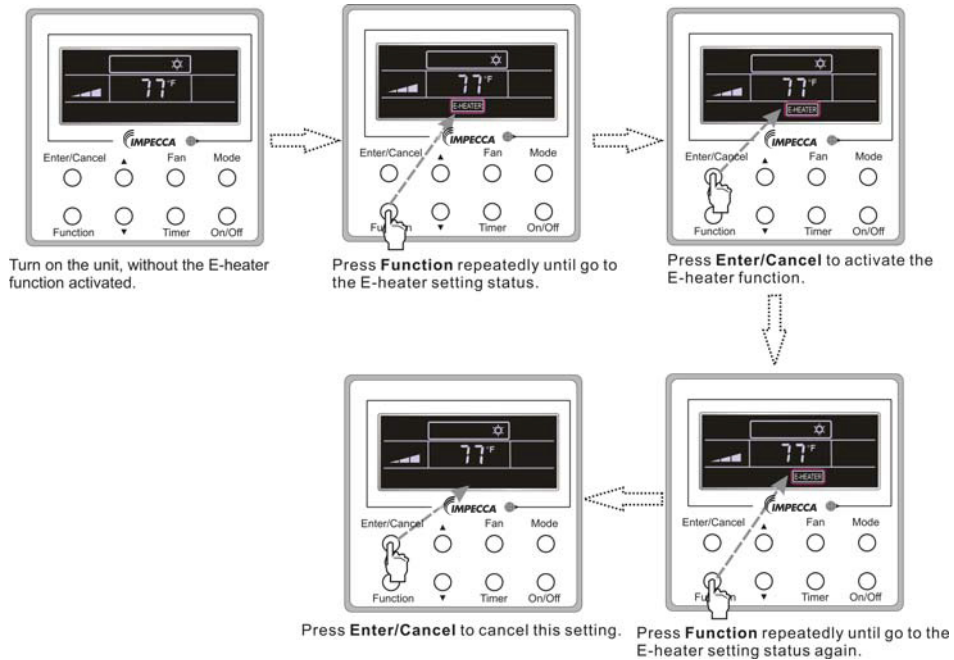

Fig.3.9.1 E-heater Setting

# Wired Controller

## 3.10 Blow Setting

Blow function: After the unit is turned off, the water in evaporator of indoor unit will be automatically evaporated to avoid mildew.

In the Cooling or Dry mode, press **Function** till the unit enters the Blow setting status and then press **Enter/Cancel** to activate this function.

When the Blow function is activated, press **Function** to the Blow setting status and then press **Enter/Cancel** to cancel this function.

Blow function setting is as shown in Fig.3.10.1

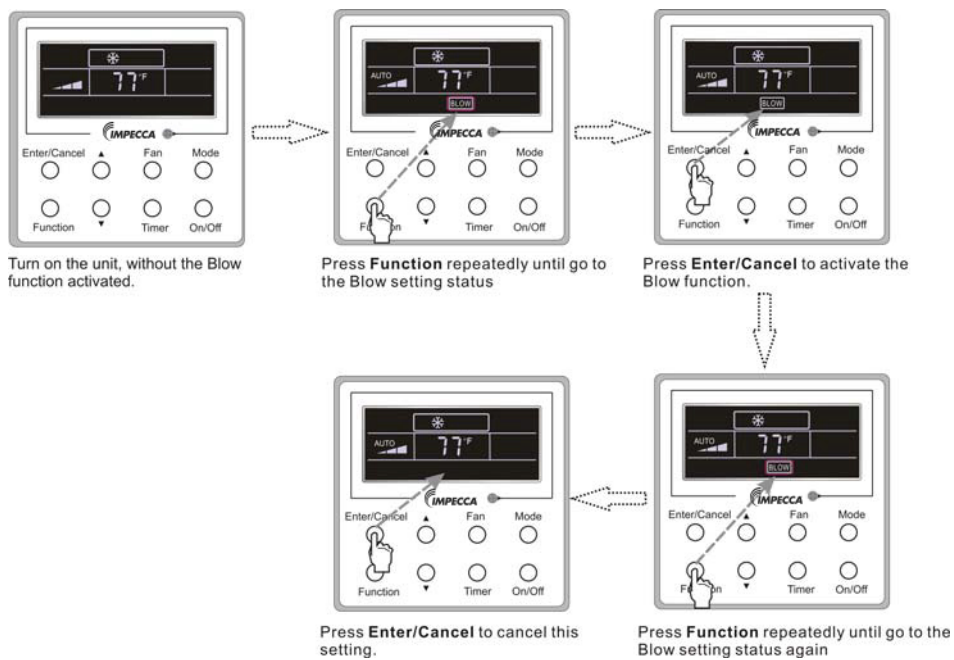

Fig.3.10.1 Blow Setting

Notes:

① . When the Blow function is activated, if turning off the unit by pressing On/Off or by the remote controller, the indoor fan will run at the low fan speed for 2 min, with "BLOW" displayed on the LCD. While, if the Blow function is deactivated, the indoor fan will be turned off directly.

② . Blow function is unavailable in the Fan or Heating mode.

# Wired Controller

## 3.11 Other Functions

### a. Lock

Upon startup of the unit without malfunction or under the "Off" state of the unit, press ▲ and ▼ at the same time for 5s till the wired controller enters the Lock function. In this case, LCD displays .

After that, repress these two buttons at the same time for 5s to quit this function.

Under the Lock state, any other button press won't get any response.

### b. Memory

Memory switchover: Under the "Off" state of the unit, press Mode and ▲ at the same time for 5s to switch memory states between memory on and memory off. When this function is activated, Memory will be displayed. If this function is not set, the unit will be under the "Off" state after power failure and then power recovery.

Memory recovery: If this function has been set for the wired controller, the wired controller after power failure will resume its original running state upon power recovery. Memory contents: On/Off, Mode, set temperature, set fan speed and Lock function.

## 4 Installation and Dismantlement

### 4.1 Connection of the Signal Line of the Wired Controller

- Open the cover of the electric control box of the indoor unit.
- Let the single line of the wired controller through the rubber ring.
- Connect the signal line of the wired control to the 4-pin socket of the indoor unit PCB.
- Tighten the signal wire with ties.
- The communication distance between the main board and the wired controller can be up to 20 meters ( the standard distance is 8 meters)

### 4.2 Installation of the Wired Controller

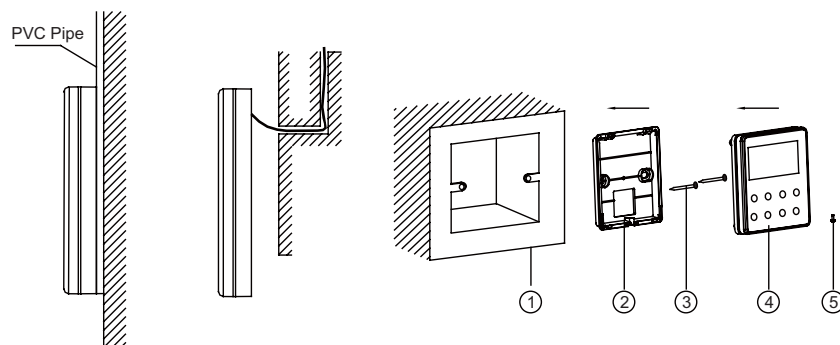

Fig.4.1 Accessories for the Installation of the Wired Controller

Table 4.1

No.	1	2	3	4	5
Name	Socket box embedded in the wall	Soleplate of the Wired Controller	Screw M4X25	Front Panel of the Wired Controller	Screw ST 2.9X6

## Wired Controller

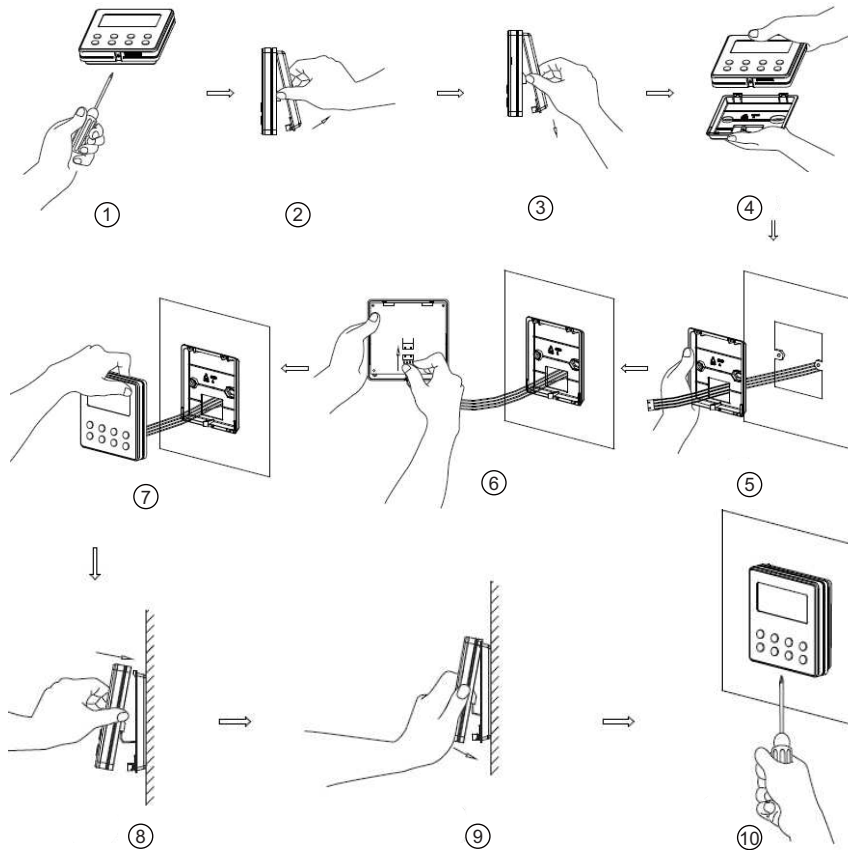

Fig.4.2

Fig.4.2 shows the installation steps of the wired controller, but there are some issues that need your attention.

1) Prior to the installation, please firstly cut off the power supply of the wire buried in the installation hole, that is, no operation is allowed with electricity during the whole installation.

2) Pull out the four-core twisted pair line from the installation holes and then let it go through the rectangular hole behind the soleplate of the wired controller.

3) Stick the soleplate of the wired controller to the wall over the installation hole and then fix it with screws M4X25.

4) Insert the four-core twisted pair line into the slot of the wired controller and then buckle the front panel and the soleplate of the wired controller together.

5) Finally, fix the front panel and the soleplate of the wired controller tightly by screws ST2.9X6.

### **⚠ CAUTION!**

Please pay special attention to the followings during the connection to avoid the malfunction of the air conditioning unit due to electromagnetic interference.

① . Separate the signal and communication lines of the wired controller from the power cord

## Wired Controller

and connection lines between the indoor and outdoor unit, with a minimum interval of 20cm, otherwise the communication of the unit will probably work abnormally.

②. If the air conditioning unit is installed where is vulnerable to electromagnetic interference, then the signal and communication lines of the wired controller must be the shielding twisted pair lines.

### 4.3 Dismantlement of the Wired Controller

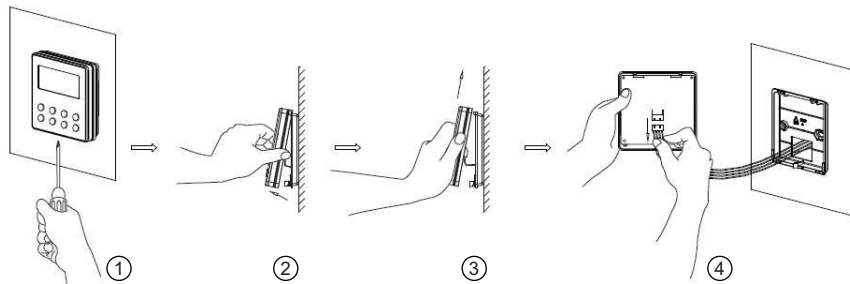

## 5 Errors Display

If there is an error occurring during the operation of the system, the error code will be displayed on the LCD, as show in Fig.5.1. If multi errors occur at the same time, their codes will be displayed circularly.

Note: In event of any error, please turn off the unit and contact the professionally skilled personnel.

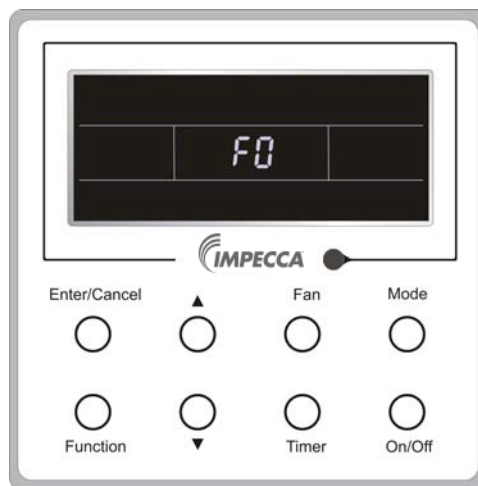

Fig.5.1

## Wired Controller

Table 5.1 Meaning of Each Error

Error	Error Code	Error	Error Code
Return air temperature sensor open/ short circuited	F1	Drive board communication error	P6
evaporator temperature sensor open/ short circuited	F2	Compressor overheating protection	H3
Indoor unit liquid valve temperature sensor open/short circuited	b5	Indoor and outdoor units unmatched	LP
Indoor gas valve temperature sensor open/ short circuited	b7	Communication line misconnected or expansion valve error	dn
IPM temperature sensor open/short circuited	P7	Running mode conflict	E7
Outdoor ambient temperature sensor open/ short circuited	F3	Pump-down	Fo
Outdoor unit condenser mid-tube temperature sensor open/short circuited	F4	Jumper error	C5
Discharge temperature sensor open/ short circuited	F5	Forced defrosting	H1
Indoor and outdoor communication error	E6	Compressor startup failure	Lc
DC bus under-voltage protection	PL	High discharge temperature protection	E4
DC bus over-voltage protection	PH	Overload protection	E8
Compressor phase current sensing circuit error	U1	Whole unit over-current protection	E5
Compressor demagnetization protection	HE	Over phase current protection	P5
PFC protection	Hc	Compressor desynchronizing	H7
IPM Temperature Protection	P8	IPM Current protection	H5
Over-power protection	L9	Compressor phase loss/reversal protection	Ld
System charge shortage or blockage protection	F0	Frequency restricted/reduced with whole unit current protection	F8
Capacitor charging error	PU	Frequency restricted/reduced with IPM current protection	En
High pressure protection	E1	Frequency restricted/reduced with high discharge temperature	F9
Low pressure protection	E3	Frequency restricted/reduced with anti-freezing protection	FH
Compressor stalling	LE	Frequency restricted/reduced with overload protection	F6
Over-speeding	LF	Frequency restricted/reduced with IPM temperature protection	EU
Drive board temperature sensor error	PF	Indoor unit full water error	E9
AC contactor protection	P9	Anti-freezing protection	E2
Temperature drift protection	PE	AC input voltage abnormal	PP
Sensor connection protection	Pd	Whole unit current sensing circuit error	U5
DC bus voltage drop error	U3	4-way valve reversing error	U7
Outdoor fan 1 error protection	L3	Motor stalling	H6
Outdoor fan 2 error protection	LA	PG motor zero-crossing protection	U8

# CUSTOMER SUPPORT

Before contacting customer support, please see the troubleshooting guide above.  
Visit our website to contact us, find answers to Frequently Asked Questions, and for other resources which may include an updated version of this user's guide.

 **WWW.IMPECCA.COM**

If you wish to contact us by phone, please be sure to have your model number and serial number ready and call us between 9:00am and 6:00pm ET, at +1 866-954-4440.

Keep tabs on Impecca's newest innovations & enter contests via our social network feeds:

 [www.facebook.com/Impecca/](http://www.facebook.com/Impecca/)

 [www.instagram.com/Impecca/](http://www.instagram.com/Impecca/)

 [@impeccausa](https://twitter.com/impeccausa)

