

INSTRUCTIONS FOR USE
OF AN UPRIGHT FRIDGE
FREEZER

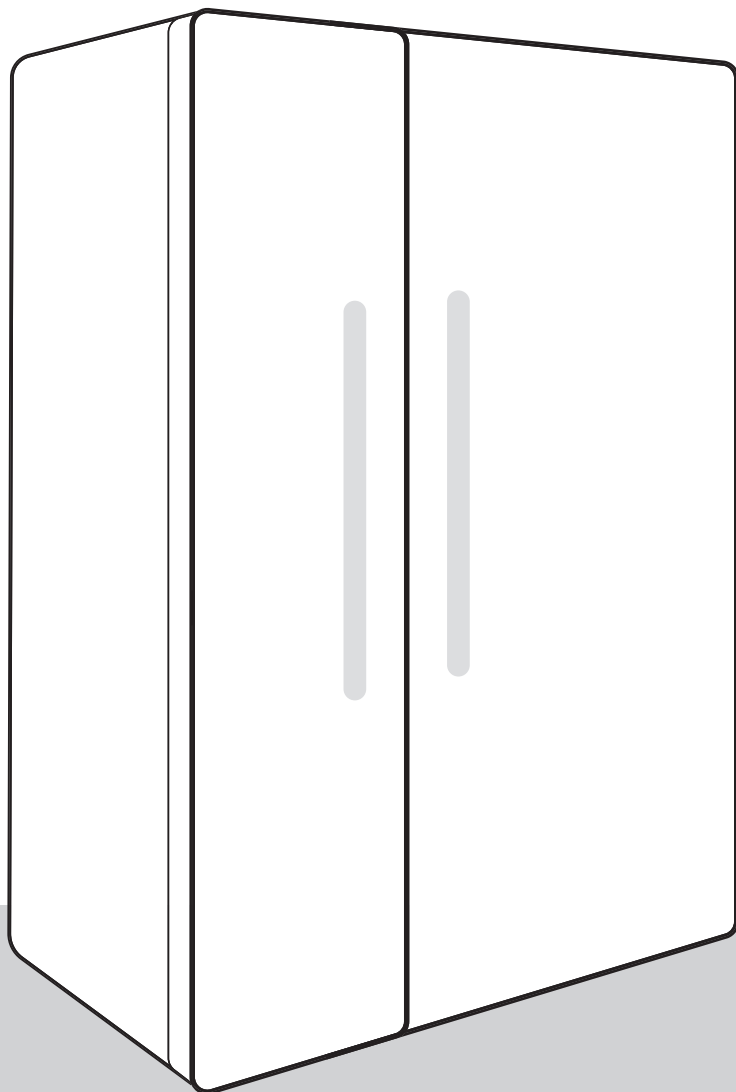

THANK YOU FOR WELCOMING OUR APPLIANCE INTO YOUR HOME

We are happy that you have chosen a Hisense appliance. Hisense is here to empower you and all your adventures with our cutting-edge technology and modern home appliances made of high-quality materials. Because we are working tirelessly on energy efficiency, by purchasing our appliance, you too are contributing to more sustainable future.

For full use of our services, warranty and other important information, please consider to register your Hisense appliance online on our website:

<https://www.hisense-europe.com>

We hope our appliance will meet and exceed your expectations.

Link to the EU EPREL database

The QR code on the energy label supplied with the appliance provides a web link to the registration of this appliance in the EU EPREL database. Keep the energy label for reference together with the user manual and all other documents provided with this appliance. It is possible to find information related to the performance of the product in the EU EPREL database using the link <https://eprel.ec.europa.eu> and the model name and product number that you can find on the rating plate of the appliance. For more detailed information about the energy label, visit www.theenergylabel.eu.

The appliance is intended solely for household use.

The refrigerator is intended for storing fresh food at temperatures above 0°C.

The freezer is intended for freezing fresh food and for long-term storage of frozen food (up to one year, depending on the type of food).

The following symbols are used throughout the manual and they have the following meanings:

 **INFORMATION!**
Information, advice, tip, or recommendation

 **WARNING!**
Warning – general danger

 **ELECTRIC SHOCK!**
Warning – danger of electric shock

 **DANGER OF FIRE!**
Warning – danger of fire

Contents

Important notes and precautions	4
Before using the appliance for the first time	4
Important safety instructions	4
Important information on the use of appliance	7
Environment protection	9
Advice for saving power with refrigeration appliances	9
Installation and connection	10
Selecting the room	10
Appliance placement	11
Connecting the appliance	13
Description of the appliance	14
Operating the appliance	15
Switching the appliance on/off	15
Adjusting the temperature in the appliance	16
Control unit/display standby mode	17
Intensive freezing (freezer compartment)	18
Eco function(Recommended setting)	19
Convert function	20
Holiday mode (prolonged absence)	21
High temperature alarm	22
Open door alarm	23
Power outage/power supply failure alarm	24
Appliance interior equipment	25
Shelves	25
Fruit and vegetables drawer (CrispZone) *	25
Door racks	25
Air distribution system (MultiFlow) *	25
Water dispenser *	26
Storing food in the refrigerator	28
Important warnings regarding food storage	28
Avoid contamination of food	28
Freezing and storing frozen food	28
Freezing procedure	28
Important warnings on freezing	29
Storing industrially frozen food	29
Frozen food storage time	29
Thawing frozen food	29
Defrosting the appliance	30
Automatic refrigerator defrosting	30
Defrosting a NoFrost freezer	30
Cleaning the appliance	30
Troubleshooting	31
Information about appliance noise	33

Important notes and precautions

Before using the appliance for the first time

Before connecting the appliance to the power mains, please read carefully the instructions for use which describe the appliance and its correct and safe use. The instructions apply to several appliance types/models; thus, settings or equipment may be described herein which is not available in your appliance. We recommend saving this instruction manual for future reference and attach it to the appliance if it is sold in the future.

The instruction manual includes the No Frost version/model of the freezer which is fitted with a fan and in which the defrosting process is automatic (only with some models).

Check for any damage or irregularities on your appliance. If you find your appliance is damaged, notify the retailer from which you have purchased the appliance.

Before connecting the appliance to the power mains, let the appliance rest in a vertical position for a minimum of 2 hours. This will reduce the possibility of operation faults due to the effect of transport on the cooling system.

Important safety instructions



 **DANGER OF FIRE!**
WARNING! Risk of fire/flammable materials.

The appliance must be connected to the power mains and grounded in compliance with the effective standards and regulations.

WARNING! Do not locate multiple portable socket-outlets or portable power supplies at the rear of the appliance.

Before cleaning the appliance, unplug it from the power mains (unplug the power cord from the wall outlet).

 **ELECTRIC SHOCK!**

WARNING! If the supply cord is damaged, it must be replaced by the manufacturer, its service agent or similarly qualified persons in order to avoid a hazard.

 **ELECTRIC SHOCK!**

WARNING! When positioning the appliance, ensure the supply cord is not trapped or damaged.

 **ELECTRIC SHOCK!**

If LED lighting does not work, call a service technician. Do not attempt a repair of the LED lighting yourself, as there is danger of contact with high voltage!

 **WARNING!**

WARNING! Do not use electrical appliances inside the food storage compartments of the appliance, unless they are of the type recommended by the manufacturer.

 **WARNING!**

WARNING! Do not use mechanical devices or other means to accelerate the defrosting process, other than those recommended by the manufacturer.

 **WARNING!**

WARNING! To avoid any hazard resulting from poor stability of the appliance, make sure it is installed as instructed.

Freeze burn hazard

To avoid freeze burn, never put frozen food in your mouth and do not touch frozen food.

Safety of children and vulnerable persons

The appliance is not intended for use by persons (including children) with reduced physical, sensory or mental capabilities, or lack of experience and knowledge, unless they have been given supervision or instruction concerning use of the appliance by a person responsible for their safety.

Children should be supervised to ensure that they do not play with the appliance.

Cleaning and user maintenance shall not be made by children without supervision.

Remove the packaging intended to protect the appliance or particular parts during transport and keep it outside the reach of children. It presents danger of injury or suffocation.

When removing a used appliance, disconnect the power cord, remove the door, and leave the shelves in the appliance. This will prevent children from locking themselves in the appliance.

For European markets only

This appliance can be used by children aged from 8 years and above and persons with reduced physical, sensory or mental capabilities or lack of experience and knowledge if they have been given supervision or instruction concerning use of the appliance in a safe way and understand the hazards involved.

Children shall not play with the appliance.

Cleaning and user maintenance shall not be made by children without supervision.

Children aged from 3 to 8 years are allowed to load and unload refrigerating appliances.

Warning regarding the refrigerant

The appliance contains a small amount of an environmentally friendly yet flammable gas R600a. Make sure that no parts of the cooling system are damaged. A gas leak is not hazardous to the environment, but it could cause eye injury or fire.

In case of a gas leak, ventilate the room thoroughly, disconnect the appliance from the power mains, and call a service technician.

Important information on the use of appliance



WARNING! This appliance is intended to be used in household and similar applications such as:

- staff kitchen areas in shops, offices and other working environments;
- farm houses and by clients in hotels, motels and other residential type environments;
- bed and breakfast type environments;
- catering and similar non-retail applications.

⚠ WARNING!

WARNING! Keep ventilation openings, in the appliance enclosure or in the built-in structure, clear of obstruction.

The appliance may not be used outdoors and it may not be exposed to rain.

Do not store explosive substances such as aerosol cans with a flammable propellant in this appliance.

If the appliance will be out of use for an extended period of time, switch it off using the relevant button, and unplug it from the power mains. Empty the appliance, defrost it, clean it, and leave the door ajar.

In case of an error or power supply failure, do not open the freezer compartment unless the freezer has not operated for over 16 hours. After this period, use the frozen food or provide sufficient cooling (e.g. a replacement appliance).

Technical information on the appliance

Rating plate can be found in the appliance interior. It indicates data on voltage, gross and net volume, type and amount of refrigerant, and information on the climate classes.

If the language on the rating plate is not the language of your choice or the language of your country, replace it with the one supplied.

⚠ WARNING!

WARNING! Do not damage the refrigerant circuit. This will also prevent pollution.

Environment protection

Packaging is made of environmentally friendly materials that can be recycled, disposed of, or destroyed without any hazard to the environment.

Removing an obsolete appliance

To protect the environment, take the obsolete appliance to an authorized home appliance collection centre.

Before doing so, do the following:

- disconnect the appliance from the power mains;
- do not allow children to play with the appliance.



The symbol on the product or its packaging indicates that the product should not be treated as normal household waste. The product should be taken to an authorized collection centre for waste electric and electronic equipment processing. Correct disposal of the product will help prevent any negative effects on the environment and health of people which could occur in case of incorrect product removal. For detailed information on removal and processing of the product, please contact the relevant municipal body in charge of waste management, your waste disposal service, or the store where you bought the product.

Advice for saving power with refrigeration appliances

- Install the appliance as specified in the instruction manual.
- Do not open the door more often than necessary.
- Occasionally make sure air circulation underneath the appliance is unobstructed.
- If the gasket is damaged or does not provide a perfect seal for any reason, have it replaced as soon as possible.
- Store the food in tightly sealed containers or appropriate packaging.
- Before placing the food in the refrigerator, allow it to cool down to room temperature.
- Defrost frozen food in the refrigerator compartment.
- To make use of the entire freezer compartment interior volume, remove some of the drawers as described in the instruction manual.
- Defrost your conventional freezer when an approximately 3–5 millimetre layer of frost or ice has built up on the refrigerated surfaces.
- Make sure the layout of shelves in the compartment is uniform and that the food is placed so that the air can freely circulate in the appliance interior (observe the recommended placement of food as described in the instructions).
- In appliances with a fan, do not block the fan slots or vents.
- If you do not need the fan or the ionizer, switch them off to reduce power consumption.

Installation and connection

Selecting the room

- Install the appliance in a dry and well ventilated room. The appliance will operate correctly if the environment temperature is in the interval specified in the table. The appliance class is indicated on the rating plate / label with the basic information on the appliance.

Description	Class	Ambient temperature range °C	Relative humidity
Extended temperate	SN	+10 to +32	≤75%
Temperate	N	+16 to +32	
Subtropical	ST	+16 to +38	
Tropical	T	+16 to +43	



INFORMATION!

This appliance is not intended to be used as a build-in appliance.



INFORMATION!

Do not place an appliance in a room where temperature can drop to below 5 °C as this may cause abnormal appliance operation or failure!

- After the installation, the appliance mains plug should be accessible!
- Do not place the appliance near appliances or devices radiating heat, such as a cooker, a stove, a radiator, water heater etc., and do not expose it to direct sunlight. The appliance should stand at least 3 cm away from an electric or gas cooker or at least 30 cm away from an oil or solid fuel stove. If the distance between such source of heat and the appliance is smaller, use an insulating panel.

Appliance placement

Appliance installation should be carried out by at least two persons to avoid any personal injury or damage to the appliance.

- The appliance is intended for free-standing installation. To reach the rated/minimum power consumption, always provide 50 mm of clearance between the wall and the back of the appliance, and 100 mm above the appliance. Also allow adequate air circulation on either side of the appliance and above it.
- The appliance can also be placed adjacent to or between kitchen cabinets or cupboards, or adjacent to a wall. In case of such placement, the appliance will operate flawlessly; however, power consumption could increase. Observe the minimum clearance above and behind the appliance, as indicated in the figure.
- Take into account the space or clearance required to open the appliance door, in order to allow the drawers and shelves to be pulled out or removed (see installation diagram).

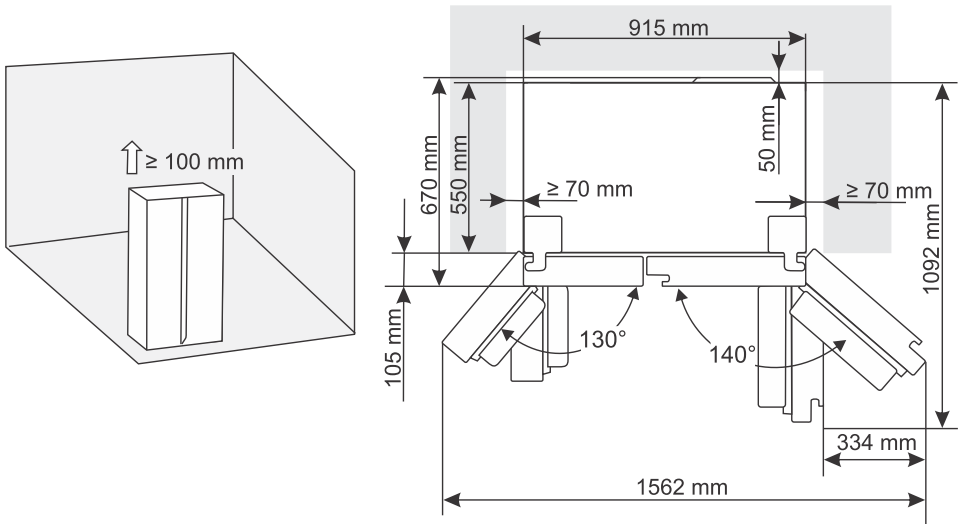

Appliance setup

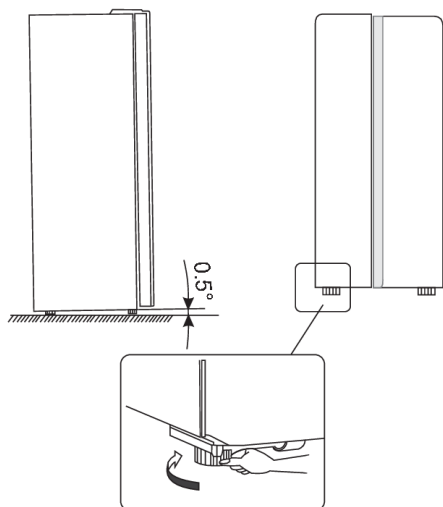

- To ensure that the appliance will stand horizontally and that sufficient air circulation is provided behind the appliance, the feet at the bottom of the appliance may need to be adjusted. The height of the feet can be adjusted with your fingers or using an appropriate wrench.
- Allow the door to close automatically. Then turn the adjustable feet so that the upper part of the appliance is tilted backwards by about 10 mm or by 0.5°.
- When you want to move the appliance, raise the feet again so that the appliance can move freely on rotating rollers. After moving the appliance to the desired position, re-align it.

! WARNING!

Attention! Use the rotating rollers only to move the appliance forward and backward, as they do not function as wheels. If you push the appliance to one side or the other, it can damage the floor and the rollers.

Adjusting the appliance door

If you find that the door of the appliance is not completely aligned (that the door of the freezer compartment and the refrigerator compartment are not at the same level), you can use the supplied tool to adjust the height of the door.

If the freezer door is higher than the refrigerator door. First, use the supplied tool to turn the screw on the lower hinge counterclockwise to raise the door. Then fix the nut with a screwdriver.

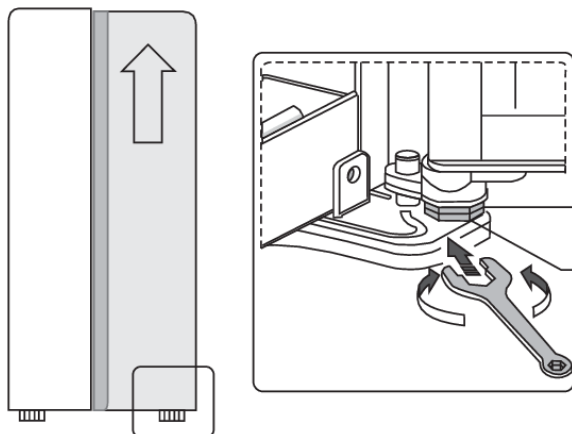

Connecting the appliance

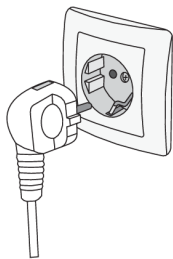

- Connect the appliance to the power mains using the power cord. The wall outlet should be fitted with a ground contact (safety socket). Nominal voltage and frequency are indicated on the rating plate/label with basic information on the appliance.
- The appliance must be connected to the power mains and grounded in compliance with the effective standards and regulations. The appliance will withstand short-term deviations from the nominal voltage, but not more than $\pm 6\%$.

Description of the appliance

Appliance interior equipment may change according to the appliance model.

This product contains a light source of energy efficiency class G.

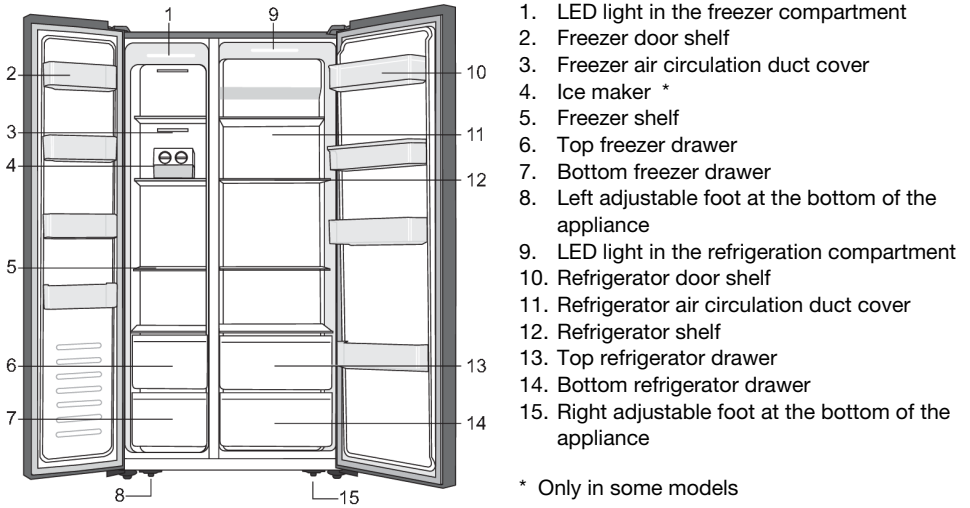

NOTE!

Due to occasional changes to our products, it is possible that your refrigerator will differ slightly from the refrigerator described in these instructions for use, but its functions and methods of use remain the same.

Operating the appliance

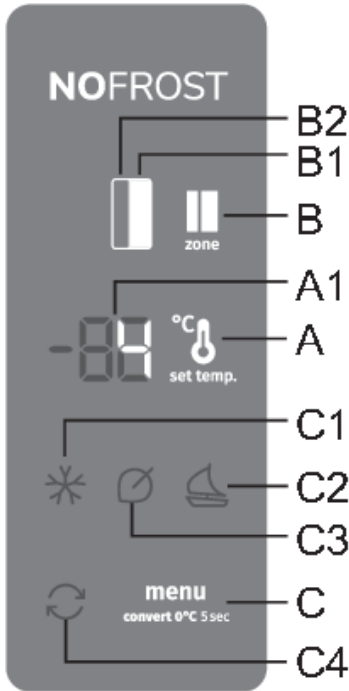

- A Temperature setting key
- A1 Display
- B Refrigerator/freezer compartment switch key
- B1 Refrigerator compartment display
- B2 Freezer compartment display
- C Key to set additional functions
- C1 Intensive freezing (fast freeze) function indicator
- C2 Long absence function indicator (holiday mode)
- C3 Eco function indicator
- C4 Function indicator convert

Switching the appliance on/off

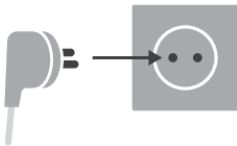

Power on: To switch on the appliance, plug the power cord into the power mains outlet.

Power off: To switch off the appliance, unplug the power cord from the power mains outlet.

Adjusting the temperature in the appliance

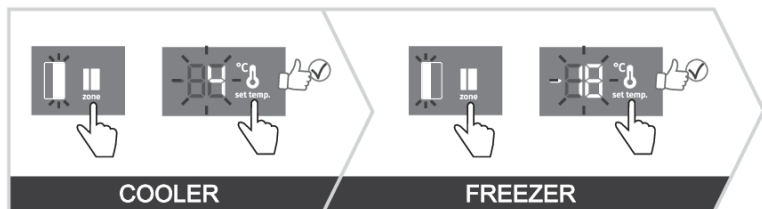

💡 INFORMATION!

- Appliance temperature is preset at the factory to the recommended setting, i.e. 4°C for the refrigerator compartment and -18°C for the freezer compartment.
- After the appliance is switched on, it may take several hours for the set temperature to be reached. Do not place any food into the refrigerator before the temperature drops to the selected setting.

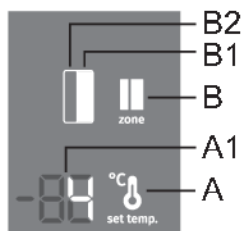

With this model, you can switch between setting the temperature of the refrigeration and freezer part. You can do this by pressing the **B** key to illuminate the symbol for the part of the appliance whose temperature you want to set: **B1** for the refrigeration part and **B2** for the freezer part.

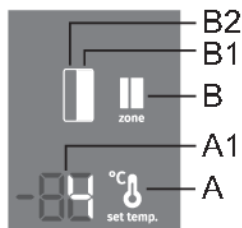

Temperature in the **refrigerator compartment** can be set when the **B1** symbol is lit. Set the temperature by briefly pressing the **A** key.

- Every time you press the **A** key, the temperature will be increased by 1 °C. The setting you choose will be stored as the most recent temperature set for the refrigerator compartment.
- Refrigerator compartment temperature can be set in the range from +1 °C to +9 °C.
- Recommended temperature setting is 4°C.

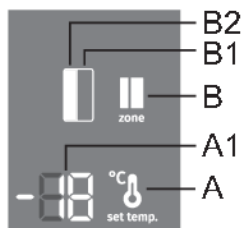

Temperature in the **freezer compartment** can be set when the **B2** symbol is lit. Set the temperature by briefly pressing the **A** key.

- Every time you press the **A** key, the temperature will be increased by 1 °C. The setting you choose will be stored as the most recent temperature set for the freezer compartment.
- Freezer compartment temperature can be set in the range from -16°C to -24°C.
- Recommended temperature setting is -18°C.



INFORMATION!

10 seconds after the most recent key is pressed, the freezer compartment display automatically switches back to refrigerator compartment display. **B1** will light up and the temperature set for the refrigerator compartment is displayed on the **A1** display unit.

Control unit/display standby mode



INFORMATION!

10 seconds after you have pressed the most recent key, the control unit switches to standby mode. All indicators on the control unit will be switched off. There are exceptions when some indicators remain lit although the control unit is in standby mode. Such exceptions include the following:

- If intensive freezing (freezer boost) is activated, then the indicator **C1** will remain lit. All other indicators are off.
- If the **Eco** function is activated, the indicator **C3** will still be displayed in standby mode. All other indicators are off.
- If the **holiday mode** function is activated, the indicator **C2** will still be displayed in standby mode. All other indicators are off.
- If the **convert** function is activated, the indicator **C4** will still be displayed in standby mode. All other indicators are off.
- If the manual freezer compartment defrosting function is activated, then **Cd** will still be displayed on the display unit, even when the control unit is in the standby mode. All other indicators are off.
- If one of the alarms is activated or if one of the faults is displayed, the display will show a specific message.

Exit standby mode: briefly press any key or open the door of the cooling compartment.

Intensive freezing (freezer compartment) (*)

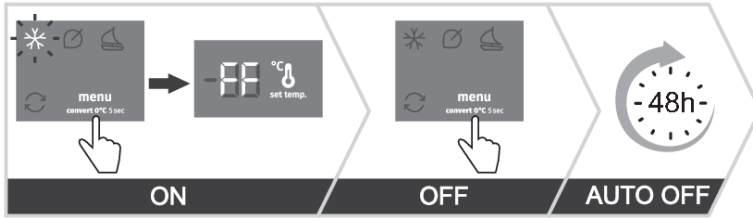

- Use this setting after switching on the appliance for the first time, before cleaning, or before inserting a large amount of food.

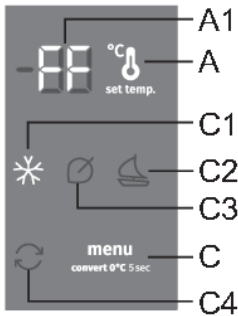

Power on: switch on the intensive freezing mode by pressing the key **C** as many times as it takes for the display to show **C1**. The display shows **FF**.

Power off: switch off the intensive freezing mode by pressing the **C** key again until the symbol **C1** goes out.

If the function is not deactivated manually, it will be deactivated automatically after approximately two days. The setting returns to the most recent value.

💡 INFORMATION!

- When the intensive freezing (fast freeze) function is activated, the appliance will operate with maximum power. During this time, operation may be temporarily somewhat louder.

💡 INFORMATION!

- When the intensive freezing (super freeze) function is activated, temperature may be lower both in the refrigerator and the freezer compartment.

Eco function (⊘) (Recommended setting)

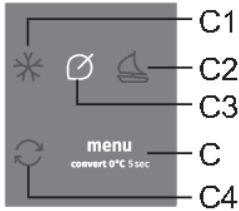
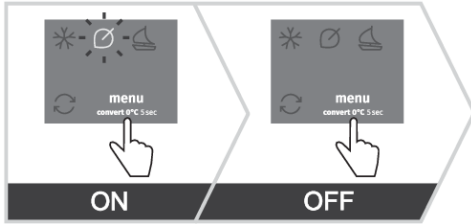

Power on: the **Eco** function is turned on by pressing the **C** key as many times as it takes for the display to show **C3**.

Power off: the **Eco** function can be switched off by pressing the **C** key again until the symbol **C3** goes out.

The **Eco** function will also be deactivated when you change the refrigerator or freezer compartment temperature setting, or when you activate any of the other extra functions.

Convert function (↻)

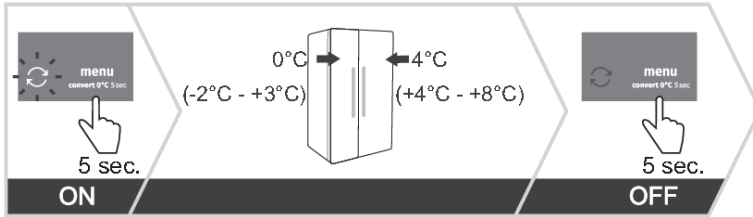

The entire freezer compartment can be converted into a **ZeroZone** compartment. The temperature in this compartment is at or slightly below 0°C. Therefore, do not store food that is sensitive to low temperature in this compartment as such food may freeze. Before switching to **ZeroZone** function, empty the freezer compartment to prevent the frozen food from defrosting and perishing.

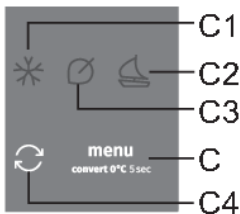

- **Switching on the function Convert:** with a long (5 second) press of the key **C**. You will hear a beep, and the display **C4** will light up.
- When this function is activated, the temperature in the freezer compartment will be set to 0°C, while the refrigerator compartment temperature will be set to 4°C. "0°C" will flash on the **A1** display until the temperature in the freezer compartment reaches the appropriate temperature. When this temperature is reached, the "0°C" indicator will be constantly lit.

- **Setting the temperature in the ZeroZone compartment:** use the **A** key to set the temperature between -2°C and +3°C.
- The temperatures are approximate and they depend on the temperature settings in the refrigerator compartment, environment temperature, frequency of door opening, and amount of food inserted. Setting a higher temperature in the **ZeroZone** compartment will also increase the temperature in the refrigerator compartment, and vice versa. Adjust the setting to the operating conditions.
- When the freezer is working in the **ZeroZone** mode, the temperatures in the refrigerator compartment can only be set in the range from 4 °C to +8 °C. We recommend such use only when environment temperature is between +16 °C and + 32 °C. At higher or lower temperatures, it is not possible to guarantee adequate temperature in the appliance.
- When the **Convert** function is activated, any other extra functions will be deactivated.
- **Switching off the function Convert:** by pressing the key again for a long time **C**. You will hear a beep and the display **C4** will turn off.

Holiday mode (prolonged absence)

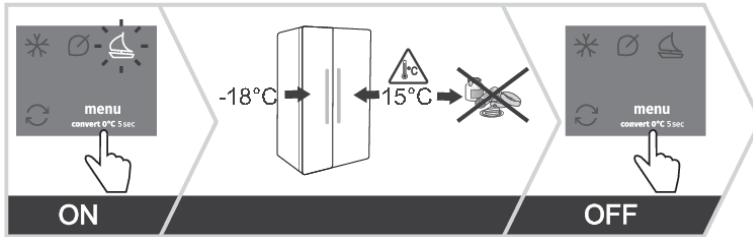

Use this function when you are away for a long period of time, for example when you are going on holiday or taking a long business trip.

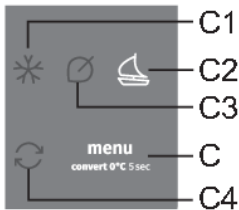

Power on: turn on the function by pressing the **C** key as many times as it takes for the display to show **C2**.

- When this function is activated, the refrigerator compartment temperature will be set to 15°C and the freezer compartment temperature will be set to -18°C.

WARNING!

Before activating this function, empty the refrigerator compartment, as any perishables left in this compartment may spoil.

Power off: turn off the function by pressing the **C** key again until the symbol **C2** goes out.

High temperature alarm

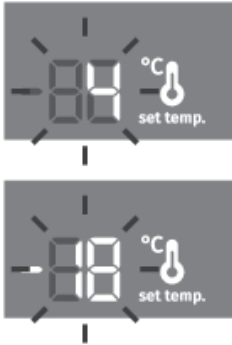
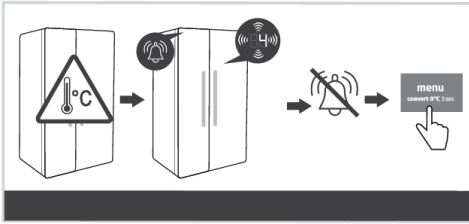

If the temperature inside the appliance is too high, the acoustic alarm will be activated (intermittent tone), and the set temperature of the compartment where the temperature is too high will flash on the display unit.

- Every time you switch on the appliance, a 24-hour delay in alarm operation is activated. If the appliance fails to reach a sufficiently low temperature after this period, the alarm will be activated.

Switching off the alarm:

- Acknowledge and turn off the acoustic alarm by pressing any key. Current temperature in the compartment where the temperature is too high will start to flash on the display unit. If you do not acknowledge and switch off the acoustic alarm, then it will be activated every hour for approximately 15 minutes.
- When the temperature drops to below the alarm value, then the temperature display will stop flashing and it will be lit continuously. Refrigerator compartment temperature will be displayed.

Open door alarm

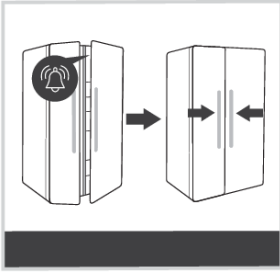

If the refrigerator or freezer compartment door is open for too long, an acoustic alarm (repetitive beep) will be activated and **B1** or **B2** icon on user interface will start to blink, depending on which door is open. If you do not acknowledge and switch off the acoustic alarm, then alarm will be activated every 30 seconds.

To switch off the alarm: to switch off the alarm, close the appliance door.



INFORMATION!

If you switch off the alarm by pressing any key, the alarm will be reactivated in 4 minutes if the door is still open.



INFORMATION!

If you leave the door open for more than 10 minutes, the alarm will no longer be sounded. Appliance operation will switch to safe mode in order to provide sufficient cooling and prevent food spoilage despite the open door.

Power outage/power supply failure alarm

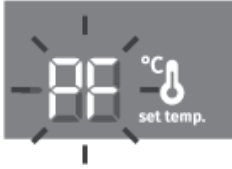
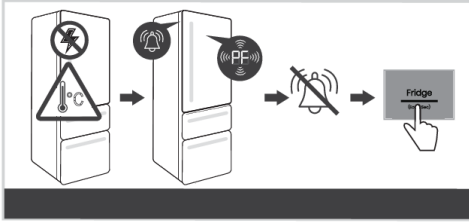

If the temperature in the appliance reaches the alarm level during a power failure, then the high temperature alarm will be activated once power supply is restored. The alarm will sound and the display will flash **PF**.

Deactivate the alarm by pressing any of the keys. The display shows the maximum measured temperature of the freezer compartment.

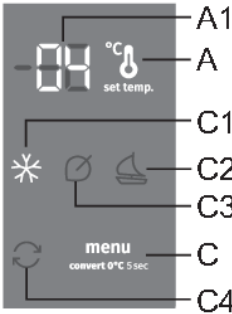

The next time you press the key, **A** the highest measured temperature of the refrigerator compartment will be displayed.

If you press the key **C** once more, the power supply failure alarm will be finally deactivated, and the set temperature for the selected compartment will appear on the display unit.

If the high temperature alarm is activated at the same time, it will operate as described in the chapter High temperature alarm, after you have deactivated the power supply failure alarm.

Appliance interior equipment

(* Equipment depends on the model)

Shelves

Empty shelves can be rearranged as you see fit across the guides in the appliance interior without having to remove them from the appliance. To move or remove a shelf from the appliance, pull it towards you, lift it up at the front and then move or pull it out of the appliance. Store quickly perishable food at the back of the shelf where the temperature is the lowest.

Fruit and vegetables drawer (CrispZone) *

The drawers at the bottom of the refrigerator are meant for storing fruits and vegetables. They provide humidity and prevent the food from drying out.

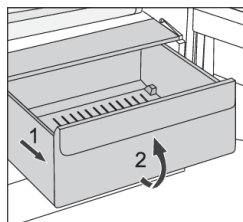

- Pulling out the bin:
 - Pull out the bin as far as it will go. Then, lift the front part and pull it out completely.

Door racks

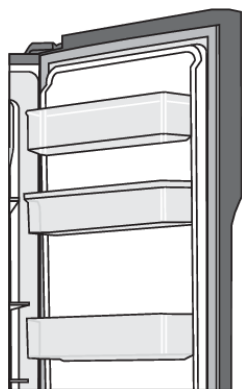

The inside of the door of the refrigerator and freezer compartment is equipped with shelves designed for storing small packages.

You may lay out the racks as desired by lifting them slightly from the grooves that hold them in place and moving them to the desired spot, making sure to fit them in the grooves there.

The lower shelf on the door of the refrigerator compartment is designed for storing bottles.

Maximum load on each door shelf is 5 kg.

Air distribution system (MultiFlow) *

- Advanced MultiFlow system evenly distributes the air and equalizes the temperature throughout the refrigerator. This system also allows placing any type of food on any shelf in the fridge, as there are not temperature differences between them.

Water dispenser *

(Only in some models)

The water dispenser installed in the door of the refrigeration compartment is designed for storing drinking water. With a water dispenser, you can easily get chilled water without having to open the door of the refrigeration compartment.

Before using the appliance for the first time

Before using the water dispenser for the first time, it must be cleaned according to the instructions below:

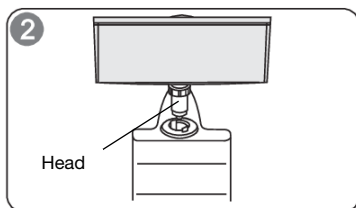
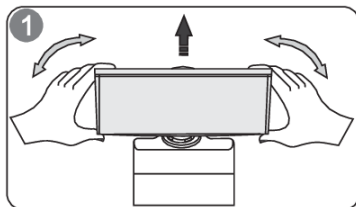

1. Hold the water dispenser on both sides and pull it upwards with a slight shake.
2. Unscrew the head and clean it, while also cleaning the inside of the water dispenser.

Installation

1. Insert the dispenser head into the opening.
2. Place the container in the guides on the refrigerator door.
3. Press both sides of the water container downwards.
4. When you hear a click, it means that the container is placed in its intended slot.

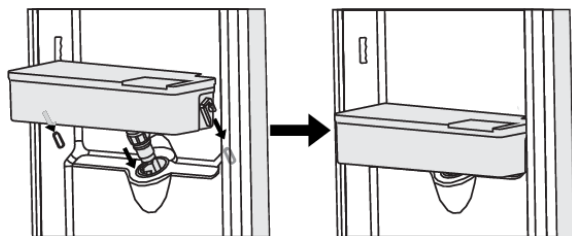

Warning!

1. Be careful not to press on the head.
2. When installing the water container, make sure to insert the head into the opening first.

Filling with water

Before filling the container with drinking water, make sure that the water container is firmly placed in the intended position.

Attention!

Pour up to 3 liters of water into the container (as recommended), but make sure that the water does not exceed the maximum level, otherwise it may spill over the edge when the lid is closed.

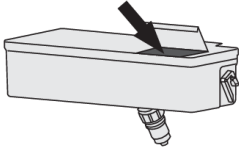

Open the lid and pour in the water. After pouring in the water, do not forget to close the lid completely again.

Water dispensing

1. Make sure that the water container lid is installed.
2. Close the refrigerator door and check the water dispenser.

Pouring water into a glass

Place a suitable glass under the cold water dispenser.



WARNING!

Do not press the dispenser lever if there is no glass under the tap, otherwise water may flow from the dispenser.

Cleaning

1. Carefully remove the water container from the refrigerator door. Gently clean the container, lid and head with water.
2. After cleaning the dispenser, allow it to dry or dry it with a dryer.
3. If you frequently use the cold water dispenser, a lot of water can accumulate in the drip tray of the dispenser tap, which can also get on the floor and make it wet. Regularly wipe the container with a dry cloth so as not to accumulate too much water in the tray.

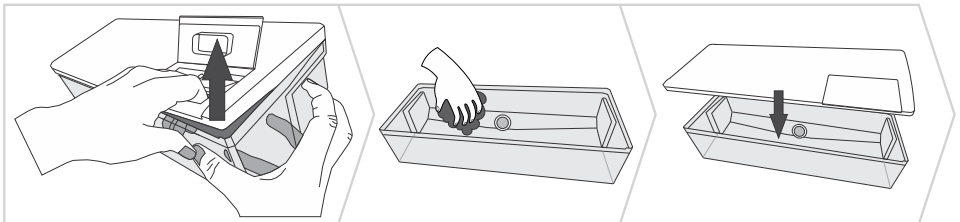

Storing food in the refrigerator

Important warnings regarding food storage

INFORMATION!

Correct use of the appliance, appropriate packaging, maintaining the right temperature, and observing the food hygiene standards have a decisive impact on the quality of food storage.

Observe the expiry dates for the food, indicated on the packaging.

Food stored in the refrigerator should be kept in closed containers or in appropriate packaging to prevent it from emitting or receiving odours and humidity.

Do not store inflammable, volatile, and explosive substances in the refrigerator.

Bottles with high alcohol content should be tightly sealed and stored in an upright position.

Some organic solutions, essential oils in lemon and orange peel, butter acid, etc. may damage the plastic surfaces in case of a prolonged contact, causing damage and premature ageing of these materials.

Unpleasant odour warns of lacking cleanliness of the appliance or perished contents (see chapter Cleaning the Appliance).

If you are leaving home for a longer period of time, remove perishables from the refrigerator.

Avoid contamination of food

To avoid contamination of food, please respect the following instructions:

- Opening the door for long periods can cause a significant increase of the temperature in the compartments of the appliance.
- Regularly clean surfaces that can come in contact with food and accessible drainage systems.
- Store raw meat and fish in suitable containers in the refrigerator, so that it is not in contact with or drip onto other food.
- If the refrigerating appliance is left empty for long periods, switch off, defrost, clean, dry, and leave the door open to prevent mould developing within the appliance.

Freezing and storing frozen food

Freezing procedure

INFORMATION!

Maximum amount of fresh food that may be inserted at once is specified on the appliance rating plate. If the amount of food to be frozen exceeds the indicated amount, the quality of freezing will be inferior; in addition, the quality of the food already frozen will deteriorate.

- Activate the super freeze function 24 hours before freezing fresh food:
 - press the **C** key as many times as it takes for the display to show **C1**
- Then you can put fresh food in the freezer area.

Make sure the fresh food is not in contact with the food that is already frozen.

- When freezing smaller amounts of food (1-2 kilograms), activating the super freeze function is not required.

Important warnings on freezing



INFORMATION!

Only use the freezer to freeze food appropriate for freezing. Always use quality and fresh food.

Select the most suitable packaging for the food and use the packaging correctly.

Make sure the packaging is air and water tight so that the food does not dry out and lose its vitamins.

Indicate the type of food, amount, and date of freezing on the packaging.

It is important that the food freezes quickly. Therefore, smaller packages are recommended. Refrigerate the food before freezing.

Storing industrially frozen food

- When storing and using frozen food, observe the manufacturer's instructions. Temperature and expiry date are indicated on the packaging.
- Only choose food with undamaged packaging, stored in freezers at temperatures of -18°C or lower.
- Do not purchase food covered in frost as this indicates it has been partly thawed several times and that it is of inferior quality.
- Protect the food from thawing during transport. In case of an increase in temperature, storage time will be shorter and quality will deteriorate.

Frozen food storage time

Recommended storage time in the freezer

Type of food	Storage life
Fruit, beef	from 10 to 12 months
Vegetables, veal, poultry	from 8 to 10 months
Venison	from 6 to 8 months
Pork	from 4 to 6 months
Finely chopped or minced meat	4 months
Bread, pastas, cooked dishes, whitefish	3 months
Offal	2 months
Smoked sausage, bluefish	1 month

Thawing frozen food

- Thawing is an important step in storing food preserved by freezing. Food must be thawed in the correct way.
- Suitable methods of thawing food are:
 - in the refrigerator;
 - in cold water;
 - in a microwave or conventional oven with a suitable thaw program.

- Some frozen products can be prepared without needing to thaw them first. The manufacturer will state this on the packaging.
- The food needs to be packed in small portions. In this way the food thaws faster.
- Use partially or completely thawed food as quickly as possible. The bacteria in thawed food are reactivated and the food will spoil rapidly. This applies in particular to fruit, vegetables and ready-made food.
- Do not refreeze partially or completely thawed food.

Defrosting the appliance

Automatic refrigerator defrosting

Refrigerator does not need defrosting because the ice on the back interior wall is thawed automatically. Any accumulated ice will melt when the compressor unit is inactive. Drops will flow through an opening in the refrigerator rear wall into a tray fitted above the compressor, from where they will evaporate.

Make sure the opening in the back wall in the refrigerator interior is never blocked by food or any other object.

If an excessive layer of ice is formed on the rear wall of refrigerator interior (3–5 mm), switch off the appliance and defrost the appliance manually.

Defrosting a NoFrost freezer

- The NoFrost freezer will defrost automatically. Any frost layer that may build up occasionally will disappear automatically.

Cleaning the appliance



WARNING!

Before cleaning, unplug the appliance from the mains - unplug the appliance and remove the connection cable from the socket.

- Use a soft cloth to clean all surfaces. Cleaners that contain abrasive substances, acids, or solvents are not suitable for cleaning as they may damage the surface.

Clean the appliance exterior with water or a mild solution of suds.

Lacquer-coated and aluminium surfaces may be cleaned with lukewarm water to which you have added a mild detergent. Use of cleaners with low alcohol content is allowed (e.g. window cleaners). Do not use cleaners containing alcohol for cleaning plastic materials.

Appliance interior can be cleaned with lukewarm water to which you can add some vinegar.

- Do not wash the parts of appliance interior equipment in a dishwasher as they may be damaged.
- Frost or ice build-up, 3–5 mm thick, will increase power consumption. Therefore, it should be regularly removed (does not apply to NO FROST freezers). Do not use any sharp objects, solvents, or sprays.
- After cleaning, switch the appliance back on and insert the food.

Troubleshooting

Problem:	Cause or remedy:
Appliance is connected to the power mains but it does not work.	<ul style="list-style-type: none"> • Make sure there is voltage in the power outlet and that the appliance is switched on.
Cooling system operates continuously for a long period of time:	<ul style="list-style-type: none"> • Too high environment temperature. • Door opened too frequently or too long. • Door not closed correctly (possible impurities on the seal, misaligned door, damaged seal etc.). • Too much fresh food inserted at once. • The sensor in the refrigerator is blocked by fresh food. Allow air to circulate around the sensor (only some models have it).
Excessive build-up of ice on the back wall of refrigerator interior can be a result of the following:	<ul style="list-style-type: none"> • door opened too frequently or too long. • Warm food placed in the refrigerator. • Food or containers in contact with the back interior wall of the refrigerator. • Poor door sealing. • If the seal is dirty or damaged, clean or replace it.
Build-up of ice or frost in the freezer interior:	<ul style="list-style-type: none"> • The door has been opened for too long or too frequently. • The door is not properly closed. • The door has a poor seal (the gasket is dirty, the door is not properly aligned, the gasket is damaged etc.). • Manually defrost the appliance.
Condensate (dew) on the shelf above the drawers:	<ul style="list-style-type: none"> • This is transient phenomenon which cannot be entirely avoided in periods of high environment temperature and humidity. It subsides when temperature and humidity are normalized. We recommend cleaning the drawers more frequently and wiping the droplets occasionally. • Open the humidity control slider. • Put food in bags or other packaging with a good seal.
Droplets on the refrigerator compartment back wall.	<ul style="list-style-type: none"> • This is normal. The refrigerator compartment is defrosted automatically, which results in droplets of water that flows through an opening in the refrigerator compartment back wall into a tray above the compressor unit, from which it evaporates.
Water is dripping/leaking from the refrigerator:	<ul style="list-style-type: none"> • Clogged water discharge opening or water dripping past the water gutter. • Clean the blocked opening, e.g. using a plastic straw. • If a thick layer of ice builds up, defrost the appliance manually (see Defrosting the Appliance).

Table continued from last page

Problem:	Cause or remedy:
Door is difficult to open:	<ul style="list-style-type: none"> • If you are trying to open the freezer door after just having closed it, this could be difficult to do. As you open the door, some cool air escapes from the appliance and it is replaced by warm air from the environment. When this air is cooled, negative pressure is generated which results in problems as you try to open the door. After a few minutes, the condition is normalized and the door can be easily opened again.
Appliance sides are warm:	<ul style="list-style-type: none"> • This is normal. There are pipes and tubes installed in the appliance sides, which tend to heat up during appliance operation.
LED lighting does not work:	<ul style="list-style-type: none"> • If LED lighting does not work, call a service technician. • Do not attempt a repair of the LED lighting yourself, as there is danger of contact with high voltage!
HI will appear on the display unit:	<ul style="list-style-type: none"> • Door opened too frequently or too long. • Door not closed correctly (possible impurities on the seal, misaligned door, damaged seal etc.). • An extended power failure. • Too much fresh food inserted at once.
PF will appear on the display unit:	<ul style="list-style-type: none"> • An extended power failure.
E0 or E8 appears on the display unit:	<ul style="list-style-type: none"> • Sensor keys are not responding. Call a service centre for repair. • Until the appliance is repaired by a service technician, the appliance will operate in safe mode. The appliance will automatically preserve the most suitable temperature for each compartment.
E1 or E2 appears on the display unit:	<ul style="list-style-type: none"> • Temperature sensor error or fault. Call a service centre for repair. Until the appliance is repaired by a service technician, the appliance will operate in safe mode. The appliance will automatically preserve the most suitable temperature for each compartment.
E3 or E4 appears on the display unit:	<ul style="list-style-type: none"> • Compartment fan failure. Call a service centre for repair. The appliance cannot operate normally. Transfer the food to a cool place and switch off the appliance.
E6 will appear on the display unit:	<ul style="list-style-type: none"> • Evaporator sensor is defective. Call a service center to fix the problem. The appliance will operate in safe mode until it is repaired by a service technician. The appliance will automatically maintain the most suitable temperature for each compartment.

Table continued from last page

Problem:	Cause or remedy:
E7 will appear on the display unit:	<ul style="list-style-type: none">• Ambient temperature sensor is malfunctioning. Call a service center to fix the problem. The appliance will operate in safe mode until it is repaired by a service technician. The appliance will automatically maintain the most suitable temperature for each compartment.
E9 appears on the display unit:	<ul style="list-style-type: none">• Door was open for too long. Close the door.• If the door is not open, or if E9 is still displayed 10 minutes after you have closed the door, then there is a door sensor failure. Call a service centre to arrange a repair. The appliance will operate in safe mode until it is repaired. The appliance will automatically preserve the most suitable temperature for each compartment.

If the above tips do not resolve your problem, call the nearest authorized service centre and state the type, model, and serial number indicated on the appliance rating plate or label located in the appliance interior.

Information about appliance noise

Cooling in refrigerator freezers is made possible by a cooling system that also includes a compressor (and a fan with some appliances), which generates some noise. The level of noise depends on installation, proper use, and age of the appliance.

- After connecting the appliance to the power mains, compressor operation, or the sound of flowing liquid, may be somewhat louder. This is not a sign of malfunction and it will not affect the useful life of the appliance. In time, appliance operation and this noise will become quieter.
- Sometimes, unusual or loud noises may appear during appliance operation; these are mostly the result of improper installation:
 - The appliance must stand level and stable on a solid base.
 - The appliance may not be in contact with a wall or adjacent furniture.
 - Make sure the interior equipment sits firmly in its place and that the noise is not caused by rattling cans, bottles or other containers placed next to each other.
- Due to the higher workload on the cooling system when the door is opened more frequently or for a longer time, when a large amount of fresh food is introduced or when intensive freezing or cooling functions are activated, the appliance can temporarily generate more noise.

gorenje

GORENJE gospodinjski aparati, d.o.o. Address: Partizanska 12, 3320 Velenje, Slovenia
Phone: +386 (0)3 899 10 00 Fax: +386 (0)3 899 28 00 www.gorenje.com



895607-a4

