

1. About Your Omni C28

1.1 What's in the Box

1.2 Overview

1.3 Button Controls

1.4 LED Indication

2. Preparing Your Omni C28

2.1 Install the Omni Station

2.2 Charge Your RoboVac

2.3 Download the eufy App

2.4 Reset the Wi-Fi Connection

3. Using Your Omni C28

3.1 Important Tips Before Use

3.2 Mapping

3.3 Set Up No-Go Zone and No-Mop Zone

3.4 Schedule Cleaning

3.5 Select a Cleaning Mode

4. Using the Mopping System

5. Using RoboVac with Alexa, Siri, or Google Assistant Compatible Devices

6. Enabling / Disabling Child Safety Lock

7. Cleaning and Maintenance

7.1 Clean the Dirty Water Reservoir

7.2 Clean the Dustbin and Filter

7.3 Replace the Roller Mop

7.4 Clean the Side Brush

7.5 Clean the Rolling Brush

7.6 Clean the Sensors, Cameras, and Charging Pins

7.7 Clean the Scraper

7.8 Clean the Swivel Wheel

7.9 Replace the Dust Bag

7.10 Clean the Cleaning Tray

7.11 Clean the Dirty Water Tank

8. Troubleshooting

9. Specifications

10. Customer Service

1. About Your Omni C28

1.1 What's in the Box



Omni Station



Robot Vacuum Cleaner (RoboVac)

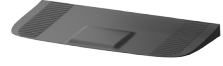

Detachable Base

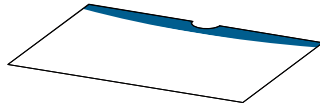

Quick Start Guide



Safety Sheet

1.2 Overview

1.2.1 RoboVac

Front



- ① Line Laser Sensor
- ② Bumper
- ③ Navigation Lidar
- ④ Robot Cover
- ⑤ Dustbin
- ⑥ Power Button
- ⑦ Recharge Button
 - Press to start cleaning, and press again to return RoboVac to the Station.

Back



- 1 Charging Contact Pins (×2)
- 2 Dirty Water Reservoir Button
- 3 Dirty Water Collection Port
- 4 Water Injection Port
- 5 Air Outlets

Bottom

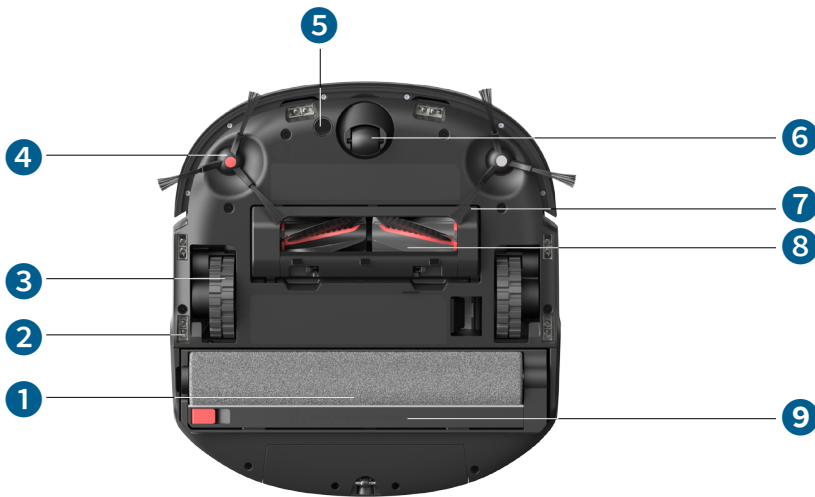



- 1 Roller Mop
- 2 Drop Sensors (×6)
- 3 Wheels (×2)
- 4 Side Brushes (×2)
- 5 Carpet Detection Sensor
- 6 Swivel Wheel
- 7 Brush Guard
- 8 DuoSpiral™ Brushes
- 9 Scraper

1.2.2 Omni Station

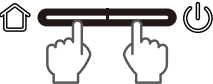

1.3 Button Controls

	<ul style="list-style-type: none"> • Long press (3s): Power on or off • Short press: Pause / resume the current task when working
	<ul style="list-style-type: none"> • Short press: Press to start cleaning, and press again to return RoboVac to the Station. • Long Press (14s) when RoboVac is in the Omni Station: Enter low power mode. *To exit the low power mode, long press the Power Button for 2 seconds.
	<ul style="list-style-type: none"> • Long press simultaneously (3s): Reset the Wi-Fi connection • Long press simultaneously (10s): Reset to factory settings

1.4 LED Indication

You can see the status of RoboVac and Omni Station from the LED indicators.

	LED Indication	Description	Status
RoboVac		Pulsing white	Powered On
		Steady white	Working normally
		Breathing red	Low battery
		Steady red	<ul style="list-style-type: none"> Low battery Error (Please refer to in-app instructions for solutions)
		Flashing red quickly	Error (Please refer to in-app instructions for solutions)
Omni Station		Lights up in white	Powered on
		Steady white	Working normally
		Breathing white	Dust collection / Mop cleaning
		Steady red	Error (Please refer to in-app instructions for solutions)
		Off	Power disconnected

2. Preparing Your Omni C28

2.1 Install the Omni Station

1. Remove the protective film on the Omni Station.



- When peeling off the sticker on the cleaning tray, press down on the cleaning tray to prevent it from coming loose.

2. Install the detachable base by pressing down firmly on both sides.



- Make sure the detachable base is seamlessly connected to the Omni Station; otherwise, the robot will fail to return to the Omni Station smoothly.

3. Place the Omni Station in a location that has strong Wi-Fi signal and the robot can easily access. It is recommended to place it against a wall and on a hard, level surface. Then, plug the station into a wall outlet. When the Omni Station connects to AC power, the LED indicator will light up in white.

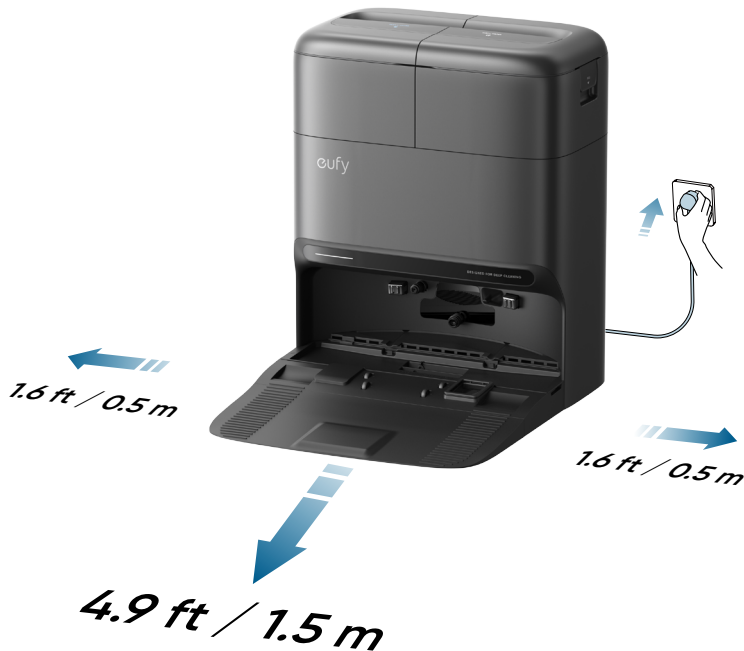

- The recommended clearance on the illustration is a suggested value based on testing, to ensure the robot operates optimally, returns to the station for charging, and cleans the designated area effectively. You may adjust the clearance distance as necessary to suit the actual working environment of the robot.
- Do not place the station on carpets.
- Always keep the station plugged in to ensure the infrared connection between the robot and the station is successful, otherwise the robot will not automatically return to it.

4. Take out the clean water tank. Add clean water until it reaches the MAX water line.

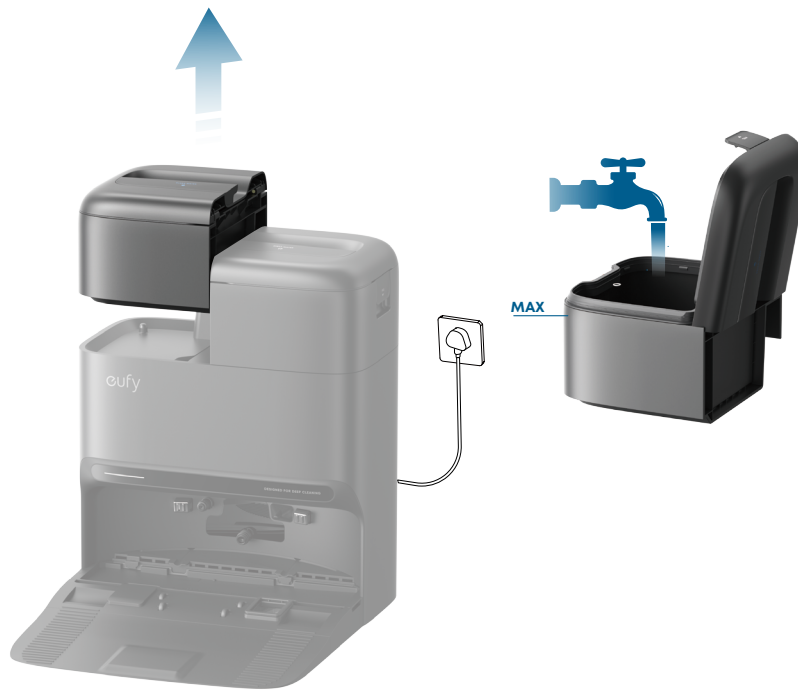

- Please do not add hot water into the tank to avoid shortening its service life.
- Please do not add non-eufy cleaning solutions or homemade cleaning liquids to avoid damaging the machine.

5. Reinstall the clean water tank. Ensure that both the clean water tank and dirty water tank are securely locked; otherwise, the station will not operate normally during subsequent use.



2.2 Charge Your RoboVac

1. Remove the foam blocks and protective film from the robot.



2. Attach the robot to the Omni Station. Then the robot will automatically power on.



- Fully charge the robot before use to ensure optimal performance.
- Upon successful docking, you'll hear a voice prompt of "charging".

2.3 Download the eufy App

To enjoy all the available features, it is recommended to download the eufy app.

1. Download the app from the App Store (iOS devices) or Google Play (Android devices). You can also get the app by scanning the QR code printed on the Quick Start Guide (included in the package).
2. Open the app. Create a new account or log into your own eufy account.

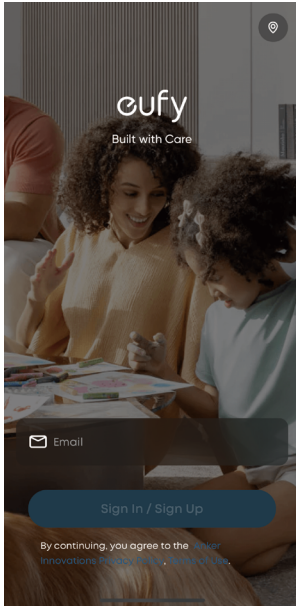

3. Tap the "+" icon to add the device.

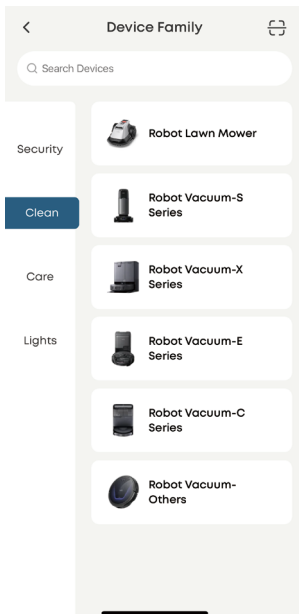

4. Follow the instructions in the app to set up the 2.4G Wi-Fi network.

- Use a 2.4GHz network.
- Do not use a VPN or proxy servers.
- The Wi-Fi name cannot contain special characters.
- If you still cannot connect, please contact us.

2.4 Reset the Wi-Fi Connection

If you bump into issues when connecting your RoboVac to the app, try to reset the Wi-Fi connection.

Press and hold the Recharge and Power buttons simultaneously for 3 seconds until you hear a voice prompt.



You will hear a voice prompt when the Wi-Fi connection has been reset, and the LED indicators on RoboVac will quickly flash white. Now you can follow the instructions in the app to set up the Wi-Fi connection.

3. Using Your Omni C28

 • All UI images shown in this section are for illustration only, and they may be subject to change due to software updates. Please refer to the actual app interface for the most accurate information.

3.1 Important Tips Before Use

- Remove power cords and small objects from the floor that may entangle RoboVac.
- Fold tasseled edges of rugs underneath to prevent tangling RoboVac. Avoid cleaning high-pile rugs or rugs thicker than 0.71 in / 18 mm as they may cause RoboVac to malfunction.
- It is strongly recommended to place physical barriers in front of fireplaces and certain areas (i.e. air vents) that may cause damage to RoboVac if entered.
- Avoid vacuuming large amounts of water as it will potentially damage the device.
- RoboVac may climb on top of objects less than 0.79 in / 20 mm in height. Remove these objects if possible.
- Anti-drop sensors will prevent RoboVac from tumbling down stairs and steep drops in most cases. Sensors are less effective if dirty or used on carpeted / reflective floors. Place physical barriers or set a "No-Go" zone to block off areas where RoboVac may fall.

3.2 Mapping

This feature is designed to help your RoboVac efficiently learn the layout of your home, ensuring thorough and systematic cleaning. By creating a detailed floor plan, your RoboVac can navigate and clean with precision.

To maximize the efficiency and accuracy of the mapping process, please follow these steps:

- Open All Doors:** Ensure all doors within the cleaning area are open. This allows the robot to access and map each room seamlessly.
- Block Off Restricted Areas:** If there are specific zones you don't want the robot to enter, use physical barriers to block these areas. This can enhance mapping accuracy and prevent the robot from entering unwanted spaces. After the mapping is completed, you can remove physical barriers, and set up restricted areas to prevent the robot from entering those areas.
- Remove Obstacles:** Clear any objects, such as toys, cables, or small furniture, that might obstruct path or become entangled in its brushes. This helps RoboVac move freely and map the area without interruptions.

- **Do Not Move the Base Station:** Once the floor plan is created, avoid relocating the base station. RoboVac relies on the base station as a reference point for navigation and mapping. Moving it may disrupt the accuracy of the floor plan.

To start the mapping process, tap "Start" in the app.

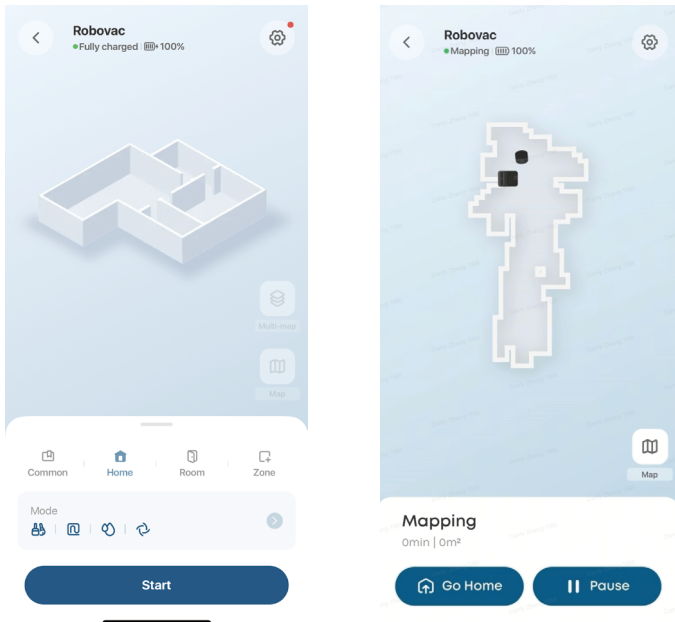

3.3 Set Up No-Go Zone and No-Mop Zone

With the eufy app, you can set up a "No-Go Zone" or "No-Mop Zone" as a restricted area. This eliminates the need to use physical barriers, including boundary strips. This feature is only designed for dividing the cleaning zones, not for isolating hazardous areas.

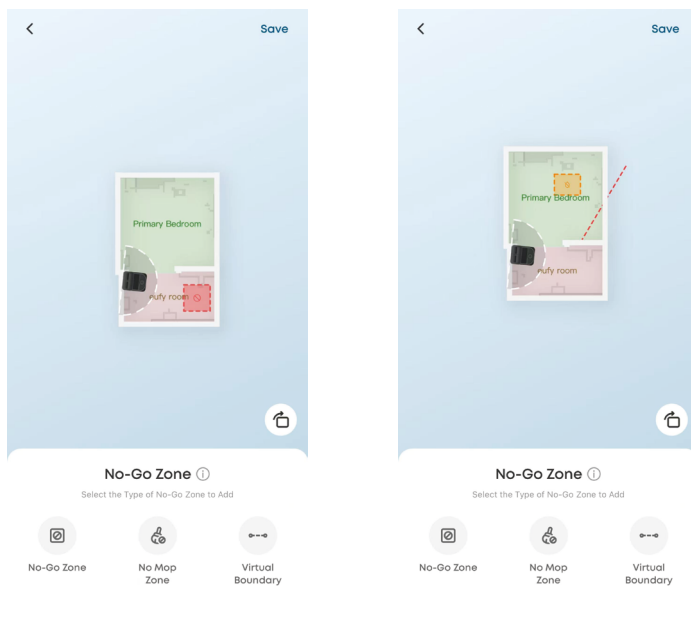

3.4 Schedule Cleaning

With the eufy app, you can schedule RoboVac to start cleaning at a particular time.

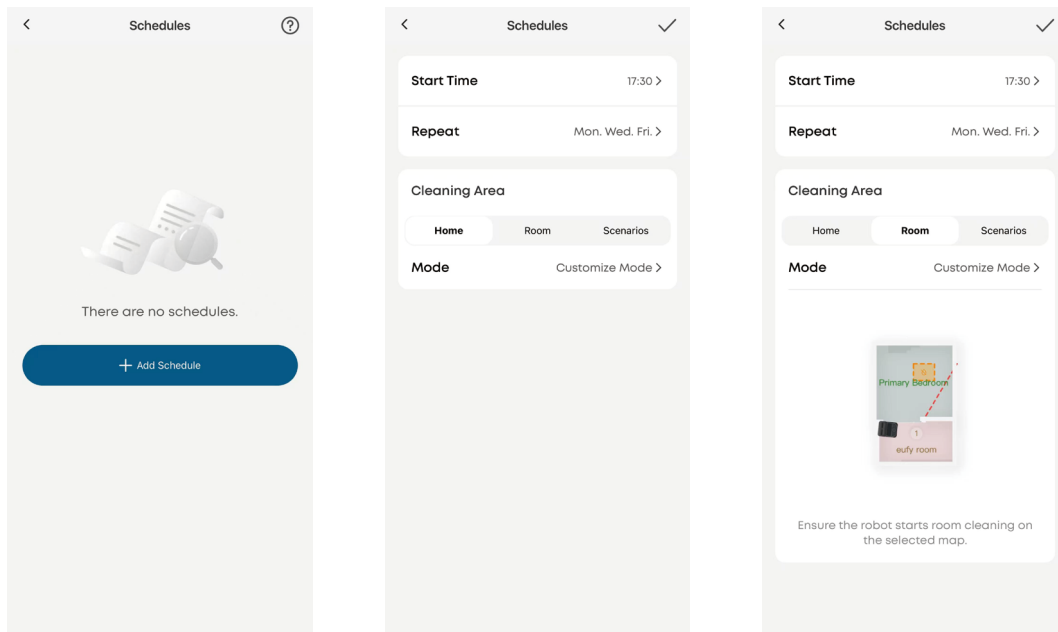

- 💡 You can set the time and customize cleaning schedules from Sunday to Saturday on the eufy app. This function is only available on the app.
- During the Do Not Disturb period, RoboVac will remain silent, with automatic dust collection and voice notifications disabled.

3.5 Select a Cleaning Mode

You can start / pause cleaning or select the desired cleaning mode via the eufy app.

In each cleaning mode, you can further customize the modes, cleaning intensity, water level, suction level, and other settings.

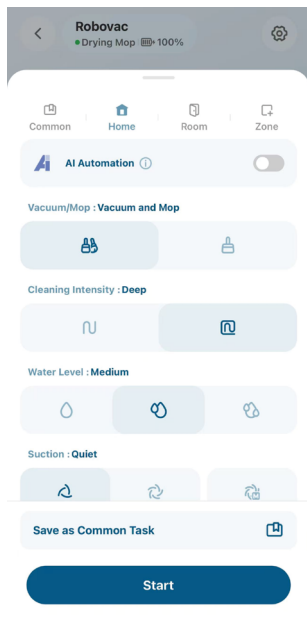

3.5.1 House Cleaning Mode

Tap "Start" in the eufy app to enable House Cleaning mode.

After startup, RoboVac moves from the Omni Station and automatically determines its cleaning route. When cleaning is finished, RoboVac automatically returns to the Omni Station.

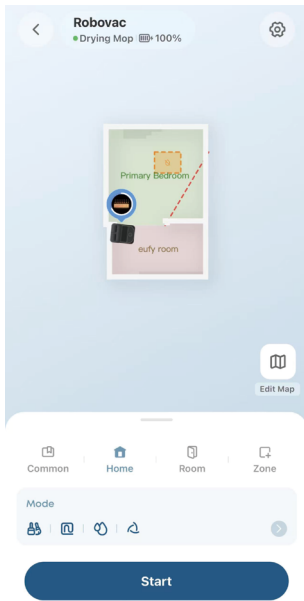

3.5.2 Room Cleaning Mode

In this mode, your house is automatically divided into several rooms for cleaning in the eufy app. You can also customize your room settings in the app. RoboVac will clean the selected rooms only and return to the Omni Station after cleaning.

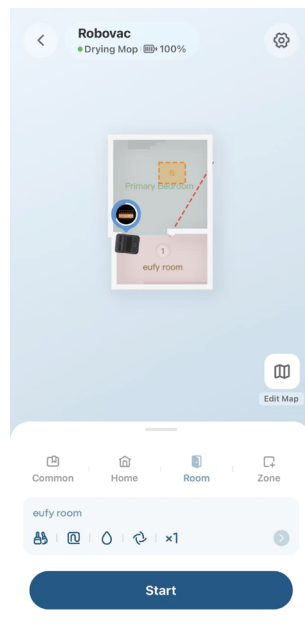
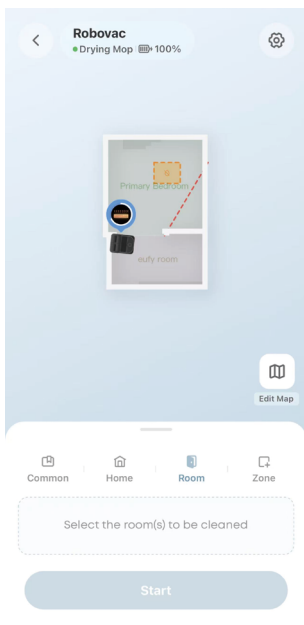

- Enable Room Cleaning mode only after RoboVac has created the map.
- It is recommended that RoboVac moves from the Omni Station to start room cleaning.

3.5.3 Zone Cleaning Mode

In this mode, you can set up a cleaning zone and customize its size in the eufy app, RoboVac will clean the selected zone only.

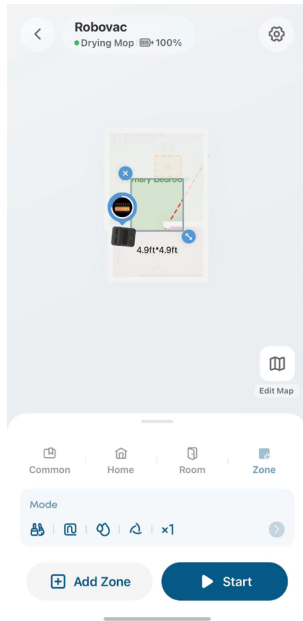

4. Using the Mopping System

1. Start cleaning. RoboVac will automatically vacuum and mop. During mopping, you can choose between three water levels via the eufy app.
2. To prevent the development of odors in the roller mop, be sure to activate the drying function after each mopping task. We strongly recommend setting the drying mode to "**Standard Drying**" every time to ensure optimal drying results and reduce unpleasant smells.
3. Regularly empty and clean the dirty water tank to prevent mildew or unpleasant smells. For instructions on how to clean the dirty water tank, refer to the "**Cleaning and Maintenance**" section in this User Guide.

5. Using RoboVac with Alexa, Siri, or Google Assistant Compatible Devices

With Alexa, Siri, and Google Assistant compatibility, your RoboVac is just a voice command away from cleaning every corner of your house.

Before you start, make sure:

- RoboVac is attached to the Omni Station to ensure there is enough power.
- RoboVac is connected with the eufy app.
- To control your RoboVac with Siri, make sure you have an iPhone or iPad running a recent version of iOS.

To control RoboVac with Alexa, Siri, or Google Assistant:

1. Click on the top left corner of eufy app's main interface, then find "**Smart Integrations**" in the dropdown menu.
2. Follow the on-screen instructions to complete the setup.

6. Enabling / Disabling Child Safety Lock

Activate the child safety lock in the eufy app: **More Settings > Child Lock**

Once the child safety lock is enabled, all buttons will be locked to prevent children from damaging the device or accidentally getting hurt.

 • Network configuration and factory reset are not affected by the child safety lock.

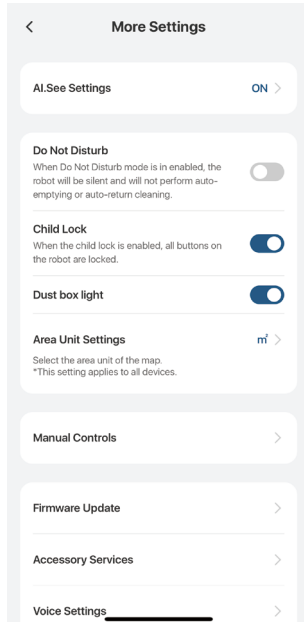

7. Cleaning and Maintenance

Before cleaning and maintaining, power off the device and unplug the power adapter. Any other servicing should be performed by an authorized service representative.

For optimal performance, follow the instructions below to clean and maintain Omni C28 regularly. The cleaning and replacement frequency will depend on your usage habits.

Recommended Cleaning and Replacement Frequency

Module	Components	Cleaning Frequency	Replacement Frequency
Robot	Dirty Water Reservoir	Clean it when prompted by the app, about every 30 hours	-
	Dustbin	Every 30 hours	-
	Roller Mop	-	Every 60 hours (or when visbly worn)
	Side Brush	Every 60 hours	Every 180 hours
	Rolling Brush	Every 60 hours	Every 180 hours
	Sensors	Every 360 hours	-
	Dirty Water Reservoir Filter	-	Every 180 hours
	Scraper	Every 30 hours	-
	Swivel Wheel	Every 60 hours	-
Omni Station	Dust Bag	-	Replace as needed
	Cleaning Tray	Every 30 hours	-
	Clean Water Tank	Clean it based on actual conditions	-
	Dirty Water Tank	Clean it based on actual conditions	-

7.1 Clean the Dirty Water Reservoir

- 1 Remove the dirty water reservoir by pressing the release button.
- 2 Detach the filter from the reservoir.
- 3 Fill the reservoir with clean water and shake to clean thoroughly.
- 4 Empty the water after cleaning, and wipe the suction port of the dirty water reservoir.
- 5 Reinstall the filter and the dirty water reservoir.

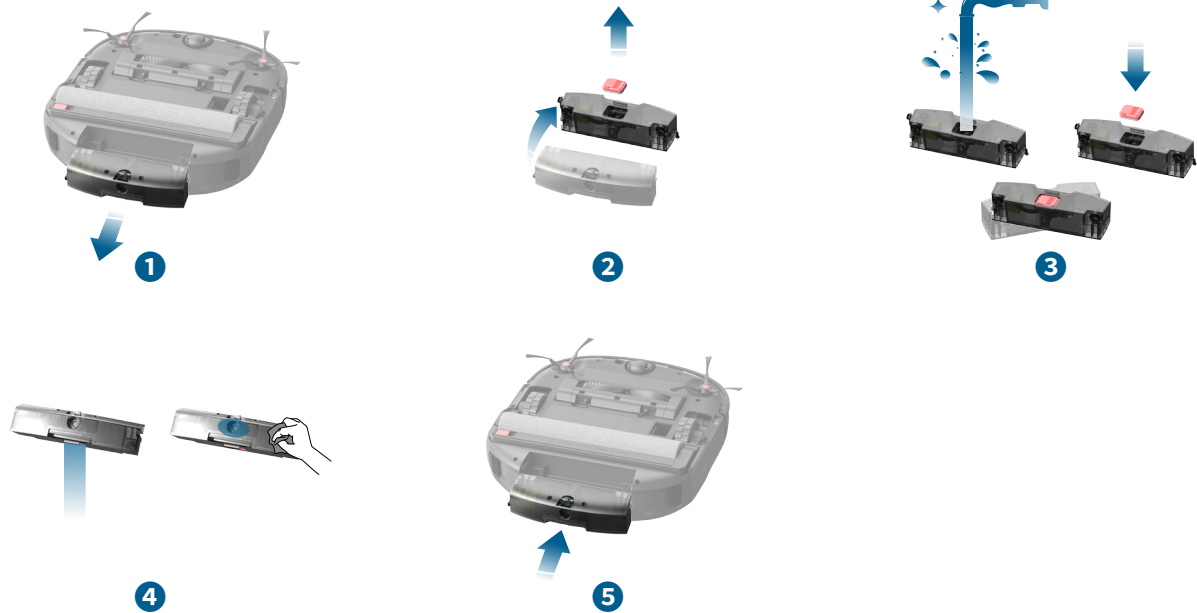

7.2 Clean the Dustbin and Filter

- 1 Open the robot cover and take out the dustbin.
- 2 Pull the release latch to open the cover. Take out the filter.
- 3 Empty the dustbin.
- 4 Tap the filter to remove dust.
- 5 Rinse the dustbin and filter thoroughly with water.
- 6 Air-dry the dustbin and filter completely before next use.
- 7 Place the filter back into the dustbin.
- 8 Push the dustbin back into the main unit, and close the robot cover.



1



2



3



4



5



6



7



8

- Do not use the filter if it is not completely dry, otherwise it may affect the cleaning performance.
- Do not use a brush, hot water, or any detergent to clean the filter.

7.3 Replace the Roller Mop

- 1 Power on. The roller mop bracket will pop out after the machine is flipped.
- 2 Remove the scraper.
- 3 Remove the roller mop.
- 4 Wipe the inside of the roller mop with a damp paper towel.
- 5 Place the new mop and press down until you hear a "click".
- 6 Reinstall the scraper.

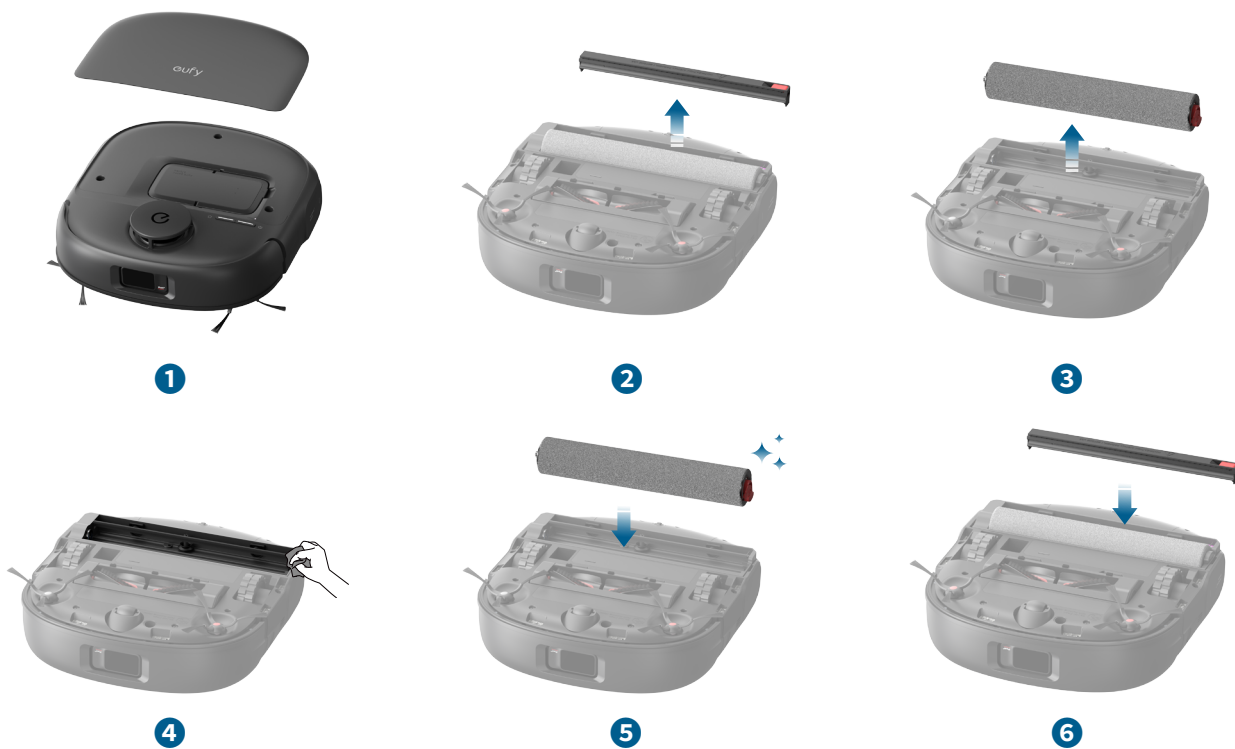

7.4 Clean the Side Brush

Foreign substances, such as hair, can easily get tangled in the side brush, so it is best to clean them regularly.

- 1 Remove the side brush.
- 2 Carefully unwind and pull off any hair or substances attached to the side brush.
- 3 Clean the side brush with water.
- 4 Air dry the side brush before next use.
- 5 Reinstall the side brush on the machine.



1



2



3

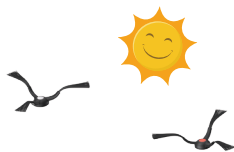

4



5

7.5 Clean the Rolling Brush

- 1 Push the release tabs to unlock the brush guard.
- 2 Push the side of one rolling brush inward and gently flip it up.
- 3 Gently twist and pull out the rolling brush.
- 4 Push the side of the other rolling brush inward and gently flip it up.
- 5 Gently twist and pull out the other rolling brush.
- 6 Rinse both rolling brushes and brush guard with running water. Air dry the rolling brushes and brush guard completely before next use.
- 7 Reinstall one side of the rolling brush and snap it into place.
- 8 Reinstall the other side of the rolling brush and snap it into place.
- 9 Press down to snap the brush guard into place.

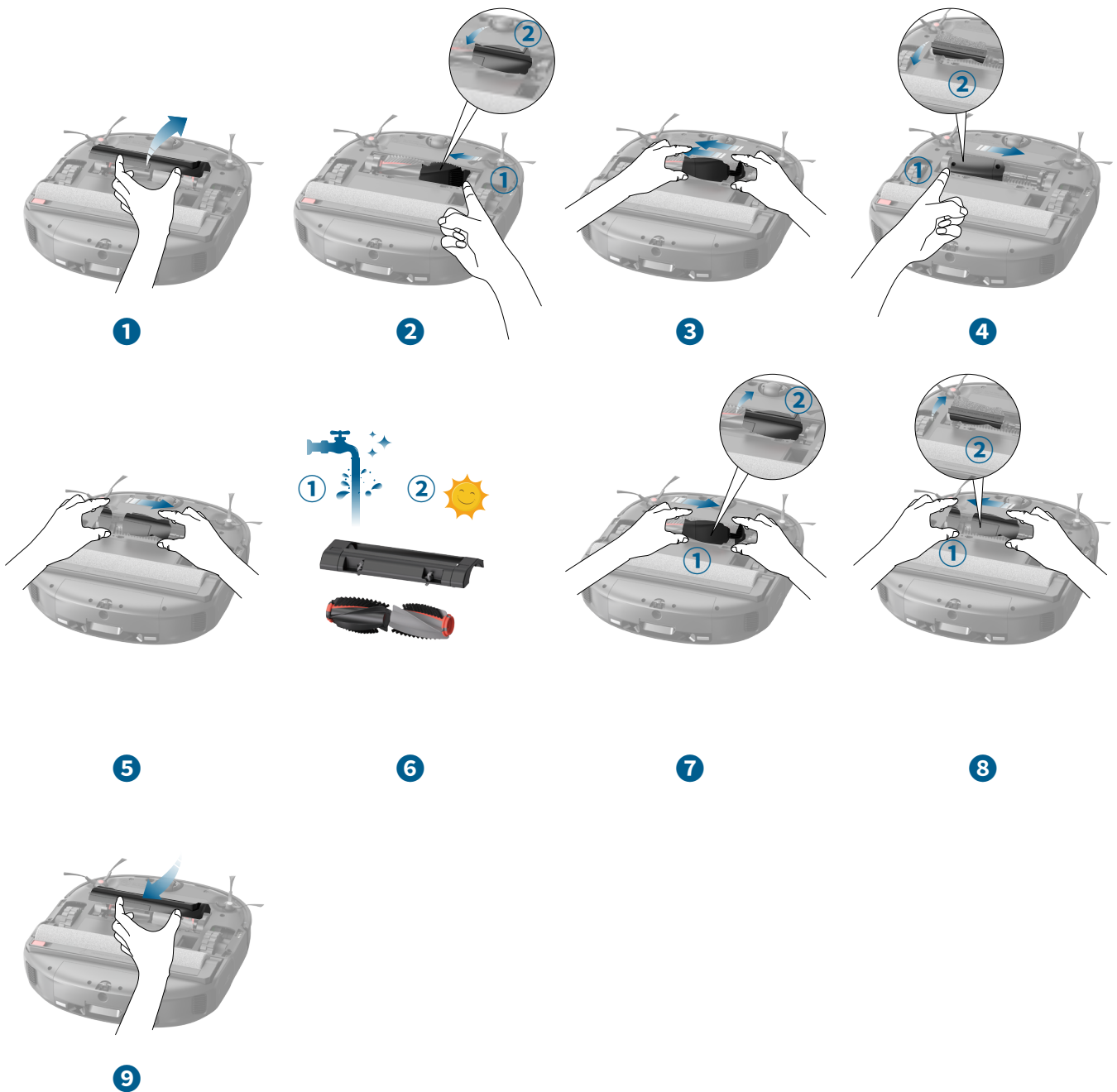

7.6 Clean the Sensors, Cameras, and Charging Pins

To maintain the best performance, clean the sensors and charging contact pins regularly.

- Dust off the sensors and charging contact pins using a soft cloth.



7.7 Clean the Scraper

- 1 Remove the scraper from the RoboVac.
- 2 Detach the filter from the scraper.
- 3 Rinse the filter thoroughly with water, and clean the scraper with a brush.
- 4 Air dry the filter and scraper before next use.
- 5 Reinstall the filter by clicking it into place.
- 6 Reinstall the scraper.

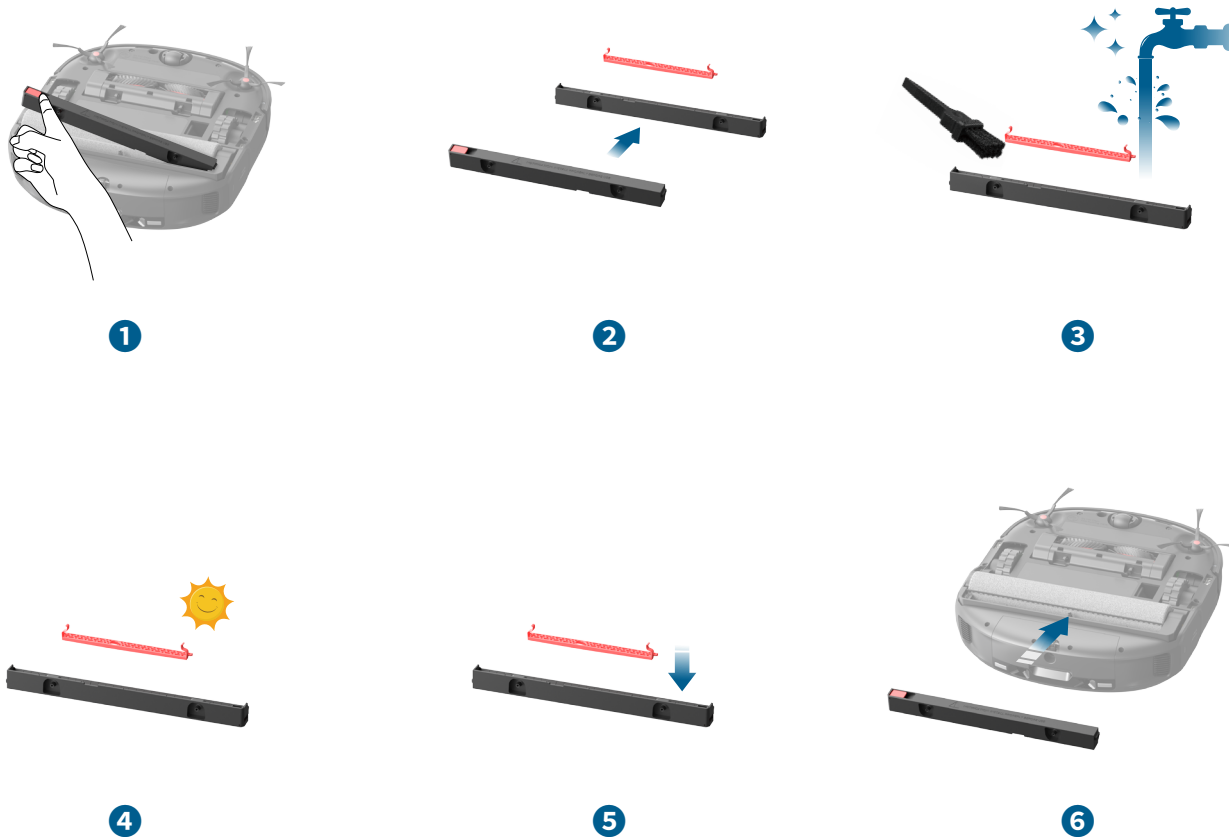

7.8 Clean the Swivel Wheel

- 1 Pry up the swivel wheel with a screwdriver.
- 2 Clean any hair or debris wrapped around the wheel or entangled inside the wheel cavity.
- 3 Reinstall the wheel by pressing it down.

*You will hear two "click" sounds when it is securely in place.

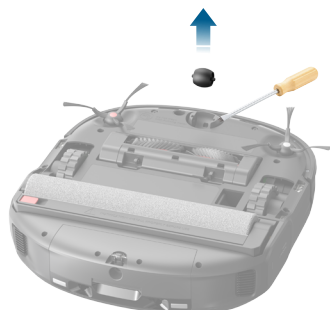

1



2

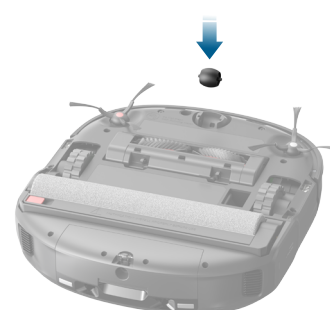

3

7.9 Replace the Dust Bag

- 1 Remove the clean water tank and dirty water tank.
- 2 Open the cover of the dust bag container.
- 3 Install a new dust bag. Ensure the dust bag is fully inserted, then close the cover.



1



2



3

7.10 Clean the Cleaning Tray

- 1 Remove the cleaning tray from the Omni Station.
- 2 Rinse the cleaning tray thoroughly with water, and clean it with a brush.
- 3 Air dry the cleaning tray before next use.
- 4 Gently tilt the cleaning tray inward and align it with the two clips inside.
- 5 Press down firmly on both sides until it clicks into place.

*The LED indicator on the Omni Station will turn from red to white when it is successfully installed.

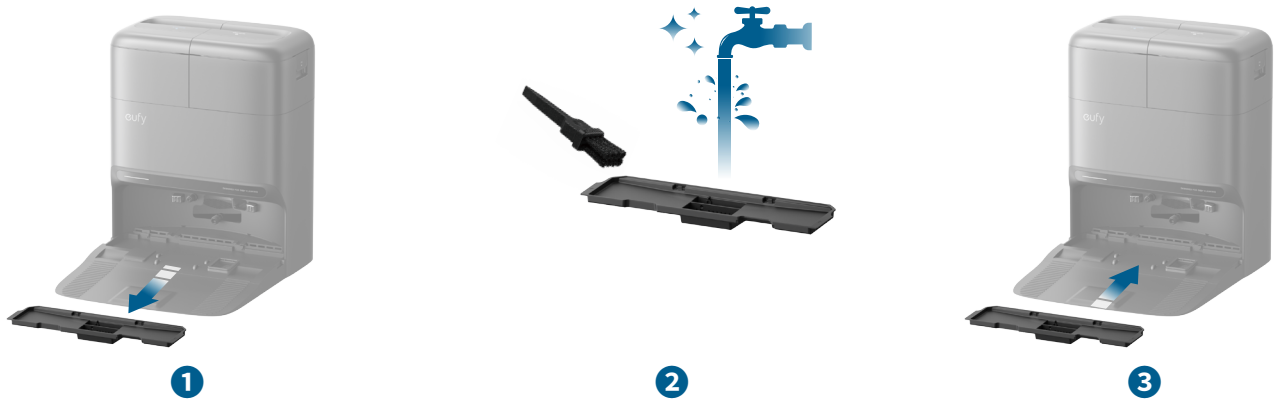

7.11 Clean the Dirty Water Tank

- 1 Remove the dirty water tank from the Omni Station.
 - 2 Open and empty the dirty water tank.
 - 3 Rinse the dirty water tank thoroughly with running water.
 - 4 Close the dirty water tank cover.
- *You will hear a "click" when it is securely in place.
- 5 Reinstall the dirty water water tank on the Omni Station.



1



2



3



4





5

8. Troubleshooting

When an error occurs, please refer to the in-app instructions for solutions. If the problem persists, please contact support@eufy.com for help.

9. Specifications

	Dimensions	349.8*327*110.6 mm
	Weight	11 lbs
	Battery	Li-ion 5200mAh DC14.6V
	Input	20V=1.8A
	Power	Input: 35W Output: 40W
	Cleaning Time	Vacuum Only Mode Quiet Suction: 251 min Standard Suction: 231 min MAX Suction: 187 min Vacuum and Mop Mode Quiet Suction: 139 min Standard Suction: 123 min MAX Suction: 111 min
	Charging Time	3.5h
	Clean Water Reservoir	120ml
	Dirty Water Reservoir	100ml
	Operation Frequency	2.4G Band (2.4000GHz - 2.4835GHz)
	Dimensions	430*352.5*437 mm
	Weight	13.56 lbs
	Voltage	US/JP/KR/CA Version: 100-127V, 50-60Hz; EU/UK/AU/MEA Version: 220-240V, 50-60Hz;
	Power	Dust collection: 650W Dry and charge: 85 W
	Clean Water Tank	2.2L
	Dirty Water Tank	2.2L
	Disposable Dust Bag Capacity	3L

-  The C28 Omni Station features a warm air drying function. When the ambient temperature is above 35 °C, the Robovac will charge first; room-temperature air drying will be used until the Robovac is fully charged.
- As voltages vary across different countries and regions, we recommend purchasing the machine version specific to your location to avoid potential safety hazards and equipment damage.
- Anker Innovations Limited declares that the radio equipment type T211A is in compliance with Directive 2014/53/EU. The full text of the EU declaration of conformity is available at the following website: <https://support.eufy.com/s/articleRecommend?type=Download>

10. Customer Service

Contact Us:



support@eufy.com



www.eufy.com



(US/CA) +1 (800)994 3056

(UK) +44 (0) 1604 936 200

(DE) +49 (0) 69 9579 7960

(JP) +81 03 4455 7823

For video tutorials, FAQs, warranty policies, and more information, please visit <https://support.eufy.com/>

Hereby, Anker Innovations Limited declares that this device is in compliance with The Product Security and Telecommunications Infrastructure (Security Requirements for Relevant Connectable Products) Regulations 2023. For the Statement of Compliance, visit the website: <https://www.eufy.com/uk/psti-related>.

To enter CEC and ERP modes (low power mode), when the robot is in the station, press and hold the recharge button for 14 seconds. The light will flash at a frequency of once per second, indicating it has entered CEC and ERP modes. Press and hold the power button for 2 seconds to exit CEC and ERP modes.

67/UDP:

Port used by the DHCP server to receive configuration requests from clients.

68/UDP:

Port used by the DHCP client to receive configuration information returned by the server (such as IP address, subnet mask, gateway, etc.).

Function:

DHCP uses these two ports to automatically assign IP addresses to network devices, simplifying network management. For example, when a device connects to a network, it sends a broadcast request through port 67, and the server responds and assigns the IP configuration.

Ports 67 and 68 are required for computer network configuration and Internet access and are commonly used in normal business operations.