

## Operating and installation instructions Induction hobs



It is **essential** to read the operating and installation instructions before setup, installation, and commissioning. This prevents both personal injury and damage to the appliance.

# Contents

---

<b>Warnings and safety notes</b> .....	<b>5</b>	Power management.....	38
<b>Sustainability and environmental protection</b> .....	<b>12</b>	Operation .....	38
<b>Installation</b> .....	<b>13</b>	Networking.....	38
Safety notes for installation .....	13	Special functions.....	39
Additional safety notes for surface-mounted installation .....	14	M Sense cookware ready .....	39
Additional safety notes for flush-fit installation.....	14	Controlling a cooker hood .....	39
Safety distances .....	15	Permanent pan recognition.....	39
Installation dimensions for surface-mounted installation .....	23	Pan size recognition .....	39
KM 8765 FL Diamond.....	23	Hob Booster.....	39
KM 8885-2 FL Diamond and M Sense .....	24	Stop&Go.....	39
KM 8895-2 FL Diamond and M Sense .....	25	Hob power levels.....	39
Installation dimensions for flush-fit installation .....	26	Auto heat-up .....	39
KM 8765 FL Diamond.....	26	Timer functions .....	40
KM 8885-2 FL Diamond and M Sense .....	27	Professional mode.....	40
KM 8895-2 FL Diamond and M Sense .....	28	Light line.....	40
Installing a surface-mounted hob ...	29	System lock.....	40
Preparing the worktop for surface-mounted installation .....	29	Keypad lock .....	40
Installing a surface-mounted hob .....	29	Recall.....	40
Installing the hob flush with the worktop .....	29	Keeping warm .....	40
Preparing the worktop for flush-fit installation .....	29	Wipe protection.....	40
Installing a flush-fit hob .....	29	Settings.....	40
Electrical connection .....	30	Demo mode.....	41
<b>Familiarisation</b> .....	<b>33</b>	Demo mode.....	41
Your hob .....	33	Residual heat indicator .....	41
KM 8765 FL Diamond.....	33	Safety switch-off .....	41
KM 8885-2 FL Diamond and M Sense .....	34	Overheating protection.....	42
KM 8895-2 FL Diamond and M Sense .....	35	Model identifier and serial number.....	42
Controls and indicators .....	35	Software version.....	42
		Software update .....	42
		Optional accessories .....	43
		<b>Commissioning</b> .....	<b>44</b>
		Unpacking the hob .....	44
		Cleaning the hob for the first time...	44
		Switching on the hob for the first time .....	44

Networking .....	44	Timer functions.....	51
Requirements for networking with your home network.....	44	Setting the timer.....	51
Using NFC .....	44	Changing the timer.....	52
Performing Scan & Connect.....	45	Deleting the timer.....	52
Requirements for direct net- working with your Miele cooker hood.....	45	Setting the time for a duration ...	52
Networking your hob with your Miele cooker hood.....	45	Setting the duration of a cook- ing process .....	52
Resetting settings.....	45	Changing the duration of a cooking process.....	52
<b>Operation .....</b>	<b>47</b>	Deleting the duration of a cook- ing process .....	52
Safety notes for operation.....	47	Setting a duration for further cooking processes.....	53
Switching the hob on .....	47	Starting elapsed time measure- ment of a cooking process .....	53
Switching the hob/cookware off .....	48	Cancelling elapsed time meas- urement of a cooking process ...	53
Positioning cookware.....	48	Starting elapsed time measure- ment of further cooking pro- cesses .....	53
Hob power levels.....	49	Switching between the power level display and timer function display .....	53
Setting the power level for cookware.....	49	Professional mode .....	53
Setting the power level for cookware – without intermedi- ate levels .....	49	Activating Professional mode .....	53
Changing the power level for cookware.....	49	Changing the power levels for the hob areas in Professional mode .....	54
Booster .....	49	Deactivating Professional mode	54
Activating the Booster .....	49	System lock.....	55
Deactivating the Booster.....	50	Activating the system lock .....	55
Activating/deactivating Stop&Go ..	50	Deactivating the system lock.....	55
Auto heat-up .....	50	Keypad lock.....	55
Activating auto heat-up.....	51	Activating the keypad lock .....	55
Deactivating auto heat-up .....	51	Deactivating the keypad lock.....	55
		Recall .....	56
		Activating the Recall function.....	56
		Discarding the Recall function....	56
		Wipe protection .....	56
		Activating wipe protection .....	56
		Deactivating wipe protection.....	56

# Contents

---

Using M Sense cookware .....	56	Warranty .....	77
M Sense cookware: activating special functions on the hob .....	56	<b>Technical data</b> .....	<b>78</b>
M Sense cookware: deactivating special functions on the hob .....	56	Technical data .....	78
Ending assistance from M Sense cookware .....	56	Product data sheets .....	78
Hob data .....	56	EU Conformity declaration .....	79
Displaying the model identifier/serial number .....	56	UK Conformity declaration .....	80
Displaying the software version .....	57		
Activating/deactivating demo mode .....	57		
Activating/deactivating demo mode .....	58		
<b>Setting ranges for the hob power levels</b> .....	<b>59</b>		
Notes for test institutes .....	60		
<b>Good to know</b> .....	<b>61</b>		
How induction hobs work .....	61		
Noises .....	61		
Cookware .....	61		
<b>Adjusting settings</b> .....	<b>63</b>		
Displaying the model identifier/serial number .....	69		
Displaying the software version .....	69		
Software update .....	69		
<b>Cleaning and care</b> .....	<b>71</b>		
Safety notes on cleaning and care ..	71		
Cleaning the ceramic glass surfaces .....	71		
Unsuitable cleaning agents .....	71		
<b>Troubleshooting</b> .....	<b>72</b>		
Messages in the display .....	72		
Unexpected behaviour .....	73		
Unsatisfactory results .....	75		
General problems or technical faults .....	76		
<b>Customer Service</b> .....	<b>77</b>		
Contact in the event of a fault .....	77		
Data plate .....	77		

This hob complies with all relevant local and national safety requirements. Inappropriate use can, however, lead to personal injury and material damage.

Read the operating and installation instructions carefully before using the hob. They contain important information on safety, installation, use and maintenance. This prevents both personal injury and damage to the hob.

In accordance with standard IEC 60335-1, Miele expressly and strongly advises that you read and follow the instructions in the chapter on installing the hob as well as the warnings and safety notes.

Miele cannot be held liable for injury or damage caused by non-compliance with these instructions.

Keep the operating and installation instructions in a safe place and pass them on to any future owner.

### Correct application

- ▶ This hob is intended for domestic use and use in other similar environments.
- ▶ This hob is not intended for outdoor use.
- ▶ It is intended for domestic use only to cook food and keep it warm. Any other use is not supported by the manufacturer and could be dangerous.
- ▶ This hob is not intended for use by people with reduced physical, sensory or mental capabilities or lack of experience and knowledge, unless they have been given supervision and instruction concerning its use by a person responsible for their safety. They may only use the hob unsupervised if they have been shown how to use it in a safe way. They must be able to recognise and understand the dangers of misuse.

### Safety with children

- ▶ Children under 8 years of age must be kept away from the hob unless they are constantly supervised.

## Warnings and safety notes

---

- ▶ Children over 8 years of age may use the hob without supervision if its operation has been clearly explained to them and they are able to use it safely. Children must be able to understand and recognise the possible dangers caused by incorrect operation.
- ▶ Children must not be allowed to clean the hob unsupervised.
- ▶ Children should be supervised in the vicinity of the hob. Never allow children to play with the hob.
- ▶ The hob gets hot when in use and remains hot for a while after being switched off. Keep children well away from the hob until it has cooled down and there is no danger of burning.
- ▶ Danger of burning. Do not store anything which might arouse a child's interest in storage areas above or behind the hob. Otherwise they could be tempted to climb onto the hob.
- ▶ Risk of burning and scalding. Place pots and pans on the cooking zone in such a way that children cannot pull them down and burn themselves.
- ▶ Danger of suffocation! Whilst playing, children may become entangled in packaging material (such as plastic wrapping) or pull it over their head with the risk of suffocation. Keep packaging material away from children.
- ▶ Activate the system lock to ensure that children cannot switch on the hob inadvertently. Use the keypad lock when the hob is in use to prevent children from altering the settings selected.

### Technical safety

- ▶ Unauthorised installation, maintenance and repairs can pose a considerable risk to the user. Installation, maintenance and repairs must only be carried out by a Miele authorised technician.
- ▶ Damage to the hob can compromise your safety. Check the hob for visible signs of damage. Do not use the hob if it is damaged.

## Warnings and safety notes

---

▶ Temporary or permanent operation on an autonomous power supply system or a power supply system that is not synchronised with the mains power supply (e.g. island networks, back-up systems) is possible. A prerequisite for operation is that the power supply system complies with the specifications of EN 50160 or an equivalent standard.

The function and operation of the protective measures provided in the domestic electrical installation and in this Miele product must also be maintained in isolated operation or in operation that is not synchronised with the mains power supply, or these measures must be replaced by equivalent measures in the installation. As described, for example, in the current version of BS OHSAS 18001–2 ISO 45001.

▶ The electrical safety of this hob can only be guaranteed when correctly earthed. It is essential that this basic safety requirement is fulfilled. If in doubt, the electrical installation should be checked by a qualified electrician.

▶ The connection data (voltage and frequency) on the data plate of the hob must match the mains power supply in order to avoid the risk of damage to the hob.

Compare this data before connecting the appliance. If in any doubt, consult a qualified electrician.

▶ Do not connect the hob to the mains electrical supply by a multi-socket adapter or extension lead. These are a fire hazard and do not guarantee the required safety of the appliance.

▶ For safety reasons, this hob may only be used after it has been built in.

▶ This hob must not be used in a non-stationary location (e.g. on a ship).

▶ Any contact with live connections or tampering with the electrical or mechanical components of the hob will endanger your safety and may lead to the hob malfunctioning.

Do not open the hob housing under any circumstances.

▶ While the hob is under warranty, repairs should only be undertaken by a Miele authorised service technician. Otherwise the warranty is invalidated.

▶ Miele can only guarantee the safety of the appliance when genuine original Miele replacement parts are used. Faulty components must only be replaced by Miele spare parts.

## Warnings and safety notes

---

- ▶ The hob is not intended for use with an external timer switch or a remote control system.
- ▶ The hob must be connected to the mains power supply by a qualified electrician.
- ▶ If the mains connection cable is damaged, it must be replaced with a special mains connection cable by a qualified electrician.
- ▶ During installation, maintenance and repair work, the hob must be completely disconnected from the electricity supply. It is only completely isolated from the electricity supply when:
  - The mains fuse has been disconnected or
  - The screw-out fuses have been fully unscrewed or
  - The mains plug (if present) is removed from the socket. To do this, pull the mains plug and not the mains connection cable.
- ▶ Risk of electric shock. Do not use the hob if it is faulty, or if the ceramic surface is cracked, chipped or damaged in any way. Switch it off immediately. Disconnect the hob from the mains electricity supply. Contact the Customer Service Department.
- ▶ If the hob is installed behind a furniture front, do not close the door while the hob is in use. Heat and moisture can build up behind the furniture front when closed. This can result in damage to the hob, the housing unit and the floor. Do not close the furniture front until the residual heat indicators go out.
- ▶ In areas which may be subject to infestation by cockroaches or other vermin, pay particular attention to keeping the appliance and its surroundings clean at all times. Any damage caused by cockroaches or other vermin will not be covered by the warranty.

### Correct use

- ▶ The hob gets hot when in use and remains hot for quite a while after being switched off. There is a risk of burning until the residual heat indicators go out.
- ▶ Oil and fat can overheat and catch fire. Do not leave the hob unattended when cooking with oil and fat. If it does ignite do not attempt to put the flames out with water. Disconnect the hob from the mains and use a suitable fire blanket, saucepan lid, damp towel or similar to smother the flames.
- ▶ Do not leave the hob unattended whilst it is being used. It should be continually monitored whilst boiling and flash frying.

## Warnings and safety notes

---

- ▶ Flames could set the grease filters of a cooker hood on fire. Do not flambé under a cooker hood.
- ▶ Spray canisters, aerosols and other inflammable substances can ignite when heated. Therefore do not store such items or substances in a drawer under the hob. Cutlery inserts must be heat-resistant.
- ▶ Do not heat an empty pan.
- ▶ Do not heat up food in closed containers e.g. tins or sealed jars on the hob, as pressure can build up in the container, causing it to explode.
- ▶ Do not cover the hob, e.g. with a hob cover, a cloth or protective foil. The material could catch fire, shatter or melt if the hob is switched on by mistake or if residual heat is still present.
- ▶ When the appliance is switched on either deliberately or by mistake, or when there is residual heat present, there is the risk of metal items placed on the hob heating up. Other materials can melt or catch fire. Damp pan lids might adhere to the ceramic surface and be difficult to dislodge. Do not use the hob as a resting place for anything. Switch the hob off after use.
- ▶ Switch the hob off after use. Do not wait until the hob switches off automatically because there is no longer any cookware on it. This can cause food to catch fire.
- ▶ You could burn yourself on the hot hob. Protect your hands with heat-resistant pot holders or gloves when working on the hot hob. Do not let them get wet or damp. Heat transfers through damp and wet material more quickly with the risk of scalding or burning yourself.
- ▶ When using an electrical appliance (e.g. a hand mixer) near the hob, ensure that the cable of the electrical appliance cannot come into contact with the hot hob. The cable's insulation could become damaged.
- ▶ Grains of salt, sugar, or sand (e.g. from cleaning vegetables) can cause scratches if they get under the cookware. Make sure the ceramic glass surface and the underside of the cookware are clean before placing down the cookware.
- ▶ Even a light object can cause damage in certain circumstances. Do not drop anything on the ceramic surface.
- ▶ Hot items placed down on the sensor controls and displays can damage the electronic modules underneath. Never place hot pots or pans on the sensor controls and displays.

## Warnings and safety notes

---

- ▶ Do not allow solid or liquid sugar, or pieces of plastic or aluminium foil to get onto the hob when it is hot, as they can damage the ceramic surface when it cools down. If this should occur, turn off the hob immediately and scrape off all the sugar, plastic or aluminium residues while still hot, using a shielded scraper blade. Wear oven gloves when doing this. Allow the ceramic surface to cool down and then clean it with a suitable ceramic glass cleaner.
- ▶ Do not heat empty pans on the hob as this can damage the ceramic glass and/or the cookware. Never leave the hob unattended during use!
- ▶ Rough bases can scratch the ceramic glass. Use only pots and pans with smooth bases.
- ▶ Always lift cookware to move it. This will help prevent scratching.
- ▶ Because induction heating works so quickly, the base of the cookware could, under certain circumstances, heat up to the temperature at which oil or fat self-ignites within a very short time. Never leave the hob unattended during use!
- ▶ Heat oil or fat for a maximum of one minute. Never use the Booster function to heat oil or fat.
- ▶ For people fitted with a heart pacemaker: please note that the area immediately surrounding the hob is electromagnetically charged when it is switched on. It is very unlikely to affect a pacemaker. However, if in any doubt, consult the manufacturer of the pacemaker or your doctor.
- ▶ When switched on, the electromagnetic field of the hob can impair the function of magnetisable objects. Do not leave credit cards, digital storage devices, pocket calculators, etc. in the immediate vicinity of the hob.
- ▶ Metal utensils stored in a drawer under the hob can become hot if the appliance is used intensively for a long time.
- ▶ The hob is fitted with a cooling fan. If a drawer is fitted directly underneath the hob, ensure that there is sufficient space between the drawer and its contents and the underside of the hob in order to ensure sufficient ventilation for the hob.
- ▶ If a drawer is fitted directly underneath the hob, do not store any pointed or small items, paper, serviettes, etc. in the drawer. They could get in through the ventilation slots or be sucked into the casing by the fan and damage the fan or impair cooling.

▶ The induction generators could be damaged or even destroyed if you use an induction adapter plate for cookware. Do not use induction adapter plates.

### **Cleaning and care**

▶ The steam from a steam cleaner could reach live electrical components and cause a short circuit.

Do not use a steam cleaner to clean the hob.

▶ If the hob is installed above a pyrolytic oven or cooker, do not use the hob during a pyrolytic cleaning programme as this could trigger the overheating protection mechanism on the hob.

▶ Miele will guarantee to supply functional spare parts for a minimum of 10 years and up to 15 years following the discontinuation of your hob.

# Sustainability and environmental protection

---

## Energy saving tips when cooking

- Cook in covered pots and pans if possible. This prevents heat escaping unnecessarily.
- Cook with as little water as possible.
- Once food has come to the boil or the pan is hot for frying, reduce the heat to a lower power level.
- Use a pressure cooker to reduce cooking durations.

## Disposing of the packaging material

The packaging material is used for handling and protects the appliance from transport damage. The packaging material used is selected from materials which are environmentally friendly for disposal and can generally be recycled.

Recycling the packaging material reduces the use of raw materials. Use material-specific collection points for valuable materials and take advantage of return options. Your Miele dealer will take the packaging material away.

## Disposing of your old appliance

Electrical and electronic appliances contain many valuable materials. They also contain certain materials, compounds and components which were essential for their correct functioning and safety. These could be hazardous to human health and to the environment if disposed of with household waste or if handled incorrectly. Please do not, therefore, dispose of your old appliance with household waste.

Instead, please make use of officially designated collection and disposal points to dispose of and recycle electrical and electronic appliances in your local community, with your dealer or with Miele, free of charge. By law, you are solely responsible for deleting any personal data from the old appliance prior to disposal. You are legally obliged to remove any old batteries which are not securely enclosed by the appliance and to remove any lamps without destroying them, where this is possible. These must be taken to a suitable collection point where they can be handed in free of charge. Please ensure that your old appliance poses no risk to children while being stored for disposal.



## Safety notes for installation

 Risk of damage from incorrect installation.

Incorrect installation can cause damage to the hob.

The hob must only be installed by a qualified specialist.

 Risk of electric shock from mains voltage.

Incorrect connection to the mains supply may result in an electric shock.

The hob must be connected to the electrical supply by a qualified electrician only.

 Damage from falling objects.

Take care not to damage the hob when fitting wall units or a cooker hood above it.

Fit the wall units and the cooker hood before the hob.

Dismantling the hob for service purposes may damage the sealing strip underneath the edge of the hob.

Always replace the sealing strip before reinstalling.

► The hob must not be installed over refrigeration appliances, dishwashers, washing machines, washer-dryers or tumble dryers.

► This hob may only be installed above a cooker or oven if they have a built-in cooling fan.

► Ensure that the mains connection cable cannot be touched after the hob has been installed.

► After installation, the mains connection cable of the hob must not come into contact with any moving kitchen components (such as a drawer) or be subject to mechanical loads.

► The veneers or laminate coatings of worktops must be treated with 100 °C heat-resistant adhesive so they do not come loose or warp. Any wall strips must be of heat-resistant material.

► The installation of Diamond-Finish models in front of a window is not recommended. Direct sunlight causes the surface to reflect more intensely and makes the displays harder to see.

► Remember to maintain the minimum safety distances.

# Installation

## Additional safety notes for surface-mounted installation

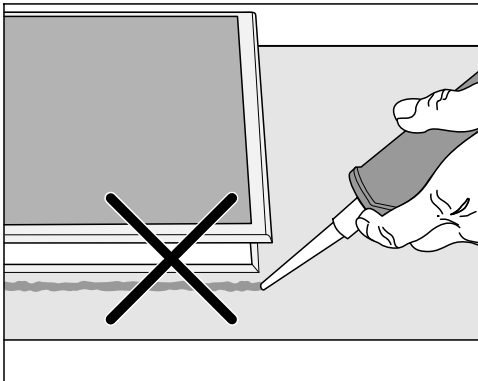

⚠ Damage caused by incorrect installation.

Using sealant under the hob could result in damage to the hob and the worktop if the hob ever needs to be removed.

Do not use sealant between the hob and the worktop. The sealing strip under the edge of the hob provides a sufficient seal for the worktop.

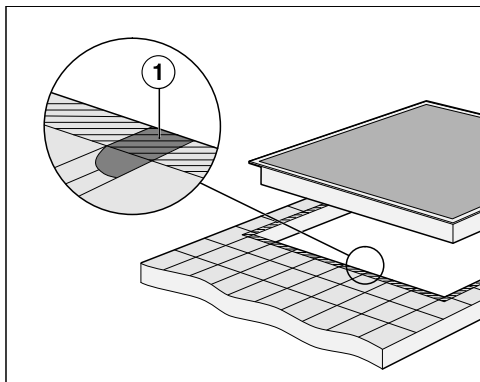

► Grout lines ① and the hatched area underneath the hob frame must be smooth and even. If they are not, the hob will not sit flush with the worktop and the sealing strip underneath the hob will not provide a good seal between the hob and the worktop.

## Additional safety notes for flush-fit installation

⚠ Damage caused by using an unsuitable sealant.

Unsuitable sealant can damage natural stone.

For natural stone worktops and natural stone tiles, only use silicone sealant that is temperature-resistant (min. 160 °C) and specially formulated for natural stone. Follow the manufacturer's instructions.

► The internal width of the base unit underneath the appliance must be at least as wide as the inner worktop cut-out so that the hob is easily accessible from below after installation and the casing can be removed for maintenance. If the underside of the hob is not freely accessible after installation, any sealant must be removed to enable the hob to be lifted out.

► A flush-fit hob is suitable only for installation in natural stone (granite, marble), solid wood and tiled worktops. When using a worktop made from any other material, please check first with the worktop manufacturer that the material is suitable for installing a flush-fit hob.

- Natural stone worktops: the hob is set directly in the cut-out.
- Solid wood worktops, tiled worktops: the hob is secured inside the cut-out with wooden battens. The battens must be provided on site and are not included in the scope of delivery.

The following must be ensured between the hob and the cooker hood above it:

- The safety distance specified by the manufacturer of the cooker hood must be maintained.
- When two or more appliances which have different safety distances are installed together below a cooker hood, the greatest specified safety distance must be maintained.

If combustible objects are installed above the hob (e.g. cabinets, utensil rail, etc.), a minimum safety distance of 500 mm must be maintained.

## Safety distances

### Safety distance above the hob

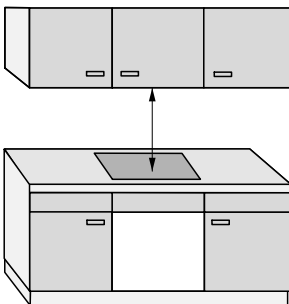

# Installation

## Safety distance behind and to the side of the hob

The minimum safety distances shown below must be maintained between the appliance and a tall unit or wall:

- Between the **back** ① of the worktop cut-out and the rear edge of the worktop:  
50 mm  
and
- On the **right side** ② between the worktop cut-out and the closest adjacent piece of furniture (e.g. tall unit) or a room wall:  
50 mm and on the opposite side a minimum safety distance of 200 mm  
or
- On the **left side** ③ between the worktop cut-out and the closest adjacent piece of furniture (e.g. tall unit) or a room wall:  
50 mm and on the opposite side a minimum safety distance of 200 mm

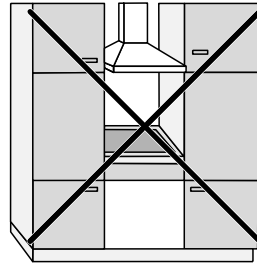

Not permitted

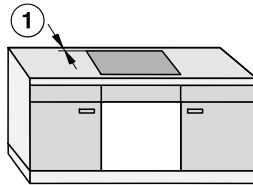
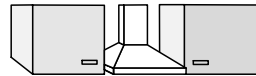

Highly recommended

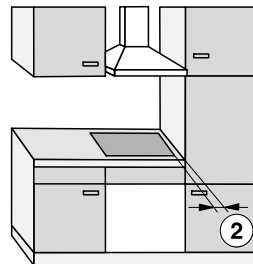

Not recommended

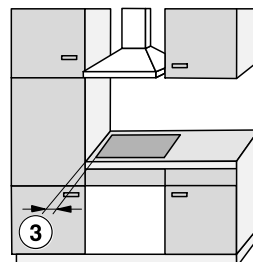

Not recommended

## Safety distance underneath the hob

To install the hob while maintaining the safety distances, you can choose from 3 variants:

1. Without intermediate shelf or base panel
2. With intermediate shelf
3. With an air intake-optimised base panel

Further instructions are described in the relevant section.



An air intake-optimised base panel and an intermediate shelf cannot be combined.

If they are combined, more warm air is drawn in. The hob is not adequately cooled.

The hob is ventilated from below. A drawer underneath the hob is heated.

If you wish to install a drawer underneath the hob, we recommend installing the hob with an air intake-optimised base panel to reduce the waste heat from the hob.

## Rear panel cut-out

For ventilation and **accommodating the mains connection cable**, you will need to create a cut-out in the rear panel.

Create a cut-out in the rear panel using the following instructions:

# Installation

## 1. Without intermediate shelf or base panel

To ensure sufficient ventilation to the hob, a minimum safety distance must be left between the underside of the hob and any drawer or oven.

The minimum safety distance between the underside<sup>1</sup> of the hob and:

- Upper edge of drawer: KM 8xxx:  $\geq 5$  mm, KM 8xxx-2:  $\geq 8$  mm
- Base of drawer:  $\geq 75$  mm
- Upper edge of oven: KM 8xxx:  $\geq 2$  mm, KM 8xxx-2:  $\geq 8$  mm

<sup>1</sup> The underside is the outside of the hob casing. Other items that are attached lower down, such as connection boxes and shims, do not count as the lowest point and are not relevant when calculating the minimum safety distance.

## 2. Intermediate shelf

The dimensions shown in brackets are recommendations.

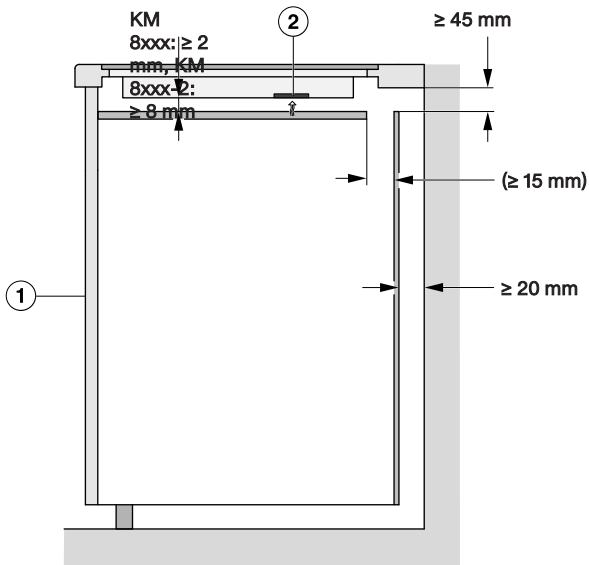

Side view

① Front

② Fan

## 3. Air intake-optimised base panel

The performance of the hob depends on the ventilation.

The air intake-optimised base panel has openings where the fans are positioned. This section contains instructions for creating an air intake-optimised base panel.

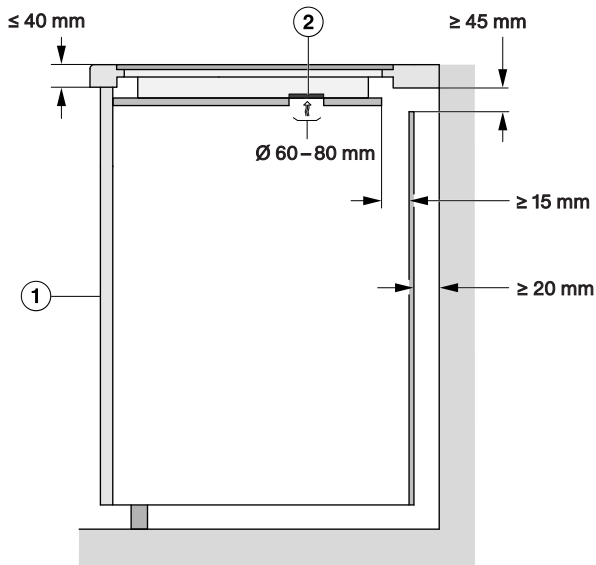

Side view

- ① Front
- ② Fan

To ensure sufficient ventilation to the hob, a minimum safety distance must be left between the underside of the air intake-optimised base panel and any drawer.

Minimum safety distance between the **underside of the air intake-optimised base panel** to the:

- Upper edge of drawer: KM 8xxx:  $\geq 5$  mm, KM 8xxx-2:  $\geq 8$  mm
- Base of drawer:  $\geq 75$  mm
- Upper edge of intermediate shelf: not permitted

There must be no gap between the air intake-optimised base panel and the hob. A gap causes more warm air to be drawn in. The hob is not adequately cooled.

# Installation

## Positions and cut-outs of the ventilation openings: KM 8765 FL Diamond

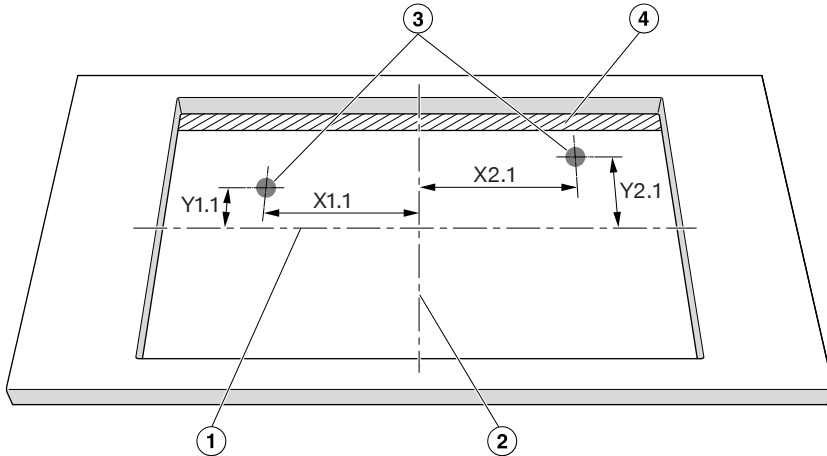

Not to scale. View from above. Surface-mounted cut-out shown. Also applies to flush-fit installation.

- ① Middle of the cut-out height
- ② Middle of the cut-out width
- ③ Cut-out for fan, round (Ø 60–80 mm)
- ④ Gap ( $\geq 15$  mm)

	X1.1	Y1.1	X2.1	Y2.1
	Distance from the middle of the cut-out in mm			
KM 8765 FR/FL	78	133	210	133

Position the hob so that the fans are above the cut-outs.

If the fans are not positioned above the cut-outs, the air flow may be obstructed. The hob is not adequately cooled.

## Positions and cut-outs of the ventilation openings: KM 8885 FL Diamond&MSense, KM 8895 Diamond&MSense

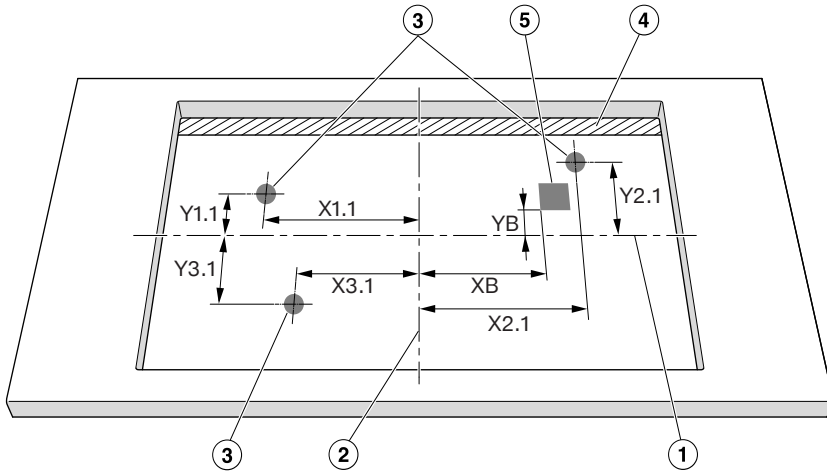

Not to scale. View from above. Surface-mounted cut-out shown. Also applies to flush-fit installation.

- ① Middle of the cut-out height
- ② Middle of the cut-out width
- ③ Cut-out for fan, round ( $\varnothing$  60–80 mm)
- ④ Gap ( $\geq$  15 mm)

	X1.1	Y1.1	X2.1	Y2.1	X3.1	Y3.1
	Distance from the middle of the cut-out in mm					
KM 8885-2 FL Diamond and M Sense	183	133	66	133	315	133
KM 8895-2 FL Diamond and M Sense	221	133	66	133	353	133

Position the hob so that the fans are above the cut-outs.  
If the fans are not positioned above the cut-outs, the air flow may be obstructed.  
The hob is not adequately cooled.

### Minimum safety distance from the niche cladding

If niche cladding is installed, a minimum safety distance must be maintained between the worktop cut-out and the cladding. High temperatures can alter or damage these materials.

# Installation

## Flush-fit installation

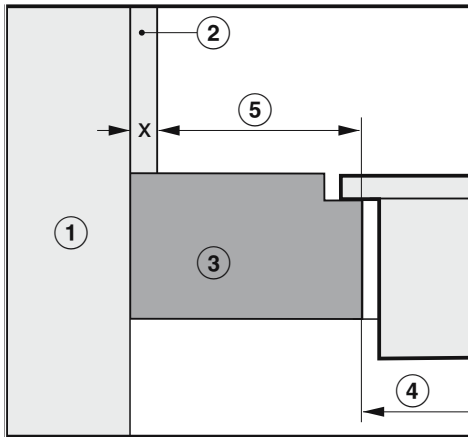

## Surface-mounted installation

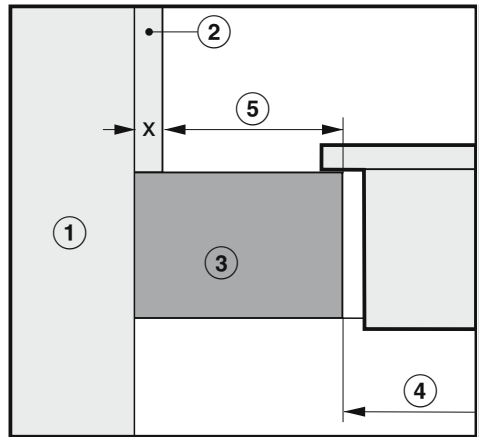

- ① Masonry
- ② Dimension  $x$  = thickness of the niche cladding material
- ③ Worktop
- ④ Worktop cut-out
- ⑤ Minimum safety distance to  
**combustible** materials (e.g. wood)  
**non-combustible** materials (e.g. metal, natural stone, ceramic tiles)

Material	Side		Opposite side	
	Combustible	Non-combustible	Combustible	Non-combustible
Back	50 mm	50 mm – dimension $x$	–	–
Right	50 mm	50 mm – dimension $x$	200 mm	200 mm – dimension $x$
Left	50 mm	50 mm – dimension $x$	200 mm	200 mm – dimension $x$

Example: 15 mm thick non-combustible niche cladding  
 50 mm minus 15 mm = minimum safety distance of 35 mm

## Installation dimensions for surface-mounted installation

### KM 8765 FL Diamond

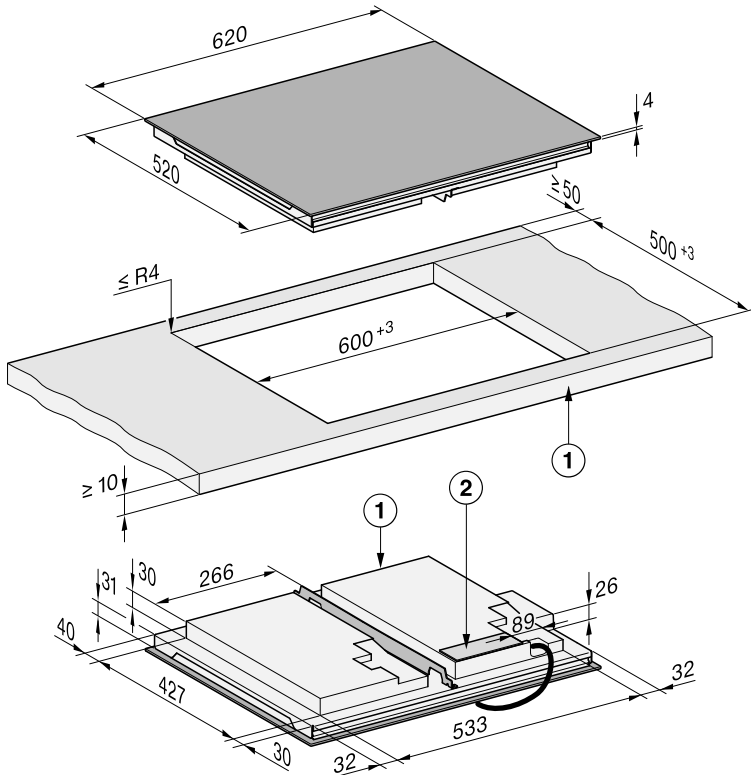

All dimensions are given in mm.

① Front

② Mains connection box

The mains connection cable (L = 1440 mm) is supplied loose

# Installation

## KM 8885-2 FL Diamond and M Sense

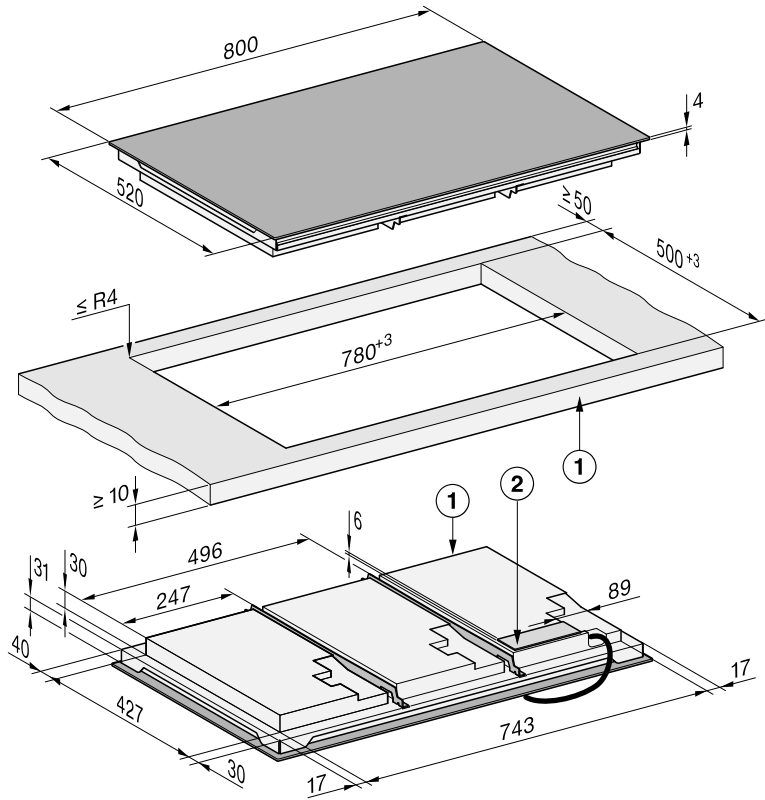

All dimensions are given in mm.

① Front

② Mains connection box

The mains connection cable (L = 1440 mm) is supplied loose

## KM 8895-2 FL Diamond and M Sense

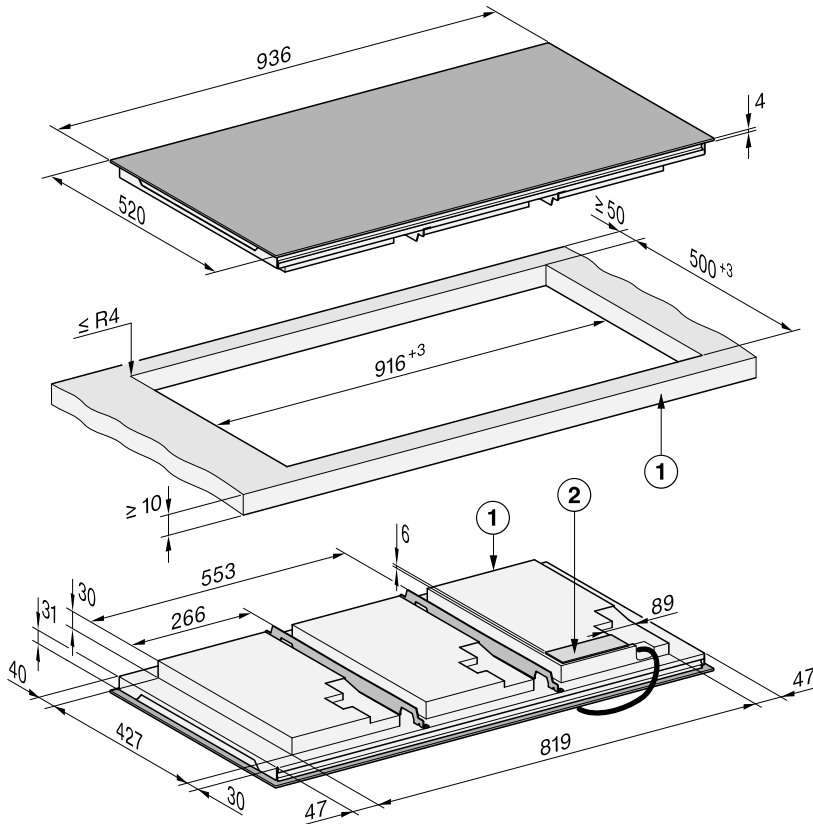

All dimensions are given in mm.

① Front

② Mains connection box

The mains connection cable (L = 1440 mm) is supplied loose



## KM 8885-2 FL Diamond and M Sense

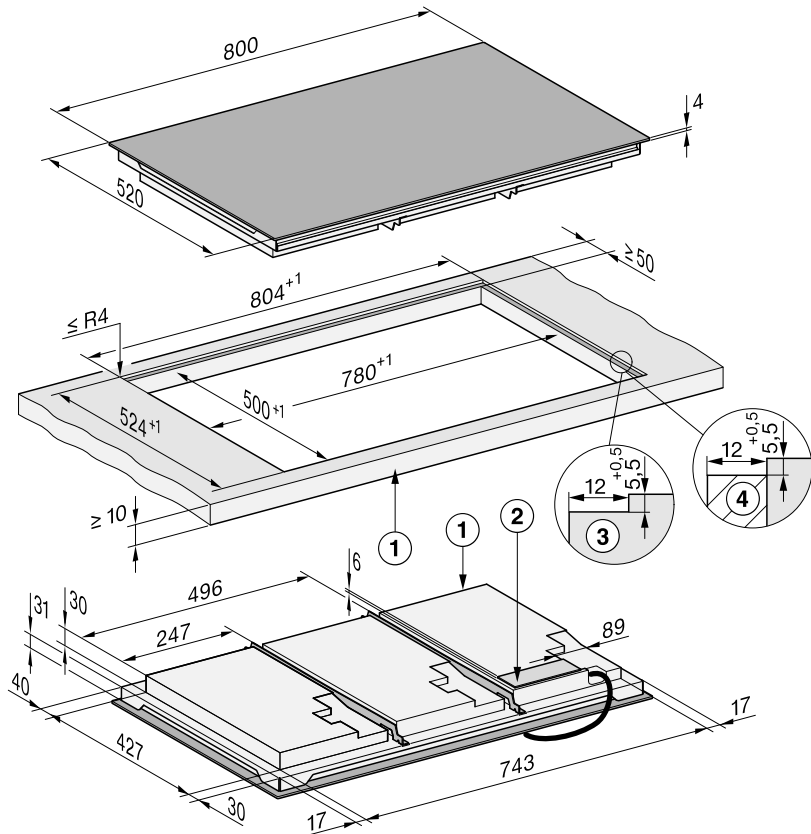

All dimensions are given in mm.

- ① Front
- ② Mains connection box  
The mains connection cable (L = 1440 mm) is supplied loose
- ③ Stepped cut-out, natural stone worktop
- ④ Wooden batten 12 mm (accessories not included)



## Installing a surface-mounted hob

### Preparing the worktop for surface-mounted installation

- Remember to maintain the minimum safety distances.
- Create the worktop cut-out.
- Wooden worktops:  
Seal any cut surfaces with a special varnish, silicone sealant or resin to prevent the wood from swelling as a result of moisture ingress. The sealant must be heat-resistant.

Make sure that the sealant does not come into contact with the top of the worktop.

### Installing a surface-mounted hob

The seal ensures that the hob will sit securely in the cut-out without slipping. Any gap between the appliance frame and worktop will become smaller over time.

- Attach the sealing strip included in the scope of delivery underneath the edge of the hob. The joint edge (start and end) of the sealing strip must not be in a corner. Apply some silicone joint sealant to the joint edge of the sealing strip. Do not apply the sealing strip under tension.

 Risk of damage from incorrect connection.

The hob electronic module may be damaged if a short-circuit occurs. The mains connection cable must be connected to the hob by a qualified electrician.

- Follow the instructions in the wiring diagram to connect the mains connection cable to the hob.
- Feed the mains connection cable for the hob down through the worktop cut-out.
- Place the hob centrally in the cut-out. When doing this, make sure that the seal of the appliance sits flush with the worktop on all sides. This is important to ensure effective sealing all round.
- If the seal does not sit flush with the worktop in the corners, the corner radius ( $\leq R4$ ) can be carefully cut to fit using a jigsaw.
- If an air intake-optimised base panel is installed, position the hob so that the fans are located above the cut-outs.
- Connect the hob to the electricity supply.
- Check that the hob is working.

## Installing the hob flush with the worktop

### Preparing the worktop for flush-fit installation

- Remember to maintain the minimum safety distances.
- Create the worktop cut-out.
- Solid wood and tiled worktops:  
Secure the wooden frame 5,5 mm below the top edge of the worktop.

### Installing a flush-fit hob

The seal ensures that the hob will sit securely in the cut-out without slipping. Any gap between the appliance frame and worktop will become smaller over time.

# Installation

- Attach the sealing strip included in the scope of delivery underneath the edge of the hob. The joint edge (start and end) of the sealing strip must not be in a corner. Apply some silicone joint sealant to the joint edge of the sealing strip. Do not apply the sealing strip under tension.

 Risk of damage from incorrect connection.

The hob electronic module may be damaged if a short-circuit occurs. The mains connection cable must be connected to the hob by a qualified electrician.

- Follow the instructions in the wiring diagram to connect the mains connection cable to the hob.
- Feed the mains connection cable for the hob down through the worktop cut-out.

The gap between the ceramic surface and the worktop must be at least 2 mm wide.

This is required so that the hob can be sealed.

- Centre the hob in the cut-out.
- If an air intake-optimised base panel is installed, position the hob so that the fans are located above the cut-outs.
- Connect the hob to the mains power supply.
- Check that the hob is working.
- Seal the gap between the hob and worktop with a suitable silicone sealant that is heat-resistant to at least 160 °C.

## Electrical connection

 Risk of damage from incorrect connection.

Unauthorised installation, maintenance and repairs can cause considerable danger for the user.

Miele cannot be held liable for damage or injury caused by unauthorised installation, maintenance or repair work, or by an inadequate or faulty on-site earthing system (e.g. electric shock).

This hob must be connected to the mains power supply by a qualified electrician.

The qualified electrician must be familiar with and comply with the national regulations and any additional regulations of the local electricity provider.

After installation, ensure that all electrical components are shielded and cannot be accessed by users.

## Total power rating

See data plate

## Connection data

The connection data is quoted on the data plate. Please ensure these match the household mains supply.

Please see wiring diagrams for connection. (N.B. This appliance is supplied single phase only in the UK / AUS / NZ).

## Residual current device

For extra safety, it is advisable to protect the hob with a suitable residual current device (RCD) with a trip range of 30 mA.

## Disconnecting devices

It must be possible to disconnect the hob from the mains at all poles using disconnecting devices. A contact distance of at least 3 mm must be observed in the switched-off state. The disconnecting devices include overcurrent protection devices and residual current protection devices.

## Disconnecting from the mains

 Risk of electric shock from mains voltage.

There is a risk of electric shock if the appliance is reconnected to the mains voltage supply during repair or service work.

After disconnection, ensure the appliance cannot be switched back on by mistake.

To disconnect the appliance from the mains power supply, do one of the following depending on installation:

### Fine-wire fuses

- Completely remove the fuse links from the screw caps.

### Automatic circuit breakers

- Press the test button (red) until the middle button (black) springs out.

### Built-in circuit breakers

- For circuit breakers of at least type B or C, switch the lever from 1 (on) to 0 (off).

### Residual current device

- Residual current device: switch the main switch from 1 (on) to 0 (off) or press the test button.

## Mains connection cable

The hob must be connected to the electrical supply with a special connection cable, type H 05 VV-F (PVC insulated) with a suitable diameter.

Please see wiring diagrams for connection.

See the data plate on the hob for the correct voltage and rated load.

## Replacing the mains connection cable

 Risk of electric shock.

Incorrect connection to the power supply may result in an electric shock.

The mains cable must only be replaced by a qualified electrician.

When replacing the mains cable only use cable type H 05 VV-F (PVC insulated) with a suitable cross section. A suitable connection cable is available to order from Miele.

## Wiring diagram

Some connection methods are not permitted in all installation locations.

Ensure compliance with national regulations and any additional regulations issued by the local electricity provider.

The maximum load per connected live conductor is 3650 W.

### Hob with < 5 items of cookware ( $\leq 7400$ W)

The first and second live conductors are required for connecting the hob. Further appliances can be connected to the third live conductor.

# Installation

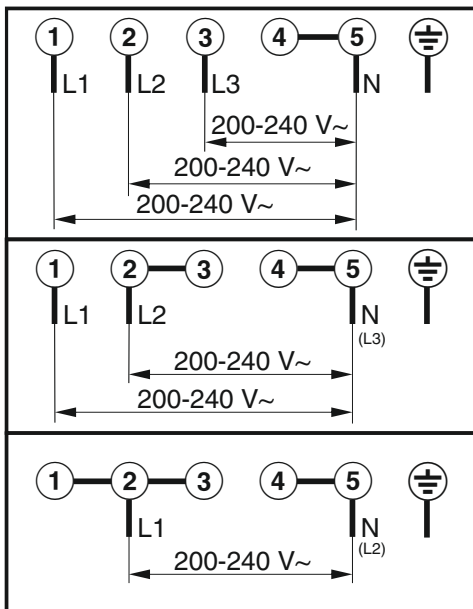

## Hob with $\geq 5$ items of cookware ( $> 7400\text{ W}$ )

All 3 live conductors are required for connecting the hob. No further appliances can be connected to the live conductors.

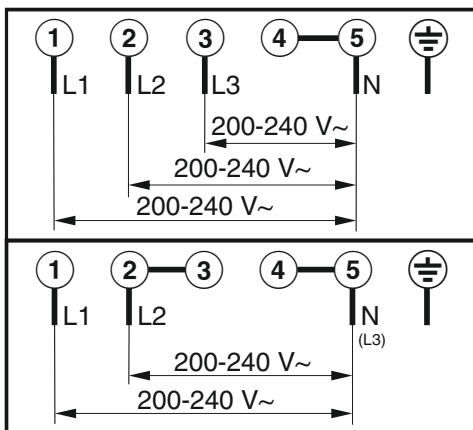

## Your hob

### KM 8765 FL Diamond

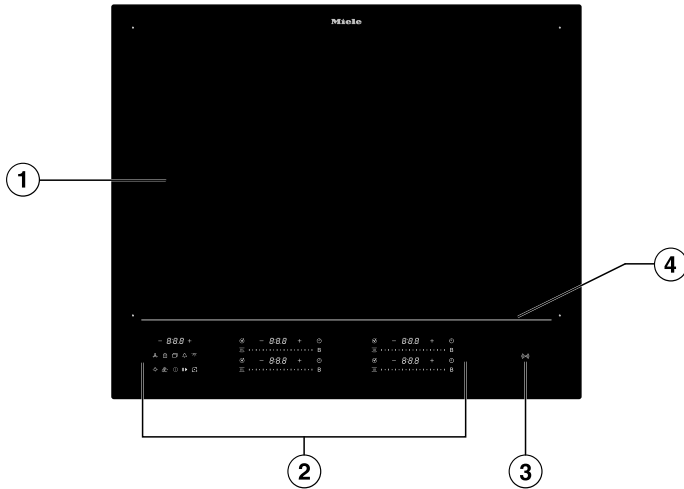

- ① Useable surface of the hob for a maximum of 4 items of cookware
- ② Controls and indicators
- ③ Display *NFC icon* (📶)
- ④ Light line

# Familiarisation

## KM 8885-2 FL Diamond and M Sense

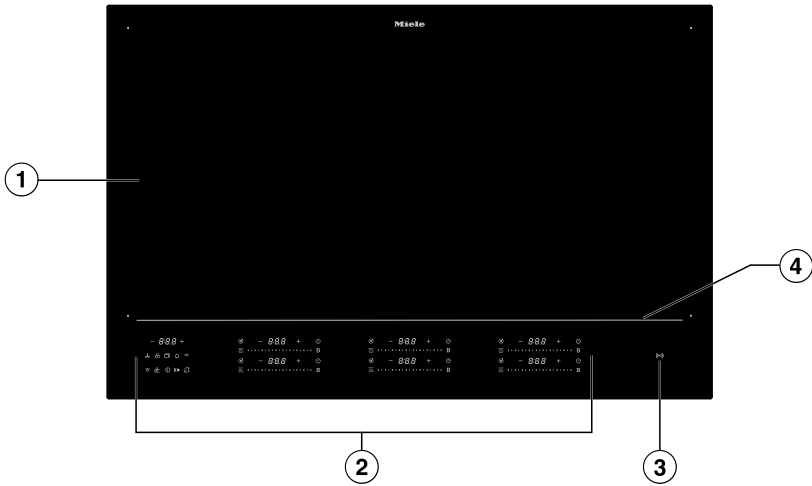

- ① Useable surface of the hob for a maximum of 6 items of cookware
- ② Controls and indicators
- ③ Display *NFC icon* ((☎))
- ④ Light line

## KM 8895-2 FL Diamond and M Sense

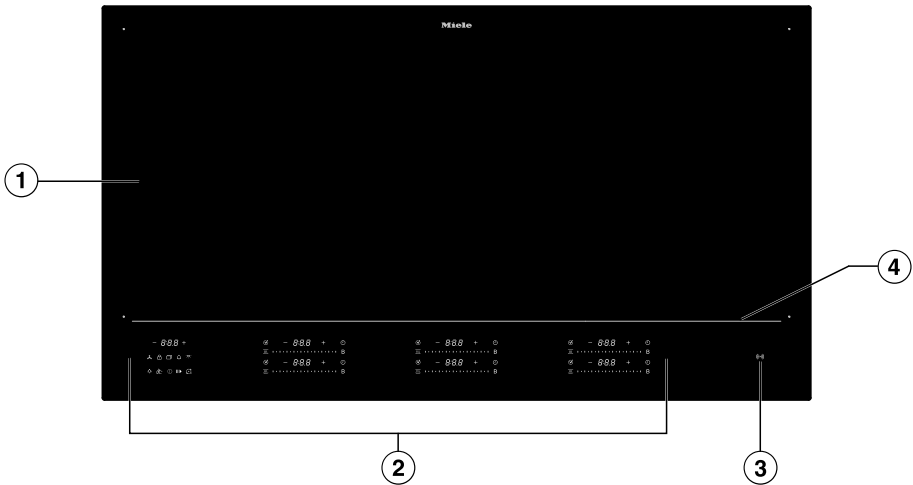





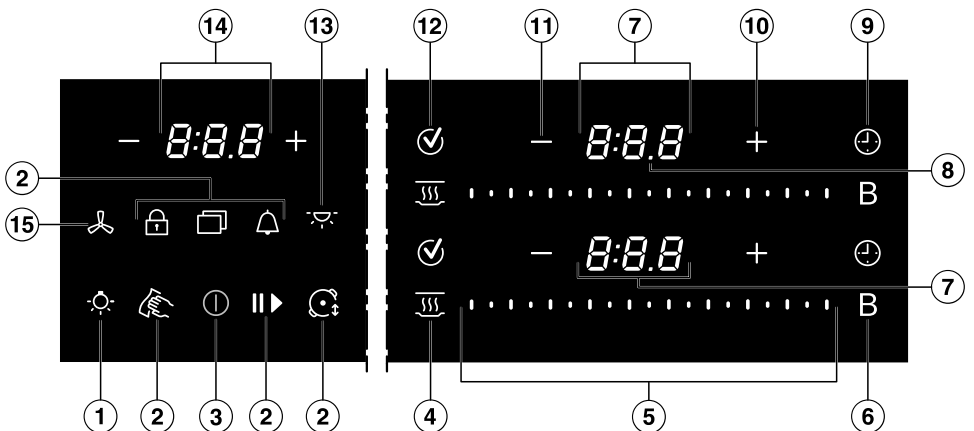















- ① Useable surface of the hob for a maximum of 6 items of cookware
- ② Controls and indicators
- ③ Display *NFC icon* ((☎))
- ④ Light line



## Controls and indicators



# Familiarisation

---

- ① *Hob lighting of a Miele cooker hood*  sensor control
- ② *Menu*  sensor control to display the following sensor controls
  -  *Wipe protection* sensor control to lock the control elements and indicators for 20 seconds
  -  *Timer* sensor control: an alarm for activities that are independent of the hob
  -  *Stop&Go* sensor control to stop/start a cooking process in progress
  -  *System lock/Keypad lock* sensor control to lock the control elements and indicators
  -  *Professional mode* sensor control to change the power level by the position of the cookware
- ③ *On/Off*  sensor control
- ④ *Keeping warm*  sensor control  
To activate/deactivate the Keeping warm special function
- ⑤ Slider
  - To set the power level
  - To set the times
- ⑥ *Booster B* sensor control
- ⑦ Cookware display
  -  Cookware is ready for use
  -  *1.0 to 9.0* Power level
  -  *0:00–9:59* Time
  -  Residual heat indicator level 1
  -  Residual heat indicator level 2
  -  Residual heat indicator level 3
  -  Assistance from M Sense cookware
  -  Cookware missing or unsuitable
  -  *b* Booster
  -  *h* Keeping warm
- ⑧ Separator display  
Display of intermediate power levels
- ⑨ Sensor control for *Duration* of a cooking process   
Switches the heating of the cookware off automatically after a set period of time  
Measures the time a cooking process takes

- ⑩ *Plus* + sensor control
  - To adjust the settings
  - To adjust the times
- ⑪ *Minus* – sensor control
  - To adjust the settings
  - To adjust the times
- ⑫ *OK*  sensor control
- ⑬ *Ambient lighting of a Miele cooker hood*  sensor control
- ⑭ Hob display
  - 0:00–9:59* Time
  - LOC ON/OFF* System lock/Keypad lock is activated/deactivated
  - dE ON/OFF* Demo mode is activated/deactivated
  - UP* A software update is available.
- ⑮ *Cooker hood*  sensor control
  - For selecting a cooker hood to set a power level

# Familiarisation

## Power management

### Effects of power distribution

While the Booster is in operation, some of the power is taken away from the other induction coils. If an induction coil gives power to another coil, this can have the following effects:

- Auto heat-up is deactivated.
- The power level is reduced.
- The heating is switched off.

## Operation

### Hob when switched off

Only the printed symbol for the On/Off ① *On/Off* sensor control is visible when the hob is switched off. More sensor controls light up when the hob is switched on.

### Operation

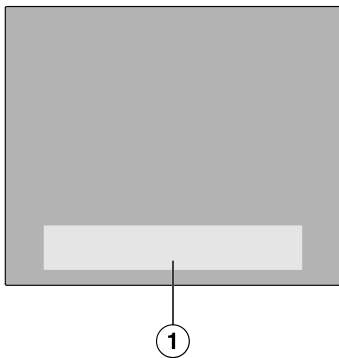

① Area for sensor controls and displays

This ceramic glass hob is equipped with sensor controls which react to finger contact.

Each time a sensor control is activated, a buzzer sounds.

For safety reasons, the On/Off ① *On/*

*Off* sensor control needs to be touched for a little longer than the other sensors in order to switch the appliance on.

## Networking

Your hob is equipped with an integrated WiFi module. The hob can be connected to your home network or just to your Miele cooker hood. The WiFi module enables the Miele app to be used on a mobile device.

Once your hob has been connected via WiFi, the connection is automatically re-established every time it is switched on.

Make sure that your WiFi network signal is strong enough in the place where you intend to install your hob.

Connecting your hob to your WiFi network will increase energy consumption, even when the hob is switched off.

### Smart Extras via the Miele app\*

Networking via the Miele app gives you access to numerous Smart Extras, including:

- Access status information.
- Use additional helpful functions.
- Keep your hob up to date with the latest Miele developments via software updates (only possible via WiFi connection).

You can find more detailed information about Smart Extras on the Miele website, in the Apple App Store® or in the Google Play Store™.

\*This is a separate digital offer from Miele & Cie. KG. The range of functions can vary depending on the model and the country. Acceptance of the Terms and Conditions and Privacy Policy for Miele digital products & services in the Miele app required. Miele reserves the right to change or discontinue the digital offer at any time.

## Special functions

### M Sense cookware ready

The hob is suitable for M Sense cookware.

M Sense cookware features sensors. These sensors simplify the cooking process.

M Sense cookware can be purchased as optional accessories. It is available to order in the Miele online shop, from Miele Customer Service or from your Miele dealer.

### Controlling a cooker hood

#### Con@ctivity 3.0

Con@ctivity 3.0 is the direct communication system between your hob and a Miele cooker hood. Communication is achieved by means of networking.

Con@ctivity 3.0 enables the cooker hood to operate automatically depending on the operating status of your hob.

The Con@ctivity versions of the hob and cooker hood must match.

Further information can be found in the operating and installation instructions for your cooker hood.

### Permanent pan recognition

When you place cookware on the hob surface, the Slider for the cookware is activated automatically.

### Pan size recognition

The size of the cookware is detected on the hob surface. The release of energy is adapted to the size of the pan.

### Hob Booster

When the Booster function is activated, the power is boosted so that large quantities can be heated up quickly, e.g. when boiling water for cooking pasta.

### Stop&Go

When Stop&Go is activated, all power levels are reduced to 1.

When the function is deactivated, the appliance switches back to the power level that was set last.

**Tip:** Use this special function if there is a danger of food boiling over.

### Hob power levels

You can set the power for the cookware in levels from 1 to 9.

There is an intermediate level between each power level. The intermediate levels allow you to fine-tune the power settings.

If you do not need the intermediate levels, you can deactivate the intermediate levels via the settings.

### Auto heat-up

When auto heat-up has been activated, the cooking zone switches on automatically at the highest setting (heat-up boost) and then switches to the power level (continued cooking setting) which you have previously selected.

# Familiarisation

## Timer functions

There are 3 timer functions:

- Timer
- Duration of a cooking process
- Elapsed time of a cooking process

You can use the functions simultaneously.

## Timer

You can set an alarm for activities that are independent of the hob.

## Duration of a cooking process

You can set a time after which a cooking zone will switch off automatically. This function can be used for all cooking zones at the same time.

## Elapsed time of a cooking process

You can measure how long a cooking process takes.

## Professional mode

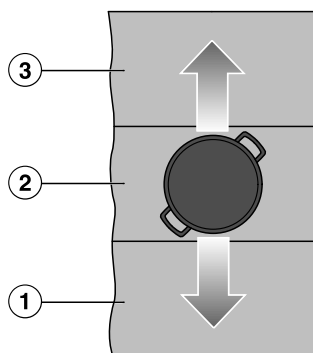

Example to visualise the concept.

- ① Cookware with power level 9
- ② Cookware with power level 5
- ③ Cookware with power level 2

In Professional mode, the hob surface is divided into 3 horizontal cooking areas. Each cooking area is assigned a power level.

Moving the cookware forwards ① and backwards ③ changes the power level at which the cookware is heated.

You can change the power levels.

Depending on the width of the hob, different numbers of cookware items can be heated in parallel.

## Light line

An illuminated line indicates the boundary between the cooking area and the controls and indicators.

## System lock

If the system lock is activated, then the hob cannot be switched on.

## Keypad lock

The keypad lock is activated when the hob is switched on. When the keypad lock is activated, the hob can be operated only under certain conditions.

## Recall

If the hob is switched off by mistake during use, this special function can be used to restore all settings.

## Keeping warm

This special function enables food to be kept warm after it has finished cooking.

## Wipe protection

The hob sensor controls can be locked for 20 seconds to remove soiling, for example. ① On/Off is not locked.

## Settings

You can adapt the settings of the hob to your personal needs.

## Demo mode

This special function enables the hob to be demonstrated in dealer showrooms without heating up.

## Demo mode

In demo mode, cooking processes are simulated in an infinite loop. The sequence of the individual steps is repeated after 1 minute. When you touch a sensor control or place an item of cookware on the hob, it switches to demo mode.

## Residual heat indicator

If an area of the ceramic surface is hot, the residual heat indicator will light up after the hob has been switched off.

The bars of the residual heat indicator go out one after the other as the ceramic surface cools down. The last bar only goes out when the ceramic surface is safe to touch.

## Safety switch-off

### Sensor controls are covered

Your hob will switch off automatically if one or several of the sensor controls remain covered for longer than 10 seconds; for example, by finger contact, food boiling over or by an object.  will flash briefly in the Hob display and a buzzer will sound.

 will go out once you have removed the obstruction and/or soiling and the hob will be ready to use again.

### Excessive operating time

The safety switch-off is triggered automatically if an area is heated for an unusually long period of time. This time depends on the power level selected. If it has been exceeded, the heat switches

off and the residual heat indicator appears. A power level can be selected in the usual way.

You can adjust the safety switch-off by changing the safety setting.

# Familiarisation

Special function/ power level	Maximum operating time [h:min]		
	Safety setting		
	0 <sup>1</sup>	1	2
Keeping warm	2:00	2:00	2:00
1.0	10:00	8:00	5:00
1.5	10:00	7:00	4:00
2.0/2.5	5:00	4:00	3:00
3.0/3.5	5:00	3:30	2:00
4.0/4.5	4:00	2:00	1:30
5.0/5.5	4:00	1:30	1:00
6.0/6.5	4:00	1:00	00:30
7.0/7.5	4:00	00:42	00:24
8.0	4:00	00:30	00:20
8.5	4:00	00:30	00:18
9.0	1:00	00:24	00:10
Assistance from M Sense cookware – no programme active	12:00	12:00	12:00
Assistance from M Sense cookware – programme active	12:00	3:00	1:00

<sup>1</sup> Factory default setting

## Overheating protection

In order to prevent the hob from being damaged by excessive temperatures, the overheating protection mechanism intervenes in one of the following ways:

### Overheating protection measures

- If the Booster function is switched on, it will stop.
- The set power level will be reduced.
- The heating will switch off automatically. *Err* flashes alternately with *044* in the Hob display.
- All cooking zones will switch off.

### Triggering the overheating protection mechanism

The overheating protection mechanism may be activated under the following circumstances:

- The cookware being heated is empty.
- Fat or oil is being heated on a high power level.
- Insufficient ventilation to the underside of the hob.
- A hot zone being switched on after a power cut.

### Model identifier and serial number

Your hob can display the model identifier and serial number.

### Software version

Your hob can display its software status.

### Software update

To receive updates, you must be connected to your home network.

A message will appear on the Hob display as soon as a new update is available.

When it comes to updates, you can:

- Install them immediately
- Postpone them and carry out at a later date
- Switch them off permanently

If you do not install an update or install it later, you can continue to use your hob as usual. However, Miele recommends installing the updates as soon as possible.

## **Optional accessories**

Products specially tailored to your hob – such as cookware and cleaning agents – are available from the Miele online shop, Miele Customer Service or your Miele specialist dealer.

You can access the Miele online shop via the following QR code:



# Commissioning

## Unpacking the hob

- Please stick the data plate for the appliance, supplied with this documentation, in the space provided in the “After sales service” section of this booklet.
- Remove any protective foil and stickers.

## Cleaning the hob for the first time

- Before using for the first time, clean the hob with a damp cloth.
- Wipe the hob dry.

## Switching on the hob for the first time

The metal components have a protective coating. When the hob is used for the first time, this causes a smell and possibly also vapour. The heating of the induction coils also causes odours in the first few hours of operation. With each subsequent use, the odour is reduced until it disappears completely.

The odour and any vapours given off do not indicate a faulty connection or appliance and they are not hazardous to health.

## Networking

You can use your hob:

- To connect to your home network with your mobile device
- To network directly with your Miele cooker hood

Both types of networking allow you to control your cooker hood.

Networking with your mobile device allows you to utilise additional functions. See “Familiarisation – Networking” for more information.

## Requirements for networking with your home network

Note the following requirements for networking:



1. A home network is available at the installation site.  
Have the WiFi password ready.
2. The Miele app is available on a mobile device.
3. You have a user account in the Miele app.
4. There is no direct WiFi connection between the hob and your Miele cooker hood.

You have 2 options for connecting your hob to the home network:

- NFC
- Scan & Connect

Both options lead to the same result.

## Using NFC

The  *NFC icon* display is activated automatically the first 20 times the hob is switched on. When you switch on the hob for the 21st time, the  *NFC icon* display must be activated manually.

The NFC function on your mobile device is activated.

- Switch the hob on.
- Move your mobile device gently over the  *NFC icon* display at a distance of  $\leq 1$  cm.

If you have installed the Miele app and have a user account, you will be taken directly to the networking steps.

If you have not yet installed the Miele app, you will be taken to the Apple App Store® or the Google Play Store™.

- Install the Miele app and set up a user account.
- Once again, move your mobile device gently over the (📶) *NFC icon* display at a distance of > 1 cm.

The Miele app will guide you through the setup process.

**Tip:** If you cannot find the (📶) *NFC icon* display on your hob, access the model identifier, for example. The display (📶) *NFC icon* will then light up.

## Performing Scan & Connect



- Scan the QR code.

If you have installed the Miele app and have a user account, you will be taken directly to the networking steps.

If you have not yet installed the Miele app, you will be taken to the Apple App Store® or the Google Play Store™.

- Install the Miele app and set up a user account.
- Scan the QR code again.

The Miele app will guide you through the setup process.

## Requirements for direct networking with your Miele cooker hood

Note the following requirements for networking:

1. Your Miele cooker hood has Con@ctivity 3.0.

2. The hob is not networked with your home network.

## Networking your hob with your Miele cooker hood

You can find the necessary information on connecting the cooker hood in the associated operating and installation instructions.

- Start the connection setup on the cooker hood.
- Switch the hob on.

If the connection was successful, the code  $\text{E:02}$  appears in the Hob display. If the connection could not be established, the Hob display will show the code  $\text{E:01}$ . Repeat the steps above.

Con@ctivity 3.0 is now activated.

## Resetting settings

- Reset the settings when you switch from one networking option to another.
- Reset the settings if you are disposing of your hob, selling it or putting a used hob into operation. This is the only way to ensure that all personal data has been removed and the previous owner will no longer be able to access the hob.

Resetting is not required when replacing the router.

- Switch the hob off.
- Touch  $\text{⓪}$  *On/Off* for approx. 6 seconds. The seconds can be seen counting down in the Hob display.

The Hob display shows *P*.

The Cookware displays show the following:

# Commissioning

---

- 9 and a number indicate the selected quick parameter.
- Depending on the model:
  - £ and a number indicate the selected code of the selected quick parameter.

Other sensor controls light up.

The (NFC icon) *NFC icon* display lights up brightly.

- Touch + *Plus* or the Slider at the top right next to the Hob display repeatedly until the corresponding Cookware display shows the following: 909
- Touch ✓ *OK*.
- Touch + *Plus* or the Slider at the bottom right next to the Hob display repeatedly until the corresponding Cookware display shows the following: £01
- Touch ✓ *OK* at the bottom right next to the Hob display.

The WiFi settings are reset. £01 is displayed in the Cookware displays.

## Safety notes for operation

⚠ Risk of fire due to overheated food.

Unattended food can overheat and catch alight.

Do not leave the hob unattended whilst it is being used.

⚠ Risk of burning due to hot ceramic surface.

The ceramic surface will be hot after use.

Do not touch the ceramic surface while the residual heat indicators are on.

⚠ Risk of burning due to hot items.

When the hob is switched on either deliberately or by mistake, or when there is residual heat present, there is the risk of metal items placed on the hob heating up.

Do not use the hob as a resting place for anything.

After use, switch the hob off with the ① sensor control.

⚠ Placing hot cookware on the sensor controls and displays can damage the electronic module underneath.

The sensor controls do not respond.

They may be switched on or off unintentionally.

The hob switches itself off.

Do not place hot cookware over the sensor controls or displays.

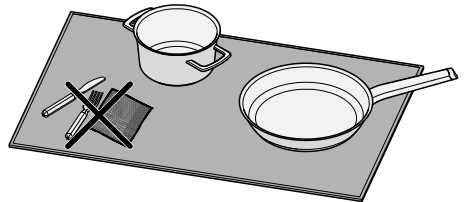

⚠ The hob cannot distinguish between cookware and objects next to cookware.

The objects will be heated too. Touching hot objects can cause burning.

Do not place objects on the hob. Only place the cookware on the hob.

► Never heat pans with a non-stick coating with the Booster.

## Switching the hob on

■ Touch ① *On/Off*.

Other sensor controls light up.

# Operation

If no further entry is made, the hob will switch itself off after a few seconds for safety reasons.

## Switching the hob/cookware off

### Switching the hob off

- To switch off the hob and all cookware, touch **1 On/Off**.

### Switching cookware off

- Touch **⏏** on the corresponding Slider.

## Positioning cookware

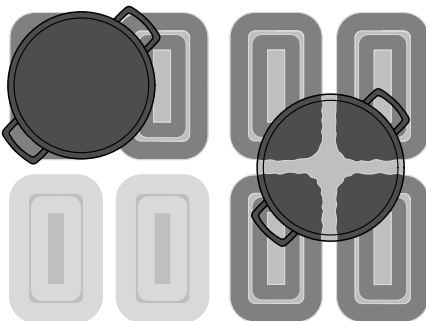
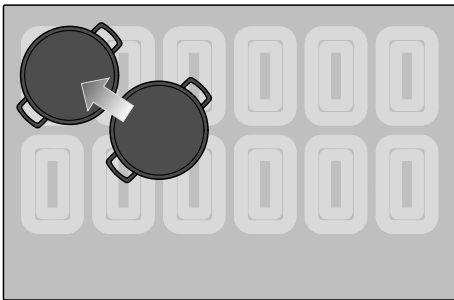

Example to visualise the concept.

You can position the cookware anywhere on the useable hob surface.

Induction coils are located under the entire useable hob surface. The induction coils are used to heat the cookware.

The induction coils are activated as soon as the cookware covers a certain area of the induction coils. If you are not satisfied with the cooking or frying results, you can reposition the cookware so that more of the base surface is heated.

It can be a good idea to position the cookware in a corner of the useable hob surface.

## Number of cookware items and size

- With the KM 8765 FL Diamond models, a maximum of 4 items of cookware (including a maximum of 4 M Sense items of cookware) can be used at the same time.
- With the KM 8885 FL Diamond&MSense, KM 8895 FL Diamond&MSense models, a maximum of 6 items of cookware (including a maximum of 4 M Sense items of cookware) can be used at the same time.

Depending on the position, cookware with a base diameter between 100 and 145 mm will not be detected in every position on the hob. These items of cookware are too small to guarantee that at least one induction coil will be covered sufficiently in every position.

Cookware with a base diameter of < 100 mm is no longer detected and cannot be used.

- If you are using several items of cookware at once, position them as far apart as possible. This will enable the hob to detect each of them individually.
- Move items of cookware on the hob one after the other, not all at the same time.

When you move an item of cookware on the hob, the associated Slider lights up. The set power level “goes along” with it.

**Tip:** We recommend switching the hob on first and then placing the cookware on it. If you do this, the cookware will be detected more quickly by the hob.

## Hob power levels

### Setting the power level for cookware

Permanent pan recognition is activated as standard. When the hob is switched on and you place an item of cookware on a cooking zone, the Cookware display lights up brightly.

- Place the cookware in the required position on the hob surface.

The corresponding Cookware display lights up brightly.

- Swipe to the right or left on the corresponding Slider until the corresponding Cookware display shows the required power level.

The power level is displayed in the corresponding Cookware display.

### Setting the power level for cookware – without intermediate levels

Permanent pan recognition is activated as standard. When the hob is switched on and you place an item of cookware on a cooking zone, the Cookware display lights up brightly.

The setting range for the power levels without intermediate levels has been selected in the settings.

- Place the cookware in the required position on the hob surface.

The corresponding Cookware display lights up brightly.

- Swipe to the right or left on the corresponding Slider until the corresponding Cookware display shows the required power level.

The power level is displayed in the corresponding Cookware display.

### Changing the power level for cookware

- Touch the position for the power level you want on the corresponding Slider.

## Booster

### Activating the Booster

The Booster special function cannot be operated together with activated M Sense cookware.

When the Booster is activated, the settings for the linked cooking zone may be changed.

KM 8765 FL Diamond:

You can use the Booster function for a maximum of 2 items of cookware at the same time: 1 on the right-hand side of the hob and 1 on the left-hand side.

# Operation

---

KM 8885 FL Diamond&MSense, KM 8895 FL Diamond&MSense:

You can use the Booster function for a maximum of 3 items of cookware at the same time: 1 on the right-hand side of the hob, 1 in the middle and 1 on the left-hand side.

The Booster function is active for a maximum of 15 minutes.

- Place the cookware in the required position on the hob surface.
- Select a power level if necessary.
- Touch the Booster B sensor control.

The Cookware display shows *b*.

## Deactivating the Booster

- Touch B *Booster*.

or

- Set another power level.

If you deactivate the Booster function or the Booster time comes to an end and

- no power level was selected before activating the Booster, the cooking zone will revert automatically to level 9.
- a power level was selected before activating the Booster, the cooking zone will revert automatically to the previously selected level.

## Activating/deactivating Stop&Go

This function does not work with M Sense cookware.

All timer functions, booster times and heat-up boost times continue to run. The timer settings cannot be changed. The hob can only be switched off.

The Stop&Go special function is active for 3 minutes when using M Sense cookware.

If the special function is not deactivated within 1 hour, the hob will switch off.

- Touch  *Menu*.
- Touch **II** ▶ *Stop&Go*.

The active heating of the cookware is reduced from the set power level to power level 1.0 or switched back again.

Cookware with Keeping warm function is not changed.

## Auto heat-up

The heat-up time depends on which continued cooking setting has been chosen:

Continued cooking setting	Heat-up time [min:sec] <sup>1</sup>
1.0	Approx. 0:15
1.5	Approx. 0:15
2.0	Approx. 0:15
2.5	Approx. 0:15
3.0	Approx. 0:25
3.5	Approx. 0:25
4.0	Approx. 0:50
4.5	Approx. 0:50
5.0	Approx. 2:00
5.5	Approx. 5:50
6.0	Approx. 5:50
6.5	Approx. 2:50
7.0	Approx. 2:50
7.5	Approx. 2:50
8.0	Approx. 2:50
8.5	Approx. 2:50
9.0	—

<sup>1</sup> If the cookware is temporarily removed from the hob surface during the heat-up time, the heat-up time is extended by the time without cookware.

## Activating auto heat-up

This function does not work with M Sense cookware.

No timer functions can be set during the heat-up time. If an elapsed time display is running, it is cancelled.

- Hold down the required continued cooking setting on the Slider for approx. 3 seconds until a buzzer sounds.

The power level pulsates while the heat-up boost (power level 9) is running.

## Deactivating auto heat-up

- Set another power level.
- or
- Set the same power level again.

## Timer functions

There are 3 timer functions:

- Timer
- Duration of a cooking process
- Elapsed time of a cooking process

You can use the functions simultaneously.

## Setting the timer

- Touch  *Menu*.
- Touch  *Timer*.

The Hob display lights up brightly,  *Timer* lights up brightly and pulsates. Other sensor controls and displays light up dimly.

- Set the required time for the timer.

Touch  *Timer* or wait 5 seconds to start the timer.

 *Timer* will start to flash 10 seconds before the time has elapsed.

# Operation

## Changing the timer

- Touch  *Timer*.

The Hob display lights up brightly.  *Timer* lights up brightly and pulsates. Other sensor controls and displays light up dimly.

- Set the required time for the timer.

Touch  *Timer* or wait 5 seconds to start the timer.

## Deleting the timer

- Hold down  *Timer* until the set time is no longer shown in the Hob display.

or

- Set the timer to the value 0:00.

## Setting the time for a duration

A time of between 1 minute (0:01) and 9 hours 59 minutes (9:59) can be set.

Times of up to 59 minutes are shown in minutes (00:59) and times of more than 60 minutes are shown in hours and minutes.

The time is entered using the corresponding Slider and can be adjusted using the corresponding + *Plus* and the corresponding - *Minus*.

- Move the slider to the left or right until the required time is shown in the corresponding Cookware display.

Example:

59 minutes = 00:59 hours,

80 minutes = 1:20 hours

## Setting the duration of a cooking process

The heating for an item of cookware will switch off when the maximum operating time has elapsed, regardless of the duration that has been set.

A power level is set for the desired item of cookware.

- Briefly (< 1.5 seconds) touch the  *Duration* next to the corresponding Cookware display.

The corresponding Cookware display lights up brightly and  *Duration* pulsates. Other sensor controls and displays light up dimly.

- Set the required time for the duration.

Touch  *Duration* or wait 5 seconds to start the duration.

The duration of a cooking process runs down and  *Duration* lights up constantly.

The corresponding  *Duration* will start to flash 10 seconds before the time has elapsed.

## Changing the duration of a cooking process

- Briefly (< 1.5 seconds) touch  *Duration* for the cookware you want to use.

The corresponding Cookware display lights up brightly and  *Duration* pulsates. Other sensor controls and displays light up dimly.

- Set the required time for the duration.

Touch  *Duration* or wait 5 seconds to start the duration.

The duration of a cooking process runs down and  *Duration* lights up constantly.

## Deleting the duration of a cooking process

- Hold down  *Duration* for the cookware you want to use until the Cookware display shows 0:00.

or

- Touch the  *Duration* for the cookware.

The corresponding Cookware display lights up brightly. Other sensor controls and displays light up dimly.

- Touch  on the corresponding Slider.

## Setting a duration for further cooking processes

- To set a duration for a further cooking process, follow the same steps as described under “Operation – Setting the duration of a cooking process”.

## Starting elapsed time measurement of a cooking process

- A power level is set for the desired item of cookware.
- A duration must not be set for the cookware.

- Touch and hold (> 1.5 seconds)  *Duration* next to the corresponding Cookware display.

The Cookware display shows the time that has elapsed since activation.

## Cancelling elapsed time measurement of a cooking process

- Hold down  *Duration* for the cookware you want to use until the corresponding Cookware display shows **0:00**.

## Starting elapsed time measurement of further cooking processes

- To set an elapsed time for a further cooking process, follow the same steps as described under “Operation – Starting elapsed time measurement of a cooking process”.

## Switching between the power level display and timer function display

- Touch the required Cookware display to switch between the timer function display and the power level display for an item of cookware.

## Professional mode

### Activating Professional mode

The Professional mode special function cannot be operated together with activated M Sense cookware.

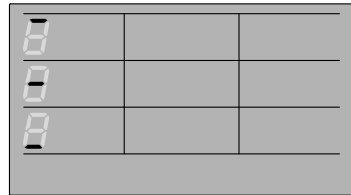

Professional mode cooking areas on a hob > 60 cm; the horizontal lines correspond to the cooking areas

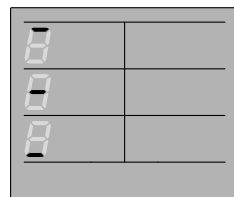

Professional mode cooking areas on a hob ≤ 60 cm; the horizontal lines correspond to the cooking areas



# Operation

In Professional mode, you can place one item of cookware on the hob per column. This means the following applies:

- If the hob is > 60 cm, you can place a total of 3 items of cookware on it.
- If the hob is ≤ 60 cm, you can place a total of 2 items of cookware on it.

The factory default (000) or ≥ 004 (3680 W) must be set in the settings under P21 power management.

There must not be any cookware on the hob.

- Touch  *Menu*.
- Touch  *Professional mode*.
- Place an induction-compatible item of cookware on the hob.

 *Timer* lights up.

 *Keeping warm* lights up.

The Slider lights up.

In the Cookware display:

- A horizontal line indicates the area in which the cookware is placed.
- The power level for the area in which the cookware is placed is displayed.



## Changing the power levels for the hob areas in Professional mode

- The movement direction for the pots is set from front to back as standard. This means that the highest power level is at the front and the lowest power level is at the back.
- You can permanently change the movement direction via P23 Movement direction for Professional mode to suit your cooking preferences.

- The Keeping warm special function and all power levels can be set for the areas. The Booster special function cannot be set.

- In line with the movement direction, the power levels of the successive areas must not exceed or fall below the specified values.

- Place the cookware in the area whose power level you want to change.

Hob area	Hob area symbol	Default power level	Highest possible power level <sup>1</sup>	Lowest possible power level <sup>1</sup>
Front		9	9	> middle hob area
Middle		5	< front hob area	> front hob area
Back		2	< middle hob area	Keeping warm special function

<sup>1</sup> When the movement direction is set from front to back (factory default). If the movement direction is switched round, the information indicated in the columns must also be switched.

- Use the Slider sensor control to set the power level according to the options in the table.

## Deactivating Professional mode

- Touch  *Professional mode*.

## System lock

### Activating the system lock

The system lock has no effect on M Sense cookware.

All sensor controls are locked. A set timer continues to run.

- The hob is switched on.
- All cooking zones are switched off.

■ Touch  *Menu*.

■ Touch and hold  *System lock* for 6 seconds.

The seconds can be seen counting down in the Hob display. Once the time has elapsed, the Hob display shows *LDC* alternating with *On*. The system lock is activated.

If a disallowed sensor control is touched while the system lock is activated, the Hob display will show *LDC* alternating with *On* for a few seconds. A buzzer sounds.

The settings can be adjusted so that the system lock is activated automatically 5 minutes after the hob has been switched off.

### Deactivating the system lock

■ Touch and hold  *System lock* for 6 seconds.

The seconds can be seen counting down in the Hob display. Once the time has elapsed, the Hob display shows *LDC* alternating with *OFF*. The system lock is deactivated.

## Keypad lock

### Activating the keypad lock

This function does not work with M Sense cookware.

When the keypad lock is activated, only the following actions can be performed:

- The heating for cookware and the hob can only be switched off.
- A set timer can be changed.

Heating for at least one item of cookware is switched on.

■ Touch  *Menu*.

■ Touch and hold  *Keypad lock* for 6 seconds.

The seconds can be seen counting down in the Hob display. Once the time has elapsed, the Hob display shows *LDC* alternating with *On*. The keypad lock is activated.

If a disallowed sensor control is touched while the keypad lock is activated, the Hob display will show *LDC* alternating with *On* for a few seconds. A buzzer sounds.

### Deactivating the keypad lock

■ Touch and hold  *Keypad lock* for 6 seconds.

The seconds can be seen counting down in the Hob display. Once the time has elapsed, the Hob display shows *LDC* alternating with *OFF*. The keypad lock is deactivated.

# Operation

## Recall

### Activating the Recall function

This function does not work with M Sense cookware.

The hob must be switched on again within 10 seconds of being switched off.

- Switch the hob on again.
- Immediately after switching the hob on, touch the flashing  *OK*.

All settings are restored.

### Discarding the Recall function



- Switch the hob on again.
- Immediately after switching the hob on, touch one of the Cookware displays that are **NOT** flashing.

The new setting is applied; all other settings are discarded.

## Wipe protection

### Activating wipe protection

This function does not work with M Sense cookware.

- Touch  *Menu*.
- Touch  *Wipe protection*.

The time that wipe protection is active counts down in the Hob display.

### Deactivating wipe protection

- Touch  *Wipe protection* until the Hob display disappears.

## Using M Sense cookware

The relevant operating and installation instructions describe how to use the M Sense cookware.

You can use all the special functions on your hob with the M Sense cookware, unless otherwise specified in these operating and installation instructions.

The entries on the hob take precedence over the entries on the cookware and can deactivate cookware actions.

### M Sense cookware: activating special functions on the hob

- Activate a programme on the cookware.
- Activate the special functions on the hob.

The corresponding Cookware display on the hob shows the display corresponding to the special functions. Alternating with this, Assistance from M Sense cookware *A* is displayed.

### M Sense cookware: deactivating special functions on the hob

- Deactivate the special function on the hob.

Assistance from M Sense cookware is ended. The hob behaves according to the most recent settings.

### Ending assistance from M Sense cookware

We recommend always using M Sense cookware in assistance mode.

- Switch off the M Sense cookware.

## Hob data

### Displaying the model identifier/serial number



There must not be any cookware on the hob.

- Switch the hob off.

- Touch  *On/Off* for approx. 6 seconds. The seconds can be seen counting down in the Hob display.

The Hob display shows *P*.

The Cookware displays show the following:

-  and a number indicate the selected quick parameter.
- Depending on the model:
  -  and a number indicate the selected code of the selected quick parameter.

Other sensor controls light up.

The  *NFC icon* display lights up brightly.

- Touch  *Plus* or the Slider at the top right next to the Hob display repeatedly until the corresponding Cookware display shows the following: *903*

- Touch  *OK*.

Numbers will appear in the Hob display one after another, separated by a dash.

Example: *12 34* (model identifier KM 1234) – *1 23 45 67 89* (serial number)



## Displaying the software version

There must not be any cookware on the hob.

- Switch the hob off.
- Touch  *On/Off* for approx. 6 seconds. The seconds can be seen counting down in the Hob display.

The Hob display shows *P*.

The Cookware displays show the following:

-  and a number indicate the selected quick parameter.
  - Depending on the model:
    -  and a number indicate the selected code of the selected quick parameter.
- Other sensor controls light up.
- The  *NFC icon* display lights up brightly.





- Touch  *Plus* or the Slider at the top right next to the Hob display repeatedly until the corresponding Cookware display shows the following: *902*

- Touch  *OK*.

3 numbers appear in the Hob display:  
Example: *1.23* = software version 1.23.

## Activating/deactivating demo mode

There must not be any cookware on the hob.

- Switch the hob off.
  - Touch  *On/Off* for approx. 6 seconds. The seconds can be seen counting down in the Hob display.
- The Hob display shows *P*.
- The Cookware displays show the following:
-  and a number indicate the selected quick parameter.
  - Depending on the model:
    -  and a number indicate the selected code of the selected quick parameter.
- Other sensor controls light up.
- The  *NFC icon* display lights up brightly.

# Operation

---

- Touch + *Plus* or the Slider at the top right next to the Hob display repeatedly until the corresponding Cookware display shows the following:  $910$
- Touch  $\checkmark$  *OK*.
- Touch + *Plus* or the Slider at the bottom right next to the Hob display repeatedly until the corresponding Cookware display shows the following:  $001$
- Touch  $\checkmark$  *OK* at the bottom right next to the Hob display.

The following will flash in the Hob display for a few seconds:

- $dE$  alternating with  $0n$  (demo mode activated)  
or
- $dE$  alternating with  $0FF$  (demo mode deactivated)

## Activating/deactivating demo mode

- Activate/deactivate demo mode via the settings ( $P52$ ).

## Setting ranges for the hob power levels

The hob is programmed with 9 power levels with intermediate levels at the factory. If you only want to use the whole-number settings for power levels, you can deactivate intermediate levels via the settings.

	Recommended cookware <sup>1</sup>	Setting range <sup>2</sup>	
		Factory setting 9 levels with intermediate levels	Whole numbers 9 levels without intermediate levels
Melting butter	Pot	1.0–1.5	1–2
Dissolving gelatine			
Keeping warm food which sticks easily		1.0–2.0	
Melting chocolate			
Heating small quantities of liquid		2.0–3.5	2–4
Cooking rice			
Defrosting frozen vegetables in a block			
Making milk puddings			
Warming up liquid and semi-solid food		3.5–5.5	4–6
Steaming fruit			
Simmering potatoes			
Rendering bacon	Frying pan	5.0–6.5	5–6
Making omelettes, lightly fried eggs, etc.	Frying pan with sandwich base and non-stick coating		
Steaming fish	Pot	4.5–6.5	5–7
Steaming vegetables			
Cooking pasta and pulses			
Thickening sauces, e.g. Hollandaise			
Defrosting and reheating frozen food	See manufacturer's instructions	6.0–6.5	6
Gentle frying (e.g. whole fish)	Frying pan with sandwich base and non-stick coating		
Gentle frying (e.g. meat patties, chicken breast)	Frying pan		
Frying (e.g. fish fillet, escalopes, fried eggs)			
Making pancakes	Frying pan with sandwich base and non-stick coating	6.0–7.0	6–7
Searing/hot frying (e.g. steak, small quantities of meat, fried potatoes, hash browns)	Frying pan	7.0–8.5	7–8
Frying, e.g. chips	Pot with high rim	8.5–9.0	9
Searing large quantities of meat	Pot with high rim or oven dish		
Bringing water to the boil	Pot	Booster	Booster

<sup>1</sup> Cook in covered pots and pans if possible. This prevents heat escaping unnecessarily.

<sup>2</sup> These settings should only be taken as a guide. The power of the induction coils will vary depending on the size and material of the cookware. For this reason, the power levels may need to be adjusted slightly to suit your cookware. As you use the hob, you will get to know which settings suit your cookware best. When using new cookware that you are not familiar with, set the power level to one level below the one specified.

# Setting ranges for the hob power levels

---

## Notes for test institutes

Test food acc. to EN 60350-2

Test food	∅ cookware base (mm)	Lid	Setting range	
			Pre-heat- ing	Cooking
Heating oil up	150	No	–	1.0–1.5
Pancakes	180 (sandwich base)	No	9.0	6.0–7.0
Frying frozen chips	180 (chip pan)	No	9.0	9.0
Keeping warm a lentil stew	150 (sandwich base)	Yes (when keeping warm)	7.0	Keeping warm

### How induction hobs work

Induction coils are located under the ceramic surface. These coils create a magnetic field that reacts directly with the base of the cookware and heats it up. The ceramic surface itself is heated up indirectly by the heat given off by the cookware.

The position, size and shape of the cookware are detected automatically by the induction hob.

An induction cooking zone only works when cookware with a magnetic base is placed on it.

### Noises

The following noises can occur in the cookware, depending on what it is made of and how it has been constructed:

Buzzing on the higher power levels. This will decrease or cease altogether when the power level is reduced.

If the cookware is made of layers of different materials (e.g. in a sandwiched base), it might emit a crackling sound.

You might hear a clicking sound from the electronic switches, especially at lower power levels.

A whirring sound, when the cooling fan comes on. This switches on to protect the electronic module when the hob is being used intensively. The fan may continue to run after the appliance has been switched off.

### Cookware

#### Suitable cookware

- Stainless steel cookware with a magnetic base
- Enamelled steel cookware
- Cast iron

Please be aware that the properties of the cookware base can affect the evenness with which the food heats up (e.g. when making pancakes). The base of the cookware must be able to distribute the heat evenly. Cookware with a base made from multilayer material (sandwich or encapsulated base) is ideal in this case.

The cookware base material and the positions of the cookware on the hob affect the power of the induction coils. This can affect the cooking behaviour.

#### Cookware size

**Round** cookware should preferably have a base diameter from 145 mm up to a maximum of 350 mm. Cookware with a base diameter between 100 mm and 145 mm will not be detected in every position on the hob.

**Oval/square** cookware must not exceed dimensions of 380 mm x 300 mm.

#### Unsuitable cookware

- Stainless steel cookware without a magnetic base
- Aluminium or copper cookware
- Glass, ceramic or earthenware cookware

#### Testing cookware

To test whether a pot or pan is induction-compatible, hold a magnet to the base. If the magnet sticks, the pan is generally suitable.

## Good to know

---

### Cookware tips

- Use only pots and pans with smooth bases. Rough bases can scratch the ceramic surface.
- Always lift cookware to move it. This will help prevent scratching. If any scratches do appear as a result of cookware being pushed around, this will not affect the function of the hob. These scratches are normal signs of use and are not grounds for making a complaint.
- Please note that the cookware diameter quoted by manufacturers often refers to the maximum diameter or diameter of the top rim. The diameter of the base (generally smaller) is more important.

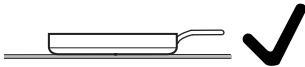

- Where possible, use cookware with vertically straight sides. If an item of cookware has angular sides, induction also acts on the sides of the item of cookware. The sides of the item of cookware may discolour or the coating may peel off.

## Accessing the Settings menu

There must not be any cookware on the hob.

- Switch the hob off.
- Touch  *On/Off* for approx. 6 seconds. The seconds can be seen counting down in the Hob display.

The Hob display shows *P*.

The Cookware displays show the following:

- *Q* and a number indicate the selected quick parameter.
- Depending on the model:
  - L* and a number indicate the selected code of the selected quick parameter.

Other sensor controls light up.

The  *NFC icon* display lights up brightly.

- Touch  *Stop&Go*.

The Hob display shows *PL*.

The Cookware displays show the following:

- *P* and a number indicate the selected parameter.

## Setting parameters

The Settings menu has been accessed.

- Touch *+* *Plus* or the Slider at the top right next to the Hob display repeatedly until the required parameter number is displayed in the corresponding Cookware display.
- Touch  *OK*.

The Slider,  *OK* and *+* *Plus* at the bottom right next to the Hob display light up.

The Cookware display at the bottom right next to the Hob display shows the currently set code number.

## Setting the code

A parameter must have been set.

- Touch *+* *Plus* at the bottom right next to the Hob display repeatedly until the required code number is displayed in the corresponding Cookware display.

- Touch  *OK*.

The setting is saved. You can now exit the settings or adjust further settings.

## Closing the Settings menu

Unsaved changes are not applied.

- Touch  *On/Off*.

## Adjusting settings

Parameter <sup>1</sup>		Code	Settings <sup>2</sup>
P01	WiFi registration	C00	<b>Not active/deactivated</b>
		C01	Active but not configured
		C02	Active and configured (cannot be selected; displays whether connection was successful)
		C03	Start connection via Bluetooth
		C04	WiFi reset to default (C01)
		C05	Restart wireless module
P03	Hob power level setting range	C00	<b>9 power levels with intermediate levels + Booster</b>
		C01	9 power levels without intermediate levels + Booster
P04	Keypad tone when a sensor control is touched	C00	Off <sup>3</sup>
		C01	Quiet
		C02	Medium
		C03	<b>Loud</b>
P05	Buzzer for timer functions	C00	Off
		C01	Quiet
		C02	Medium
		C03	<b>Loud</b>
		C04	Extra loud
P06	Buzzer for messages and faults	C00	Off (only possible for messages)
		C01	Quiet (minimum volume for faults)
		C02	Medium
		C03	<b>Loud</b>
P07	Maximum operating time	C00	<b>Safety setting 0</b>
		C01	Safety setting 1
		C02	Safety setting 2
P08	System lock	C00	<b>System lock can only be activated manually</b>
		C01	System lock activated automatically

## Adjusting settings

Parameter <sup>1</sup>		Code	Settings <sup>2</sup>
P09	Sensor control reaction speed	C00	Fast
		C01	<b>Normal</b>
		C02	Slow
P10	Reaction speed of Slider sensor control	C00	Fast
		C01	<b>Normal</b>
		C02	Slow
P12	Keeping warm temperature	C00	<b>65–75 °C</b>
		C01	50–55 °C
		C02	80–90 °C
P14	Hood control via hob – Con@ctivity 3.0	C00	<b>Activated</b>
		C01	Deactivated
P15	Contrast of sensor control lighting	C00	10 %
		C01	<b>20 %</b>
		C02	40 %
P16	Resetting settings	C00	<b>Reset nothing</b>
		C01	Reset all settings
		C02	Reset WiFi connection
		C03	Reset light line
		C04	Reset the M Sense cookware connection
P17	Factory default settings	C00	<b>Do not restore factory default settings</b>
		C01	Restore factory default settings

# Adjusting settings

Parameter <sup>1</sup>		Code	Settings <sup>2</sup>
P21	Power management <sup>4</sup>	C00	<b>Off</b>
		C01	1000 W
		C02	2000 W
		C03	3000 W
		C04	3680 W
		C05	4000 W
		C06	4500 W
		C07	5000 W
		C08	6000 W
		C09	7000 W
		C10	7400 W
		C11	8000 W
		C12	9000 W
		C13	10,000 W
P23	Movement direction for Professional mode	C00	<b>From the front (e.g. 9) to the back (e.g. 1)</b>
		C01	From the back (e.g. 9) to the front (e.g. 1)
P24	Poor cookware position indicator	C00	<b>Detection deactivated</b>
		C01	Detection activated
P40	M Sense cookware: altitude of the installation site	C00	0–300 m
		C01	301–600 m
		C02	601–900 m
		C03	901–1200 m
		C04	1201–1500 m
		C05	1501–1800 m
		C06	> 1800 m
		C07	<b>0–1800 m</b>

## Adjusting settings

Parameter <sup>1</sup>		Code	Settings <sup>2</sup>
P41	M Sense pot: target temperature for frying	C00	140 °C
		C01	145 °C
		C02	150 °C
		C03	155 °C
		C04	<b>160 °C</b>
		C05	165 °C
		C06	170 °C
		C07	175 °C
		C08	180 °C
P42	M Sense frying pan: target temperature for Frying I	C00	130 °C
		C01	135 °C
		C02	140 °C
		C03	145 °C
		C04	<b>150 °C</b>
		C05	155 °C
		C06	160 °C
		C07	165 °C
		C08	170 °C
P43	M Sense frying pan: target temperature for Frying II	C00	170 °C
		C01	175 °C
		C02	180 °C
		C03	185 °C
		C04	<b>190 °C</b>
		C05	195 °C
		C06	200 °C
		C07	205 °C
		C08	210 °C

# Adjusting settings

Parameter <sup>1</sup>		Code	Settings <sup>2</sup>
P44	M Sense frying pan: target temperature for Frying III	C00	190 °C
		C01	195 °C
		C02	200 °C
		C03	205 °C
		C04	<b>210 °C</b>
		C05	215 °C
		C06	220 °C
		C07	225 °C
		C08	230 °C
P47	Light line	C00	Switch off animation
		C01	<b>Standard</b>
		C02	Brighter
		C03	Darker
P52	Demo mode	C00	<b>Demo mode off</b>
		C01	Demo mode on <sup>5</sup>
		C02	Demo mode on <sup>5</sup>

<sup>1</sup> Parameters not shown here have no allocation.

<sup>2</sup> The factory default settings are printed in bold.

<sup>3</sup> The keypad tone of  $\textcircled{1}$  On/Off is not switched off.

<sup>4</sup> The total hob power may be reduced in order to meet the local power supply provider's requirements.  
Codes with values above the rated load of the hob are not displayed.

<sup>5</sup> After the hob has been switched on,  $dE$  appears alternately with  $On$  in the Hob display for a few seconds.

## Displaying the model identifier/ serial number

There must not be any cookware on the hob.

- Switch the hob off.
- Touch  *On/Off* for approx. 6 seconds. The seconds can be seen counting down in the Hob display.

The Hob display shows *P*.

The Cookware displays show the following:

- *9* and a number indicate the selected quick parameter.
- Depending on the model:
  - £* and a number indicate the selected code of the selected quick parameter.

Other sensor controls light up.

The  *NFC icon* display lights up brightly.

- Touch *+* *Plus* or the Slider at the top right next to the Hob display repeatedly until the corresponding Cookware display shows the following: *903*
- Touch  *OK*.

Numbers will appear in the Hob display one after another, separated by a dash.

Example: *12 34* (model identifier KM 1234) – *1 23 45 67 89* (serial number)

## Displaying the software version

There must not be any cookware on the hob.

- Switch the hob off.

- Touch  *On/Off* for approx. 6 seconds. The seconds can be seen counting down in the Hob display.

The Hob display shows *P*.

The Cookware displays show the following:

- *9* and a number indicate the selected quick parameter.
- Depending on the model:
  - £* and a number indicate the selected code of the selected quick parameter.

Other sensor controls light up.

The  *NFC icon* display lights up brightly.

- Touch *+* *Plus* or the Slider at the top right next to the Hob display repeatedly until the corresponding Cookware display shows the following: *902*
- Touch  *OK*.

3 numbers appear in the Hob display:  
Example: *1.23* = software version 1.23.

## Software update

### Carrying out a software update

Information about the content and scope of an update is provided in the Miele app.

1. Your hob is networked with your home network
2. The Hob display shows *UP*.

- Touch *+* *Plus*.

The Hob display shows *UP* and shortly afterwards *£ \_ ] ... [ \_ ] ... [ \_ ] ...*

When the hob switches off, the update is complete. You can use your hob as usual again.

# Adjusting settings

---

## Postponing the software update

Information about the content and scope of an update is provided in the Miele app.

However, Miele recommends installing the updates as soon as possible.

1. Your hob is networked with your home network
2. The Hob display shows *UP*.

■ Touch — *Minus*.

You can use your hob as usual.

If you restart your hob and no residual heat indicators light up, you will be prompted to perform the update again.

## Switching off the software update

However, Miele recommends installing updates.

■ To deactivate updates permanently, go to the Miele app or contact Miele Customer Service.

## Safety notes on cleaning and care

 Risk of burning due to hot surfaces.

All parts of the hob may be hot after use.

Switch the hob off.

Allow the hob to cool down before cleaning it.

All surfaces could be discoloured or damaged if unsuitable cleaning agents are used or if residues from suitable cleaning agents are heated on the hob.

Allow the surfaces to cool down before cleaning the hob.

Remove all cleaning agent residues immediately.

Never use abrasive sponges or cleaning agents.

Using washing-up liquid will not remove all soiling and residues. An invisible film can develop that can lead to discolouration of the ceramic glass surface. This discolouration cannot be removed.

Clean the glass ceramic surface regularly with a proprietary ceramic glass cleaner.

▶ Do not use a steam cleaner to clean the hob.

▶ Do not use pointed objects for cleaning.

## Cleaning the ceramic glass surfaces

### Removing light soiling

- Clean the entire ceramic surface of the hob with a damp, soft cloth and a solution of water and a little washing-up liquid. Please follow the cleaning agent manufacturer's instructions.

### Removing stubborn soiling

- Remove any coarse soiling with a damp cleaning cloth and more stubborn soiling with a glass scraper.
- Clean the ceramic surface with the Miele ceramic and stainless steel cleaner or with a proprietary ceramic glass cleaner. Please follow the cleaning agent manufacturer's instructions.

### Finishing the cleaning process

- Remove all cleaning agent residues with a damp cleaning cloth.
- Dry the ceramic surface of the hob after cleaning.

## Unsuitable cleaning agents

To avoid damaging the surfaces of the appliance, do not use:

- Cleaning agents containing soda, alkalines, ammonia, acids or chlorides
- Stain and rust removers
- Abrasive cleaning agents, e.g. powder cleaners and cream cleaners
- Cleaning agents containing solvents
- Dishwasher cleaning agents
- Grill and oven sprays
- Hard, abrasive brushes
- Eraser stain remover blocks
- Sponges

# Troubleshooting

Many malfunctions and faults can be easily remedied. You can save time and money in many cases, as you do not need to contact Customer Service.

More information to help you remedy faults yourself can be found at [www.miele.de/support/customer-assistance](http://www.miele.de/support/customer-assistance).



## Messages in the display

Problem	Cause and remedy
<b>COL flashes alternately with the set/reduced power in the Cookware display</b>	<p>The cookware has been placed in an unfavourable position.</p> <p>The cookware could not be clearly assigned to a control element.</p> <p>The cookware is too close together.</p> <p>The cookware is too close together and the power levels are set to very different levels.</p> <ul style="list-style-type: none"><li>■ Reposition the cookware. Move the items of cookware one after the other, not all at the same time.</li></ul>
<b>After the hob has been switched on, or after touching a sensor control, LOC appears alternately with On in the Hob display for a few seconds.</b>	<p>The system lock is activated.</p> <ul style="list-style-type: none"><li>■ Deactivate the system lock.</li></ul>
	<p>The keypad lock is activated.</p> <ul style="list-style-type: none"><li>■ Deactivate the keypad lock.</li></ul>
<b>After the hob has been switched on, dE briefly appears alternately with On in the Hob display. The cookware does not heat up.</b>	<p>The hob is in demo mode.</p> <ul style="list-style-type: none"><li>■ Deactivate demo mode.</li></ul>
<b>⌋ flashes in the Hob display and the hob switches off automatically.</b>	<p>One or more of the sensor controls are covered, e.g. by finger contact, food boiling over or an object.</p> <ul style="list-style-type: none"><li>■ Remove the soiling or obstruction.</li></ul>
<b>The Hob display shows UP</b>	<p>A software update is available for your hob. Touch — <i>Minus</i> to postpone the update. Perform the update at the next possible time or switch off the updates permanently.</p>

Problem	Cause and remedy
<i>Err</i> flashes alternately with 044 in the Hob display.	<p>The overheating protection mechanism has been activated.</p> <ul style="list-style-type: none"> <li>■ Allow the hob to cool down.</li> <li>■ Rectify the causes of the overheating.</li> <li>■ Check that the hob is working.</li> <li>■ If this fault message continues to appear in the display, contact the Customer Service Department.</li> </ul>
<i>Err</i> flashes alternately with 710, 711, 712 or 713 in the Hob display.	<p>The hob is incorrectly connected.</p> <ul style="list-style-type: none"> <li>■ Disconnect the hob from the mains power supply.</li> <li>■ Contact the Customer Service Department. The hob must be connected to the mains according to the wiring diagram.</li> </ul>
<i>Err</i> alternately with 726, 727, 728 or 729 in the Hob display.	<p>The fan is blocked or defective.</p> <ul style="list-style-type: none"> <li>■ Make sure it has not been blocked by an object.</li> <li>■ Remove the obstruction.</li> <li>■ If this fault message continues to appear in the Hob display, contact Customer Service.</li> </ul>
A message not listed in this table is appearing on the Hob display.	<p>There is an electronic module fault.</p> <ul style="list-style-type: none"> <li>■ Disconnect the power supply to the hob for approx. 1 minute.</li> <li>■ If the problem persists after the power supply has been restored, please contact the Customer Service Department.</li> </ul>

## Unexpected behaviour

Problem	Cause and remedy
When you place an item of cookware on the hob, the corresponding slide control does not appear.	<p>The cookware cannot be detected in this position because it is very small.</p> <ul style="list-style-type: none"> <li>■ Reposition the cookware. If it is still not detected, use a different item of cookware.</li> </ul>
	<p>The cookware is unsuitable.</p> <ul style="list-style-type: none"> <li>■ Use suitable cookware.</li> </ul>
You re-position a pan and the set power level starts to flash.	<p>The pan cannot be detected.</p> <ul style="list-style-type: none"> <li>■ Touch the flashing power level.</li> <li>■ If the power level continues to flash, re-position the pan.</li> </ul>

# Troubleshooting

Problem	Cause and remedy
<p><b>You re-position a pot or a pan, the set power level goes out and 0 lights up.</b></p>	<p>The pan cannot be detected.</p> <ul style="list-style-type: none"> <li>■ Reset the power level.</li> </ul>
<p><b>Power level 9 is automatically reduced if you also set power level 9 for the connected cooking zone.</b></p>	<p>Operating both zones at power level 9 exceeds the permitted maximum power for the two zones.</p> <ul style="list-style-type: none"> <li>■ Use a different cooking zone.</li> </ul>
<p><b>An area or the whole hob switches off automatically.</b></p>	<p>It has been operated for too long.</p> <ul style="list-style-type: none"> <li>■ Switch the hob or area on again.</li> </ul> <p>The overheating protection mechanism has been activated.</p> <ul style="list-style-type: none"> <li>■ Allow the hob to cool down.</li> <li>■ Rectify the causes of the overheating.</li> <li>■ Check that the hob is working.</li> <li>■ If the problem occurs again, contact the Customer Service Department.</li> </ul>
<p><b>The cooking zone is not working in the usual way with the set power level.</b></p>	<p>The overheating protection mechanism has been activated.</p> <ul style="list-style-type: none"> <li>■ Allow the hob to cool down.</li> <li>■ Rectify the causes of the overheating.</li> <li>■ Check that the hob is working.</li> <li>■ If the problem occurs again, contact the Customer Service Department.</li> </ul>
<p><b>The Booster level has deactivated early automatically.</b></p>	<p>The overheating protection mechanism has been activated.</p> <ul style="list-style-type: none"> <li>■ Allow the hob to cool down.</li> <li>■ Rectify the causes of the overheating.</li> <li>■ Check that the hob is working.</li> <li>■ If the problem occurs again, contact the Customer Service Department.</li> </ul>

## Unsatisfactory results

Problem	Cause and remedy
<p><b>The food in the cookware does not heat up when the auto heat-up is switched on.</b></p>	<p>Large quantities of food are being cooked.</p> <ul style="list-style-type: none"> <li>■ Start cooking at the highest power level and then switch back manually.</li> </ul>
	<p>The cookware is not conducting heat properly.</p> <ul style="list-style-type: none"> <li>■ Use different cookware that is able to better conduct heat.</li> </ul>
<p><b>In comparable cooking and frying processes there are slight differences in cooking durations and browning.</b></p>	<p>This is not a fault.</p> <p>The pan base material and the positions of the pans on the hob affect the power of the induction coils. This in turn affects the cooking behaviour.</p>
<p><b>Cookware positions are not detected and/or there is uneven heat distribution in the cookware.</b></p>	<p>The cookware is not in the optimum position.</p> <ul style="list-style-type: none"> <li>■ Position the cookware according to the instructions.</li> <li>■ If you continue to have unsatisfactory cooking results, set the poor cookware position indicator (P24) in the settings.</li> </ul> <p>The detection of unfavourable cookware positions is more finely tuned. The hob now also reports unfavourable cookware positions in addition to incompatible cookware positions.</p>

# Troubleshooting

## General problems or technical faults

Problem	Cause and remedy
<p><b>The hob cannot be switched on.</b></p>	<p>There is no power to the hob.</p> <ul style="list-style-type: none"> <li>■ Check whether the circuit breaker has tripped. Contact a qualified electrician or the Miele Customer Service Department (for the minimum fuse rating, see data plate).</li> </ul> <p>There may be a technical fault.</p> <ul style="list-style-type: none"> <li>■ Disconnect the hob from the electricity supply for approx. 1 minute. To do this:               <ul style="list-style-type: none"> <li>– Trip the relevant mains fuse or screw the fine-wire fuse out completely, or</li> <li>– Switch off at the residual current device</li> </ul> </li> <li>■ If the hob will still not turn on after resetting the trip switch in the fuse box or the residual current device, contact a qualified electrician or the Miele Customer Service Department.</li> </ul>
<p><b>A smell and vapours are given off when the new hob is being used.</b></p>	<p>The metal components have a protective coating. When the hob is used for the first time, this causes a smell and possibly also vapour. The material from which the induction coils are made also gives off an odour in the first few hours of operation. With each subsequent use, the odour is reduced until it disappears completely. The odour and any vapours given off do not indicate a faulty connection or appliance and they are not hazardous to health.</p>
<p><b>An operating noise can be heard after the hob has been switched off.</b></p>	<p>The cooling fan runs until the hob has cooled down and then switches off automatically.</p>
<p><b>Various problems with settings, e.g. problems with networking</b></p>	<p>Changes to settings can lead to conflicts with each other.</p> <p>Fluctuations in the WiFi signal can lead to conflicts.</p> <div style="border: 1px solid gray; padding: 5px; margin: 5px 0;"> <p>If you reset settings to factory defaults, existing settings will be deleted. Document existing settings to restore existing settings.</p> </div> <ul style="list-style-type: none"> <li>■ Reset the settings to the factory defaults.</li> </ul> <p>You can reset all settings or just individual settings such as the WiFi settings.</p>

Information to help you rectify faults yourself and about Miele spare parts can be found at [www.miele.com/service](http://www.miele.com/service).

### Contact in the event of a fault

In the event of a fault which you cannot remedy yourself, please contact your Miele dealer or Miele Customer Service.

You can book a Miele Customer Service call-out online at [www.miele.com/service](http://www.miele.com/service).

Contact information for Miele Customer Service can be found at the end of this document.

Please quote the model identifier and serial number of your appliance (SN) when contacting Miele Customer Service. This information can be found on the data plate.

### Data plate

Stick the extra data plate supplied with the appliance here. Make sure that the model identifier matches the one specified on the back cover of this document.

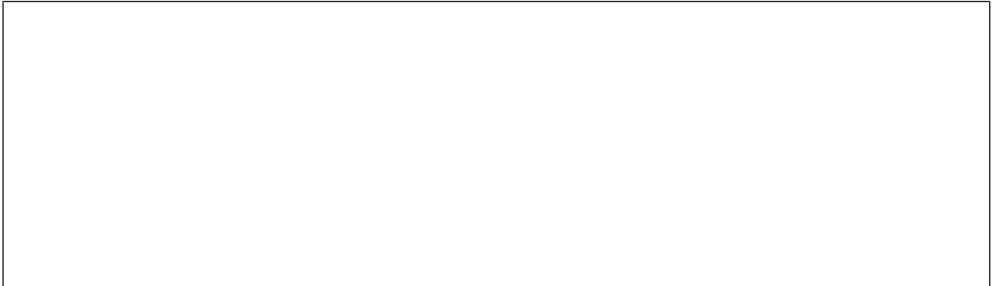

### Warranty

For information on the appliance warranty specific to your country please contact Miele. See back cover for address.

In the UK, your appliance warranty is valid for 2 years from the date of purchase. However, you must activate your cover by calling 0330 160 6640 or registering online at [www.miele.co.uk](http://www.miele.co.uk).

# Technical data

## Technical data

ISM band frequency	2,400 GHz – 2,4835 GHz
RFID/NFC frequency	13,56 Mhz
WiFi transmission power	≤ 100 mW
RFID/NFC transmission power	≤ 100 mW
BTLE transmission power	≤ 10 mW
Power rating in off mode	≤ 0,5 W
Power rating in networked standby	≤ 2 W
Time until automatic switch to off mode	10 Min.
Time until automatic switch to networked standby	10 Min.

## Product data sheets

The following product data sheets apply to the models described in these operating and installation instructions.

### Information for domestic electric hobs

In acc. with regulation (EU) No. 66/2014

MIELE	
Model name/identifier	KM 8765 FL Diamond
Type of hob	built-in
Number of cooking zones and/or areas	1
For circular cooking zones: diameter of useful surface area/cooking zone For non-circular cooking zones or areas: length and width of useful surface area per electric cooking zone or area	1. = 570 x 380 mm
Energy consumption per cooking zone or area calculated per kg (EC <sub>electric cooking</sub> )	1. = 184,8 Wh/kg
Energy consumption for the hob calculated per kg (EC <sub>electric hob</sub> )	184,8 Wh/kg
- Full area / Can be selected freely / Induction	

### Information for domestic electric hobs

In acc. with regulation (EU) No. 66/2014

MIELE	
Model name/identifier	KM 8885-2 FL Diamond&MSense
Type of hob	built-in
Number of cooking zones and/or areas	1
For circular cooking zones: diameter of useful surface area/cooking zone For non-circular cooking zones or areas: length and width of useful surface area per electric cooking zone or area	1. = 740 x 380 mm
Energy consumption per cooking zone or area calculated per kg (EC <sub>electric cooking</sub> )	1. = 186,0 Wh/kg
Energy consumption for the hob calculated per kg (EC <sub>electric hob</sub> )	186,0 Wh/kg
- Full area / Can be selected freely / Induction	

## Information for domestic electric hobs

In acc. with regulation (EU) No. 66/2014

MIELE	
Model name/identifier	KM 8895-2 FL Diamond&MSense
Type of hob	built-in
Number of cooking zones and/or areas	1
For circular cooking zones: diameter of useful surface area/cooking zone For non-circular cooking zones or areas: length and width of useful surface area per electric cooking zone or area	1. = 870 x 380 mm
Energy consumption per cooking zone or area calculated per kg (EC <sub>electric cooking</sub> )	1. = 187,0 Wh/kg
Energy consumption for the hob calculated per kg (EC <sub>electric hob</sub> )	187,0 Wh/kg
- Full area / Can be selected freely / Induction	

## EU Conformity declaration

Miele hereby declares that this ceramic induction hob complies with Directive 2014/53/EU.

The complete text of the EU declaration of conformity is available from one of the following internet addresses:

# Technical data

---

- Products, Download from [www.miele.ie](http://www.miele.ie)
- For service, information, operating instructions etc: go to <https://miele.ie/manuals> and enter the name of the product or the serial number

## UK Conformity declaration

Miele hereby declares that this ceramic induction hob complies with UK Radio Equipment Regulations 2017, as amended.

The complete text of the UK declaration of conformity is available from one of the following internet addresses:

- Products, Download from [www.miele.co.uk](http://www.miele.co.uk)
- For service, information, operating instructions etc: go to <https://miele.co.uk/manuals> and enter the name of the product or the serial number

This **Statement of Compliance** confirms this Miele product fully complies with the **Product Security and Telecommunications Infrastructure (Security Requirements for Relevant Connectable Products) Regulations 2023**.

- 1) Household Appliance – Inductions hobs IC08-02W
- 2) Manufactured by: Miele & Cie KG,  
Carl Miele Street 29, 33332 Gutersloh Germany  
Imported by and contact point: Miele Company Ltd, Fairacres, Marcham Road,  
Abingdon, Oxon, OX14 ITW Great Britain
- 3) The defined support period at the time of first supply is 10 years
- 4) To report vulnerabilities and cybersecurity issues please contact: [psirt@miele.com](mailto:psirt@miele.com)
- 5) Signature   
Name: **Paul Wright**  
Company Position: **Head of Technical Management**  
Date of signature: **19th March 2024**  
Place of signature: **Abingdon, Oxfordshire**





## United Kingdom

Miele Co. Ltd., Fairacres, Marcham Road, Abingdon, Oxon, OX14 1TW  
Tel: 0330 160 6600, Internet: [www.miele.co.uk](http://www.miele.co.uk), E-mail: [info@miele.co.uk](mailto:info@miele.co.uk)

### Australia

Miele Australia Pty. Ltd.  
ACN 005 635 398  
ABN 96 005 635 398  
Level 4, 141 Camberwell Road  
Hawthorn East, VIC 3123  
Tel: 1300 464 353  
E-mail: [info@miele.com.au](mailto:info@miele.com.au)  
Internet: [www.miele.com.au](http://www.miele.com.au)

### China Mainland

Miele Electrical Appliances Co. Ltd.  
No. 82, Shimenyi Road, JingAn District  
Shanghai, China, P.R.C  
Post Code: 200040  
Phone: +86 21 6157 3500  
Fax: +86 21 6157 3511  
E-mail: [info@miele.cn](mailto:info@miele.cn)  
Internet: [www.miele.cn](http://www.miele.cn)

### Hong Kong, China

Miele (Hong Kong) Ltd.  
41/F - 4101, Manhattan Place  
23 Wang Tai Road  
Kowloon Bay, Hong Kong  
Tel: (852) 2610 1025  
Fax: (852) 3579 1404  
E-mail:  
[customerservices@miele.com.hk](mailto:customerservices@miele.com.hk)  
Website: [www.miele.hk](http://www.miele.hk)

### India

Miele India Pvt. Ltd.  
1st Floor, Copia Corporate Suites,  
Commercial Plot 9, Mathura Road,  
Jasola, New Delhi - 110025  
E-mail: [customercare@miele.in](mailto:customercare@miele.in)  
Website: [www.miele.in](http://www.miele.in)

### Ireland

Miele Ireland Ltd.  
2024 Bianconi Avenue  
Citywest Business Campus  
Dublin 24  
Tel: (01) 461 07 10  
Tel: (01) 461 07 97  
Fax: (01) 461 07 97  
E-mail: [info@miele.ie](mailto:info@miele.ie)  
Internet: [www.miele.ie](http://www.miele.ie)

### Malaysia

Miele Sdn Bhd  
Suite 12-2, Level 12  
Menara Sapura Kencana  
Petroleum  
Solaris Dutamas No. 1  
Jalan Dutamas 1  
50480 Kuala Lumpur, Malaysia  
Phone: +603-6209-0288  
Fax: +603-6205-3768

### New Zealand

Miele New Zealand Limited  
IRD 98 463 631  
8 College Hill  
Freemans Bay, Auckland 1011  
Tel: 0800 464 353  
E-mail: [customercare@miele.co.nz](mailto:customercare@miele.co.nz)  
Internet: [www.miele.co.nz](http://www.miele.co.nz)

### Singapore

Miele Pte. Ltd.  
29 Media Circle  
#11-04 ALICE@Mediapolis  
Singapore 138565  
Tel: +65 6735 1191  
Fax: +65 6735 1161  
E-mail: [info@miele.com.sg](mailto:info@miele.com.sg)  
Internet: [www.miele.sg](http://www.miele.sg)

### South Africa

Miele (Pty) Ltd.  
63 Peter Place, Bryanston 2194  
P.O. Box 69434, Bryanston 2021  
Tel: (011) 875 9000  
Fax: (011) 875 9035  
E-mail: [info@miele.co.za](mailto:info@miele.co.za)  
Internet: [www.miele.co.za](http://www.miele.co.za)

### Thailand

Miele Appliances Ltd.  
BHIRAJ TOWER at EmQuartier  
43rd Floor Unit 4301-4303  
689 Sukhumvit Road  
North Klongton Sub-District  
Vadhana District  
Bangkok 10110, Thailand

### United Arab Emirates

Miele Appliances Ltd.  
Showroom 1, Eiffel 1 Building  
Sheikh Zayed Road, Umm Al Sheif  
P.O. Box 114782 - Dubai  
Tel. +971 4 3044 999  
Fax. +971 4 3418 852  
800-MIELE (64353)  
E-mail: [info@miele.ae](mailto:info@miele.ae)  
Website: [www.miele.ae](http://www.miele.ae)

**Manufacturer:** Miele & Cie. KG, Carl-Miele-Straße 29, 33332 Gütersloh, Germany

KM 8765 FL Diamond, KM 8885-2 FL Diamond&MSense,  
KM 8895-2 FL Diamond&MSense