

## OUTDOOR COMMERCIAL CANOPY INSTALLATION INSTRUCTIONS

**WARNING:** These products may represent a possible shock or fire hazard if improperly installed or attached in any way. Products should be installed in accordance with the owners manual, current electrical codes and/or the current National Electric Code (NEC).

**PARTS INCLUDED**

- (1) Outdoor Commercial Canopy
- (1) Mounting Plate
- (3) Wire nuts

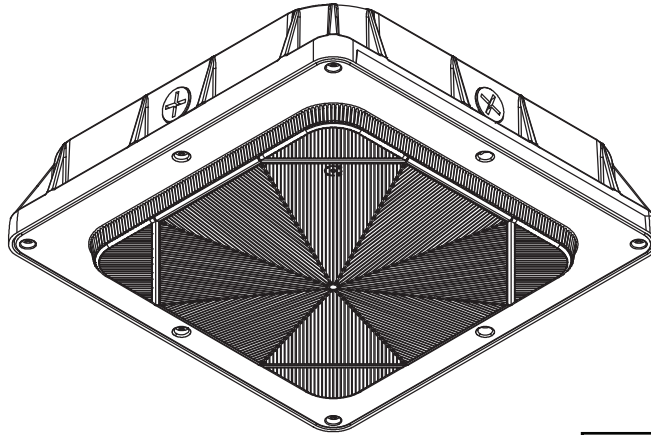

**CAUTION, IMPORTANT SAFETY INSTRUCTIONS** - Make sure the supply voltage is the same as the rated luminaire voltage. Do not install where marked operating temperatures exceed the ignition temperature of the hazardous atmosphere. Do not operate in ambient temperatures above those indicated on the luminaire nameplate. To avoid the risk of fire, explosion, or electric shock, this product should be installed, inspected and maintained by a qualified electrician only, in accordance with all applicable electrical codes. Be certain electrical power is OFF before and during installation and maintenance.

**Note:** Save these instructions for future reference.

For supply connections use wire rated for at least 90°C

**CAUTION:** Input 100-277VAC

**LIMITED WARRANTY**

This product is warranted to be free from defects in workmanship and materials for up to 5 years from date of purchase. If it fails to do so, please contact Feit Electric at [info@feit.com](mailto:info@feit.com) or call 1-866 326-BULB (2852) for instructions on replacement. Do not return the product to the store.

For comments please write to:  
Feit Electric  
Customer Service Department  
4901 Gregg Road, Pico Rivera, CA 90660

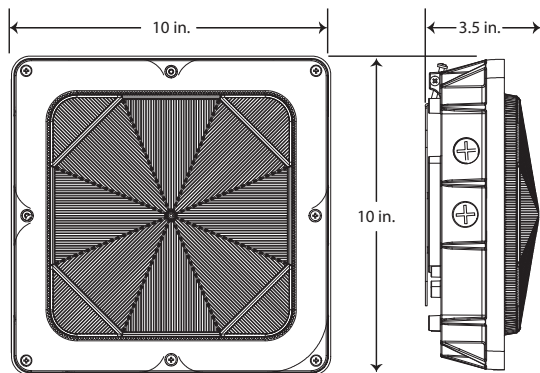

This device complies with part 15 of the FCC Rules. Operation is subject to the following two conditions: (1) This device may not cause harmful interference, and (2) this device must accept any interference received, including interference that may cause undesired operation. Note: This equipment has been tested and found to comply with the limits for a Class B digital device, pursuant to part 15 of the FCC Rules. These limits are designed to provide reasonable protection against harmful interference in a residential installation. This equipment generates, uses and can radiate radio frequency energy and, if not installed and used in accordance with the

instructions, may cause harmful interference to radio communications. However, there is no guarantee that interference will not occur in a particular installation. If this equipment does cause harmful interference to radio or television reception, which can be determined by turning the equipment off and on, the user is encouraged to try to correct the interference by one or more of the following measures: Reorient or relocate the receiving antenna. Increase the separation between the equipment and receiver. Connect the equipment into an outlet on a circuit different from that to which the receiver is connected. Consult the dealer or an experienced radio/TV technician for help.



**WARNING:** TURN OFF THE MAIN POWER AT THE CIRCUIT BREAKER BEFORE INSTALLING THE FIXTURE IN ORDER TO PREVENT POSSIBLE ELECTRIC SHOCK.

**WARNING:** This luminaire should be installed by qualified electrician. To avoid the risk of fire, explosion or electric shock, this product should be installed, inspected and maintained by a qualified electrician only, in accordance with all applicable electrical codes.

**To avoid electric shock:** Be certain electrical power is OFF before and during installation and maintenance. Luminaire must be connected to a wiring system with an equipment-grounding conductor.

Make sure the supply voltage is the same as the rated luminaire voltage. Do not operate in ambient temperatures above those indicated on the luminaire nameplate. Keep lens tightly closed when in operation.

### Pendant Mount Installation

1. Loosen screw "A" on the side of the canopy fixture and remove the mounting plate and rubber plug (Fig A).

Fig A.

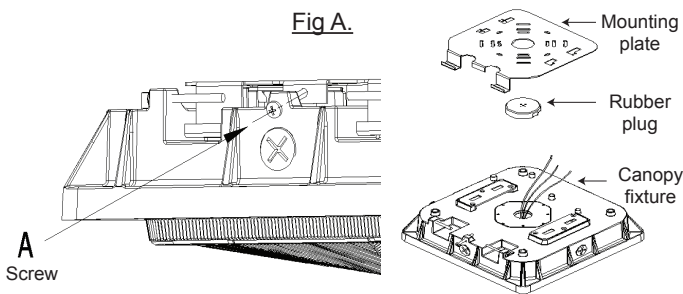

2. Make sure the power is off. Connect the power supply wires from the pendant rod to the fixture. Feed the wires into the fixture. (Fig B). **See wiring diagram.**

Fig B.

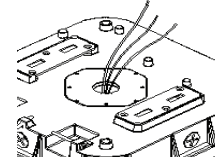

3. Connect and screw in the 3/4 inch pendant rod into the fixture (Fig C).

Fig C.

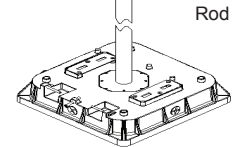

### Junction Mount Installation

1. Loosen screw "A" on the side of the canopy fixture and remove the mounting plate (Fig D).

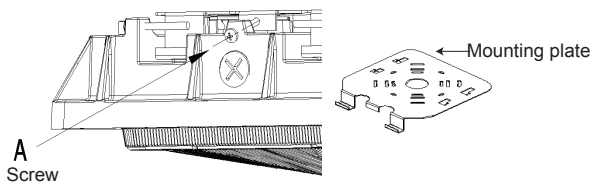

2. Make sure the power is off. Feed the power supply wires through the center of the mounting plate. Attach the mounting plate onto the junction box (Fig E).

Fig E.

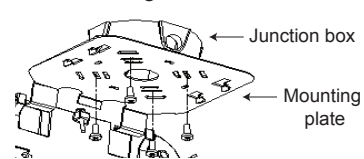

3. Hang the canopy fixture on the mounting plate and finish wiring (Fig F). **See wiring diagram.**

Fig F.

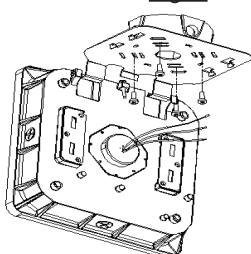

4. Feed the wires into the J-Box. Lock the canopy fixture towards the mounting plate hooks (Fig G).

Fig G.

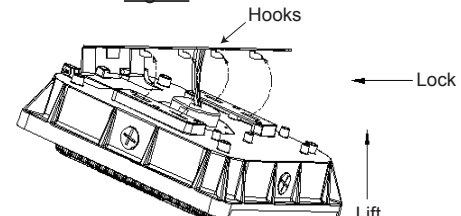

### Junction Mount Installation (continued)

- Once the canopy fixture is in the fixed position, fasten screw "A" to lock the fixture into place (Fig H).

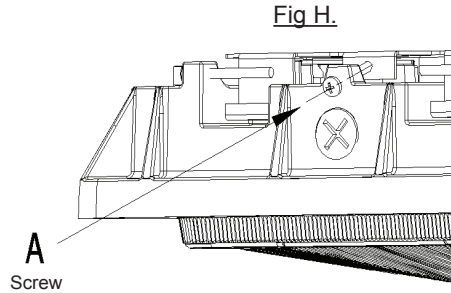

### Ceiling Mount Installation

- Loosen screw "A" on the side of canopy fixture and remove the mounting plate and set aside (Fig I).

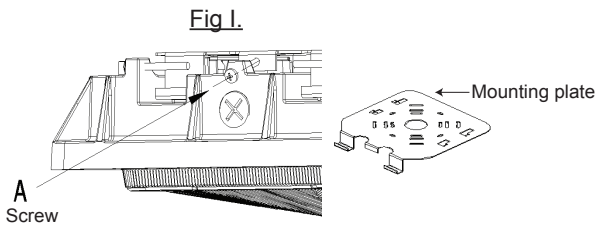

- Disassemble the canopy fixture by using a Philips screwdriver to loosen the 8 screws on the diffuser lens. Remove the diffuser lens from the canopy fixture, then remove the reflector (Fig J).

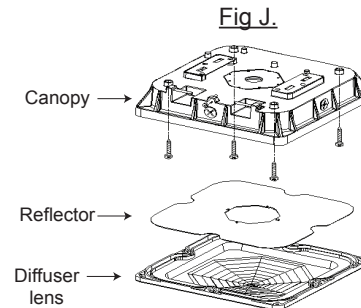

- Using a drill and drill-bit, drill out 4 holes on the canopy fixture for ceiling mount. Mount canopy onto the ceiling surface using 4 anchors and screws (not included) (Fig K).

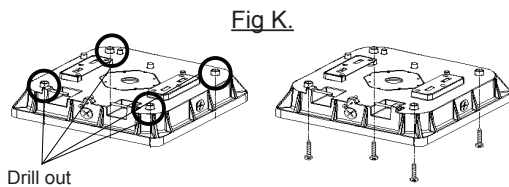

- Make sure power is off. Remove the 1/2 inch plug from the direction you intend to feed the conduit. Connect the power supply wires to the fixture (Fig L). See the wiring diagram below.

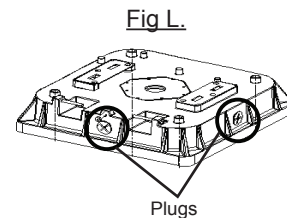

- Assemble the Reflector and Diffuser lens back onto the canopy fixture (Fig M).

