

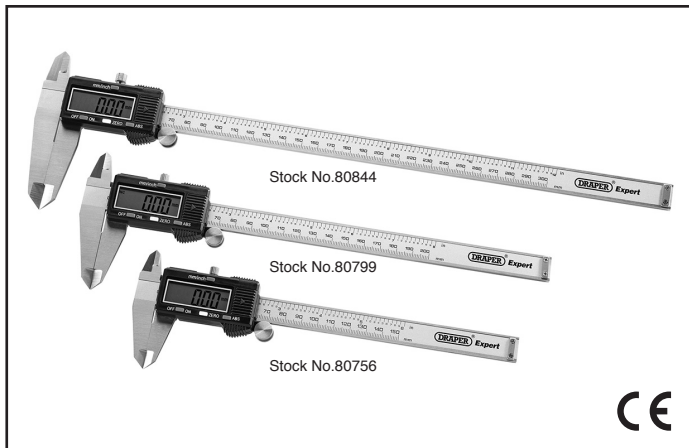

# DRAPER®

## DIGITAL CALIPER

80756/80799/80844



These instructions accompanying the product are the original instructions. This document is part of the product, keep it for the life of the product passing it on to any subsequent holder of the product. Read all these instructions before assembling, operating or maintaining this product.

This manual has been compiled by Draper Tools describing the purpose for which the product has been designed, and contains all the necessary information to ensure its correct and safe use. By following all the general safety instructions contained in this manual, it will ensure both product and operator safety, together with longer life of the product itself.

All photographs and drawings in this manual are supplied by Draper Tools to help illustrate the operation of the product.

Whilst every effort has been made to ensure the accuracy of information contained in this manual, the Draper Tools policy of continuous improvement determines the right to make modifications without prior warning.

# 1. TITLE PAGE

---

## 1.1 INTRODUCTION:

**USER MANUAL FOR: Digital caliper**

Stock No's: 80756, 80799, 80844.

Part No's: PVC150D/B, PVC200D/B, PVC300D/B.

## 1.2 REVISIONS:

**Date first published July 2017.**

---

---

---

---

As our user manuals are continually updated, users should make sure that they use the very latest version.

**Downloads are available from:** <http://drapertools.com/manuals>

Draper Tools Limited  
Hursley Road  
Chandler's Ford  
Eastleigh  
Hampshire  
SO53 1YF  
UK

**Website:** [drapertools.com](http://drapertools.com)

**Product Helpline:** +44 (0) 23 8049 4344

**General Fax:** +44 (0) 23 8026 0784

## 1.3 UNDERSTANDING THIS MANUALS SAFETY CONTENT:

**WARNING!** – Information that draws attention to the risk of injury or death.

**CAUTION!** – Information that draws attention to the risk of damage to the product or surroundings.

## 1.4 COPYRIGHT © NOTICE:

Copyright © Draper Tools Limited.

Permission is granted to reproduce this publication for personal and educational use only. Commercial copying, redistribution, hiring or lending is prohibited.

No part of this publication may be stored in a retrieval system or transmitted in any other form or means without written permission from Draper Tools Limited.

In all cases this copyright notice must remain intact.

---

## 2. CONTENTS

---

<b>1. TITLE PAGE</b>	
1.1 INTRODUCTION.....	2
1.2 REVISION HISTORY .....	2
1.3 UNDERSTANDING THIS MANUAL .....	2
1.4 COPYRIGHT NOTICE .....	2
<b>2. CONTENTS</b>	
2.1 CONTENTS .....	3
<b>3. GUARANTEE</b>	
3.1 GUARANTEE .....	4
<b>4. INTRODUCTION</b>	
4.1 SCOPE .....	4
4.2 SPECIFICATION .....	4
4.3 HANDLING AND STORAGE .....	4
<b>5. HEALTH AND SAFETY INFORMATION</b>	
5.1 SAFETY INSTRUCTIONS .....	4
<b>6. TECHNICAL DESCRIPTION</b>	
6.1 IDENTIFICATION .....	4
<b>7. OPERATING THE DIGITAL CALIPER</b>	
7.1 OPERATION AND USE .....	4-5
7.2 ABS FUNCTION 1 TO 4.....	5
7.3 CHANGING THE BATTERY.....	5
<b>8. EXPLANATION OF SYMBOLS</b>	
8.1 EXPLANATION OF SYMBOLS.....	5
<b>9. DISPOSAL</b>	
9.1 DISPOSAL .....	5
<b>DECLARATION OF CONFORMITY</b> .....	ENCLOSED

## 3. GUARANTEE

### 3.1 GUARANTEE

Draper tools have been carefully tested and inspected before shipment and are guaranteed to be free from defective materials and workmanship.

Should the tool develop a fault, please return the complete tool to your nearest distributor or contact:

**Draper Tools Limited, Chandler's Ford, Eastleigh, Hampshire, SO53 1YF. England.**

**Telephone Sales Desk: (023) 8049 4333 or:**

**Product Helpline (023) 8049 4344.**

A proof of purchase must be provided.

If upon inspection it is found that the fault occurring is due to defective materials or workmanship, repairs will be carried out free of charge. This guarantee period covering parts/labour is 12 months from the date of purchase except where tools are hired out when the guarantee period is 90 days from the date of purchase. The guarantee is extended to 24 months for parts only. This guarantee does not apply to normal wear and tear, nor does it cover any damage caused by misuse, careless or unsafe handling, alterations, accidents, or repairs attempted or made by any personnel other than the authorised Draper warranty repair agent.

Note: If the tool is found not to be within the terms of warranty, repairs and carriage charges will be quoted and made accordingly.

This guarantee applies in lieu of any other guarantee expressed or implied and variations of its terms are not authorised.

Your Draper guarantee is not effective unless you can produce upon request a dated receipt or invoice to verify your proof of purchase within the guarantee period.

Please note that this guarantee is an additional benefit and does not affect your statutory rights.

**Draper Tools Limited.**

## 4. INTRODUCTION

### 4.1 SCOPE

Metric & Imperial digital caliper featuring a large digital display, hardened & tempered stainless steel body.

### 4.2 SPECIFICATION

Stock No's. ....	80756.....	80799 .....	80844 .....
Part No's. ....	PVC150D/B.....	PVC200D/B .....	PVC300D/B .....
Measuring range .....	0-150mm / 0-6".....	0-200mm / 0-8" .....	0-300mm / 0-12" .....
Resolution .....	0.01mm / 0.0005".....	0.01mm / 0.0005" .....	0.01mm / 0.0005" .....
Repeatability .....	0.01mm / 0.0005".....	0.01mm / 0.0005" .....	0.01mm / 0.0005" .....
Accuracy.....	± 0.02mm / 0.001" .....	± 0.03mm / 0.001" .....	± 0.03mm / 0.001" .....
Maximum measuring speed .....	1.5m per second.....	1.5m per second .....	1.5m per second .....
	60" per second.....	60" per second .....	60" per second .....
Operating temperature .....	0°C – +40°C.....	0°C – +40°C .....	0°C – +40°C .....
Storage temperature .....	-20°C – +70°C .....	-20°C – +70°C .....	-20°C – +70°C .....
Battery .....	1 x LR44.....	1 x LR44 .....	1 x LR44 .....

### 4.3 HANDLING AND STORAGE

Do not drop the digital caliper as this can damage and shorten the life span of the unit.

Store in a dry location as damp conditions can damage the digital caliper.

## 5. HEALTH AND SAFETY INFORMATION

### 5.1 SAFETY INFORMATION

- Do not use if damaged.
- This digital caliper is a precision instrument, use with care. Do not drop or use excessive force.
- When not in use turn off and store in a dry safe place.
- Do not use in damp conditions. Do not get the caliper wet.
- Only use the caliper for the purpose its intended for.
- Do not apply any voltage to the caliper.

## 6. TECHNICAL DESCRIPTION

### 6.1 IDENTIFICATION

- |                             |                   |
|-----------------------------|-------------------|
| ① Step measure.             | ⑦ LCD display.    |
| ② Internal Measure.         | ⑧ Battery cover.  |
| ③ External measure.         | ⑨ ABS switch.     |
| ④ Depth measure.            | ⑩ Zero control.   |
| ⑤ Metric/Imperial selector. | ⑪ On/Off control. |
| ⑥ Locking screw.            |                   |

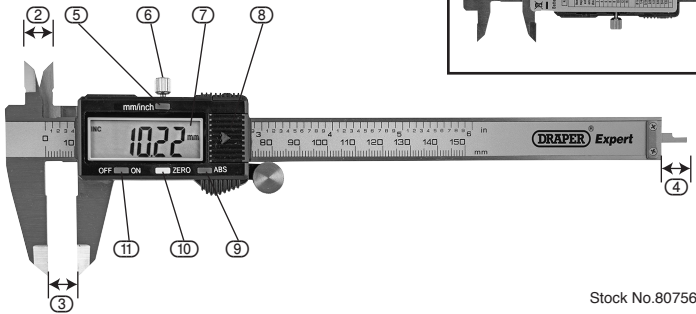
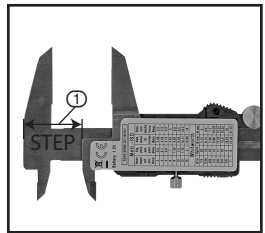

Stock No.80756

## 7. OPERATING THE DIGITAL CALIPER

**Note:** Before use ensure all surfaces which are to be measured are clean and free from burrs, oil and dirt.

### 7.1 OPERATION AND USE

Turn on the digital caliper and wait for a few seconds before sliding the main body.

Ensure the locking screw (6) is loosened off.

Close the caliper.

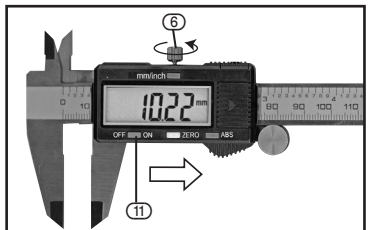

## 7. OPERATING THE DIGITAL CALIPER

A zero can be obtained at any point along the caliper by pressing the zero button (10).



As required press the mm/inch button (5) to switch between metric and imperial measurements.

### 7.2 ABS FUNCTION 1 TO 4

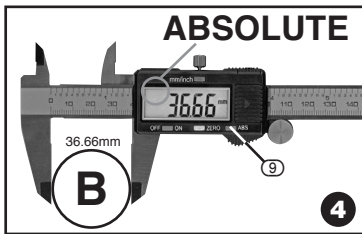
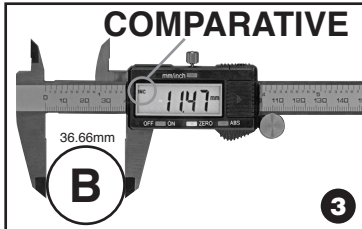
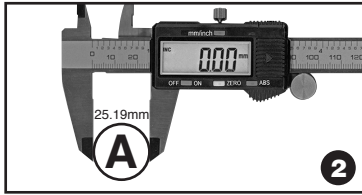
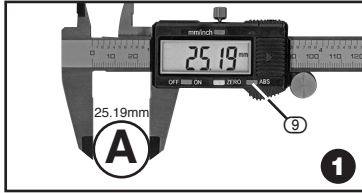

- Press the ABS button (9) to switch between Absolute & Comparative measuring mode.
- In Absolute measuring mode (no indication of 'INC' on the LCD) measures object in the standard way.

- To change to comparative measuring mode press 'ABS' to switch mode (INC indicator appears on the LCD) which shows that it is ready to measure dimensions referring to this zero point, so the readout now displays zero.

- Measure object B. The readout will show the comparative dimension to the object A zero point that is to say the difference between the dimensions of object A & B.

- While in comparative measuring mode press 'ABS' button again. The display will revert back to absolute measuring mode.

### 7.3 CHANGING THE BATTERY:

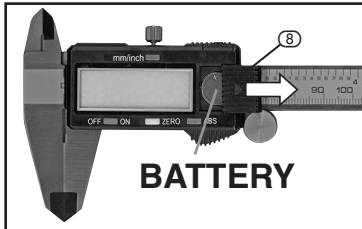

To replace the battery slide the battery cover (8) to the right of the digital display and carefully remove the LR44 battery and replace.

Note: A battery may be supplied in the unit already which may have gone flat. This is placed during production for testing purposes. It may be necessary to replace with the battery supplied loose in the box.

## 8. EXPLANATION OF SYMBOLS

### 8.1 EXPLANATION OF SYMBOLS



Do not dispose of WEEE\* unsorted municipal waste.

## 9. DISPOSAL

### 9.1 DISPOSAL

- At the end of the machine's working life, or when it can no longer be repaired, ensure that it is disposed of according to national regulations.
- Contact your local authority for details of collection schemes in your area.

In all circumstances:

- Do not dispose of power tools with domestic waste.
- Do not incinerate.
- Do not abandon in the environment.
- Do not dispose of WEEE\* as unsorted municipal waste.



\* Waste Electrical & Electronic Equipment.

## CONTACTS

Draper Tools Limited, Hursley Road,  
Chandler's Ford, Eastleigh, Hampshire. SO53 1YF. U.K.

Helpline: (023) 8049 4344

Sales Desk: (023) 8049 4333

Internet: [drapertools.com](http://drapertools.com)

E-mail: [sales@drapertools.com](mailto:sales@drapertools.com)

General Enquiries: (023) 8026 6355

Service/Warranty Repair Agent:

For aftersales servicing or warranty repairs, please contact the Draper Tools Helpline for details of an agent in your local area.

YOUR DRAPER STOCKIST

RDMC0817

©Published by Draper Tools Limited.

No part of this publication may be reproduced, stored in a retrieval system or transmitted in any form or by any means, electronic, mechanical photocopying, recording or otherwise without prior permission in writing from Draper Tools Ltd.