

SENCOR®

Let's live!

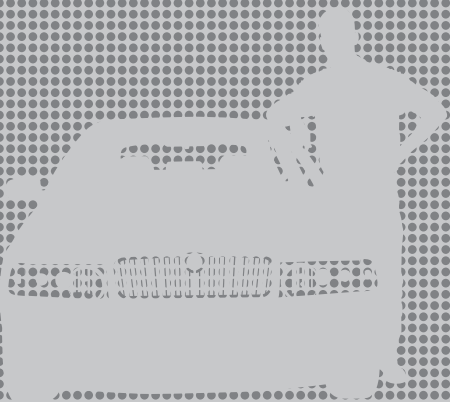

**CAMERA
KAMERA
KAMERA
KAMERA
KAMERA
SCR 2100**

**USER'S MANUAL
NÁVOD K OBSLUZE
NÁVOD NA OBSLUHU
HASZNÁLATI ÚTMUTATÓ
INSTRUKCJA OBSŁUGI**

EN CZ SK HU PL



1. Important safety instructions

Please read this user's manual carefully before using the device. It contains important information concerning safety, use and troubleshooting. Keep the manual in a safe place for future reference. Should you sell or give the device to a third party, include the user's manual to ensure the new owner can also become familiar with the device.

Warning

- Protect the display against damage.
- Do not use force to connect the USB. Always make sure you are connecting the USB cable with the device off.
- Do not insert connectors into the USB port other than the specified USB connector with the relevant port size.
- Handle the display with care to prevent damage.
- Protect the device against impacts. Do not expose the device to extreme temperatures, direct sunlight etc.
- When installing the device, degrease the mounting area on the glass and make sure the mount is fixed firmly so that the camera does not fall.
- Insert the SD card carefully, do not insert the card with force. Make sure the device is switched off before inserting the microSD card.
- Due to a wide range of microSD cards on the market, it is not possible to guarantee full compatibility with all microSD cards available.
- Do not expose the device or accessories to dripping or spraying water. Protect against moisture, dust and impurities. Do not place any containers with water on the device, for example, vases.
- Do not expose the device to sources of heat, for example, sunlight. Do not set the device on or near an open fire, for example, a candle.
- Use a dry towel for cleaning. Under no circumstances should benzene, thinner, ammonia or other similar substances be used.

2. Device and controls

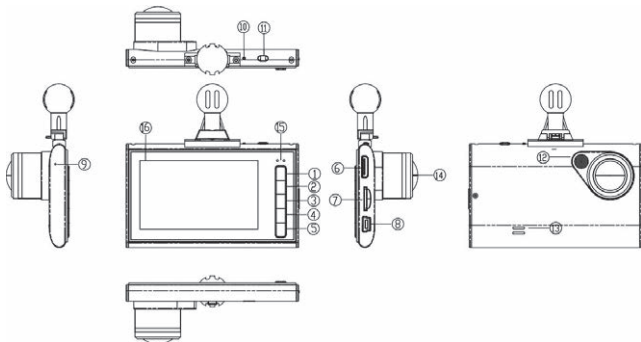

- 1) **MENU button** – press the button once to configure the video camera/ camera/playback, press twice to configure the device.
- 2) **UP button** – Up function in menu and settings, mutes the microphone during the recording process, Previous function in browsing mode
- 3) **REC/OK button** – REC recording in ready mode (card inserted, display on), OK function in menu and settings, PLAY/PAUSE function in browsing mode
- 4) **DOWN button** – Down function in menu and settings, locks the recorded file in recording mode, with playback paused (PAUSE), it displays an overview of files
- 5) **MODE button** – switching between operation modes
Photo-Recording-Playback, turns off display during the recording process
- 6) **HDMI out** TV connection for playback on TV – with an HDMI cable connected, the display on the device is switched off and the device goes into Playback mode

7) **MicroSD memory card slot**

- Inserting the card: insert the card carefully INTO THE SWITCHED OFF DEVICE in the proper direction according to the image on the device (label side facing the display, gold contact pins facing frontward and inside the device, with the asymmetrical slot facing down). Insert the card, for example, using your fingernail about 1 mm under the surface until you here a click. The card will fall into place upon release.
- Card removal: Push the card in, for example, using your fingernail about 1 mm under the surface until you here a click. When releasing the card from its compartment, hold on to it to prevent it from jumping out.

Notes:

- a) a quality card with a fast writing speed, at lease class 7, and suitable capacity shall be used for recording. Determine which card capacity best suits your needs before purchasing, a card with a small capacity can quickly become full with standard recording and locked files. We recommend at least 2GB. The maximum capacity supported is 32 GB. The recording can be affected by the specified speed class, but also by an even speed throughout the entire card memory.
- b) despite maximum effort to provide compatibility, we cannot guarantee support and smooth functionality with all devices on the market. If a feature or recording on the card does not meet your expectations, format the card in the computer and then in the device. If this does not improve functionality, use a different card, preferably a faster one.



NOTICE: both the inserted card and device memory use technology, which is sensitive to higher temperatures, or temperature shocks. Avoid leaving these memories exposed to higher temperatures (e.g. behind a car window) and do not expose to temperature shocks (e.g. in the winter). This could result in temporary or permanent damage to recordings found in the memory.

- 8) **USB port** – power and PC connection
- 9) **Microphone** – if available for use, the microphone records audio from the car cabin to the file
- 10) **RESET button** – press the button shortly to troubleshoot non-standard situations, when the device is unresponsive, even though it is charged
- 11) **On/Off button** – press the button shortly to turn the device on and hold the button longer to turn the device off. Short press = Standby mode
- 12) **IR lamp** – no function
- 13) **Speaker**
- 14) **Lens**
- 15) **Indicators** (charging = blue, status = red)
- 16) **Screen**

2.1. Glass mount

Carefully insert the device via the small track all the way until the lock attached the wind shield, or other suitable smooth surface, clicks.

Installing the mount to the car windscreen (if the piston is still equipped with a soft transport wrap, remove it prior to installing):

Release the soft mount piston (lift lever in the direction away from the piston). Select a location to mount the camera that does not block the driver's view. Apply the soft piston to the smooth, clean and degreased glass surface inside the car cabin. Lift the lifting lever all the way to the mount body. The soft piston creates suction that provides a reliable grip of the camera in its place. Slide the camera onto the mount (via rail). Loosen the tightening joint nut slightly and adjust the camera direction. Gently tighten the nut. Perform several test recordings at various resolutions and camera positions to ensure the end result meets your expectations. After you have checked the recordings, gently tighten the camera joint nut.



NOTICE: do not use excess force when handling the mount and camera, both parts are very light and are not expose to mechanical load during use.

2.2. Battery and charging instructions

Battery charged indicator:



Full



Almost full



Weak (a message reading the battery is low will appear before the device is switched off)

Charging methods: car adapter, PC USB slot, external power adapter (sold separately).



Warning: use a 5V power source only, otherwise you can damage the device.

Upon connecting the device to the car outlet and starting the ignition, the device will switch on and begin to record once the key is set to “Accessories” and the recording process is stopped when the key is removed from the ignition. The blue indicator goes off as soon as the battery is charged and the device is only in operating mode and not charging. The full charging cycle of an empty battery lasts up to 180 minutes.

2.3. USB modes

When the USB cable is connected to the PC and the device is switched on, besides charging, a menu will also appear with the following two options. Choose one:



- 1) Mass Storage – until the cable is disconnected from the computer, you can only read files on the card when it is inserted into the device. The device cannot be controlled via buttons, with the exception of the power button. Files are stored according to the data in the DCIM directory.
- 2) PC-camera – standard Windows camera interface for applications that support this feature (e.g. Skype)

2.4. Start-up, warm-up



1. Charge the device outside of car, press the On/Off button shortly to activate the device and follow the instructions in the manual to setup the device to meet your needs. At the end of the initial procedure, switch the device off by holding down the On/Off button (up to 3s).
2. Install the camera and mount to a suitable place on the wind shield and manually activate the camera connect to power supply for automatic activation.
3. If activated manually, you have to manually switch off the camera after the recording sequence is complete (not required if you auto-off is enabled).

2.5. Operating modes and use

MODE button for mode select

1. Press On/Off to turn on the device, the red indicator will light up and the intro screen will be displayed with the status icons and indicators. If the power supply is connected (e.g. in the car), the camera will immediately begin to record, in which case you can press REC/OK to stop the recording process.
2. Press MODE to toggle between video mode (camera) , and photo mode (Photo)  and browsing through previously captured recordings. Action icons are displayed in the top left corner of the screen.

Recording and video settings

Press REC/OK in Camera mode () to start recording. The  icon will slowly begin to flash in the top left corner of the screen, the red status indicator above the MENU button will also begin to flash. This status indicator, informing you of an active recording process, flashes even if the screen is turned off in standby mode.

Press REC/OK again to stop recording, the icon and indicators no longer flash.

Note: if the screen is deactivated in standby mode, the first press of a button activates the screen, pressing the button again then performs the desired action.

Audio recording can be turned on/off at any time during the recording process by pressing UP (icon with crossed microphone), pressing DOWN locks the file for archiving purposes, pressing MODE turns off the display. The device settings cannot be adjusted during an active recording process.

Parameter settings (MENU)

Press MENU once to navigate to mode setup, twice to access device settings.

Press again to exit both modes back to operating mode. The OK button is used to confirm options, select UP/DOWN, confirm again and return by pressing OK.

- Resolution: 1080FHD (1920×1080, 24 fps, 16:9), 1080P (1440×1080, 30 fps, 4:3), 720P (1280×720, 30 fps, 16:9), 480P (640×480, 30 fps, 4:3).
- Loop: OFF/3 min/5 min/10 min – the duration of each segment in a single file before a new file is created. Once the card memory is full, the oldest files are replaced with newer files.
- Exposure: EV -2.0 -5/3 -4/3 -1.0 -2/3 -1/3 +0.0 +1/3 +2/3 +1.0 +4/3 +5/3 +2.0
- Motion detection: Off/On – recording activates automatically when motion is detected in the scene (moving car) and stops after about 10 s when motion is no longer detected.
- Audio recording: Off/On – audio from the cabin is recorded via integrated microphone only if Audio is enabled.
- Time stamp: Off/On – the system date and time is recorded to the video if this option is enabled. Do not forget to set the date and time!
- G-Sensor: Off/Low/Medium/High – based on the configured sensitivity, the integrated accelerator ensures the given file is locked against being automatically deleted when a limit value is exceeded (shock, accident). Check the sensitivity in your application to ensure it does not unnecessarily mark files as locked even if it only concerns a common state (bumps on the road, railway crossings, and similar). The sensor can also be disabled.

Capturing photos and photo settings

Press REC/OK in Photo mode ( icon) to take a photo. The picture will stop for about 1 second to display the captured snapshot and the photo is stored to the card. The preview period can also be extended in settings.



Parameter settings (MENU)

Press MENU once to navigate to mode setup, twice to access device settings.

Press again to exit both modes back to operating mode. The OK button is used to confirm options, select UP/DOWN, confirm again and return by pressing OK.

- Photo settings: Single/2s timer/5s timer/10s timer – with an active timer (delayed shot), the device counts down the remaining time
- Resolution: 12M (4000×3000) / 10M (3648×2736) / 8M (3264×2448) / 5M (2592×1944) / 3M (2048×1536). Higher resolutions are interpolated.
- Sequence: Off/On – up to 5 snapshots captured with one press of the OK button.
- Quality: High/Standard/Economy – a higher compression level results in a smaller file size and reduces the level of detail
- Sharpness: Strong/Standard/Weak – increasing the sharpness of photos results in highlighting details
- White balance: Auto/Daylight/Cloudy/Light bulb/Fluorescent Lamp – changing the automatic white balance settings reduces colour changes caused by lighting in the scene, however, it shall be configured with consideration to ensure the image remains natural
- Colour: Colour/Black & White/Sepia
- ISO: Auto/100/200/400
- Exposure: EV -2.0 -5/3 -4/3 -1.0 -2/3 -1/3 +0.0 +1/3 +2/3 +1.0 +4/3 +5/3 +2.0
- Stabilizer: Off/On – helps reduce vibrations when taking long-exposure photos
- Quick Look: Off/2s/5s – keeping the captured photo for a certain period of time on the display even after being saved to the card.
- Time stamp: Off/Date/(Date/Time) – enter the time identification of the snapshot

Browsing and browsing settings

When the device is in Browsing mode ( icon for video recording and  icon for taking photos), the first file (video recording or photo) is always the first prepared to be displayed. Press DOWN to display previews for other files. Press UP/DOWN to browse through the files and press OK to confirm your selection. If the selected file is a video recording, the file can be played by pressing OK and press UP/DOWN to adjust the volume of the recorded sound. Press OK again to stop playback of the recording.

Delete

The file being viewed in playback mode can be deleted. Press MENU and select the DELETE option. Choose whether to delete one file (Delete current) or all video files and photos (Delete all) from the following menu. Press OK to confirm your choice or Cancel to exit the delete options.

File lock

A file can be protected against system or manual deletion in playback mode. Press MENU and select the LOCK option. Select an action from the following menu: Lock current/Unlock current/Lock all/Unlock all. Locked files are protected against being deleted, however, formatting the card deletes all contents regardless of whether or not files were locked.

To delete only some locked files, you first have to unlock these and then delete them. System-locked files (G-sensor feedback) are deleted in a similar way, they must first be unlocked.

Device settings

Press MENU twice to navigate to the device settings. Press again to return to operating mode. The OK button is used to confirm options, select UP/DOWN, confirm again and return by pressing OK.

- Parking mode – see description further.
- Date/Time: Press MENU to toggle between settings. Besides numerical values, you can also change the display method: YY/MM/DD, MM/DD/YY, DD/MM/YY.
- Auto-Off: Off/1 min/2 min – determines the idle time after which the device automatically switches off to save the battery. The OFF option disables the Auto-Off function.
- Button sounds: Off/On
- Language: select a language option.
- Frequency: 50 Hz/60 Hz – choose to reduce flashing caused by light sources.

- **Format:** Formats the memory card after informing the user they are about to lose all data. Proceed with caution as records cannot be recovered after formatting the memory card. Note: formatting the internal buffer has no user purpose.
- **Factory defaults:** Cancel/OK – returns all device settings to factory defaults
- **Standby:** Off/10 sec/30 sec/1 min – switches off the screen after the defined period (without user action) and keeps all other operating modes active to save battery power and affect driving as little as possible. Pressing the display controls wakes the device up.
- **LED settings:** n/a for this model
- **Version:** software version.

Parking mode

A special mode for creating a short 20s video recording in case your car is hit while parked in order to capture the offender. This mode activates even when the camera is turned off. The letter "P" is displayed in the top right corner of the screen to symbolize parking mode is active.

Activating parking mode:

- 1) **Device settings** – shock sensitivity option (low, medium or high), select Parking mode Off to disable this option.
- 2) **Operating mode** – press the On/Off button shortly (press On/Off shortly again).

Potential issues:

- a) When the battery power is low, the camera will begin to start, detects the low battery and switches off again. Maintain the battery charged.
- b) The camera can start when you enter the car without immediately inserting the key into the ignition. The key is inserted into the ignition only after 20s of recording and turning off the camera. The camera will finish the switch off process and will not restart. Switch the camera on manually.
- c) With the ignition on during an active recording process after a longer stop. This is a conflict between the automatic internal deactivation and automatic external activation.

3. Troubleshooting:

Please read before contacting your dealer or repair centre.

- Photos and recordings cannot be taken.
Check the inserted card to determine it is functional and has enough free capacity or that the card does not have an overwrite lock applied.
- The recording process stops by itself.
Check the integrity of the inserted card, format it in the device or use a different card, preferably a faster one.
- "File Error" appears when playing a video or viewing photos.
The file is corrupted due to the memory card, try formatting the card or replace it with a new one.
- Blurred image
Check whether the lens is dirty, and if necessary, clean the lens using fine means, which you would also use, for example, to clean your glasses.
- The image is dark, even though the scene is bright (sky, water).
The device attempts to automatically balance scenes with a high contrast. Adjust the measurement and EV sensitivity.
- The colours of photos are not true even in daylight.
Check the white balance in Settings.
- Stripes in the image
The scene contains light with a frequency of 50 Hz or 60 Hz, based on your network. Adjust the frequency in Settings to compensate for stripes.
- The device SW stopped.
Press Reset to restart the device.

4. Technical data

| | |
|--------------------|--|
| LCD display | 2.7", 960×240, LCD |
| Lens | Super wide angle high resolution |
| OSD languages | Eng, Cze, Svk, Pol, Hun, Ger, Rus, Fra |
| Video size | 1080P/720P/480P |
| Video format/codec | AVI (MJPEG) |
| Picture resolution | 12M/10M/8M/5M/3M |
| Picture format | JPG |
| Memory card | MicroSD, max. 32 GB, min Class4, opt. Class 10 |
| Microphone/Speaker | Embedded |
| Mains frequency | 50 Hz/60 Hz |
| USB port | USB 2.0 |
| Power | 5 V 500 mA |
| Battery | 3.7 V Polymer |
| PC system | Windows 2000/XP/Vista/Windows 7 and higher |

Note: We reserve the right to make updates for better performance or adaptations without prior notice.

The original version is in Czech.

Manufacturer address: FAST ČR, a.s., Černokostelecká 1621, Říčany CZ-251 01

INSTRUCTIONS AND INFORMATION REGARDING THE DISPOSAL OF USED PACKAGING MATERIALS

Dispose of packaging material at a public waste disposal site.



DISPOSAL OF USED ELECTRICAL AND ELECTRONIC APPLIANCES

The meaning of the symbol on the product, its accessory or packaging indicates that this product shall not be treated as household waste. Please, dispose of this product at your applicable collection point for the recycling of electrical & electronic equipment waste. Alternatively in some states of the European Union or other European states you may return your products to your local retailer when buying an equivalent new product.

The correct disposal of this product will help save valuable natural resources and help in preventing the potential negative impact on the environment and human health, which could be caused as a result of improper liquidation of waste. Please ask your local authorities or the nearest waste collection centre for further details. The improper disposal of this type of waste may fall subject to national regulations for fines.

For business entities in the European Union

If you wish to dispose of an electrical or electronic device, request the necessary information from your seller or supplier.

Disposal in other countries outside the European Union

If you wish to dispose of this product, request the necessary information about the correct disposal method from local government departments or from your seller.



This appliance complies with EU rules and regulations regarding electromagnetic and electrical safety.

Changes to the text, design and technical specifications may occur without prior notice and we reserve the right to make these changes.

SENCOR®

EN Warranty conditions

Warranty card is not a part of the device packaging.

This product is warranted for the period of 24 months from the date of purchase to the end-user. Warranty is limited to the following conditions. Warranty is referred only to the customer goods using for common domestic use. The claim for service can be applied either at dealer's shop where the product was bought, or at below mentioned authorized service shops. The end-user is obligated to set up a claim immediately when the defects appeared but only till the end of warranty period. The end user is obligated to cooperate to certify the claiming defects. Only completed and clean (according to hygienic standards) product will be accepted. In case of eligible warranty claim the warranty period will be prolonged by the period from the date of claim application till the date of taking over the product by end-user, or the date the end-user is obligated to take it over. To obtain the service under this warranty, end-user is obligated to certify his claim with duly completed following documents: receipt, certificate of warranty, certificate of installation.

This warranty is void especially if apply as follows:

- Defects which were put on sale.
- Wear-out or damage caused by common use.
- The product was damaged by unprofessional or wrong installation, used in contrary to the applicable instruction manual, used in contrary to legal enactment and common process of use or used for another purpose which has been designed for.
- The product was damaged by uncared-for or insufficient maintenance.
- The product was damaged by dirt, accident of force majeure (natural disaster, fire, and flood).
- Defects on functionality caused by low duality of signal, electromagnetic field interference etc.
- The product was mechanically damaged (e.g. broken button, fall).
- Damage caused by use of unsuitable media, fillings, expendable supplies (batteries) or by unsuitable working conditions (e.g. high temperatures, high humidity, quakes).
- Repair, modification or other failure action to the product by unauthorized person.
- End-user did not prove enough his right to claim (time and place of purchase).
- Data on presented documents differs from data on products.
- Cases when the claiming product cannot be identified according to the presented documents (e.g. the serial number or the warranty seal has been damaged).

Authorized service centers

Visit www.sencor.eu for detailed information about authorized service centers.

SENCOR®

Let's live!



Designed in Europe by Sencor®, Made in China

 www.sencor.cz

